

## Product Summary

B320/B330/B340

V <sub>RRM</sub> (V)	I <sub>O</sub> (A)	V <sub>F</sub> max (V)	I <sub>R</sub> max (mA)
20/30/40	3.0	0.5	0.1

B350/B360

V <sub>RRM</sub> (V)	I <sub>O</sub> (A)	V <sub>F</sub> max (V)	I <sub>R</sub> max (mA)
50/60	3.0	0.7	0.1

## Description and Applications

This Schottky Barrier Rectifier has been designed to meet the general requirements of commercial applications. It is ideally suited for use as:

- Polarity Protection Diode
- Re-Circulating Diode
- Switching Diode

## Features and Benefits

- Guard Ring Die Construction for Transient Protection
- Ideally Suited for Automated Assembly
- Low Power Loss, High Efficiency
- Surge Overload Rating to 125A Peak
- For Use in Low Voltage, High Frequency Inverters, Free Wheeling, and Polarity Protection Application
- **Lead-Free Finish; RoHS Compliant (Notes 1 & 2)**
- **Halogen and Antimony Free. "Green" Device (Note 3)**

## Mechanical Data

- Case: SMC
- Case Material: Molded Plastic, "Green" Molding Compound. UL Flammability Classification Rating 94V-0
- Moisture Sensitivity: Level 1 per J-STD-020
- Terminals: Lead Free Plating (Matte Tin Finish). Solderable per MIL-STD-202, Method 208③
- Polarity: Cathode Band
- Weight: 0.21 grams (Approximate)

SMC

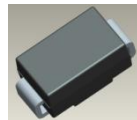

Top View

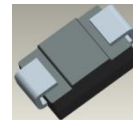

Bottom View

## Ordering Information (Notes 4 & 5)

Part Number	Compliance	Case	Packaging
B3x0-13-F	Commercial	SMC	3,000/Tape & Reel

- Notes:
1. EU Directive 2002/95/EC (RoHS) & 2011/65/EU (RoHS 2) compliant. All applicable RoHS exemptions applied.
  2. See [http://www.diodes.com/quality/lead\\_free.html](http://www.diodes.com/quality/lead_free.html) for more information about Diodes Incorporated's definitions of Halogen- and Antimony-free, "Green" and Lead-free.
  3. Halogen- and Antimony-free "Green" products are defined as those which contain <900ppm bromine, <900ppm chlorine (<1500ppm total Br + Cl) and <1000ppm antimony compounds.
  4. For packaging details, go to our website at <http://www.diodes.com/products/packages.html>.

## Marking Information (Note 5)

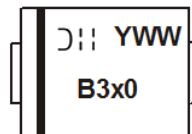

B3x0 = Product Type Marking Code, ex: B320  
 011 = Manufacturers' Code Marking  
 YWW = Date Code Marking  
 Y = Last Digit of Year (ex: 15 for 2015)  
 WW = Week Code (01 to 53)

Note: 5. Device has a cathode band (as shown above) and may also have a cathode notch.

### Maximum Ratings (@T<sub>A</sub> = +25°C, unless otherwise specified.)

Single phase, half wave, 60Hz, resistive or inductive load.  
For capacitance load, derate current by 20%.

Characteristic	Symbol	B320	B330	B340	B350	B360	Unit
Peak Repetitive Reverse Voltage	V <sub>RRM</sub>	20	30	40	50	60	V
Working Peak Reverse Voltage	V <sub>RWM</sub>						
DC Blocking Voltage	V <sub>R</sub>						
Average Rectified Output Current	I <sub>O</sub>	3.0					A
Non-Repetitive Peak Forward Surge Current 8.3ms single half sine-wave superimposed on rated load	I <sub>FSM</sub>	100					A

### Thermal Characteristics

Characteristic	Symbol	Value	Unit
Typical Thermal Resistance, Junction to Terminal	R <sub>θJT</sub>	20	°C/W
Typical Thermal Resistance, Junction to Ambient (Note 6)	R <sub>θJA</sub>	90	°C/W
Operating Temperature Range	T <sub>J</sub>	-55 to +150	°C
Storage Temperature Range	T <sub>STG</sub>	-55 to +150	°C

### Electrical Characteristics (@T<sub>A</sub> = +25°C, unless otherwise specified.)

Characteristic	Symbol	Min	Typ	Max	Unit	Test Condition
Forward Voltage Drop	V <sub>F</sub>	—	—	0.50 0.70	V	B320, B330, B340 B350, B360 I <sub>F</sub> = 3.0A, T <sub>A</sub> = +25°C
Leakage Current (Note 7)	I <sub>R</sub>	—	—	0.1 20	mA	@ Rated V <sub>R</sub> , T <sub>A</sub> = +25°C @ Rated V <sub>R</sub> , T <sub>A</sub> = +100°C
Total Capacitance	C <sub>T</sub>	—	—	200	pF	V <sub>R</sub> = 4V, f = 1MHz

Notes: 6. Thermal Resistance: Junction to terminal, unit mounted on glass epoxy substrate with 2 x 3mm copper pad.  
7. Short duration pulse test used to minimize self-heating effect.

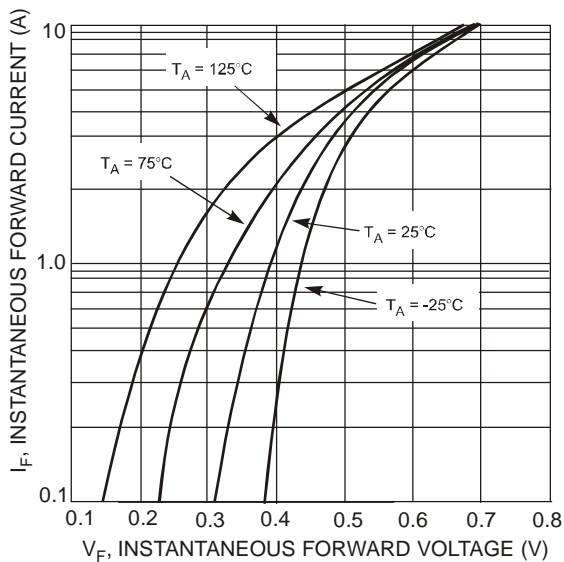

Fig. 1 Typical Forward Characteristics - B320B thru B340B

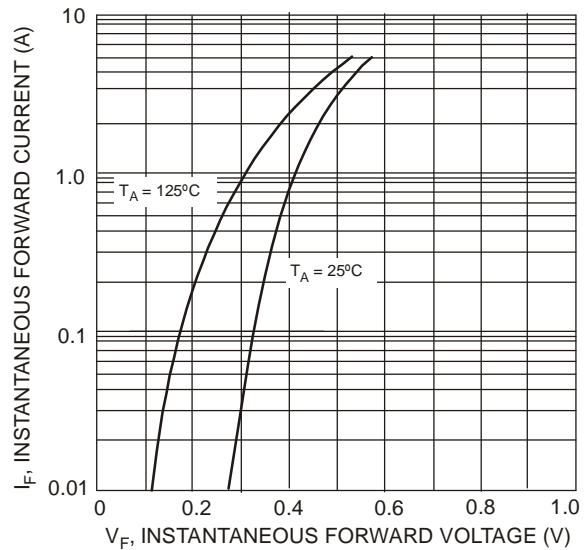

Fig. 2 Typical Forward Characteristics - B350B thru B360B

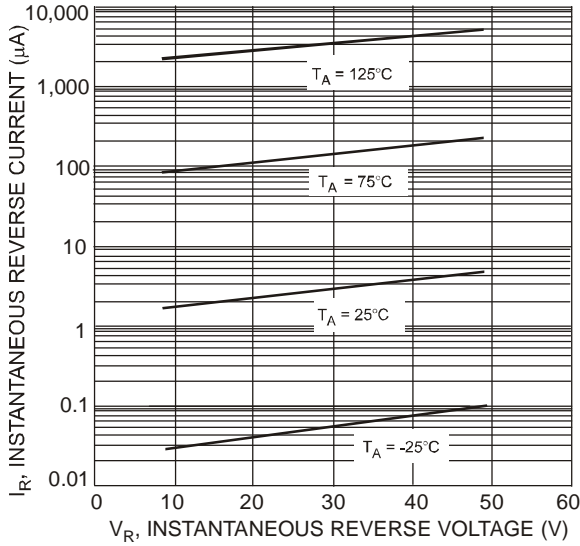

Fig. 3 Typical Reverse Characteristics, B320B thru B340B

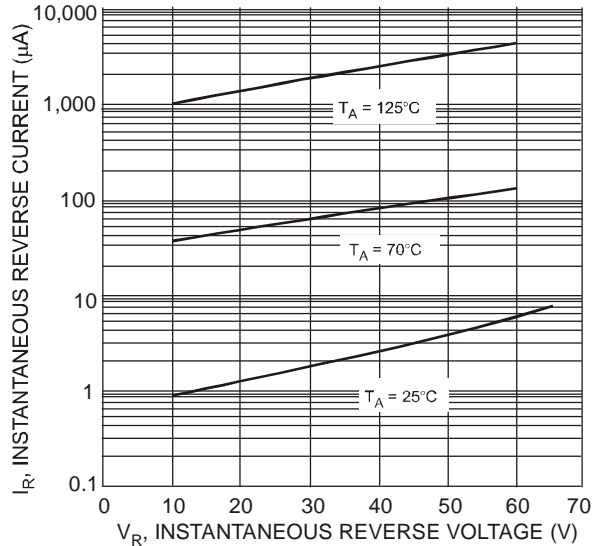

Fig. 4 Typical Reverse Characteristics, B350B thru B360B

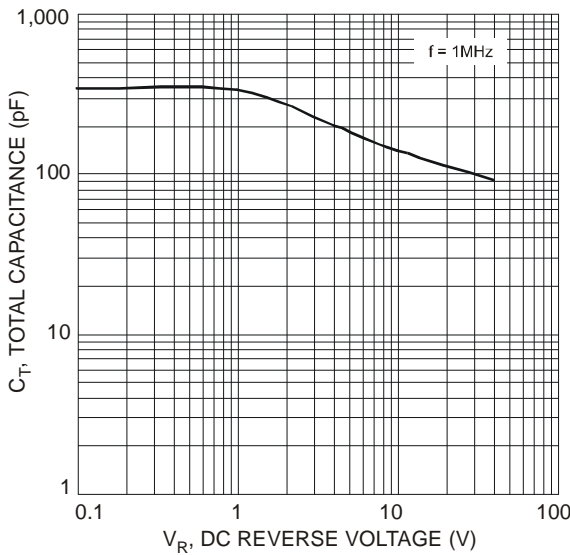

Fig. 5 Total Capacitance vs. Reverse Voltage

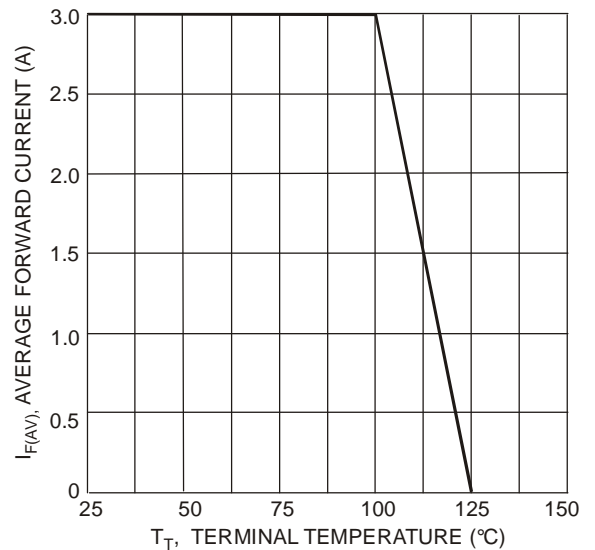

Fig. 6 Forward Current Derating Curve

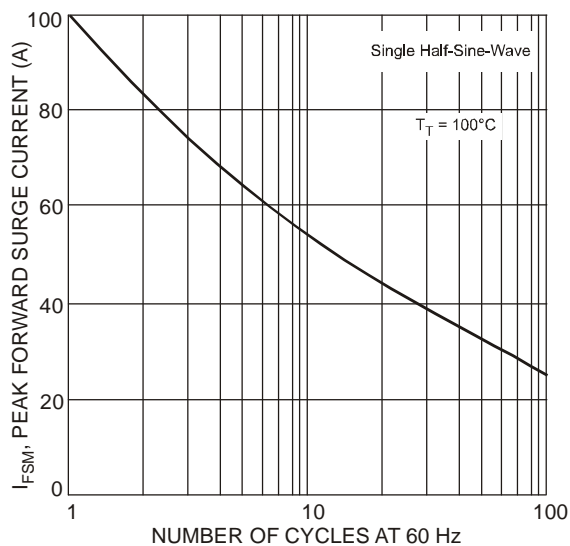
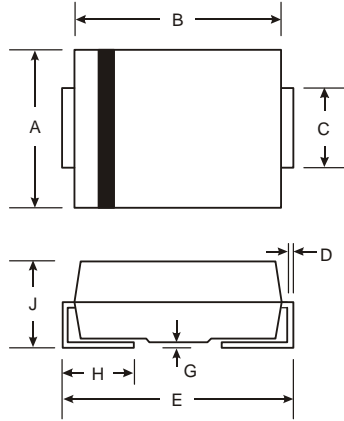

Fig. 7 Max Non-Repetitive Peak Forward Surge Current

**Package Outline Dimensions**

Please see AP02001 at [http://www.diodes.com/\\_files/datasheets/ap02001.pdf](http://www.diodes.com/_files/datasheets/ap02001.pdf) for the latest version.



SMC		
Dim	Min	Max
A	5.59	6.22
B	6.60	7.11
C	2.75	3.18
D	0.15	0.31
E	7.75	8.13
G	0.10	0.20
H	0.76	1.52
J	2.00	2.50
All Dimensions in mm		

**Suggested Pad Layout**

Please see AP02001 at [http://www.diodes.com/\\_files/datasheets/ap02001.pdf](http://www.diodes.com/_files/datasheets/ap02001.pdf) for the latest version.

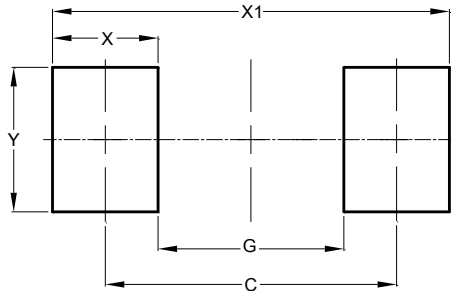

Dimensions	Value (in mm)
C	6.90
G	4.40
X	2.50
X1	9.40
Y	3.30

**IMPORTANT NOTICE**

DIODES INCORPORATED MAKES NO WARRANTY OF ANY KIND, EXPRESS OR IMPLIED, WITH REGARDS TO THIS DOCUMENT, INCLUDING, BUT NOT LIMITED TO, THE IMPLIED WARRANTIES OF MERCHANTABILITY AND FITNESS FOR A PARTICULAR PURPOSE (AND THEIR EQUIVALENTS UNDER THE LAWS OF ANY JURISDICTION).

Diodes Incorporated and its subsidiaries reserve the right to make modifications, enhancements, improvements, corrections or other changes without further notice to this document and any product described herein. Diodes Incorporated does not assume any liability arising out of the application or use of this document or any product described herein; neither does Diodes Incorporated convey any license under its patent or trademark rights, nor the rights of others. Any Customer or user of this document or products described herein in such applications shall assume all risks of such use and will agree to hold Diodes Incorporated and all the companies whose products are represented on Diodes Incorporated website, harmless against all damages.

Diodes Incorporated does not warrant or accept any liability whatsoever in respect of any products purchased through unauthorized sales channel. Should Customers purchase or use Diodes Incorporated products for any unintended or unauthorized application, Customers shall indemnify and hold Diodes Incorporated and its representatives harmless against all claims, damages, expenses, and attorney fees arising out of, directly or indirectly, any claim of personal injury or death associated with such unintended or unauthorized application.

Products described herein may be covered by one or more United States, international or foreign patents pending. Product names and markings noted herein may also be covered by one or more United States, international or foreign trademarks.

This document is written in English but may be translated into multiple languages for reference. Only the English version of this document is the final and determinative format released by Diodes Incorporated.

**LIFE SUPPORT**

Diodes Incorporated products are specifically not authorized for use as critical components in life support devices or systems without the express written approval of the Chief Executive Officer of Diodes Incorporated. As used herein:

A. Life support devices or systems are devices or systems which:

1. are intended to implant into the body, or
2. support or sustain life and whose failure to perform when properly used in accordance with instructions for use provided in the labeling can be reasonably expected to result in significant injury to the user.

B. A critical component is any component in a life support device or system whose failure to perform can be reasonably expected to cause the failure of the life support device or to affect its safety or effectiveness.

Customers represent that they have all necessary expertise in the safety and regulatory ramifications of their life support devices or systems, and acknowledge and agree that they are solely responsible for all legal, regulatory and safety-related requirements concerning their products and any use of Diodes Incorporated products in such safety-critical, life support devices or systems, notwithstanding any devices- or systems-related information or support that may be provided by Diodes Incorporated. Further, Customers must fully indemnify Diodes Incorporated and its representatives against any damages arising out of the use of Diodes Incorporated products in such safety-critical, life support devices or systems.

Copyright © 2016, Diodes Incorporated

**[www.diodes.com](http://www.diodes.com)**