

# RK09Y11L 9mm Size Insulated Shaft Long-life Type

A compact long-life type with a rotational life of 1 million cycles

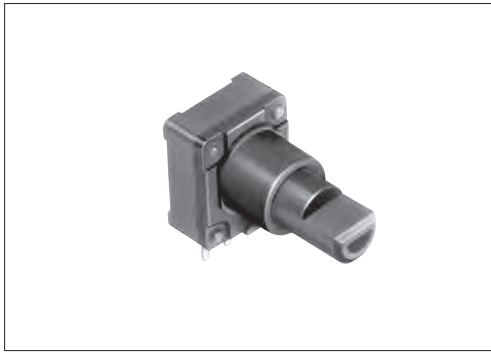

## Typical Specifications

Items	Specifications
Total resistance tolerance	±30%
Maximum operating voltage	50V AC, 5V DC
Total rotational angle	300° ±5° (Effective electrical rotational angle : 60° ±5°)
Rotational torque	5mN·m max.
Operating life	1,000,000 cycles
Operating temperature range	-10°C to +70°C

## Product Line

Number of resistor elements	Shaft type	Length of the shaft (mm)	Total resistance (k Ω)	Resistance taper	Minimum order unit (pcs.)		Products No.
					Japan	Export	
Single-unit	Flat	12	10	B	3,500	7,000	<b>RK09Y11L0001</b>

## Packing Specifications

Bulk

Number of packages (pcs.)		Export package measurements (mm)
1 case / Japan	1 case / export packing	
3,500	7,000	528×369×178

## Dimensions











Unit:mm

Style	PC board mounting hole dimensions (Viewed from mounting side)
<p>Mounting surface</p> <p>Shaft shown in center position</p>	<p>3-ø1 hole</p> <p>Mounting surface</p>

Refer to P.331 for soldering conditions.  
Refer to P.388 for Resistance taper

# Insulated Shaft Potentiometers

## List of Varieties

Type	9mm size		11mm size	12mm size	14mm size	
Series	<b>RK09K11</b> <b>RK09D11</b>	<b>RK09Y11L</b>	<b>RK11K</b>	<b>RK12L12</b>	<b>RK14K</b>	
	Single-unit	Single-unit	Single-unit	Dual-unit	Dual-unit	
Photo						
Control part orientation	Vertical / Horizontal		Horizontal	Vertical / Horizontal		
Bushing	Without		With	Without	With	
Operating temperature range	-10°C to +70°C					
Operating life	5,000 cycles	1,000,000 cycles	15,000 cycles			
Available for automotive use	—	—	—	—	—	
Life cycle						
Electrical performance	Total resistance (k Ω)	5, 10, 20, 50, 100, 200	10	5, 10, 20, 50, 100, 200		
	Resistance taper	15A, 1B, 3B, 15C	B	15A, 1B, 3B, 15C		
	Total resistance tolerance	±20%	±30%	±20%		
	Rated power	0.05W	0.01W	0.05W		
	Maximum operating voltage	50V AC 20V DC	50V AC 5V DC	50V AC 20V DC	50V AC for AC only	
	Gang error	—	—	—	For volume control -40dB to 0dB 3dB max. For tone control within 2dB max. at center	
	Insulation resistance	100MΩ min. 250V DC		100MΩ min. 500V DC	100MΩ min. 250V DC	
	Voltage proof	250V AC for 1minute		500V AC for 1minute	300V AC for 1minute	
	Center-taps	Without		Without / With	Without	Without / With (Volume control)
Mechanical performance	Detent	Without, Center	Without	Without, Center	Without	Without, Center
	Stopper strength	0.3N·m	—	Without bushing 0.5N·m With bushing 0.6N·m	0.5N·m	0.6N·m
	Push-pull strength	50N max.	30N max.	80N max.		
	Vibration	10 to 55 to 10Hz/min., the amplitude is 1.5mm for all the frequencies, in the 3 direction of X, Y and Z and for 2 hours respectively				
Shaft configuration	Flat type, Knob type, Screwdriver type		Flat type			
Terminal style	Insertion					
Page	313 329 (for Mixers)	318	319 329 (for Mixers)	322 329 (for Mixers)	325 329 (for Mixers)	

Insulated Shaft Potentiometers Soldering Conditions	331
Potentiometers Cautions	384
Potentiometers Measurement and Test Methods	386
Potentiometers Resistance Taper	388

### Note

● Indicates applicability to all products in the series.

Rotary Potentiometers

Slide Potentiometers

Metal Shaft

Insulated Shaft

Knob Operating

Through Shaft Type

Ring Type

## ■ Reference for Manual Soldering

Series	Tip temperature	Soldering time	No. of solders
<b>RK09D, RK09K, RK09Y11L, RK11K, RK12L, RK14K</b>	350°C max.	3s max.	1 time

## ■ Reference for Dip Soldering

Series	Preheating		Dip soldering		No. of solders
	Soldering surface temperature	Heating time	Soldering temperature	Soldering time	
<b>RK12L</b>	100°C	1 min. max.	260°C max.	5s max.	2 time max.

# Mouser Electronics

Authorized Distributor

Click to View Pricing, Inventory, Delivery & Lifecycle Information:

[Alps Alpine:](#)

[RK09Y11L0001](#)