

**Roundline Cylinders**  
**Magnetic Piston**  
**Double Acting**  
 $\varnothing$  8 to 63 mm

- **Very compact and shorter than the basic length of a corresponding ISO/VDMA and roundline cylinder.**
- **Magnetic piston as standard provides a wide range of control options.**
- **Comprehensive range of standard stroke lengths.**
- **International series available world-wide.**



### Technical Data

Medium:

Compressed air, filtered, lubricated or non-lubricated

Operation:

Double acting with buffer cushioning

RT/57200/M Side port, integral eye mounting ( $\varnothing$  8 to 40 mm), fixing holes in the end cover ( $\varnothing$  50 and 63 mm)

RT/57200/MC Central rear port ( $\varnothing$  8 to 40 mm)

RT/57200/MF Flat rear cover ( $\varnothing$  8 to 40 mm)

Operating Pressure:

1 to 10 bar

Operating Temperature:

-5°C\* to +80°C max.

\*Consult our Technical Service for use below +2°C

Cylinder Diameters:

8, 10, 12, 16, 20, 25, 32, 40, 50, 63 mm

Standard Strokes:

10, 25, 40, 50, 80, 100 mm  $\varnothing$  8 and 10 mm

10, 25, 40, 50, 80, 100, 125, 160, 200 mm  $\varnothing$  12 and 16 mm

10, 25, 40, 50, 80, 100, 125, 160, 200, 250, 320 mm  $\varnothing$  20 and 25 mm

25, 40, 50, 80, 100, 125, 160, 200, 250, 320 mm  $\varnothing$  32 to 63 mm

Materials:

Stainless steel (8 to 16 mm bore Austenitic, 20 to 63 mm bore Martensitic) piston rod, Stainless steel (Austenitic) barrel, aluminium end covers, polyurethane wiper, nitrile rubber seals and 'O'-rings.

### Alternative Cylinders:

See page N 1.5.041.02

### Ordering Information

To order a basic 40 mm bore cylinder with a 50 mm stroke

quote: RT/57240/M/50

To order a basic 25 mm bore cylinder (central rear port in the end cover) with a 200 mm stroke

quote: RT/57225/MC/200

To order mounting brackets refer to appropriate cylinder and switch mounting table.

Order magnetically operated switches separately.

### Accessories

See page

Switches QM/45/RAP, QM/45/LAP

QM/45/LSU

N 4.3.045.01

Switch QM/45/EAP

N 4.3.047.01

Switches QM/33, QM/34

N 4.3.051.01

Switches QM/134, QM/134/N

N 4.3.055.01

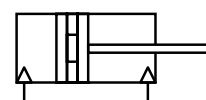

Magnetic piston

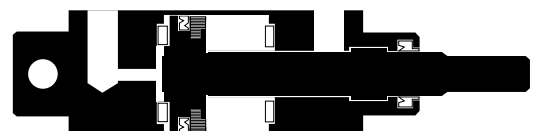











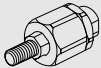

### Alternative Cylinders

Symbol	Model (magnetic piston)	Description
	RT/57200/JM	Double ended piston rod (16 to 63 mm bore)

### Weight of Cylinders • Theoretical Forces • Air Consumption

Model	Weight (kg)		Theoretical forces (N) at 6 bar		Air consumption (l/cm stroke) at 6 bar	
	at 0 mm	per 100 mm	Outstroke	Instroke	Instroke	Outstroke
57208	0,015	0,019	30	25,9	0,004	0,003
57210	0,020	0,027	46,8	39,6	0,005	0,004
57212	0,020	0,030	67,8	60	0,008	0,006
57216	0,040	0,048	120	103	0,014	0,013
57220	0,080	0,072	188	158	0,022	0,019
57225	0,120	0,110	294	247	0,035	0,028
57232	0,210	0,154	482	414	0,056	0,048
57240	0,330	0,201	754	661	0,087	0,074
57250	0,550	0,310	1178	1057	0,137	0,114
57263	0,890	0,437	1870	1680	0,218	0,195

### Weights of Mountings (kg)

Model										
	Style 'AK'	Style 'C'	Style 'F'	Style 'H'	Style 'L'	Style 'M'	Style 'N'	Style 'N2'	Style 'UF'	Switch bracket
57208	-	0,005	0,003	-	0,003	0,006	0,003	0,001	-	0,001
57210	0,015	0,007	0,010	-	0,010	0,020	0,003	0,001	0,015	0,002
57212	0,015	0,007	0,010	-	0,010	0,020	0,003	0,001	0,015	0,002
57216	0,020	0,016	0,012	-	0,020	0,032	0,010	0,002	0,021	0,005
57220	0,050	0,030	0,020	-	0,020	0,040	0,009	0,003	0,045	0,005
57225	0,200	0,040	0,040	-	0,034	0,074	0,011	0,007	0,080	0,006
57232	0,200	0,060	0,048	-	0,040	0,088	0,017	0,007	0,080	0,007
57240	0,200	0,083	0,090	-	0,086	0,176	0,025	0,010	0,120	0,008
57250	0,200	0,175	0,130	0,050	0,198	0,328	-	0,010	0,120	0,010
57263	0,650	0,294	0,220	0,070	0,318	0,538	-	0,021	0,150	0,012

### Warning

These products are intended for use in industrial compressed air systems only. Do not use these products where pressures and temperatures can exceed those listed under 'Technical Data'.

Before using these products with fluids other than those specified, for non-industrial applications, life-support systems, or other applications not within published specifications, consult NORGREN.

Through misuse, age, or malfunction, components used in fluid power systems can fail in various modes.

The system designer is warned to consider the failure modes of all component parts used in fluid power systems and to provide adequate safeguards to prevent personal injury or damage to equipment in the event of such failure.

**System designers must provide a warning to end users in the system instructional manual if protection against a failure mode cannot be adequately provided.**

System designers and end users are cautioned to review specific warnings found in instruction sheets packed and shipped with these products.



**Basic Dimensions**

**RT/57200/M**

**RT/57200/MC**

**RT/57200/MF**

∅ 8 to 12 mm bore

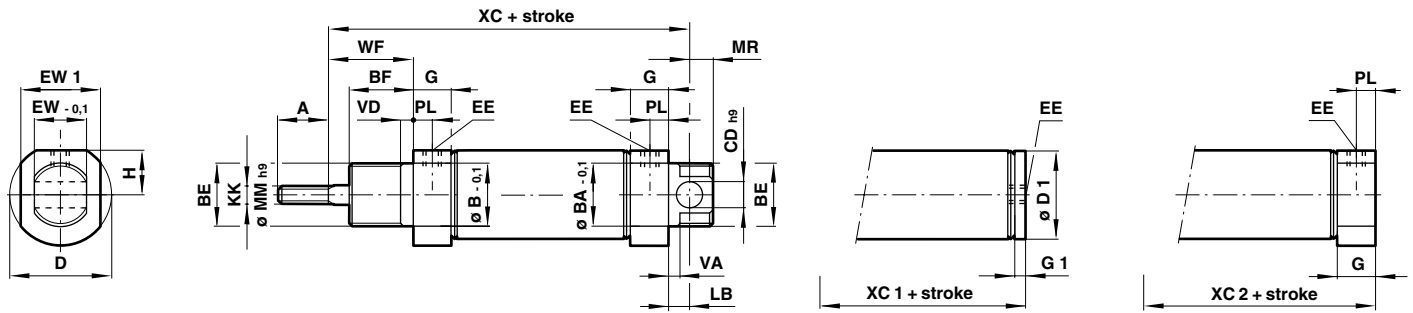

∅ 16 to 40 mm bore

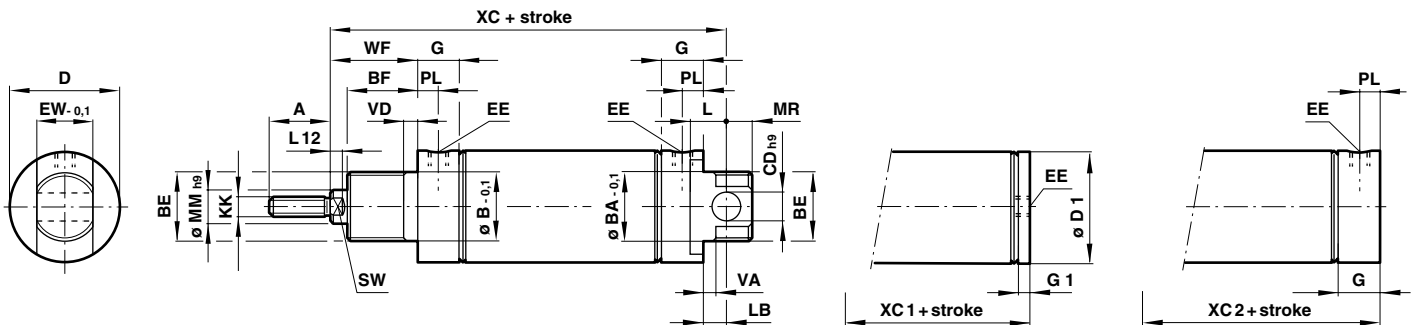

**Double ended piston rod**

**RT/57200/JM**

∅ 16 to 40 mm bore

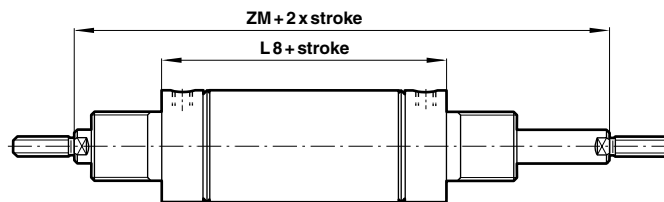

Model	57208	57210	57212	57216	57220	57225	57232	57240
∅	8	10	12	16	20	25	32	40
A	8	9	9	12	14	16	22	23
∅ B/∅ BA	10	10	10	12	16	18	22	30
BE	M 10 x 1	M 10 x 1	M 10 x 1	M 12 x 1,25	M 16 x 1,5	M 18 x 1,5	M 22 x 1,5	M 30 x 1,5
BF	7,5	8	8	10	12	12	15	15
∅ CD h9	3	4	4	5	6	8	8	10
∅ D	12	15	15	17,5	22	26,5	33,5	41,5
∅ D 1	9,5	11,5	13	17,5	21,5	26,5	33,5	41,5
EE	M 3	M 5	M 5	M 5	Rc 1/8	Rc 1/8	Rc 1/8	Rc 1/8
EW - 0,1	6	8	8	10	12	14	16	20
EW 1	10	12,5	-	-	-	-	-	-
G	7,5	9,5	9,5	11,5	15,5	15,5	17,5	18
G 1	3	4,5	4,5	4	8	8	5,5	5,5
H	5	6,5	6,5	-	-	-	-	-
KK	M 3	M 4	M 4	M 6	M 8	M 10 x 1,25	M 10 x 1,25	M 12 x 1,25
L	-	-	-	-	-	-	12	14
LB	4,5	5	5	7	7	9	7	5
L 8	-	-	-	44	53	53	63	67
L 12	-	-	-	5	5	5	5	6
∅ MM h9	3	4	4	6	8	10	12	14
MR	3	4	4	5	6	8	8	10
PL	4	5,5	5,5	5,5	9	9	9	10
SW	-	-	-	5	7	9	10	12
VA/VD	1,5	1,5	1,5	2	3	3	3	3
WF	8,5	10	10	13,5	15,5	16,5	23	24
XC	48	54	54	64,5	75,5	78,5	93	96
XC 1	39	44	44	50	61	62	74	78,5
XC 2	43,5	49	49	57,5	68,5	69,5	86	91
ZM	-	-	-	71	84	86	109	115



**Basic Dimensions RT/57200/M**

∅ 50 and 63 mm bore

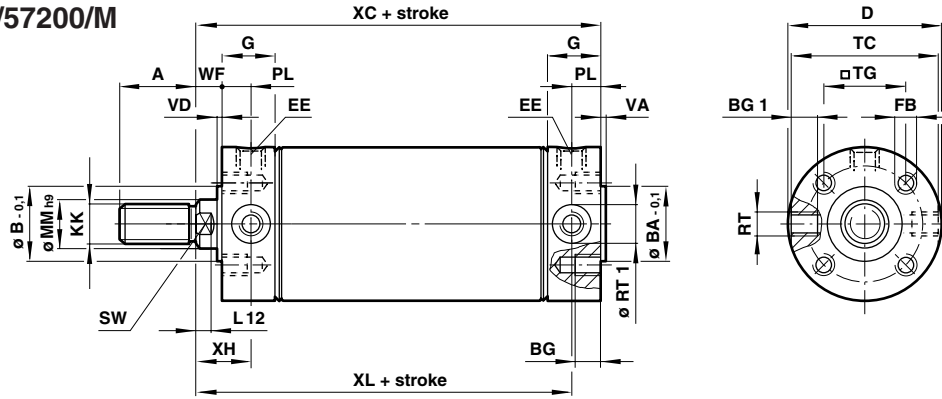

**Double ended piston rod RT/57200/JM**

∅ 50 and 63 mm bore

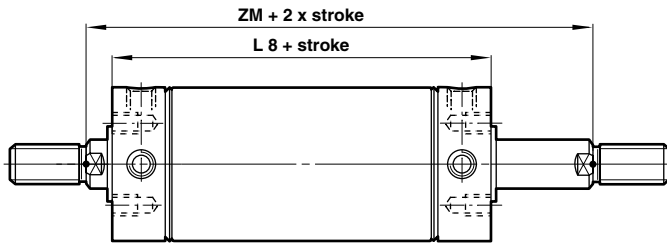

Model	A	∅ B/BA <sup>-0.1</sup>	BG	BG 1	∅ D	EE	FB	G	KK	L 12	L 8	∅ MM h9
57250	23	28	12	8	52,5	Rc 1/4	M 6	22	M 12 x 1,25	7	84	16
57263	30	35	12	9,5	65,5	Rc 1/4	M 8	22	M 16 x 1,5	7	86	20
Model	PL	RT	∅ RT 1	SW	TG	TC	VA/VD	WF	XC	XH	XL	ZM
57250	13	M 10 x 1	13	13	28,5	49	2	13	97	26	84	110
57263	13	M 12 x 1,5	15	17	35,5	62	2	13	99	26	86	112

**End Cover Trunnion Mounting Style 'H'**

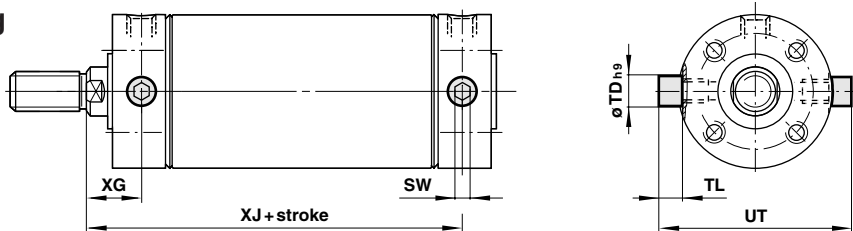

Model	∅	SW	∅ TD h9	TL	UT	XG	XJ
QM/55240/28	50	6	12	9,5	68	26	84
QM/55250/28	63	6	14	11	84	26	86

**Nose Nut Style 'N'**

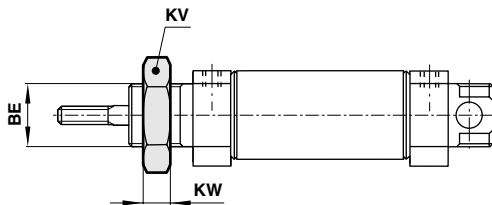

**Locknut Style 'N2'**

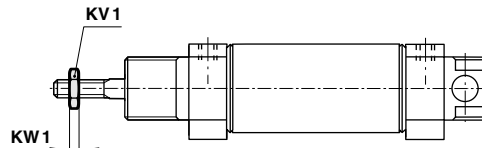

Model 'N'	M/P71364	M/P71364	M/P71364	M/P1501/90	M/P13834	M/P13607	M/P13615	M/P29254		
Model 'N2'	M/P1500/111	M/P1501/80	M/P1501/80	M/P1501/79	M/P1501/60	M/P1501/89	M/P1501/89	M/P1501/90	M/P1501/90	M/P1501/91
∅	8	10	12	16	20	25	32	40	50	63
BE	M 10 x 1	M 10 x 1	M 10 x 1	M 12 x 1,25	M 16 x 1,5	M 18 x 1,5	M 22 x 1,5	M 30 x 1,5	-	-
KV	14	14	14	19	22	24	27	36	-	-
KV 1	6	7	7	10	13	17	17	19	19	24
KW	4	4	4	6	5	5	8	8	-	-
KW 1	2	2	2	3	4	5	5	6	6	8



### Foot Mounting Style 'C'

∅ 8 to 40 mm

∅ 50 and 63 mm

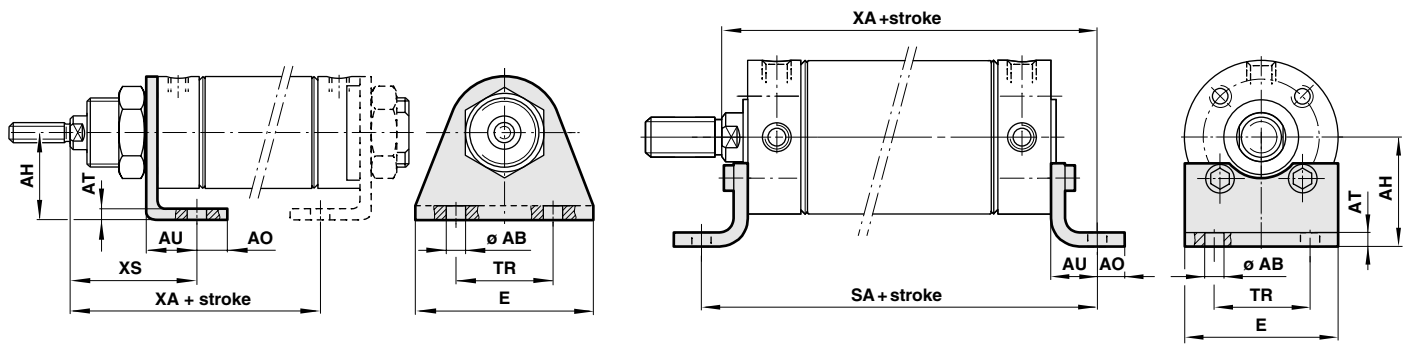

### Front Hinge Mounting Style 'M'

∅ 8 to 40 mm

### Rear Hinge Mounting Style 'L'

∅ 8 to 40 mm

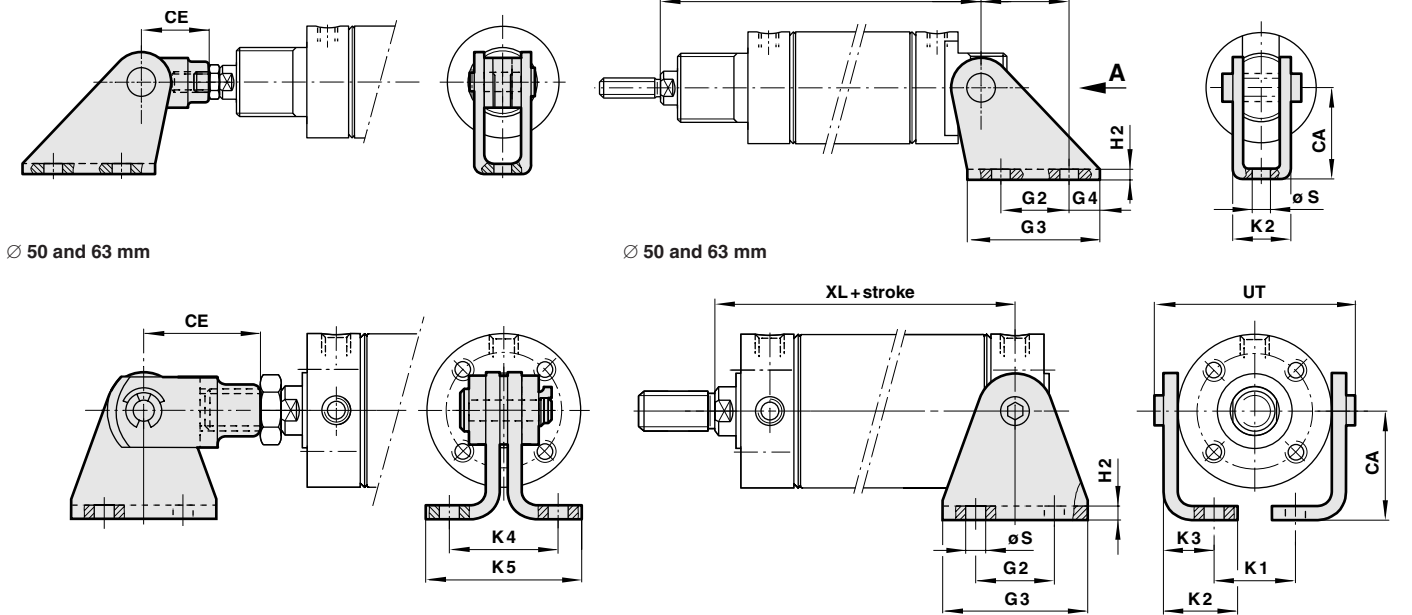

∅ 50 and 63 mm

∅ 50 and 63 mm

Model 'C'	M/P71273/1	M/P71273/2	M/P71273/2	M/P19369	M/P19389	M/P40381	M/P19406	M/P71273/3	QM/57050/21	QM/57063/21
Model 'L'	QM/57008/24	QM/947	QM/947	QM/946	QM/8012/24	QM/57025/24	QM/8020/24	QM/57040/24	QM/57050/24	QM/57063/24
Model 'M'	QM/57008/26	QM/57010/26	QM/57010/26	QM/57016/26	QM/57020/26	QM/57025/26	QM/57032/26	QM/57040/26	QM/57050/26	QM/57063/26
∅	8	10	12	16	20	25	32	40	50	63
∅ AB	3,8	5	5	4,5	5,5	6,6	6,6	7	9	9
AH	10	12	12	16	20	22	25	28	40	47
AO	3,5	4,5	4,5	6	6	8	7,5	7	10	10
AT	1,5	1,5	1,5	2	3	3	4	4	4	5
AU	7,5	7,5	7,5	10	13	12,5	16	16	17	19
CA	10	12	12	16	20	22	25	28	40	47
CE	11	16	16	20	24	26	32	40	48	56
E	25	30	30	35	43	49	53	66	52	61
G 1	9	6,5	6,5	13	18,5	20	20	25		
G 2	7			10	15	15	15	20	30	40
G 3	14			22	30	33	35	42	54	64
G 4	3,5	6	6	6	8	9	10	11		
H 2	1	1	1	1,5	1,5	2	2	3	4	5
K 1									30,5	40,5
K 2	8	10,5	10,5	12,5	15	18	20,5	26	24	26,5
K 3									15	17,5
K 4									34	39
K 5									52	57
TR	18	20	20	25	32	38	40	52	36	45
∅ S	3,5	4,8	4,8	4,8	5,5	6,6	6,6	7	9	9
SA									118	124
UT									68	84
XA	37,5	43	43	49,5	58,5	60	74	79	114	118
XC	48	54	54	64,5	75,5	78,5	93	96	97	99
XL									84	86
XS	14,5	16	16	21,5	25,5	26	35	36		



### Piston Rod Swivel Mounting Style 'AK'

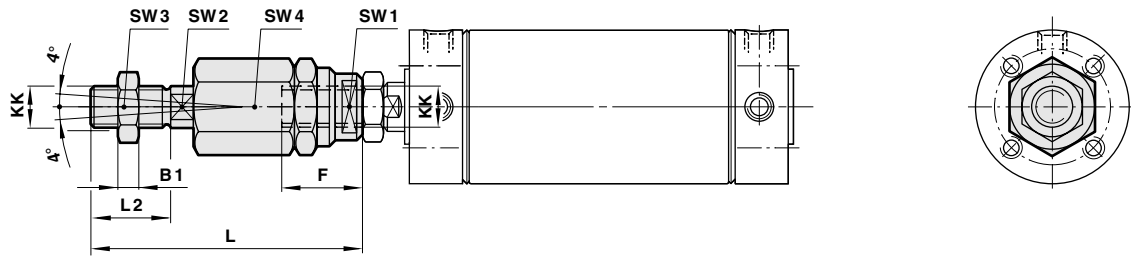

### Piston Rod Clevis Mounting Style 'F'

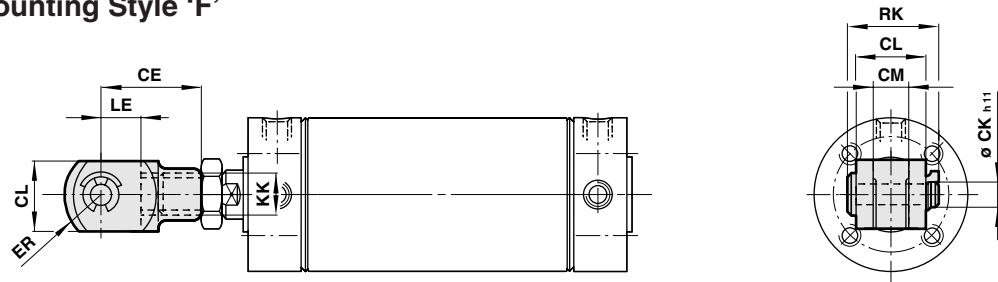

### Universal Piston Rod Eye Mounting Style 'UF'

(Corresponds to DIN ISO 8139)

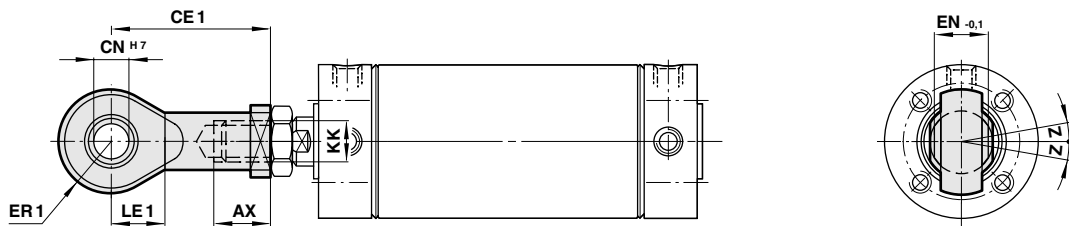

Model 'AK'		QM/8010/38	QM/8010/38	QM/8012/38	QM/8020/38	QM/8025/38	QM/8025/38	QM/8040/38	QM/8040/38	QM/8050/38
Model 'F'	QM/57008/25	QM/8010/25	QM/8010/25	QM/57016/25	QM/57020/25	QM/57025/25	QM/57032/25	QM/57040/25	QM/8040/25	QM/57063/25
Model 'UF'		QM/8010/32	QM/8010/32	QM/8012/32	QM/8020/32	QM/8025/32	QM/8025/32	QM/8040/32	QM/8040/32	QM/8050/32
∅	8	10	12	16	20	25	32	40	50	63
AX		14	14	14	16	20	20	22	22	28
B 1		2	2	3	4	5	5	6	6	8
CE	11	16	16	20	24	26	32	40	48	56
CE 1		27	27	30	36	43	43	50	50	64
∅ CK h11	3 h9	4	4	5	6	8	8	10	12	14
□ CL	6	8	8	10	12	14	16	20	24	27
CM B12	3	4	4	5	6	7	8	10	12	14
∅ CN H7		5	5	6	8	10	10	12	12	16
EN -0,1		8	8	9	12	14	14	16	16	21
ER	4,5	6,5	6,5	8	9,5	11,5	13	16	19	21
ER 1		8	8	9	11	14	14	16	16	21
F		12,5	12,5	14	18	26	26	26	26	34
KK	M 3	M 4	M 4	M 6	M 8	M 10 x 1,25	M 10 x 1,25	M 12 x 1,25	M 12 x 1,25	M 16 x 1,5
L		33	33	39	55	73	73	77	77	106
L 2		8	8	12	16	20	20	24	24	32
LE	5	8	8	10	12	12	16	20	24	28
LE 1		10	10	11	13	15	15	17	17	22
RK	10,3	11,5	11,5	14,5	17,5	20,5	22,5	29	33	36,5
SW 1 (A/F)		11	11	7	10	19	19	19	19	30
SW 2 (A/F)		3,2	3,2	5	7	12	12	12	12	19
SW 3 (A/F)		7	7	10	13	17	17	19	19	24
SW 4 (A/F)		11	11	13	17	30	30	30	30	42
Z		5°	5°	5°	5°	13°	13°	13°	13°	15°



**Brackets for roundline cylinders  $\varnothing$  8 to 25 mm  
Magnetically operated switches QM/45**

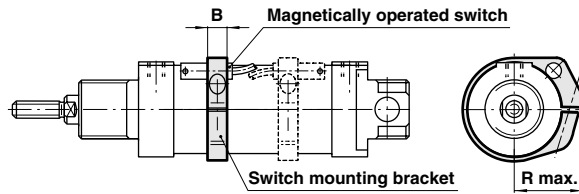

Model	QM/45/208/22	QM/45/210/22	QM/45/212/22	QM/45/216/22	QM/45/220/22	QM/45/225/22
$\varnothing$	8	10	12	16	20	25
B	8	8	8	10	10	10
R max.	13	14	15	18	20	22,5

**Brackets for roundline cylinders  $\varnothing$  32 to 63 mm  
Magnetically operated switches QM/33, QM/34 and QM/134**

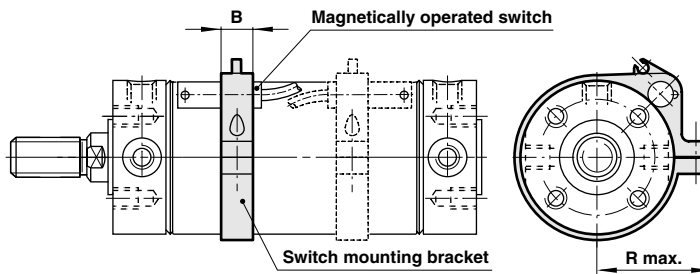

Model	QM/33/032/22	QM/33/040/22	QM/33/050/22	QM/33/063/22		
$\varnothing$	32	40	50	63		
B	10	10	10	10		
R max.	29	32	38	46		