

# Cree® 5-mm Blue and Green Round LED C503B-BCS/BCN/GCS/GCN

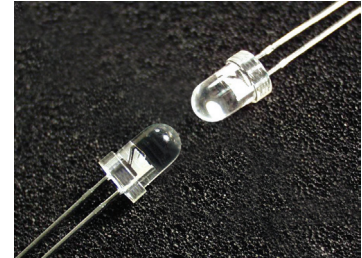

## PRODUCT DESCRIPTION

Round LEDs offer superior light output for excellent readability in sunlight and dependable performance. They provide extremely stable light output over long periods of time.

These lamps are made with an advanced optical-grade epoxy offering superior high-temperature and high-moisture-resistance performance in outdoor signal and sign applications.

## FEATURES

- Size (mm): 5
- Color and Typical Dominant Wavelength:  
Blue (470nm)  
Green(527nm)
- Luminous Intensity (mcd)  
C503B-BCS/BCN:  
(2130-12000)  
C503B-GCS/GCN:  
(5860-32900)
- Viewing angle:  
C503B-BCS/BCN/GCS/GCN:  
30 degree
- Lead - Free
- RoHS Compliant

## APPLICATIONS

- Electronic Signs & Signals (ESS)
- Motorway Signs
- Variable Message Sign (VMS)
- Advertising signs
- Petrol Signs
- Amusement

### ABSOLUTE MAXIMUM RATINGS ( $T_A = 25^\circ\text{C}$ )

Items	Symbol	Absolute Maximum Rating	Unit
		Blue/Green	
Forward Current	$I_F$	30	mA
Peak Forward Current <sup>Note1</sup>	$I_{FP}$	100	mA
Reverse Voltage	$V_R$	5	V
Power Dissipation	$P_D$	120	mW
Operation Temperature	$T_{opr}$	-40 ~ +95	°C
Storage Temperature	$T_{stg}$	-40 ~ +100	°C
Lead Soldering Temperature	$T_{sol}$	Max. 260°C for 3 sec. max. (3 mm from the base of the epoxy bulb)	

**Note:**

1. Pulse width  $\leq 0.1$  msec, duty  $\leq 1/10$ .

### TYPICAL ELECTRICAL & OPTICAL CHARACTERISTICS ( $T_A = 25^\circ\text{C}$ )

Characteristics	Color		Symbol	Condition	Unit	Minimum	Typical	Maximum
Forward Voltage	Blue/Green		$V_F$	$I_F = 20$ mA	V		3.2	4.0
Reverse Current	Blue/Green		$I_R$	$V_R = 5$ V	$\mu\text{A}$			100
Dominant Wavelength	Blue		$\lambda_D$	$I_F = 20$ mA	nm	465	470	480
	Green		$\lambda_D$	$I_F = 20$ mA	nm	520	527	535
Luminous Intensity	Blue	C503B-BCS/BCN (30 degree)	$I_V$	$I_F = 20$ mA	mcd	2130	4800	
	Green	C503B-GCS/GCN (30 degree)	$I_V$	$I_F = 20$ mA	mcd	5860	20000	
50% Power Angle	C503B-BCS/BCN/GCS/GCN		$2\theta_{1/2}$	$I_F = 20$ mA	deg		30	

**Note:** Continuous reverse voltage can cause LED damage.

## INTENSITY BIN LIMIT ( $I_f = 20 \text{ mA}$ )

Blue

C503B-BCS/BCN (30 degree)

Bin Code	Min.(mcd)	Max.(mcd)
V0	2130	3000
W0	3000	4180
X0	4180	5860
Y0	5860	8200
Z0	8200	12000

Green

C503B-GCS/GCN (30 degree)

Bin Code	Min.(mcd)	Max.(mcd)
Y0	5860	8200
Z0	8200	12000
A0	12000	16800
B0	16800	23500
C0	23500	32900

- Tolerance of measurement of luminous intensity is  $\pm 15\%$

## COLOR BIN LIMIT ( $I_f = 20 \text{ mA}$ )

Blue

Bin Code	Min.(nm)	Max.(nm)
B4	465	470
B45	467.5	472.5
B5	470	475
B67	472.5	477.5
B6	475	480

Green

Bin Code	Min.(nm)	Max.(nm)
G7	520	525
G23	522.5	527.5
G8	525	530
G45	527.5	532.5
G9	530	535

- Tolerance of measurement of dominant wavelength is  $\pm 1 \text{ nm}$

### ORDER CODE TABLE\*

Blue (30 degree)

Color	Kit Number	Viewing Angle	Luminous Intensity (mcd)		Dominant Wavelength				Package	Standoff
			Min.	Max.	Color Bin	Min. (nm)	Color Bin	Max. (nm)		
Blue	C503B-BCS-CV0Z0461	30	2130	12000	B4	465	B6	480	Bulk	Yes
Blue	C503B-BCS-CW0X0451	30	3000	5860	B4	465	B5	475	Bulk	Yes
Blue	C503B-BCS-CX0Y0451	30	4180	8200	B4	465	B5	475	Bulk	Yes
Blue	C503B-BCS-CV0Z0462	30	2130	12000	B4	465	B6	480	Ammo	Yes
Blue	C503B-BCS-CW0X0452	30	3000	5860	B4	465	B5	475	Ammo	Yes
Blue	C503B-BCS-CX0Y0452	30	4180	8200	B4	465	B5	475	Ammo	Yes
Blue	C503B-BCN-CV0Z0461	30	2130	12000	B4	465	B6	480	Bulk	No
Blue	C503B-BCN-CW0X0451	30	3000	5860	B4	465	B5	475	Bulk	No
Blue	C503B-BCN-CX0Y0451	30	4180	8200	B4	465	B5	475	Bulk	No
Blue	C503B-BCN-CV0Z0462	30	2130	12000	B4	465	B6	480	Ammo	No
Blue	C503B-BCN-CW0X0452	30	3000	5860	B4	465	B5	475	Ammo	No
Blue	C503B-BCN-CX0Y0452	30	4180	8200	B4	465	B5	475	Ammo	No

## ORDER CODE TABLE\*

Green (30 degree)

Color	Kit Number	Viewing Angle	Luminous Intensity (mcd)		Dominant Wavelength				Package	Standoff
			Min.	Max.	Color Bin	Min. (nm)	Color Bin	Max. (nm)		
Green	C503B-GCS-CY0C0791	30	5860	32900	G7	520	G9	535	Bulk	Yes
Green	C503B-GCS-CA0B0781	30	12000	23500	G7	520	G8	530	Bulk	Yes
Green	C503B-GCS-CA0B0891	30	12000	23500	G8	525	G9	535	Bulk	Yes
Green	C503B-GCS-CB0C0781	30	16800	32900	G7	520	G8	530	Bulk	Yes
Green	C503B-GCS-CB0C0891	30	16800	32900	G8	525	G9	535	Bulk	Yes
Green	C503B-GCS-CY0C0792	30	5860	32900	G7	520	G9	535	Ammo	Yes
Green	C503B-GCS-CA0B0782	30	12000	23500	G7	520	G8	530	Ammo	Yes
Green	C503B-GCS-CA0B0892	30	12000	23500	G8	525	G9	535	Ammo	Yes
Green	C503B-GCS-CB0C0782	30	16800	32900	G7	520	G8	530	Ammo	Yes
Green	C503B-GCS-CB0C0892	30	16800	32900	G8	525	G9	535	Ammo	Yes
Green	C503B-GCN-CY0C0791	30	5860	32900	G7	520	G9	535	Bulk	No
Green	C503B-GCN-CA0B0781	30	12000	23500	G7	520	G8	530	Bulk	No
Green	C503B-GCN-CA0B0891	30	12000	23500	G8	525	G9	535	Bulk	No
Green	C503B-GCN-CB0C0781	30	16800	32900	G7	520	G8	530	Bulk	No
Green	C503B-GCN-CB0C0891	30	16800	32900	G8	525	G9	535	Bulk	No
Green	C503B-GCN-CY0C0792	30	5860	32900	G7	520	G9	535	Ammo	No
Green	C503B-GCN-CA0B0782	30	12000	23500	G7	520	G8	530	Ammo	No
Green	C503B-GCN-CA0B0892	30	12000	23500	G8	525	G9	535	Ammo	No
Green	C503B-GCN-CB0C0782	30	16800	32900	G7	520	G8	530	Ammo	No
Green	C503B-GCN-CB0C0892	30	16800	32900	G8	525	G9	535	Ammo	No

### Notes:

1. The above kit numbers represent order codes that include multiple intensity-bin and color-bin codes. Only one intensity-bin code and one color-bin code will be shipped on each bulk. Single intensity-bin code and single color-bin codes will not be orderable.
2. Please refer to the "Cree LED Lamp Reliability Test Standards" document #1 for reliability test conditions.
3. Please refer to the "Cree LED Lamp Soldering & Handling" document #2 for information about how to use this LED product safely.

#1: Refer to [http://www.cree.com/led-components/media/documents/LED\\_Lamp\\_Reliability\\_Test\\_Standard.pdf](http://www.cree.com/led-components/media/documents/LED_Lamp_Reliability_Test_Standard.pdf)

#2: Refer to <http://www.cree.com/led-components/media/documents/sh-HB.pdf>

## GRAPHS

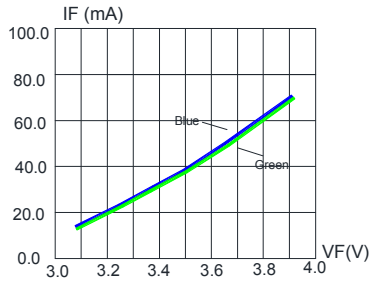

FIG.1 FORWARD CURRENT VS. FORWARD VOLTAGE.

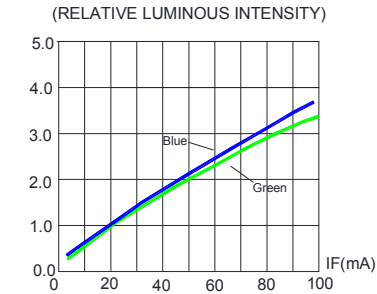

FIG.2 RELATIVE LUMINOUS INTENSITY VS. FORWARD CURRENT

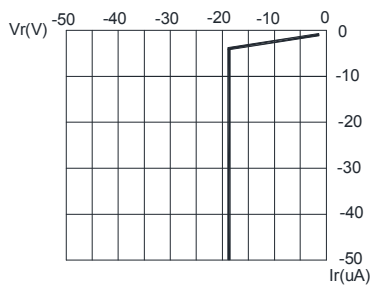

FIG.3 REVERSE CURRENT VS. REVERSE VOLTAGE.

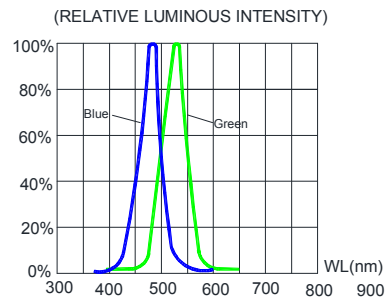

FIG.4 RELATIVE LUMINOUS INTENSITY VS. WAVELENGTH.

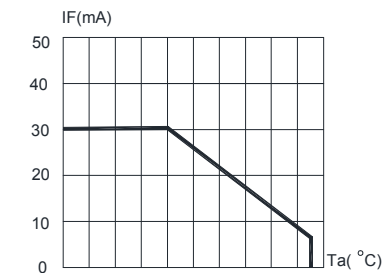

FIG.5 BLUE & GREEN MAXIMUM FORWARD DC CURRENT VS AMBIENT TEMPERATURE (Tjmax=105°C)

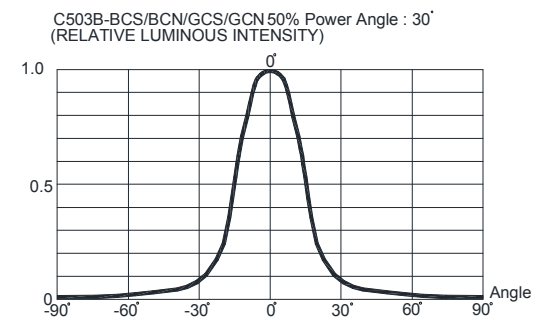

FIG.7 FAR FIELD PATTERN

The above data are collected from statistical figures that do not necessarily correspond to the actual parameters of each single LED. Hence, these data will be changed without further notice.

## MECHANICAL DIMENSIONS

All dimensions are in mm. Tolerance is  $\pm 0.25$  mm unless otherwise noted.

An epoxy meniscus may extend about 1.5 mm down the leads.

Burr around bottom of epoxy may be 0.5 mm max.

C503B-BCN/GCN:

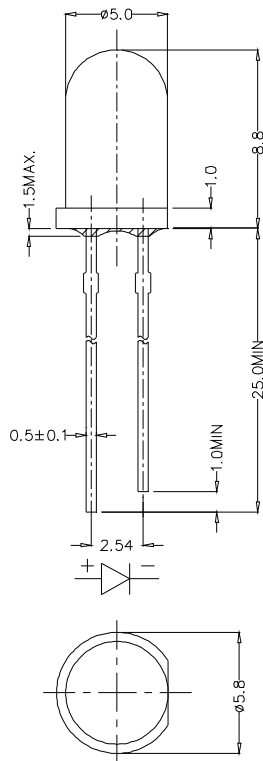

C503B-BCS/GCS:

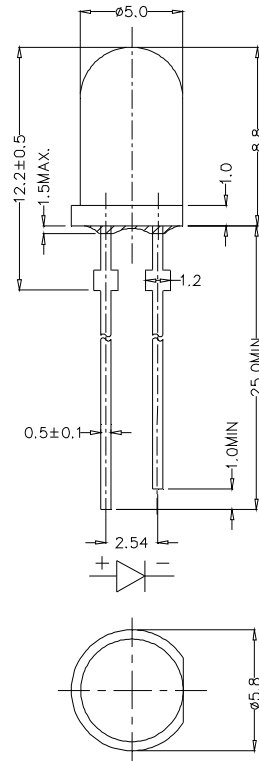

## NOTES

### RoHS Compliance

The levels of RoHS-restricted materials in this product are below the maximum concentration values (also referred to as the threshold limits) permitted for such substances, or are used in an exempted application in accordance with EU Directive 2011/65/EC (RoHS2), as implemented by EU member states on January 2, 2013 and amended on March 31, 2015 by EU Directive 2015/863/EU.

RoHS Declarations for this product can be obtained from your Cree representative or from the Product Ecology section of the Cree website.

### Vision Advisory Claim

Users should be cautioned not to stare at the light of this LED product. The bright light can damage the eye.

## KIT NUMBER SYSTEM

All dimensions in mm. Cree LED lamps are tested and sorted into performance bins. A bin is specified by ranges of color, forward voltage, and brightness. Sorted LEDs are packaged for shipping in various convenient options. Please refer to the "Cree LED Lamp Packaging Standard" document for more information about shipping and packaging options.

Cree LEDs are sold by order codes in combinations of bins called kits. Order codes are configured in the following manner:

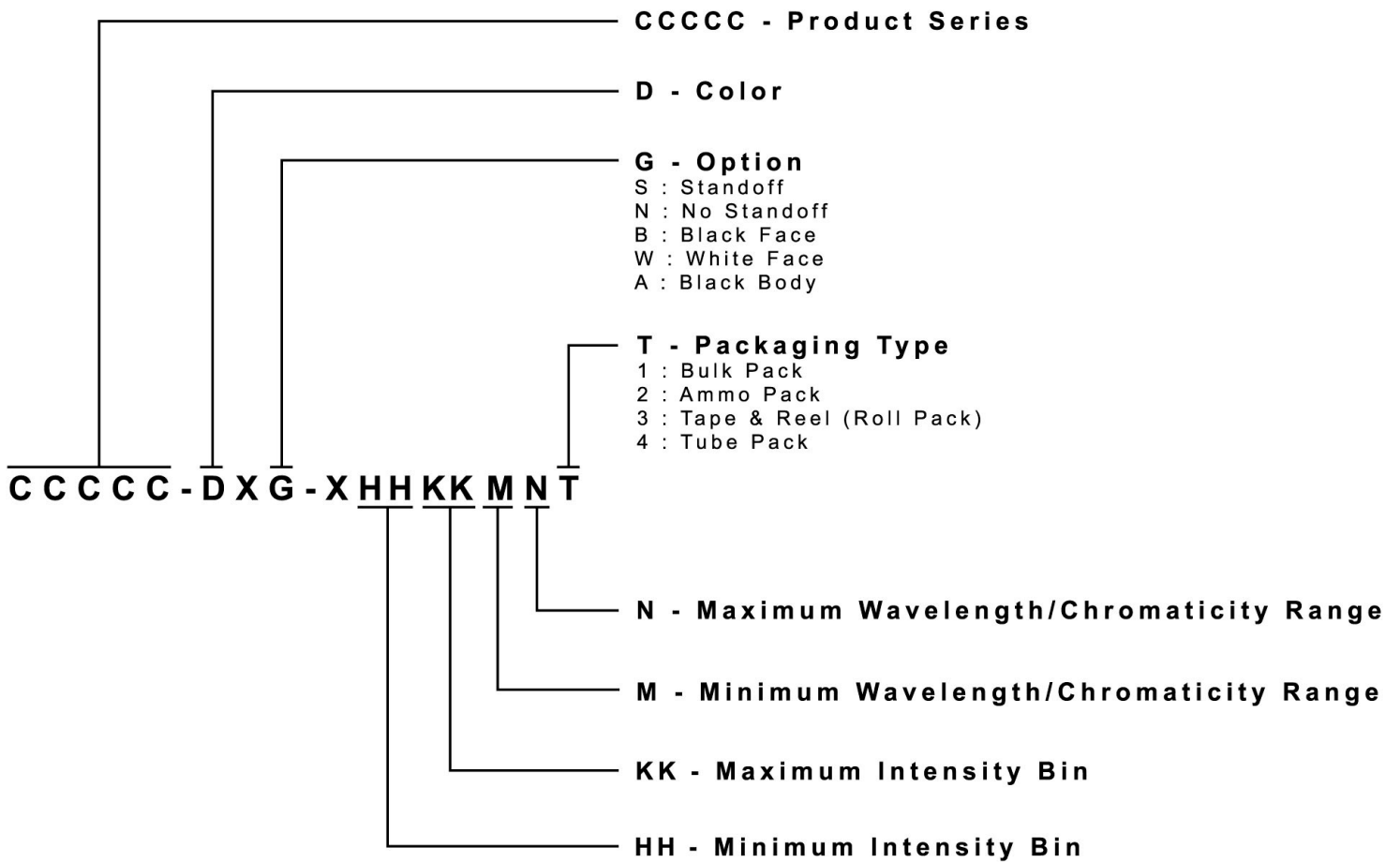



## REFLOW SOLDERING

The LED soldering specification is shown below (suitable for both leaded solder & lead-free solder):

Manual Soldering		Solder Dipping	
Soldering iron	35 W max	Preheat	110 °C max
Temperature	300 °C max	Preheat time	60 seconds max
		Solder-bath temperature	260 °C Max
Soldering time	3 seconds max	Dipping time	5 seconds max
Position	Not less than 3 mm from the base of the package.	Position	Not less than 3 mm from the base of the package.

- Manual soldering onto the PCB is not recommended because soldering time is uncontrollable.
- The recommended wave soldering is as below:



- Do not apply any stress to the LED package, particularly when heated.
- Only bottom preheat is suggested & should not preheat on top in order to reduce thermal stress experienced by the LEDs.
- The LEDs must not be re used once they have been extracted from PCB.
- After soldering the LEDs, the package should be protected from mechanical shock or vibration until the LEDs have reached 40 °C or below.
- Precautions must be taken as mechanical stress on the LEDs may be caused by PCB warpage or from the clinching and cutting of the LED leads.
- When it is necessary to clam the LEDs during soldering, it is important to ensure no mechanical stress is exerted on the LEDs.
- Cut the LED lead at normal room temperature. Lead cutting at high temperature may cause failure of the LEDs.

Refer to "<http://www.cree.com/led-components/media/documents/sh-HB.pdf>" for soldering & handling details.

## PACKAGING

### Features:

- The LEDs are packed in cardboard boxes after packaging in normal or anti-electrostatic bags.
- Cardboard boxes will be used to protect the LEDs from mechanical shock during transportation.
- The boxes are not water resistant, and they must be kept away from water and moisture.
- The Bulk Pack types of packaging.
- Max 500 pcs per bulk and Max 2500 pcs per ammo.

### Bulk Pack Packaging Type:

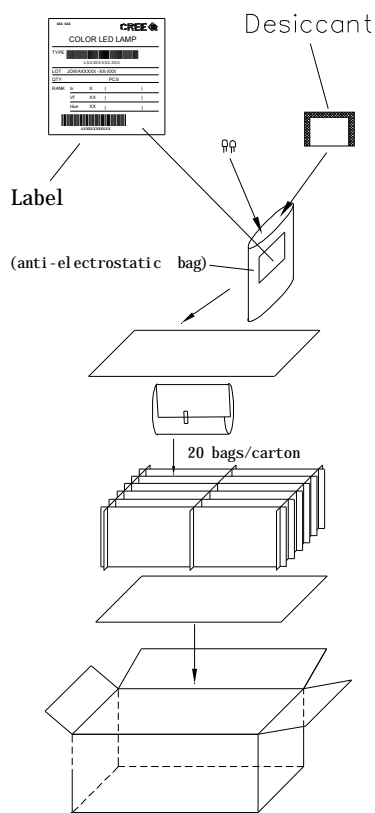

### Ammo Pack Packaging Type:

