

1/32 DIN TEMPERATURE INDICATOR & CONTROLLER CONCISE PRODUCT MANUAL (59227-5)

Note: This symbol indicates that feature / parameter is not available on Indicator Units

FRONT PANEL

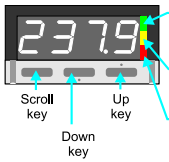

Green: OFF - PV < SP
ON - PV = SP
Flashing - PV > SP

Yellow: OFF - Normal Operation
ON - Control Set-Up Mode
Flashing - Configuration Mode

Red: Flashing - Alarm(s) active

Scroll key
Up key
Down key

NORMAL OPERATION (Yellow LED OFF)

NOTE: Set all Configuration Mode and Setup Mode parameters as desired before starting normal operations.

Use Scroll key to step through parameter display sequence as follows:

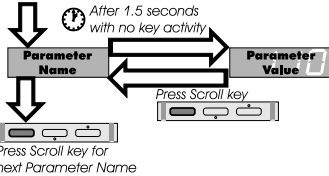

Use Up and Down keys to adjust displayed value.

The parameter display sequence is as follows:

Legend	Meaning	Adjustment Range	Default
PrOc	Process Variable: Read Only display - not adjustable	N/A	N/A
ALSt	Alarm Status: Included in sequence only if two alarms are configured and at least one is active.	N/A	N/A
SP	Setpoint Selection: Included in the sequence only if Dual Setpoint operation is configured.	1 or 2	1
SP1	Setpoint (1) value: adjustable only if setpoint adjustment is enabled (see CONTROL SETUP).	Input Range Min. to Input Range Max.	Input Range Min.
SP2	Setpoint 2 value: included in the sequence only if Dual Setpoint operation is configured; adjustable only if setpoint adjustment is enabled (see CONTROL SETUP).	Input Range Min. to Input Range Max.	Input Range Min.
AL1	Alarm (1) value: Included in the sequence only if access to the alarm display is enabled (see CONTROL SETUP) and an alarm is configured.	Process High: Input Range Min. - Input Range Max. Process Low: Input Range Min. - Input Range Max. Deviation (high or low): -(input span) - +(input span) Band: 1 LSD - input span	Process High alarm, Input Range Max.
AL2	Alarm 2 value: Included in the sequence only if access to the alarm display is enabled (see CONTROL SETUP) and two alarms are configured.	Process High: Input Range Min. - Input Range Max. Process Low: Input Range Min. - Input Range Max. Deviation (high or low): -(input span) - +(input span) Band: 1 LSD - input span	Process Low alarm, Input Range Min.

Easy Tune

If the Controller is configured for Easy Tune operation, all tuning is performed automatically, at each power up.

Manual Tuning with Pre-Tune

If the Controller is configured for manual tuning, a one-shot Pre-Tune can be used to optimise system at any time.

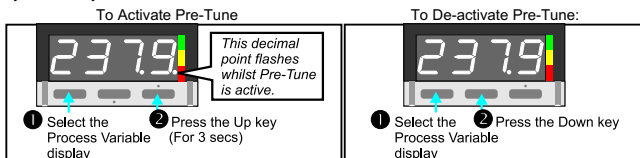

NOTE: Pre-Tune is a single-shot operation and will automatically dis-engage itself after completion of its routine. Pre-Tune will not be activated; (a) if the process variable is within 5% of input span from the setpoint, (b) if the unit is configured for on/off control or (c) if Easy Tune is selected.

CONTROL SET-UP MODE (Yellow LED ON)

Note: Set all Configuration Mode parameters as desired before adjusting Set Up Mode parameters

Entry/Exit

Press the Up and Down keys simultaneously for more than three seconds.

Set Up Mode Parameter Sequence

Parameters are selected and adjusted as described in NORMAL OPERATION.

Legend	Parameter	Adjustment Range	Default
SP1	Setpoint (1) value	Input Range Min. to Input Range Max.	Input Range Min.
SP2	Setpoint 2 value - appears only if Dual Setpoint operation is configured	Input Range Min. to Input Range Max.	Input Range Min.
Pb	Proportional Band value (Only with Manual Tune & PID control)	1.0% to 999.9% in 0.1% increments.	10.0%
RES	Reset (Integral) value (Only with Manual Tune & PID control)	1 second to 99 minutes 59 seconds and OFF (greater than 99 minutes 59 seconds)	5 minutes
RD	Rate (Derivative) value (Only with Manual Tune & PID control)	0 (OFF) to 99 minutes 59 seconds	1 minute 15 seconds
bIAS	Bias (Manual Reset) value (Only with Manual Tune & PID control)	0% to 100%	25%
HYSt	ON/OFF Hysteresis value (Only with On/Off control)	0.1% to 10.0% of input span	0.5% of input span
AL1	Alarm 1 value	Process High: Input Range Min. - Input Range Max. Process Low: Input Range Min. - Input Range Max. Deviation (high or low): -(input span) - +(input span) Band: 1 LSD - input span	Process High alarm, Input Range Max.
AL2	Alarm 2 value	Process High: Input Range Min. - Input Range Max. Process Low: Input Range Min. - Input Range Max. Deviation (high or low): -(input span) - +(input span) Band: 1 LSD - input span	Process Low alarm, Input Range Min.
FiLT	Input Filter Time Constant value	0 seconds to 100 seconds	2 seconds
OFFS	Input Offset value	±input span.	0
CT	Output Cycle Time value	0.5 (SSR drive only), 1, 2, 4, 8, 16, 32, 64, 128, 256 and 512 seconds	16 seconds
SPL	Setpoint Lock	OFF: Setpoint adjustment enabled in Normal Operation. ON: Setpoint adjustment disabled in Normal Operation.	OFF
REn	Disable/enable access to Alarm Value in Normal Operation	EnAb: Display/adjustment enabled in Normal Operation. DiSA: Display/adjustment disabled in Normal Operation.	EnAb

INSTALLATION

CAUTION: This equipment is intended for field installation within the enclosure of another product. Installation and configuration should be performed only by personnel who are technically-competent & authorised to do so. Local Regulations regarding electrical installation & safety must be observed.

Panel Mounting

The mounting panel must be rigid and may be up to 6.0mm (0.25 inches) thick. The cut-out required for the Controller is shown on the right. Controllers may be mounted side-by-side in a multiple installation for which the cut-out width (for n Controllers) is (48n-4)mm or (1.89n-0.16) inches. For panel-mounting see below.

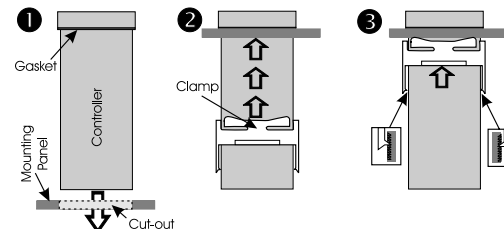
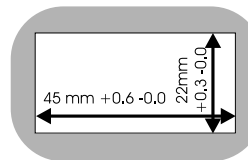

CAUTION: Do not remove the front panel gasket from the Controller, as this may cause inadequate clamping of the Controller to the mounting panel. Ensure that this gasket is not distorted and that the Controller is positioned squarely against the mounting panel. Apply pressure to the front panel bezel only.

Rear Terminals

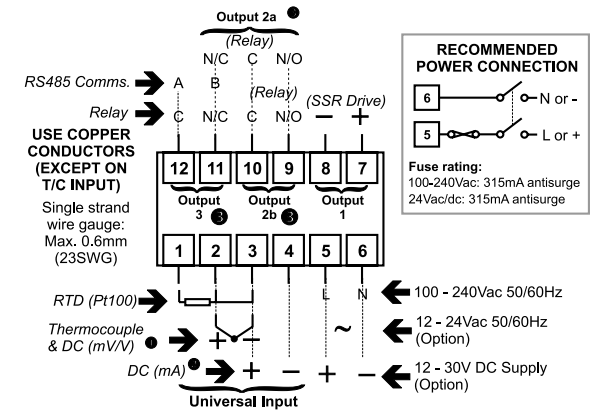

- The DC (mV) input may serve as DC (V) input using an external attenuator.
- If the DC (mA) input is used, Terminals 2 & 4 must be linked externally.
- Output 2a is available only if Output 3 (Comms or Alarm 2) is not fitted.

Output Usage

Output	Control Output	Alarm 1 Output	Alarm 2 Output	Serial Comms.
Output 1	*	*		
Output 2a	*	*		
Output 2b	*	*		
Output 3			*	*

CONFIGURATION MODE

Entry

Hold down the Scroll and Up keys simultaneously until the display starts to flash, then release those keys and press the Down key.

Configuration Mode Parameter Sequence

Parameters are selected and adjusted as described in NORMAL OPERATION.

Legend	Parameter	Adjustment Range	Default
SEnS	Sensor Select: Selects input sensor type, resolution and input units (°F or °C) by means of a code number.	See Sensor Selection Codes below.	100 - Thermocouple "J" (-200°C to 1200°C)
rLo	Input Range Minimum: Defines minimum value of input range.	Thermocouple/RTD: Range Minimum value for selected sensor (See Sensor Selection Codes below) to 100 LSDs less than current Input Range Maximum setting. DC: -1999 to 9999 with decimal point position according to Input Range Decimal Point setting	Thermocouple/RTD: Input Range Minimum. DC: 0
rHi	Input Range Maximum: Defines maximum value of input range.	Thermocouple/RTD: 100 LSDs greater than current Input Range Minimum setting to Range Maximum value for selected sensor (See Sensor Selection Codes below). DC: -1999 to 9999 with decimal point position according to Input Range Decimal Point setting	Thermocouple/RTD: Input Range Maximum. DC: 1000
rPnt	Input Range Decimal Point Position: For DC inputs only; determines decimal point position.	0 (xxxx), 1 (xxx.x) 2 (xx.xx) or 3 (x.xxx)	0 (xxxx)
OUtS	Output Selection: Links outputs to required functions by a 3-digit code (see Output Selection Code).	See Output Selection Code.	N/A
Addr	Communications Address: Defines unique communications address for Controller. Appears only if the Communications Option is configured and fitted.	1 to 128	1
BAUD	Communications Baud Rate: selects Baud rate for serial communications. Appears only if the Communications Option is configured and fitted.	12 1200 24 2400 48 4800 96 9600	4800
PAR	Communications Parity: defines parity for serial communications. Appears only if the Communications Option is configured and fitted.	odd Odd none None	Even

Legend	Parameter	Adjustment Range	Default
SPS	Single/Dual Setpoint Select: Selects single setpoint operation or dual setpoint operation.	Single Dual	Single setpoint operation
AL1	Alarm 1 Type	Process High, direct-acting Process Low, direct-acting Deviation, direct-acting Band, direct-acting Process High, reverse-acting Process Low, reverse-acting Deviation, reverse-acting Band, reverse-acting	Process High, direct-acting
AL2	Alarm 2 Type. <i>Appears only if Output 3 is configured and fitted.</i>	As for Alarm 1 Type.	Process Low, direct-acting
CNTRL	Control Select: defines control action and algorithm	PID, reverse-acting PID, direct-acting ON/OFF, reverse-acting ON/OFF, direct-acting	PID, reverse-acting
EASY	Tuning Select: Selects Manual Tuning or Hands-Off tuning (Easy Tune). <i>Appears only if PID control is selected (see above).</i>	Easy Tune Manual Tuning (with Pre-Tune)	Easy Tune

Sensor Selection Codes

Input Type	Code	Range Minimum	Range Maximum
Thermocouple			
Type J	100 (°C)	-200°C	1200°C
	101 (°F)	-32°F	2191°F
	110 (°C)	-128.0°C	537.0°C
	111 (°F)	-198.4°F	998.5°F
Type T	200 (°C)	-240°C	401°C
	201 (°F)	-400°F	753°F
	210 (°C)	-128.0°C	400.6°C
	211 (°F)	-198.4°F	753.0°F
Type K	300 (°C)	-240°C	1371°C
	301 (°F)	-400°F	2499°F
	310 (°C)	-128.0°C	536.7°C
	311 (°F)	-198.4°F	998.0°F
Type N	400 (°C)	0°C	1399°C
	401 (°F)	32°F	2550°F
Type B	500 (°C)	100°C	1824°C
	501 (°F)	211°F	3315°F
Type R	600 (°C)	0°C	1759°C
	601 (°F)	32°F	3198°F
Type S	700 (°C)	0°C	1770°C
	701 (°F)	32°F	3217°F
RTD			
PT100	800 (°C)	-199°C	802°C
	801 (°F)	-327°F	1475°F
	810 (°C)	-127.9°C	537.0°C
	811 (°F)	-198.3°F	998.5°F
DC Linear			
0 - 20mA	900	-1999	9999
4 - 20mA	1000	-1999	9999
0 - 50mV	2000	-1999	9999
10 - 50mV	3000	-1999	9999

Output Selection Code

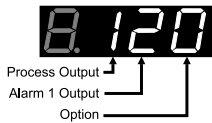

Process Output		Alarm 1 Output		Option	
Code	Meaning	Code	Meaning	Code	Meaning
0	Not fitted	0	Not fitted	0	Not fitted
1	Enables Output 2 Relay as control output (if fitted)	1	Enables Output 2 Relay (a or b) as Alarm 1 (if fitted)	1	Enables Second Relay output as Alarm 2 (if fitted)
2	Enables Output 1 SSR Drive as control output (if fitted)	2	Enables Output 1 SSR Drive as Alarm 1 (if fitted)	2	Enables Comms. Option (MODBUS) (if fitted)

Exit

Display any parameter name then hold down the Up and Down keys for three seconds.

NOTE: An automatic exit is made if there is no key activity for five minutes.

MODBUS COMMUNICATIONS

Functions Supported

The following MODBUS functions are supported, (JBUS names - where such an equivalence exists - in italics):

- Read Coil Status (*Read n Bits*) - **01/02**
- Read Holding Registers (*Read n Words*) - **03/04**
- Force Single Coil (*Write 1 Bit*) - **05**
- Preset Single Register (*Write 1 Word*) - **06**
- Loopback Diagnostic Test - **08**
- Preset Multiple Registers (*Write n Words*) - **16**

The instrument will identify itself in reply to a Read Holding Registers message which enquires the values of parameter numbers 121 and 122.

Bit Parameters		
Parameter	Number	Notes
Reserved	1 - 3	
Pre-Tune*	4	To enable Pre-Tune, write a non-zero value; to disable Pre-Tune, write zero. Enable Pre-Tune will fail if the process variable is within 5% of input span from the setpoint. This failure will not be signalled by communications.
Alarm 1 Status	5	Read Only
Alarm 2 Status	6	Read Only
Reserved	7 - 16	

Word Parameters		
Parameter	Number	Notes
Process Variable value	1	Read Only
Current Setpoint value	2	Read Only
Output Power	3	Read Only
Deviation	4	Read Only
Proportional Band	5	
Reset	6	
Rate	7	
Bias	8	
ON/OFF Differential	9	
Output Cycle Time	10	
Input Filter Time Constant	11	
Alarm 1 value	12	
Alarm 2 value	13	
Selected Setpoint (1 or 2)	14	
Setpoint 1 value	15	
Setpoint 2 value	16	
Process Variable Offset	17	
Range Decimal Point Position	18	
Manufacturer ID	121	Read Only - 231 (representing "W1")
Equipment ID	122	Read Only - number 2300

MESSAGES & ERROR INDICATIONS

Default Indication

This display (all decimal points ON) indicates that all Set Up parameters have been set to their default values (caused by a change to one or more of the critical Configuration Mode parameters). To clear this display, alter one of the Set Up Mode parameters.



Sensor Break Indication

This display indicates that a break has been detected in process variable input sensor or wiring. Alternatively, the Sensor Select parameter may be set incorrectly for the signal type applied.



Over-Range Indication

This display indicates that the input signal is greater than the Input Range Maximum. Alternatively, the Sensor Select parameter may be set incorrectly for the signal type applied.



Under-Range Indication

This display indicates that the input signal is less than the Input Range Minimum. Alternatively, the Sensor Select parameter may be set incorrectly for the signal type applied.



SPECIFICATION

UNIVERSAL INPUT

Input impedance: >1MΩ resistive except for DC mA (4.7Ω).
Isolation: Isolated from all outputs (except SSR) Drive at 240V AC.

OUTPUTS

Relay (Output 2 and Output 3)

Contact Type/Rating: Output 2a is Single Pole Double Throw (SPDT), Output 2b & Output 3 are Single Pole Single Throw (SPST); 2A resistive @ 120/240V AC. Isolated from all inputs / outputs >500,000 operations at rated voltage/current.

Lifetime:

SSR Drive/TTL (Output 1)

Drive Capability: 0 to 10V nominal into 500Ω minimum (20mA maximum).

Isolation: Not isolated from input.

OPERATING CONDITIONS FOR INDOOR USE

Ambient Temperature (Operating): 0°C to 55°C.

Ambient Temperature (Storage): -20°C to +80°C.

Relative Humidity: 20% to 95% non-condensing.

Supply Voltage: 100 - 240Vac 50/60Hz (standard) 7.5VA

12 - 24Vac (option) 7.5VA or 12 - 30Vdc (option) 5W

ENVIRONMENTAL

Approvals: CE, UL, ULC.

EMC: Certified to EN61326

Safety Considerations: Complies with EN61010-1

Front Panel Sealing: To IP66.

PHYSICAL

Dimensions: Depth (behind panel) - 100mm
Width (front panel) - 49mm
Height (front panel) - 25mm

Weight: 0.21kg maximum