

High Performance IEC Inlet Filter

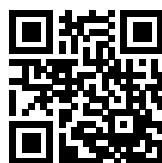

- Rated currents up to 20 A
- Optional medical versions (B type)
- Rear mounting
- Excellent attenuation in the lower frequency range



Performance indicators

Attenuation performance



Rated current [A]



Approvals & Compliances



The FN 9246 IEC inlet filter combines an IEC inlet and mains filter with excellent filter attenuation in a small form factor. Choosing the FN 9246 product line brings you the rapid availability of a standard filter associated with the necessary safety acceptances. Standard IEC connector filters are a practical solution helping you to pass EMI system approval in a short time. A wide selection on current ratings and low leakage versions for medical applications are designed to offer you the desired solution.

Features and Benefits

- Excellent conducted attenuation performance, based on chokes with high saturation resistance and excellent thermal behavior
- Rear mounting
- FN 9246 B versions comply with the requirements of 1MOP acc. to IEC/EN 60601-1 for creepage and clearance, leakage current and high potential testing
- Rated currents up to 20 A
- Custom-specific versions are available on request

Technical Specifications

Maximum continuous operating voltage	250 VAC, 50/60 Hz
Operating frequency	DC to 400 Hz
Rated currents	1 to 20 A @ 50°C
Approvals by rated current	1 to 10 A (Semko) 16 A (Semko) for 16 and 20 A types 1 to 20 A (UL, CSA)
High potential test voltage	P → N 1100 VDC for 2 sec (16 and 20 A types) P → PE 2000 VAC for 2 sec (standard types) P → PE 2500 VAC for 2 sec (B types) P → N 1100 VAC for 2 sec (1 to 10 A types)
Protection category	IP 40 according to IEC 60529
Temperature range (operation and storage)	-25°C to +85°C (25/85/21)
Design corresponding to	UL 1283, CSA 22.2 No. 8 1986, IEC/EN 60939
Flammability corresponding to	UL 94 V-2 or better
MTBF @ 40°C/230 V (Mil-HB-217F)	1,600,000 hours

Typical Applications

- Electrical and electronic equipment
- Small to medium-sized machines and household equipment
- Single-phase power supplies, switch-mode power supplies
- Test and measurement equipment
- Building automation
- Medical equipment
- Lighting application

Typical electrical schematic

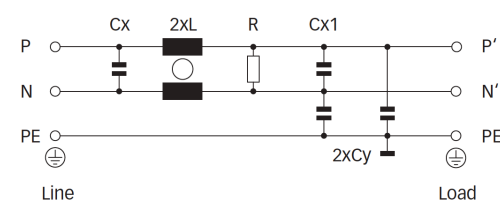

Filter Selection Table

Filter	Rated current @ 40°C (25°C) [A]	Leakage current* @ 250 VAC/50 Hz (@ 120 VAC/60 Hz) [mA]	Inductance L [mH]	Capacitance		Resistance R [kΩ]	Output connections 	Weight [g]
				Cx [μF]	Cy [nF]			
FN 9246-1-06	1 (1.2)	0.31 (0.18)	50	1.22	2.2	470	-06	140
FN 9246-3-06	3 (3.5)	0.31 (0.18)	14	1.22	2.2	470	-06	140
FN 9246-6-06	6 (7.2)	0.31 (0.18)	7	1.22	2.2	470	-06	140
FN 9246-10-06	10 (12)	0.31 (0.18)	3	1.22	2.2	470	-06	140
FN 9246-12-06	12 (14)	0.31 (0.18)	1.85	1.22	2.2	470	-06	140
FN 9246-15-06	15 (18)	0.31 (0.18)	0.89	1.22	2.2	470	-06	140
FN 9246-16-06	16 (18.5)	0.66 (0.38)	2.5	1.22	4.7	470	-06	275
FN 9246-20-06	20 (23)	0.66 (0.38)	1.5	1.22	4.7	470	-06	275
FN 9246 B-1-06	1 (1.2)	0.00	50	1.22		470	-06	140
FN 9246 B-3-06	3 (3.5)	0.00	14	1.22		470	-06	140
FN 9246 B-6-06	6 (7.2)	0.00	7	1.22		470	-06	140
FN 9246 B-10-06	10 (11.6)	0.00	3	1.22		470	-06	140
FN 9246 B-12-06	12 (14)	0.00	1.85	1.22		470	-06	140
FN 9246 B-15-06	15 (18)	0.00	0.89	1.22		470	-06	140
FN 9246 B-16-06	16 (18.5)	0.00	2.5	1.22		470	-06	275
FN 9246 B-20-06	20 (23)	0.00	1.5	1.22		470	-06	275

* Maximum leakage under normal operating conditions (acc. to IEC60939-3). Note: if the neutral line is interrupted, worst case leakage could reach twice this level.

Typical Filter Attenuation

Per CISPR 17; A=50 Ω/50 Ω sym; B=50 Ω/50 Ω asym; C=0.1 Ω/100 Ω sym; D=100 Ω/0.1 Ω sym

1 and 3 A types

6 to 10 A types

12 and 15 A types

16 and 20 A types

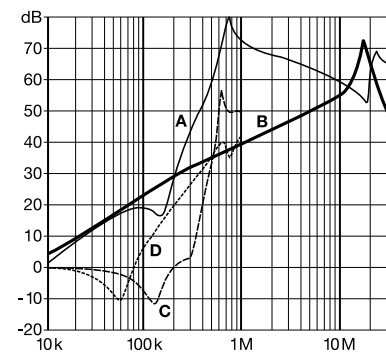
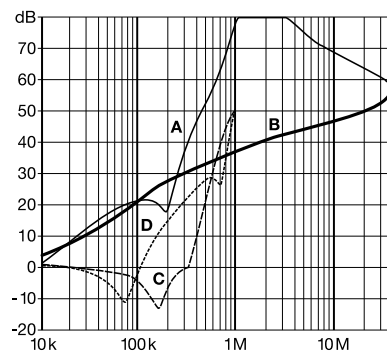
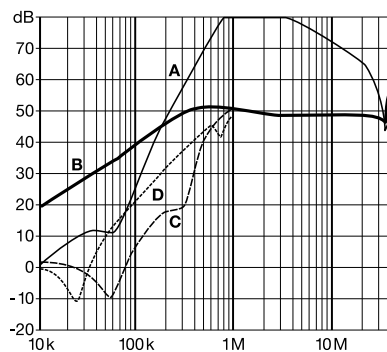
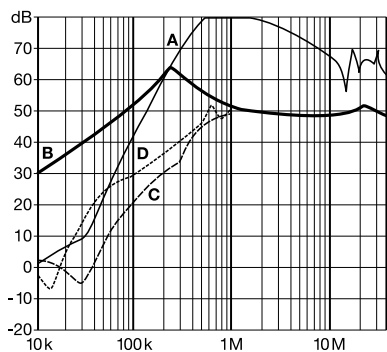

Product selector

FN 9246x-yy-..

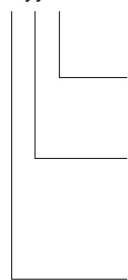

- 06: Faston 6.3 x 0.8mm (spade/soldering)
- 1 to 20: Rated current
Standard IEC inlet type C14 (1 to 15A types), C20 (16 and 20A types)
- Blank: Standard version
- B: Medical version (with bleed resistor and without Y2-capacitor)

For example: FN 9246-6-06, FN 9246 B-10-06

Mechanical Data

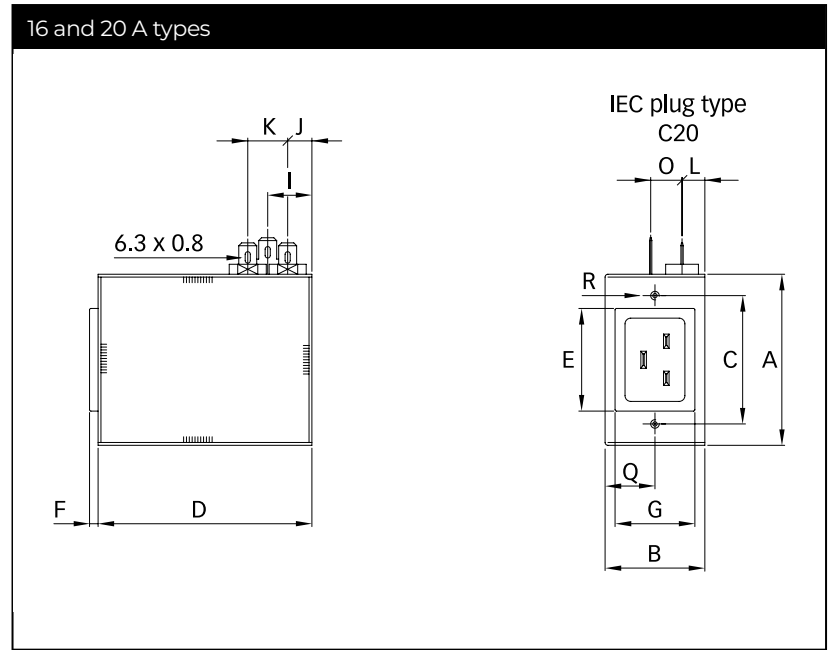
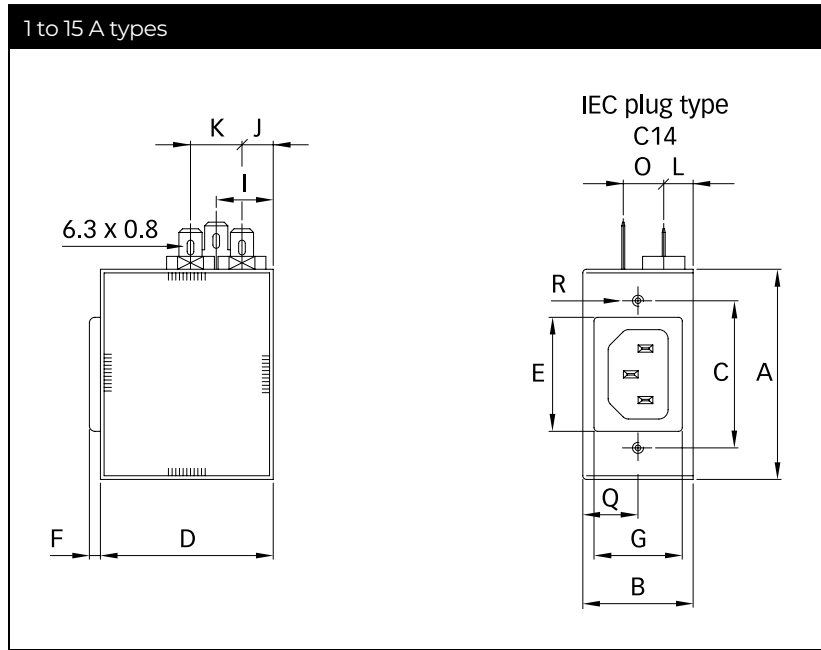

Panel cut out

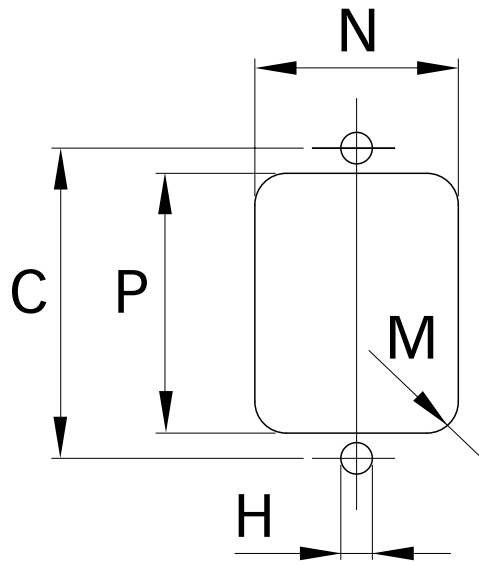

	1 A	3 A	6 A	10 A	12 A	15 A	16 A	20 A
A	57.15	57.15	57.15	57.15	57.15	57.15	60	60
B	30	30	30	30	30	30	35	35
C	40	40	40	40	40	40	45	45
D	47	47	47	47	47	47	75	75
E	31	31	31	31	31	31	36	36
F	3	3	3	3	3	3	3	3
G	24	24	24	24	24	24	28	28
H	Ø3.5	Ø3.5	Ø3.5	Ø3.5	Ø3.5	Ø3.5	Ø3.5	Ø3.5
I	15.5	15.5	15.5	15.5	15.5	15.5	15.5	15.5
J	8.5	8.5	8.5	8.5	8.5	8.5	8.5	8.5
K	14	14	14	14	14	14	14	14
L	8	8	8	8	8	8	8	8
M	R ≤ 1.5	R ≤ 1.5	R ≤ 1.5	R ≤ 1.5	R ≤ 1.5	R ≤ 1.5	R ≤ 1.5	R ≤ 1.5
N	25	25	25	25	25	25	29	29
O	11	11	11	11	11	11	11	11
P	32	32	32	32	32	32	37	37
Q	15	15	15	15	15	15	17.5	17.5
R				M3 x 10 max.				

All dimensions in mm; 1 inch = 25.4 mm
 Tolerances according: ISO 2768-m/EN 22768-m

Accessories

Power Cord with angled Locking System C13



- Protects appliances that are vulnerable to vibration
- Connector cannot be accidentally pulled or vibrated out of the inlet
- Space availability/constraints
- Different angles for ease of access
- Space saving
- Release locking mechanism
- Prevents accidental disconnection

[Technical Data Sheet >](#)

IL 13P IEC C13 Rewireable Angled Connectors with Locking System



- Protects appliances that are vulnerable to vibration
- Connector cannot be accidentally pulled or vibrated out of the inlet
- Space availability/constraints
- Different angles for ease of access
- Space saving
- Release locking mechanism
- Prevents accidental disconnection

[Technical Data Sheet >](#)

IL 13P IEC C13 Rewireable Connectors with Locking System

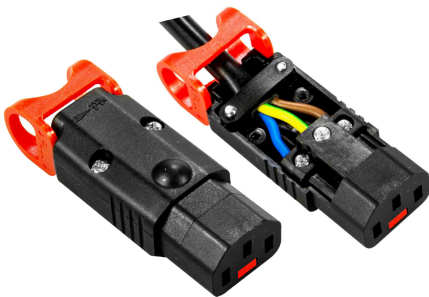

The locking system has a tensile force of typical 300N. It is recommended to use it with flange mount filters. For details refer to our Application Note "Using IEC Lock Power Cords with IEC Inlets and Filters".

Schaffner power connector with IEC lock guard against accidental disconnection of all electrical appliances with an IEC inlet. No exchange or modification of the IEC inlet or IEC inlet filter system is needed. Easy retrofit for all electronic equipments and devices

[Technical Data Sheet >](#)

Headquarters, Global Innovation and Development

Switzerland

Schaffner Holding AG

Industrie Nord
 Nordstrasse 11e
 4542
 Luterbach
 +41 32 681 66 26
info@schaffner.com

Sales and Application Centers

China

Schaffner EMC Ltd. Shanghai

T20-3 C, No 565 Chuangye Road, Pudong district
 201201
 Shanghai
 +86 2138139500
cschina@schaffner.com

Finland

Schaffner Oy

Sauvonrinne 19 H
 8500
 Lohja
 +358 50 468 7284
finlandsales@schaffner.com

France

Schaffner EMC S.A.S.

16-20 Rue Louis Rameau
 95875
 Bezons
 +33 1 34 34 30 60
francesales@schaffner.com

Germany

Schaffner Deutschland GmbH

Schoemperlenstrasse 12B
 76185
 Karlsruhe
 +49 721 56910
germanysales@schaffner.com

India

Schaffner India Pvt. Ltd

Regus World Trade Centre
 WTC, 22nd Floor Unit No 2238, Brigade Gateway Campus, 26/1, Dr. Rajkumar Road Malleshwaram (W)
 560055
 Bangalore
 +91 8067935355
indiasales@schaffner.com

Italy

Schaffner EMC S.r.l.

Via Ticino, 30
 20900
 Monza (MB)
 +39 039 21 41 070
italysales@schaffner.com

Japan

Schaffner EMC K.K.

ISM Sangenjaya 7F
 1-32-12 Kamiuma, Setagaya-ku
 154-0011
 Tokyo
 +81 3 5712 3650
japansales@schaffner.com

Singapore

Schaffner EMC Pte Ltd.

Blk 3015A Ubi Road 1, #05-09, Kampong Ubi Industrial Estate
 408705
 Singapore
 +65 63773283
singaporesales@schaffner.com

Spain

Schaffner EMC España

Calle Caléndula 93, Miniparc III, Edificio E El Soto de Moraleja, Alcobendas
 28109
 Madrid
 +34 917 912 900
spainsales@schaffner.com

Sweden

Schaffner EMC AB

Östermalmstrorg 1
 114 42
 Stockholm
 +46 8 5050 2425
swedensales@schaffner.com

Switzerland

Schaffner EMV AG

Industrie Nord
 Nordstrasse 11e
 4542
 Luterbach
 +41 32 681 66 26
switzerlandsales@schaffner.com

Taiwan

Schaffner EMV Ltd.

U-Town
 20 Floor-2, No 97, Section 1, XinTai 5th Road, XiZhi District
 22175
 New Taipei City
 +886 226975500
taiwansales@schaffner.com

Thailand

Schaffner EMC Co. Ltd.

Sathorn Square Tower
 Room 3780, 37FL, 98 North-Sathorn Rd, Silom, Bangrak
 10500
 Bangkok
 +66 621056397
thailandsales@schaffner.com

United Kingdom

Schaffner Ltd.

1, Oakmede Place
 Terrace Road
 RG42 4JF
 Binfield
 +44 118 9770070
uksales@schaffner.com

United States

Schaffner EMC Inc.

52 Mayfield Avenue
 Edison, New Jersey
 +1 732 225 9533
usasales@schaffner.com

To find your local partner within Schaffner's global network schaffner.com

© 2022 Schaffner Group

The content of this document has been carefully checked and understood. However, neither Schaffner nor its subsidiaries assume any liability whatsoever for any errors or inaccuracies of this document and the consequences thereof. Published specifications are subject to change without notice. Product suitability for any area of application must ultimately be determined by the customer. In all cases, products must never be operated outside their published specifications. Schaffner does not guarantee the availability of all published products. This disclaimer shall be governed by substantive Swiss law and resulting disputes shall be settled by the courts at the place of business of Schaffner Holding AG. Latest publications and a complete disclaimer can be downloaded from the Schaffner website. All trademarks recognized.

Mouser Electronics

Authorized Distributor

Click to View Pricing, Inventory, Delivery & Lifecycle Information:

Schaffner:

[FN9246B-15-06](#) [FN9246-1-06](#) [FN9246-3-06](#) [FN9246-6-06](#) [FN9246-10-06](#) [FN9246-12-06](#) [FN9246-15-06](#) [FN9246-16-06](#) [FN9246-20-06](#) [FN9246A-20-06](#) [FN9246B-6-06](#) [FN9246B-12-06](#) [FN9246B-20-06](#)