

FEATURES

Fast 12-Bit ADC with 220 kSPS Throughput Rate
8-Lead SOIC
Single 5 V Supply Operation
High Speed, Flexible, Serial Interface that
Allows Interfacing to 3 V Processors
On-Chip Track/Hold Amplifier
Selection of Input Ranges
 ± 10 V for AD7898-10
 ± 2.5 V for AD7898-3
High Input Impedance
Low Power: 22.5 mW Max

FUNCTIONAL BLOCK DIAGRAM

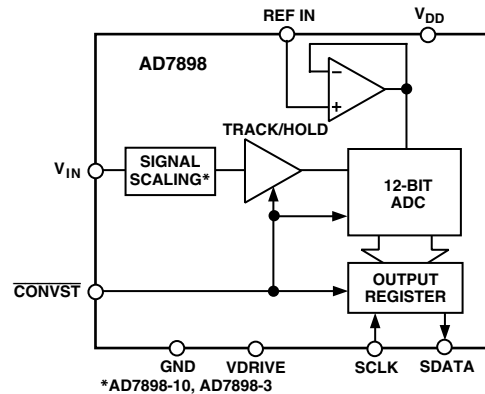

GENERAL DESCRIPTION

The AD7898 is a fast 12-bit ADC that operates from a single 5 V supply and is housed in a small 8-lead SOIC package. The part contains a successive approximation A/D converter, an on-chip track/hold amplifier, an on-chip clock, and a high speed serial interface.

The AD7898 offers two modes of operation. In Mode 0, conversion is initiated by the $\overline{\text{CONVST}}$ input and the conversion process is controlled by an internal clock oscillator. In this mode, the serial interface consists of three wires and the AD7898 is capable of throughput rates up to 220 kSPS. In Mode 1, the conversion process is controlled by an externally applied SCLK with data being accessed from the part during conversion. In this mode, the serial interface consists of three wires and the AD7898 is capable of throughput rates up to 220 kSPS.

In addition to the traditional dc accuracy specifications, such as linearity and full-scale and offset errors, the AD7898 is specified for dynamic performance parameters, including harmonic distortion and signal-to-noise ratio.

The part accepts an analog input range of ± 10 V (AD7898-10) and ± 2.5 V (AD7898-3), and operates from a single 5 V supply, consuming only 22.5 mW max.

The part is available in an 8-lead Standard Small Outline Package (SOIC).

*Protected by U.S. Patent No. 6,681,332

REV. A

Information furnished by Analog Devices is believed to be accurate and reliable. However, no responsibility is assumed by Analog Devices for its use, nor for any infringements of patents or other rights of third parties that may result from its use. No license is granted by implication or otherwise under any patent or patent rights of Analog Devices. Trademarks and registered trademarks are the property of their respective owners.

PRODUCT HIGHLIGHTS

- Fast, 12-Bit ADC in 8-Lead Package**
The AD7898 contains a 220 kSPS ADC, a track/hold amplifier, control logic, and a high speed serial interface, all in an 8-lead package. This offers considerable space saving over alternative solutions.
- Low Power, Single-Supply Operation**
The AD7898 operates from a single 5 V supply and consumes only 22.5 mW. The V_{DRIVE} function allows the serial interface to connect directly to either 3 V or 5 V processor systems independent of V_{DD} .
- Flexible, High Speed Serial Interface**
The part provides a flexible, high speed serial interface that has two distinct modes of operation. Mode 0 provides a three-wire interface with data being accessed from the AD7898 when conversion is complete. Mode 1 offers a three-wire interface with data being accessed during conversion.
- Power-Down Mode**
The AD7898 offers a proprietary power-down capability when operated in Mode 1, making the part ideal for portable or hand-held applications.

AD7898—SPECIFICATIONS¹ ($V_{DD} = 4.75\text{ V to }5.25\text{ V}$, $V_{DRIVE} = 2.7\text{ V to }5.25\text{ V}$; REF IN = 2.5 V. Specifications apply to both Mode 0 and Mode 1 operations; $T_A = T_{MIN}$ to T_{MAX} , unless otherwise noted.)

Parameter	A Version ¹	Unit	Test Conditions/Comments
DYNAMIC PERFORMANCE			
Signal to (Noise + Distortion) Ratio ² T_{MIN} to T_{MAX}	71	dB min	$f_{IN} = 30\text{ kHz Sine Wave}$
Total Harmonic Distortion (THD) ²	-78	dB max	$f_{IN} = 30\text{ kHz Sine Wave}$
Peak Harmonic or Spurious Noise ²	-89	dB typ	$f_{IN} = 30\text{ kHz Sine Wave}$
Intermodulation Distortion (IMD) ² 2nd Order Terms	-88	dB typ	$f_a = 29.1\text{ kHz}$, $f_b = 29.9\text{ kHz}$
3rd Order Terms	-88	dB typ	
Aperture Delay	20	ns typ	
Aperture Jitter	75	ps typ	
Full Power Bandwidth-AD7898-10	3.6	MHz typ	@ 3 dB
Full Power Bandwidth-AD7898-3	4.7	MHz typ	@ 3 dB
Full Power Bandwidth-AD7898-10	2.15	MHz typ	@ 1 dB
Full Power Bandwidth-AD7898-3	2.4	MHz typ	@ 1 dB
DC ACCURACY			
Resolution	12	Bits	
Minimum Resolution for Which No Missing Codes are Guaranteed	12	Bits	
Relative Accuracy ²	± 1	LSB max	
Differential Nonlinearity ²	± 0.9	LSB max	
Positive Full-Scale Error ²	± 3	LSB max	
Negative Full-Scale Error ²	± 3	LSB max	
Bipolar Zero Error	± 4	LSB max	
ANALOG INPUT			
AD7898-10			
Input Voltage Range	± 10	Volts	
Input Resistance	24	k Ω min	
AD7898-3			
Input Voltage Range	± 2.5	Volts	
Input Resistance	5	k Ω min	
REFERENCE INPUT			
REF IN Input Voltage Range	2.375/2.625	V min/V max	2.5 V \pm 5%
Input Current	1	μ A max	
Input Capacitance ^{2, 3}	10	pF max	
LOGIC INPUTS			
Input High Voltage, V_{INH}	$V_{DRIVE} \times 0.7$	V min	
Input Low Voltage, V_{INL} ⁴	$V_{DRIVE} \times 0.3$	V max	
Input Current, I_{IN}	± 1	μ A max	Typically 10 nA, $V_{IN} = 0\text{ V}$ or V_{DRIVE}
Input Capacitance, C_{IN} ^{2, 3}	10	pF max	
LOGIC OUTPUTS			
Output High Voltage, V_{OH}	$V_{DRIVE} - 0.4$	V min	$I_{SOURCE} = 200\ \mu\text{A}$; $V_{DRIVE} = 2.7\text{ V to }5.25\text{ V}$
Output Low Voltage, V_{OL}	0.4	V max	$I_{SINK} = 200\ \mu\text{A}$
Floating-State Leakage Current	± 10	μ A max	
Floating-State Output Capacitance ^{2, 3}	10	pF max	
Output Coding	Twos Complement		
CONVERSION RATE			
Mode 0 Operation	220	kSPS max	With $V_{DRIVE} = 5\text{ V} \pm 5\%$
Mode 1 Operation	215	kSPS max	With $V_{DRIVE} = 2.7\text{ V to }3.6\text{ V}$
Mode 1 Operation	220	kSPS max	
POWER REQUIREMENTS			
V_{DD}	4.75 to 5.25	V min to V max	For Specified Performance
V_{DRIVE}	2.7 to 5.25	V min to V max	For Specified Performance
I_{DD} Static	4.25	mA max	Digital Inputs @ V_{DRIVE}
I_{DD} Operational	4.5	mA max	Digital Inputs @ V_{DRIVE}
Power Dissipation	22.5	mW max	
POWER-DOWN MODE			
I_{DD} @ 25°C	5	μ A max	Digital Inputs @ GND, $V_{DD} = 5\text{ V} \pm 5\%$
T_{MIN} to T_{MAX}	20	μ A max	Digital Inputs @ GND, $V_{DD} = 5\text{ V} \pm 5\%$
Power Dissipation @ 25°C (Operational)	25	μ W max	$V_{DD} = 5\text{ V}$

NOTES

¹Temperature ranges are as follows: A Version: -40°C to +85°C.

²See Terminology.

³Sample tested @ 25°C to ensure compliance.

⁴Operational with $V_{DRIVE} = 2.35\text{ V}$, with Input Low Voltage, $V_{INL} = 0.4\text{ V}$

Specifications subject to change without notice.

TIMING SPECIFICATIONS¹ ($V_{DD} = 4.75 \text{ V to } 5.25 \text{ V}$; $V_{DRIVE} = 2.7 \text{ V to } 5.25 \text{ V}$; $REF \text{ IN} = 2.5 \text{ V}$; $T_A = T_{MIN} \text{ to } T_{MAX}$, unless otherwise noted.)

Parameter	Limit at T_{MIN} , T_{MAX}	Unit	Description
Mode 0 Operation			
t_1	40	ns min	CONVST Pulse Width
t_2	26 ²	ns min	SCLK High Pulse Width, $V_{DRIVE} = 5 \text{ V} \pm 5\%$
t_3	26 ²	ns min	SCLK Low Pulse Width, $V_{DRIVE} = 5 \text{ V} \pm 5\%$
	30 ²	ns min	SCLK High Pulse Width $V_{DRIVE} = 2.7 \text{ V to } 3.6 \text{ V}$
	30 ²	ns min	SCLK Low Pulse Width $V_{DRIVE} = 2.7 \text{ V to } 3.6 \text{ V}$
t_4	60 ³	ns max	Data Access Time after Falling Edge of SCLK, $V_{DRIVE} = 5 \text{ V} \pm 5\%$
t_4	70 ³	ns max	Data Access Time after Falling Edge of SCLK, $V_{DRIVE} = 2.7 \text{ V to } 3.6 \text{ V}$
t_5	20	ns min	Data Hold Time after Falling Edge of SCLK
t_6	50 ⁴	ns max	Bus Relinquish Time after Falling Edge of SCLK
$t_{CONVERT}$	3.3	μs	
Mode 1 Operation			
f_{SCLK} ⁵	1	kHz min	
	3.7	MHz max	
$t_{CONVERT}$	$16 \times t_{SCLK}$		$t_{SCLK} = 1/f_{SCLK}$
	4.33	μs max	$f_{SCLK} = 3.7 \text{ MHz}$
t_{QUIET}	100	ns min	Minimum Quiet Time Required between Conversions
t_2	70	ns min	\overline{CS} to SCLK Setup Time
t_3 ³	40	ns max	Delay from \overline{CS} Until SDATA Three-State Disabled
t_4 ³	80	ns max	Data Access Time after SCLK Falling Edge
t_5	108	ns min	SCLK High Pulse Width
t_6	108	ns min	SCLK Low Pulse Width
t_7	60	ns min	SCLK to Data Valid Hold Time
t_8 ⁴	20	ns min	SCLK Falling Edge to SDATA High Impedance
	60	ns max	SCLK Falling Edge to SDATA High Impedance
$t_{POWER-UP}$	4.33	μs max	Power-Up Time from Power-Down Mode

NOTES

¹Sample tested at 25°C to ensure compliance. All input signals are specified with $t_r = t_f = 5 \text{ ns}$ (10% to 90% of V_{DD}) and timed from a voltage level of 1.6 V.

²The SCLK maximum frequency is 15 MHz for Mode 0 operation for 220 kSPS throughput with $V_{DRIVE} = 5 \text{ V} \pm 5\%$, SCLK = 13 MHz with $V_{DRIVE} = 2.7 \text{ V to } 3.6 \text{ V}$. The mark/space ratio for SCLK is specified for at least 40% high time (with corresponding 60% low time) or 40% low time (with corresponding 60% high time). As the SCLK frequency is reduced, the mark/space ratio may vary, provided limits are not exceeded. Care must be taken when interfacing to account for the data access time, t_4 , and the set-up time required for the users processor. These two times will determine the maximum SCLK frequency that the user's system can operate with. See Serial Interface section.

³Measured with the load circuit of Figure 1 and defined as the time required for the output to cross 0.8 V or 2.0 V.

⁴ t_6 and t_8 are derived from the measured time taken by the data outputs to change 0.5 V when loaded with the circuit of Figure 1. The measured number is then extrapolated back to remove the effects of charging or discharging the 50 pF capacitor. This means that the time, t_6 and t_8 , quoted in the timing characteristics is the true bus relinquish time of the part and is independent of the bus loading.

⁵Mark/Space ratio for the SCLK input is 40/60 to 60/40.

Specifications subject to change without notice.

AD7898

ABSOLUTE MAXIMUM RATINGS*

($T_A = 25^\circ\text{C}$ unless otherwise noted)

V_{DD} to GND	−0.3 V to +7 V
Analog Input Voltage to GND	
AD7898-10	±17 V
AD7898-3	±10 V
Reference Input Voltage to GND	−0.3 V to $V_{DD} + 0.3$ V
Digital Input Voltage to GND	−0.3 V to $V_{DD} + 0.3$ V
Digital Output Voltage to GND	−0.3 V to $V_{DD} + 0.3$ V
Operating Temperature Range	
Commercial (A, B Versions)	−40°C to +85°C
Storage Temperature Range	−65°C to +150°C
Junction Temperature	150°C
SOIC Package, Power Dissipation	450 mW
θ_{JA} Thermal Impedance	170°C/W
Lead Temperature, Soldering	
Vapor Phase (60 sec)	215°C
Infrared (15 sec)	220°C
ESD	
AD7898-10	2.5 kV
AD7898-3	4 kV

*Stresses above those listed under Absolute Maximum Ratings may cause permanent damage to the device. This is a stress rating; functional operation of the device at these or any other conditions above those listed in the operational sections of this specification is not implied. Exposure to absolute maximum rating conditions for extended periods may affect device reliability.

PIN CONFIGURATION

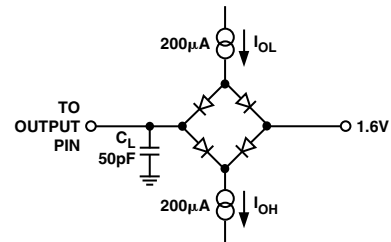
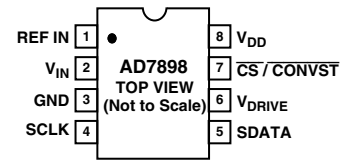

Figure 1. Load Circuit for Digital Output Timing Specifications

ORDERING GUIDE

Model	Temperature Range	Linearity Error ¹	SNR	Package Option ²
AD7898AR-10	−40°C to +85°C	±1 LSB	71 dB	R-8
AD7898AR-10REEL	−40°C to +85°C	±1 LSB	71 dB	R-8
AD7898AR-10REEL7	−40°C to +85°C	±1 LSB	71 dB	R-8
AD7898ARZ-10 ³	−40°C to +85°C	±1 LSB	71 dB	R-8
AD7898ARZ-10REEL ³	−40°C to +85°C	±1 LSB	71 dB	R-8
AD7898ARZ-10REEL7 ³	−40°C to +85°C	±1 LSB	71 dB	R-8
AD7898AR-3	−40°C to +85°C	±1 LSB	71 dB	R-8
AD7898AR-3REEL	−40°C to +85°C	±1 LSB	71 dB	R-8
AD7898AR-3REEL7	−40°C to +85°C	±1 LSB	71 dB	R-8
EVAL-AD7898CB				
EVAL-CONTROL BRD ⁴				

NOTES

¹Linearity Error refers to integral linearity error.

²R = SOIC.

³Z = Pb-Free part.

⁴This board is a complete unit allowing a PC to control and communicate with all Analog Devices evaluation boards ending in the CB designators.

CAUTION

ESD (electrostatic discharge) sensitive device. Electrostatic charges as high as 4000 V readily accumulate on the human body and test equipment and can discharge without detection. Although the AD7898 features proprietary ESD protection circuitry, permanent damage may occur on devices subjected to high-energy electrostatic discharges. Therefore, proper ESD precautions are recommended to avoid performance degradation or loss of functionality.



PIN FUNCTION DESCRIPTIONS

Pin No.	Pin Mnemonic	Function
1	REF IN	Voltage Reference Input. An external reference source should be connected to this pin to provide the reference voltage for the AD7898's conversion process. The REF IN input is buffered on-chip. The nominal reference voltage for correct operation of the AD7898 is $2.5\text{ V} \pm 5\%$. A $0.1\text{ }\mu\text{F}$ capacitor should be placed on the REF IN pin.
2	V_{IN}	Analog Input Channel. The analog input range is $\pm 10\text{ V}$ (AD7898-10) and $\pm 2.5\text{ V}$ (AD7898-3).
3	GND	Analog Ground. Ground reference for track/hold, comparator, digital circuitry, and DAC.
4	SCLK	Serial Clock Input. An external serial clock is applied to this input to obtain serial data from the AD7898. When in Mode 0 operation, a new serial data bit is clocked out on the falling edge of this serial clock. In Mode 0, data is guaranteed valid for 20 ns after this falling edge so that data can be accepted on the falling edge when a fast serial clock is used. The serial clock input should be taken low at the end of the serial data transmission. When in Mode 1 operation, SCLK also provides the serial clock for accessing data from the part as in Mode 0, but this clock input is also used as the clock source for the AD7898's conversion process when in Mode 1.
5	SDATA	Serial Data Output. Serial data from the AD7898 is provided at this output. The serial data is clocked out by the falling edge of SCLK, but the data can also be read on the falling edge of SCLK. This is possible because data bit N is valid for a specified time after the falling edge of SCLK (data hold time). Sixteen bits of serial data are provided with four leading zeros followed by the 12 bits of conversion data, which is provided MSB first. On the 16th falling edge of SCLK, the SDATA line is held for the data hold time and then is disabled (three-stated). Output data coding is two's complement for the AD7898.
6	V_{DRIVE}	Logic Power Supply Input. The voltage supplied at this pin determines at what voltage the serial interface of the AD7898 will operate.
7	$\overline{\text{CS/CONVST}}$	Chip Select/Convert Start. This pin is $\overline{\text{CONVST}}$, an edge-triggered logic input when in Mode 0 operation. On the falling edge of this input, the track/hold goes into its hold mode, and conversion is initiated. When in Mode 1 operation, this pin is Chip Select, an active low logic input. This input provides the dual function of initiating conversions on the AD7898 and also frames the serial data transfer.
8	V_{DD}	Power Supply Input, $5\text{ V} \pm 5\%$.

AD7898

TERMINOLOGY

Signal to (Noise + Distortion) Ratio

This is the measured ratio of signal to (noise + distortion) at the output of the A/D converter. The signal is the rms amplitude of the fundamental. Noise is the rms sum of all nonfundamental signals up to half the sampling frequency ($f_s/2$), excluding dc. The ratio is dependent upon the number of quantization levels in the digitization process; the more levels, the smaller the quantization noise. The theoretical signal to (noise + distortion) ratio for an ideal N-bit converter with a sine wave input is given by:

$$\text{Signal to (Noise + Distortion)} = (6.02 N + 1.76) \text{ dB}$$

Thus for a 12-bit converter, this is 74 dB.

Total Harmonic Distortion

Total harmonic distortion (THD) is the ratio of the rms sum of harmonics to the fundamental. For the AD7898, it is defined as:

$$\text{THD (dB)} = 20 \log \frac{\sqrt{V_2^2 + V_3^2 + V_4^2 + V_5^2 + V_6^2}}{V_1}$$

where V_1 is the rms amplitude of the fundamental, and V_2 , V_3 , V_4 , V_5 , and V_6 are the rms amplitudes of the second through the sixth harmonics.

Peak Harmonic or Spurious Noise

Peak harmonic or spurious noise is defined as the ratio of the rms value of the next largest component in the ADC output spectrum (up to $f_s/2$ and excluding dc) to the rms value of the fundamental. Normally, the value of this specification is determined by the largest harmonic in the spectrum, but for parts where the harmonics are buried in the noise floor, it will be a noise peak.

Intermodulation Distortion

With inputs consisting of sine waves at two frequencies, f_a and f_b , any active device with nonlinearities will create distortion products at sum and difference frequencies of $m f_a \pm n f_b$ where $m, n = 0, 1, 2, 3$, etc. Intermodulation terms are those for which neither m nor n are equal to zero. For example, the second order terms include $(f_a + f_b)$ and $(f_a - f_b)$, while the third order terms include $(2 f_a + f_b)$, $(2 f_a - f_b)$, $(f_a + 2 f_b)$ and $(f_a - 2 f_b)$.

The AD7898 is tested using the CCIF standard where two input frequencies are used. In this case, the second and third order terms are of different significance. The second order terms are usually distanced in frequency from the original sine waves, while the third order terms are usually at a frequency close to the input frequencies. As a result, the second and third order terms are specified separately. The calculation of the intermodulation distortion is as per the THD specification where it is the ratio of the rms sum of the individual distortion products to the rms amplitude of the fundamental expressed in dBs.

Relative Accuracy

Relative accuracy or endpoint nonlinearity is the maximum deviation from a straight line passing through the endpoints of the ADC transfer function.

Differential Nonlinearity

This is the difference between the measured and the ideal 1 LSB change between any two adjacent codes in the ADC.

Positive Full-Scale Error (AD7898-10)

This is the deviation of the last code transition (01 . . . 110 to 01 . . . 111) from the ideal ($4 \times V_{REF} - 3/2$ LSB) after the Bipolar Zero Error has been adjusted out.

Positive Full-Scale Error (AD7898-3)

This is the deviation of the last code transition (01 . . . 110 to 01 . . . 111) from the ideal ($V_{REF} - 3/2$ LSB) after the Bipolar Zero Error has been adjusted out.

Bipolar Zero Error (AD7898-10, AD7898-3)

This is the deviation of the midscale transition (all 0s to all 1s) from the ideal AGND $- 1/2$ LSB.

Negative Full-Scale Error (AD7898-10)

This is the deviation of the first code transition (10 . . . 000 to 10 . . . 001) from the ideal ($-4 \times V_{REF} + 1/2$ LSB) after Bipolar Zero Error has been adjusted out.

Negative Full-Scale Error (AD7898-3)

This is the deviation of the first code transition (10 . . . 000 to 10 . . . 001) from the ideal ($-V_{REF} + 1/2$ LSB) after Bipolar Zero Error has been adjusted out.

Track/Hold Acquisition Time

Track/Hold acquisition time is the time required for the output of the track/hold amplifier to reach its final value, within $\pm 1/2$ LSB, after the end of conversion (the point at which the track/hold returns to track mode). It also applies to situations where there is a step input change on the input voltage applied to the V_{IN} input of the AD7898. This means that the user must wait for the duration of the track/hold acquisition time after the end of conversion, or after a step input change to V_{IN} , before starting another conversion to ensure that the part operates to specification.

PSR (Power Supply Rejection)

Variations in power supply will affect the full-scale transition, but not the converter's linearity. Power Supply Rejection is the maximum change in full-scale transition point due to change in power-supply voltage from the nominal value.

Typical Performance Characteristics—AD7898

PERFORMANCE CURVES

TPC 1 shows a typical FFT plot for the AD7898 at 220 kSPS sampling rate with a 30 kHz input frequency while operating in Mode 0.

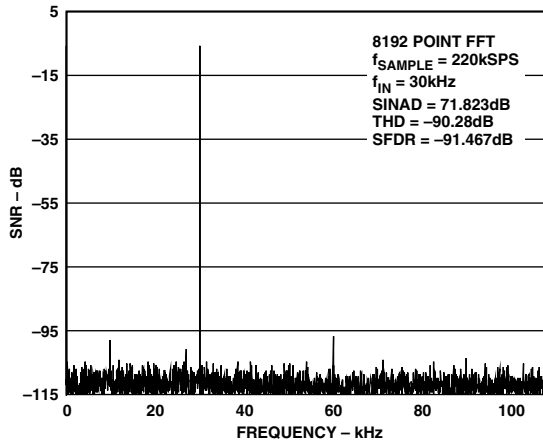

TPC 1. Mode 0 Dynamic Performance

TPC 2 shows a typical FFT plot for the AD7898 at 220 kSPS sampling rate with a 30 kHz input frequency while operating in Mode 1.

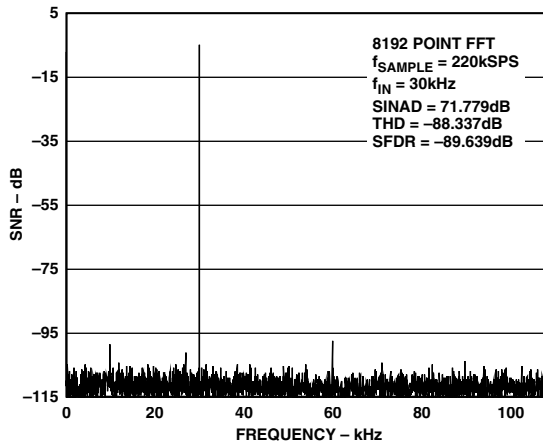

TPC 2. Mode 1 Dynamic Performance

TPC 3 shows the Power Supply Rejection Ratio versus supply frequency for the AD7898. The power supply rejection ratio is defined as the ratio of the power in the ADC output at full-scale frequency f , to the power of a 100 mV sine wave applied to the ADC V_{DD} supply of frequency f_s .

$$PSRR \text{ (dB)} = 10 \log (P_f/P_{f_s})$$

P_f = Power at frequency f in ADC output, P_{f_s} = power at frequency f_s coupled on to the ADC V_{DD} supply input. Here a 100 mV peak-to-peak sine wave is coupled onto the V_{DD} supply. 100 nF decoupling was used on the supply.

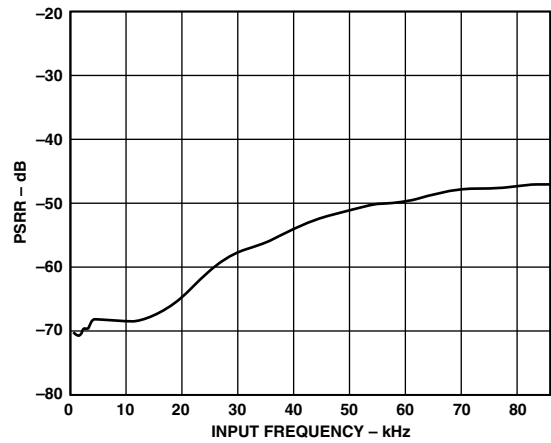

TPC 3. PSRR vs. Supply Ripple Frequency

TPC 4 shows a graph of effective number of bits versus input frequency while sampling at 220 kSPS.

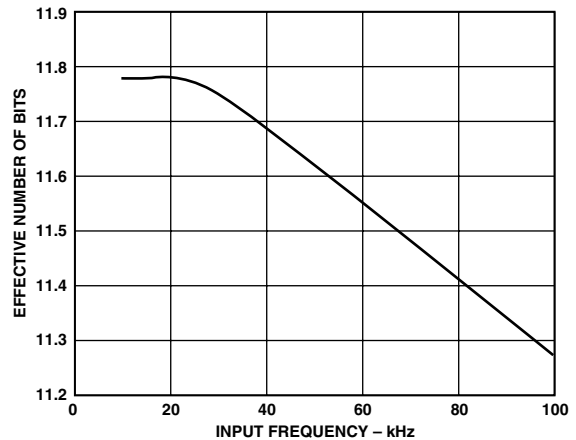

TPC 4. Effective Number of Bits vs. Input Frequency at 220 kSPS

The effective number of bits for a device can be calculated from its measured Signal to (Noise + Distortion) Ratio (see Terminology section). TPC 4 shows a typical plot of effective number of bits versus frequency for the AD7898 from dc to $f_{\text{SAMPLE}}/2$. The sampling frequency is 220 kSPS.

The formula for Signal to (Noise + Distortion) Ratio is related to the resolution or number of bits in the converter. Rewriting the formula, below, gives a measure of performance expressed in effective number of bits (N):

$$N = (SNR - 1.76)/6.02$$

where SNR is Signal to (Noise + Distortion) Ratio.

AD7898

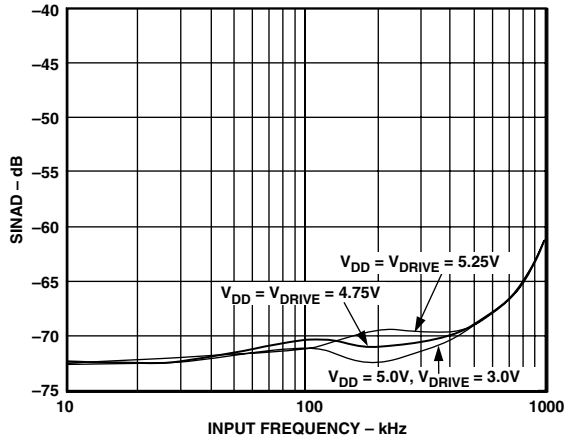

TPC 5. SINAD vs. Input Frequency at 220 kSPS

TPC 5 shows a graph of Signal to (Noise + Distortion) ratio versus Input Frequency for various supply voltages while sampling at 220 kSPS. The on-chip track-and-hold can accommodate frequencies up to 4.7 MHz for AD7898-3, and up to 3.6 MHz for AD7898-10, making the AD7898 ideal for subsampling applications.

Noise

In an A/D converter, noise exhibits itself as a code uncertainty in dc applications, and as the noise floor (in an FFT, for example) in ac applications. In a sampling A/D converter like the AD7898, all information about the analog input appears in the baseband, from dc to half the sampling frequency. The input bandwidth of the track/hold exceeds the Nyquist bandwidth and, therefore, an antialiasing filter should be used to remove unwanted signals above $f_s/2$ in the input signal in applications where such signals exist.

TPC 6 shows a histogram plot for 8192 conversions of a dc input using the AD7898. The analog input was set at the center of a code transition. It can be seen that almost all the codes appear in one output bin, indicating very good noise performance from the ADC.

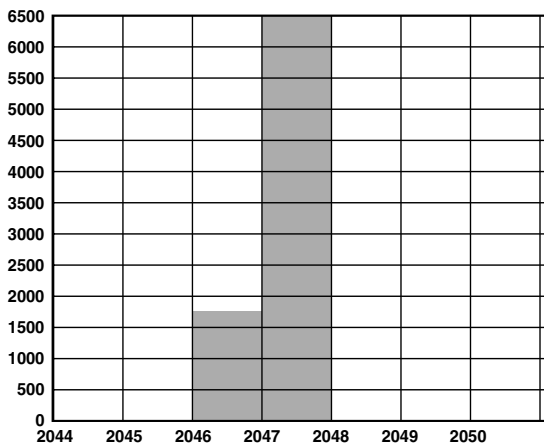

TPC 6. Histogram of 8192 Conversions of a DC Input

CONVERTER DETAILS

The AD7898 is a fast, 12-bit single supply A/D converter. It provides the user with signal scaling, track/hold, A/D converter, and serial interface logic functions on a single chip. The A/D converter section of the AD7898 consists of a conventional successive-approximation converter based around an R-2R ladder structure. The signal scaling on the AD7898-10 and AD7898-3 allows the part to handle ± 10 V and ± 2.5 V input signals, respectively, while operating from a single 5 V supply. The part requires an external 2.5 V reference. The reference input to the part is buffered on-chip. The AD7898 has two operating modes, an internal clocking mode using an on-chip oscillator and an external clocking mode using the SCLK as the master clock. The latter mode features a power-down mechanism. These modes are discussed in more detail in the Operating Modes section.

A major advantage of the AD7898 is that it provides all of the above functions in an 8-lead SOIC package. This offers the user considerable spacing saving advantages over alternative solutions. The AD7898 consumes only 22.5 mW maximum, making it ideal for battery-powered applications.

In Mode 0 operation, conversion is initiated on the AD7898 by pulsing the $\overline{\text{CONVST}}$ input. On the falling edge of $\overline{\text{CONVST}}$, the on-chip track/hold goes from track to hold mode, and the conversion sequence is started. The conversion clock for the part is generated internally using a laser-trimmed clock oscillator circuit. Conversion time for the AD7898 is 3.3 μs , and the quiet time is 0.1 μs . To obtain optimum performance from the part in Mode 0, the read operation should not occur during the conversion.

In Mode 1 operation, conversion is initiated on the AD7898 by the falling edge of $\overline{\text{CS}}$. Sixteen SCLK cycles are required to complete the conversion and access the conversion result, after which time $\overline{\text{CS}}$ may be brought high. The internal oscillator is not used as the conversion clock in this mode as the SCLK is used instead. The maximum SCLK frequency is 3.7 MHz in Mode 1 providing a minimum conversion time of 4.33 μs . As in Mode 0, another conversion should not be initiated during the quiet time after the end of conversion.

Both of these modes of operation allow the part to operate at throughput rates up to 220 kHz and achieve data sheet specifications.

CIRCUIT DESCRIPTION

Analog Input Section

The AD7898 is offered as two part types: the AD7898-10, which handles a ± 10 V input voltage range; the AD7898-3, which handles input voltage range ± 2.5 V.

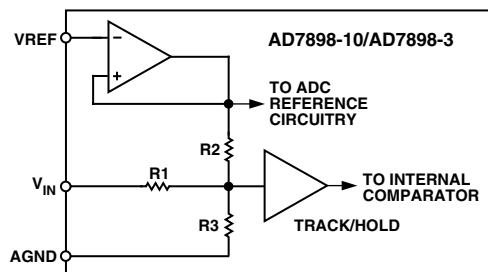

Figure 2. Analog Input Structure

Figure 2 shows the analog input section for the AD7898-10 and AD7898-3. The analog input range of the AD7898-10 is ± 10 V into an input resistance of typically 30 k Ω . The analog input range of the AD7898-3 is ± 2.5 V into an input resistance of typically 6 k Ω . This input is benign, with no dynamic charging currents, as the resistor stage is followed by a high input impedance stage of the track/hold amplifier. For the AD7898-10, R1 = 30 k Ω , R2 = 7.5 k Ω and R3 = 10 k Ω . For the AD7898-3, R1 = R2 = 6.5 k Ω and R3 is open circuit.

For the AD7898-10 and AD7898-3, the designed code transitions occur midway between successive LSB values (i.e., 1/2 LSB, 3/2 LSBs, 5/2 LSBs . . .). Output coding is twos complement binary with 1 LSB = FS/4096. For the AD7898-10 1 LSB = 20/4096 = 4.88 mV. For the AD7898-3 1 LSB = 5/4096 = 1.22 mV. The ideal input/output coding for the AD7898-10 and AD7898-3 is shown in Table I.

Table I. Ideal Input/Output Code Table for the AD7898-10/AD7898-3 Digital Output

Analog Input ¹	Code Transition
+FSR/2 – 3/2 LSB ²	011 . . . 110 to 011 . . . 111
+FSR/2 – 5/2 LSBs	011 . . . 101 to 011 . . . 110
+FSR/2 – 7/2 LSBs	011 . . . 100 to 011 . . . 101
AGND + 3/2 LSB	000 . . . 001 to 000 . . . 010
AGND + 1/2 LSB	000 . . . 000 to 000 . . . 001
AGND – 1/2 LSB	111 . . . 111 to 000 . . . 000
AGND – 3/2 LSB	111 . . . 110 to 111 . . . 111
–FSR/2 + 5/2 LSBs	100 . . . 010 to 100 . . . 011
–FSR/2 + 3/2 LSBs	100 . . . 001 to 100 . . . 010
–FSR/2 + 1/2 LSB	100 . . . 000 to 100 . . . 001

NOTES

¹FSR is full-scale range = 20 V (AD7898-10) and = 5 V (AD7898-3) with REF IN = 2.5 V.

²1 LSB = FSR/4096 = 4.883 mV (AD7898-10) and 1.22 mV (AD7898-3) with REF IN = 2.5 V.

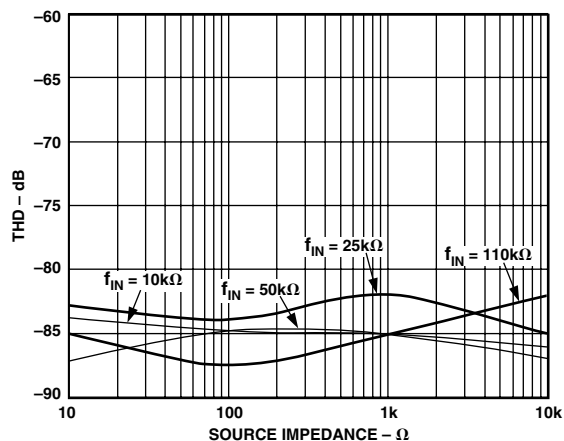

Figure 3. THD vs. Source Impedance for Various Analog Input Frequencies

Figure 3 shows a graph of THD versus source impedance for different analog input frequencies when using a supply voltage of 5 V, V_{DRIVE} of 5 V, and sampling at a rate of 220 kSPS. Source impedance has a minimal effect on THD because of the resistive ladder structure of the input section of the ADC. Figure 4 shows a graph of THD versus Analog input frequency for various supply voltages while sampling at 220 kSPS.

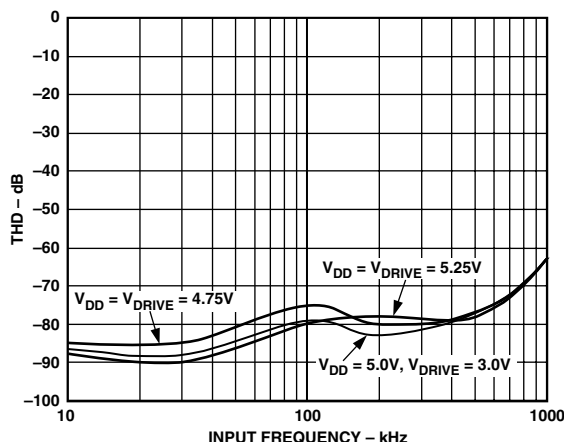

Figure 4. THD vs. Analog Input Frequency for Various Supply Voltages

Acquisition Time

The track-and-hold amplifier enters its tracking mode on the falling 14th SCLK edge after the CS falling edge for Mode 1 operation. The time required for the track-and-hold amplifier to acquire an input signal will depend on how quickly the 9.1 pF sampling capacitance is charged. With zero source impedance on the analog input, two SCLK cycles plus t_{QUIET} will always be sufficient to acquire the signal to the 12-bit level. With an SCLK frequency of 3.7 MHz, the acquisition time would be 2 × (270 ns) + t_{QUIET}.

The acquisition time required is calculated using the following formula:

$$t_{ACQ} = 10 \times (RC)$$

where R is the resistance seen by the track-and-hold amplifier looking back on the input e.g., for AD7898-10 R = 3.75 k Ω and for AD7898-3 R = 3.25 k Ω . The sampling capacitor has a value of 9.1 pF. Theoretical acquisition times would be 340 ns for AD7898-10, and 295 ns for AD7898-3. These theoretical values do not include t_{QUIET} or track propagation delays in the part, typical values would be 520 ns for the AD7898-10 and 450 ns for the AD7898-3.

AD7898

TYPICAL CONNECTION DIAGRAM

Figure 5 shows a typical connection diagram for the AD7898. The GND pin is connected to the analog ground plane of the system. REF IN is connected to a decoupled 2.5 V supply from a reference source, the AD780. This provides the analog reference for the part. The AD7898 is connected to a V_{DD} of 5 V, the serial interface is connected to a 3 V microprocessor. The V_{DRIVE} pin of the AD7898 is connected to the same 3 V supply as the microprocessor to allow a 3 V logic interface. The conversion result from the AD7898 is output in a 16-bit word with four leading zeros followed by the MSB of the 12-bit result. For applications where power consumption is of concern, the power-down mode should be used between conversions or bursts of several conversions to improve power performance. See Modes of Operation section.

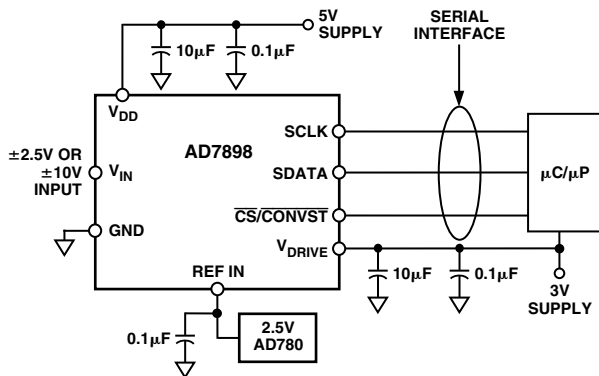

Figure 5. Typical Connection Diagram

V_{DRIVE} Feature

The AD7898 has the V_{DRIVE} feature. V_{DRIVE} controls the voltage at which the Serial Interface operates. V_{DRIVE} allows the ADC to easily interface to both 3 V and 5 V processors. For example, if the AD7898 were operated with a V_{DD} of 5 V, and the V_{DRIVE} pin could be powered from a 3 V supply. The AD7898 has good dynamic performance with a V_{DD} of 5 V while still being able to interface to 3 V digital parts. Care should be taken to ensure V_{DRIVE} does not exceed V_{DD} by more than 0.3 V (see Absolute Maximum Ratings section).

Track/Hold Section

The track/hold amplifier on the analog input of the AD7898 allows the ADC to accurately convert an input sine wave of full-scale amplitude to 12-bit accuracy. The input bandwidth of the track/hold is greater than the Nyquist rate of the ADC even when the ADC is operated at its maximum throughput rate of 220 kSPS (i.e., the track/hold can handle input frequencies in excess of 112 kHz). The track/hold amplifier acquires an input signal to 12-bit accuracy in less than 0.5 μ s.

The operation of the track/hold is essentially transparent to the user. When in operating Mode 0, the track/hold amplifier goes from its tracking mode to its hold mode at the start of conversion (i.e., the falling edge of $\overline{\text{CONVST}}$). The aperture time for the track/hold (i.e., the delay time between the external $\overline{\text{CONVST}}$ signal and the track/hold actually going into hold) is typically 15 ns. At the end of conversion (after 3.3 μ s max), the part returns to its tracking mode. The acquisition time of the track/hold amplifier begins at this point.

When in operating in Mode 1, the falling edge of $\overline{\text{CS}}$ will put track-and-hold into hold mode. On the 14th SCLK falling edge after the falling edge of $\overline{\text{CS}}$, the track-and-hold will go back into track (see Serial Interface section). The acquisition time of the track/hold amplifier begins at this point.

Reference Input

The reference input to the AD7898 is buffered on-chip with a maximum reference input current of 1 μ A. The part is specified with a 2.5 V reference input voltage. Errors in the reference source will result in gain errors in the AD7898's transfer function and will add to the specified full-scale errors on the part. Suitable reference sources for the AD7898 include the AD780 and AD680 precision 2.5 V references.

SERIAL INTERFACE

The serial interface to the AD7898 consists of just three wires: a serial clock input (SCLK), the serial data output (SDATA) and a $\overline{\text{CS/CONVST}}$ input depending on the mode of operation. This allows for an easy-to-use interface to most microcontrollers, DSP processors and shift registers. There is also a V_{DRIVE} pin that allows the serial interface to connect directly to either 3 V or 5 V processor systems independent of V_{DD} . The serial interface operation is different in Mode 0 and Mode 1 operation and is determined by which mode is selected. Upon power-up, the default mode of operation is Mode 0. To select Mode 1 operation see the Mode Selection section. The serial interface operation in Mode 0 and Mode 1 is described in detail in the Operating Modes section.

OPERATING MODES

Mode 0 Operation

The timing diagram in Figure 6 shows the AD7898 operating in Mode 0 where the falling edge of $\overline{\text{CONVST}}$ starts conversion and puts the track/hold amplifier into its hold mode. The conversion is complete 3.3 μ s max after the falling edge of $\overline{\text{CONVST}}$, and new data from this conversion is available in the output register of the AD7898. A read operation accesses this data. This read operation consists of 16 clock cycles and the length of this read operation will depend on the serial clock frequency. For the fastest throughput rate (with a serial clock of 15 MHz, 5 V operation) the read operation will take 1.066 μ s. Once the read operation has taken place, the required quiet time should be allowed before the next falling edge of $\overline{\text{CONVST}}$ to optimize the settling of the track/hold amplifier before the next conversion is initiated. A serial clock of less than 15 MHz can be used, but this will, in turn, mean that the throughput time will increase.

The read operation consists of 16 serial clock pulses to the output shift register of the AD7898. After 16 serial clock pulses, the shift register is reset, and the SDATA line is three-stated. If there are more serial clock pulses after the 16th clock, the shift register will be moved on past its reset state. However, the shift register will be reset again on the falling edge of the $\overline{\text{CONVST}}$ signal to ensure that the part returns to a known state after every conversion cycle. As a result, a read operation from the output register should not straddle the falling edge of $\overline{\text{CONVST}}$ as the output shift register will be reset in the middle of the read operation, and the data read back into the microprocessor will appear invalid.

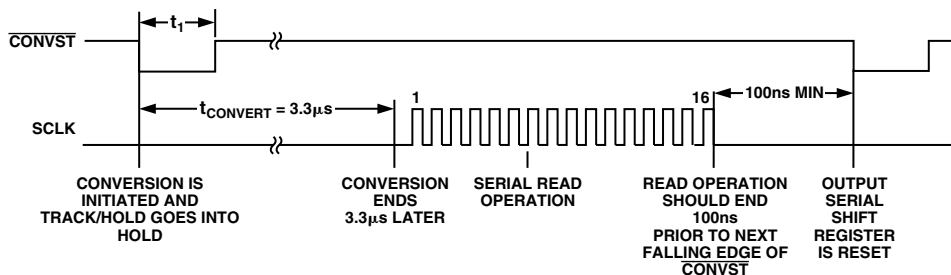

Figure 6. Serial Interface Timing Diagram Mode 0

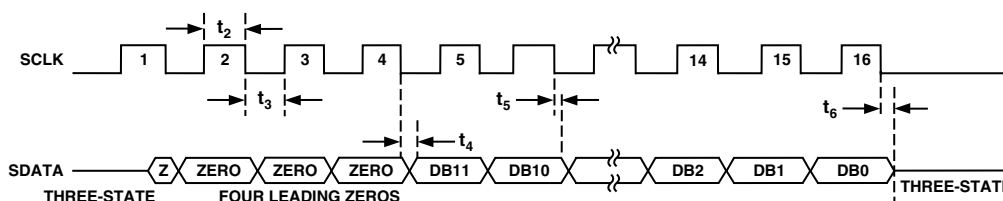

Figure 7. Data Read Operation in Mode 0

Figure 7 shows the timing diagram for the read operation to the AD7898 in Mode 0. The serial clock input (SCLK) provides the clock source for the serial interface. Serial data is clocked out from the SDATA line on the falling edge of this clock and is valid on both the rising and falling edges of SCLK, depending on the SCLK frequency used. The advantage of having the data valid on both the rising and falling edges of the SCLK is that it gives the user greater flexibility in interfacing to the part and allows a wider range of microprocessor and microcontroller interfaces to be accommodated. This also explains the two timing figures, t_4 and t_5 , that are quoted on the diagram.

The time, t_4 , specifies how long after the falling edge of the SCLK the next data bit becomes valid, whereas the time, t_5 , specifies for how long after the falling edge of the SCLK the current data bit is valid. The first leading zero is clocked out on the first rising edge of SCLK. Note that the first leading zero will be valid on the first falling edge of SCLK even though the data access time is specified at t_4 for the other bits (see Timing Specifications). The reason the first bit will be clocked out faster than the other bits is due to the internal architecture of the part. Sixteen clock pulses must be provided to the part to access to full conversion result. The AD7898 provides four leading zeros, followed by the 12-bit conversion result starting with the MSB (DB11). The last data bit to be clocked out on the 15th falling clock edge is the LSB (DB0). On the 16th falling edge of SCLK, the LSB (DB0) will be valid for a specified time to allow

the bit to be read on the falling edge of the SCLK, then the SDATA line is disabled (three-stated). After this last bit has been clocked out, the SCLK input should return low and remain low until the next serial data read operation. If there are extra clock pulses after the 16th clock, the AD7898 will start over, outputting data from its output register, and the data bus will no longer be three-stated even when the clock stops. Provided the serial clock has stopped before the next falling edge of $\overline{\text{CONVST}}$, the AD7898 will continue to operate correctly with the output shift register being reset on the falling edge of $\overline{\text{CONVST}}$. However, the SCLK line must be low when $\overline{\text{CONVST}}$ goes low in order to correctly reset the output shift register.

The 16 serial clock input does not have to be continuous during the serial read operation. The 16 bits of data (four leading zeros and 12-bit conversion result) can be read from the AD7898 in a number of bytes.

The AD7898 counts the serial clock edges to know which bit from the output register should be placed on the SDATA output. To ensure that the part does not lose synchronization, the serial clock counter is reset on the falling edge of the $\overline{\text{CONVST}}$ input, provided the SCLK line is low. The user should ensure that the SCLK line remains low until the end of the conversion. When the conversion is complete, the output register will be loaded with the new conversion result and can be read from the ADC with 16 clock cycles of SCLK.

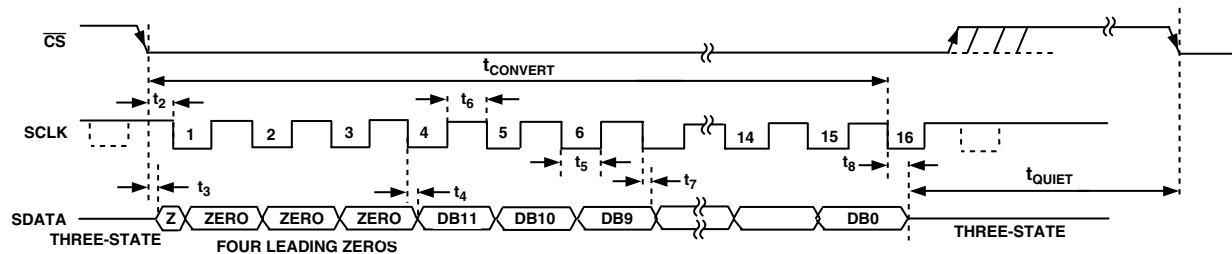

Figure 8. Serial Interface Timing Diagram Mode 1

Mode 1 Operation

The timing diagram in Figure 8 shows the AD7898 operating in Mode 1. The serial clock provides the conversion clock and also controls the transfer of information from the AD7898 during conversion.

\overline{CS} initiates the data transfer and conversion process. The falling edge of \overline{CS} puts the track-and-hold into hold mode, takes the bus out of three-state and the analog input is sampled at this point. The conversion is also initiated at this point and will require 16 SCLK cycles to complete. On the 14th SCLK falling edge the track-and-hold will go back into track. On the 16th SCLK falling edge the SDATA line will go back into three-state. If the rising edge of \overline{CS} occurs before 16 SCLKs have elapsed then the conversion will be terminated and the SDATA line will go back into three-state, otherwise SDATA returns to three-state on the 16th SCLK falling edge as shown in Figure 8.

Sixteen serial clock cycles are required to perform the conversion process and to access data from the AD7898. \overline{CS} going low provides the first leading zero to be read in by the microcontroller or DSP. The remaining data is then clocked out by subsequent SCLK falling edges beginning with the second leading zero, thus the first falling clock edge on the serial clock has the first leading zero provided and also clocks out the second leading zero. The final bit in the data transfer is valid on the 16th falling edge, having been clocked out on the previous (15th) falling edge. It is also possible to read in data on each SCLK rising edge, although the first leading zero will still have to be read on the first SCLK falling edge after the \overline{CS} falling edge. Therefore the first rising edge of SCLK after the \overline{CS} falling edge would provide the second leading zero and the 15th rising SCLK edge would have DB0 provided if the application requires data to be read on each rising edge.

Mode Selection

Upon power-up, the default mode of operation of the AD7898 is Mode 0. The part will continue to operate in Mode 0 as outlined in the Mode 0 Operation section, provided an SCLK edge is not applied to the AD7898 during the conversion time and when \overline{CONVST} is low. If an SCLK edge is applied to the AD7898 during $t_{CONVERT}$ and when \overline{CONVST} is low while in Mode 0, the part will switch to operate in Mode 1 as shown in Figure 9. The serial interface will now operate as described in the Mode 1 operation section. The AD7898 will return to Mode 0 operation from Mode 1 if \overline{CS} is brought low and then subsequently high without any SCLK edges provided while \overline{CS}

is low (see Figure 10). If any SCLK edges are applied to the device while \overline{CS} is low when in Mode 1, the part will remain in Mode 1 and may or may not enter a power-down mode as determined by the number of SCLKs applied, see Power-Down Mode section.

If the part is operating in Mode 0 and a glitch occurs on the SCLK line while \overline{CONVST} is low, the part will enter Mode 1 and the conversion that was initiated by \overline{CONVST} going low will be terminated. The part will now be operating in Mode 1, but Mode 0 signals will still be applied from the processor. When \overline{CS} goes low and no SCLK is applied, the part will revert back to Mode 0 operation. This avoids accidental changing of modes due to glitches on the SCLK line.

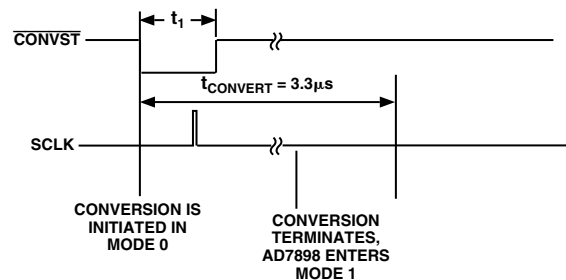

Figure 9. Entering Mode 1 from Mode 0

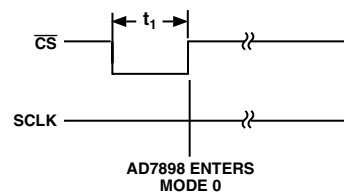

Figure 10. Entering Mode 0 from Mode 1

Power-Down Mode

The power-down mode is only accessible when in Mode 1 operation. This mode is intended for use in applications where slower throughput rates are required; either the ADC is powered down between each conversion, or a series of conversions may be performed at a high throughput rate and the ADC is powered down for a relatively long duration between these bursts of several conversions. When the AD7898 is in power-down, all analog circuitry is powered down.

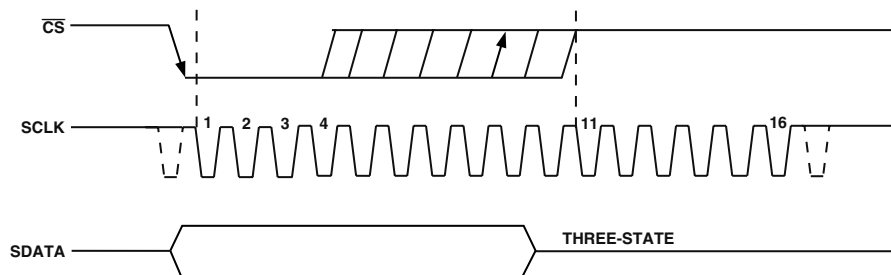

Figure 11. Entering Power-Down when in Mode 1

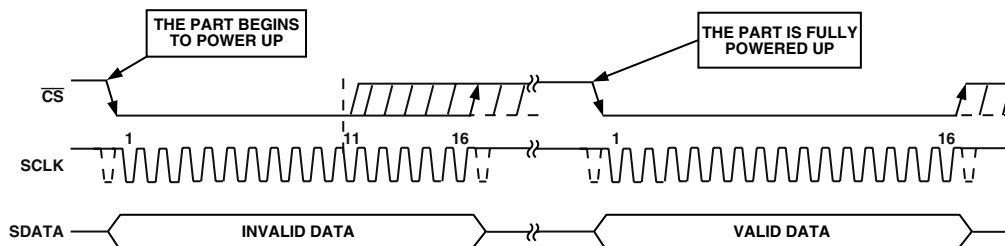

Figure 12. Exiting Power-Down when in Mode 1

To enter power-down, the conversion process must be interrupted by bringing \overline{CS} high anywhere after the fourth falling edge of SCLK and before the 11th falling edge of SCLK as shown in Figure 11. Once \overline{CS} has been brought high in this window of SCLK, then the part will enter power-down and the conversion that was initiated by the falling edge of \overline{CS} will be terminated and SDATA will go back into three-state.

In order to exit this mode of operation and power the AD7898 up again, a dummy conversion is performed. On the falling edge of \overline{CS} the device will begin to power up, and will continue to power up as long as \overline{CS} is held low until after the falling edge of the 11th SCLK. The device will be fully powered up once 16 SCLKs have elapsed and valid data will result from the next conversion as shown in Figure 12. If \overline{CS} is brought high before the 11th falling edge of SCLK, the AD7898 will go back into power-down. This avoids accidental power-up due to glitches on the \overline{CS} line or an inadvertent burst of eight SCLK cycles while \overline{CS} is low. So although the device may begin to power up on the falling edge of \overline{CS} , it will power down again on the rising edge of \overline{CS} as long as it occurs before the 11th SCLK falling edge.

Power-Up Times

The power-up time of the AD7898 is typically 4.33 μs , which means that with any frequency of SCLK up to 3.7 MHz, one dummy cycle will always be sufficient to allow the device to power up. Once the dummy cycle is complete, the ADC will be fully powered up and the input signal will be properly acquired. The quiet time, t_{QUIET} , must still be allowed from the point at which the bus goes back into three-state after the dummy conversion, to the next falling \overline{CS} edge.

When powering up from power-down mode at any SCLK frequency a dummy cycle is sufficient to power up the device and fully acquire V_{IN} ; it does not necessarily mean that a full dummy cycle of 16 SCLKs must always elapse to power up the device and fully acquire V_{IN} . 4.33 μs would be sufficient to power up the device and fully acquire V_{IN} . If, for example, a 1 MHz SCLK frequency was applied to the ADC, the cycle time would be 16 μs .

In one dummy cycle, 16 μs , the part would be powered up and V_{IN} fully acquired. However, after 4.33 μs with a 1 MHz SCLK just over four SCLK cycles would have elapsed. At this stage the ADC would be fully powered up and the signal acquired. So, in this case, \overline{CS} could be brought high after the 11th SCLK falling edge and brought low again after t_{QUIET} to initiate a new conversion.

MICROPROCESSOR/MICROCONTROLLER INTERFACE FOR MODE 0 OPERATION

The AD7898 provides a 3-wire serial interface that can be used for connection to the serial ports of DSP processors and microcontrollers. Figures 13 through 16 show the AD7898 interfaced to a number of different microcontrollers and DSP processors. The AD7898 accepts an external serial clock and, as a result, in all interfaces shown here, the processor/controller is configured as the master, providing the serial clock with the AD7898 configured as the slave in the system. The AD7898 has no BUSY signal, therefore a read operation should be timed to occur 3.3 μs after CONVST goes low.

8x51/L51 to AD7898 Interface

Figure 13 shows an interface between the AD7898 and the 8x51/L51 microcontroller. The 8x51/L51 is configured for its Mode 0 serial interface mode. The diagram shows the simplest form of the interface where the AD7898 is the only part connected to the serial port of the 8x51/L51 and, therefore, no decoding of the serial read operations is required.

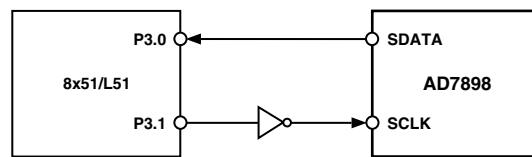

Figure 13. 8x51/L51 to AD7898 Interface

AD7898

To chip-select the AD7898 in systems where more than one device is connected to the 8x51/L51's serial port, a port bit configured as an output, from one of the 8x51/L51's parallel ports can be used to gate on or off the serial clock to the AD7898. A simple AND function on this port bit and the serial clock from the 8x51/L51 will provide this function. The port bit should be high to select the AD7898 and low when it is not selected.

The AD7898 outputs the MSB first during a read operation, while the 8xL51 expects the LSB first. Therefore, the data which is read into the serial buffer needs to be rearranged before the correct data format from the AD7898 appears in the accumulator.

The serial clock rate from the 8x51/L51 is limited to significantly less than the allowable input serial clock frequency with which the AD7898 can operate. As a result, the time to read data from the part will actually be longer than the conversion time of the part. This means that the AD7898 cannot run at its maximum throughput rate when used with the 8x51/L51.

68HC11/L11 to AD7898 Interface

An interface circuit between the AD7898 and the 68HC11/L11 microcontroller is shown in Figure 14. For the interface shown, the 68L11 SPI port is used, and the 68L11 is configured in its single-chip mode. The 68L11 is configured in the master mode with its CPOL bit set to a logic zero and its CPHA bit set to a logic one. As with the previous interface, the diagram shows the simplest form of the interface where the AD7898 is the only part connected to the serial port of the 68L11 and, therefore, no decoding of the serial read operations is required.

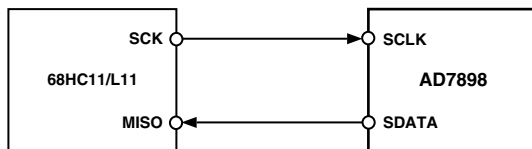

Figure 14. 68HC11/L11 to AD7898 Interface

Once again, to chip-select the AD7898 in systems where more than one device is connected to the 68HC11's serial port, a port bit configured as an output from one of the 68HC11's parallel ports can be used to gate on or off the serial clock to the AD7898. A simple AND function on this port bit and the serial clock from the 68L11 will provide this function. The port bit should be high to select the AD7898 and low when it is not selected.

The serial clock rate from the 68HC11/L11 is limited to significantly less than the allowable input serial clock frequency with which the AD7898 can operate. As a result, the time to read data from the part will actually be longer than the conversion time of the part. This means that the AD7898 cannot run at its maximum throughput rate when used with the 68HC11/L11.

ADSP-2103/ADSP-2105 to AD7898 Interface

An interface circuit between the AD7898 and the ADSP-2103/ADSP-2105 DSP processor is shown in Figure 15. In the interface shown, the RFS1 output from the ADSP-2103/ADSP-2105's SPORT1 serial port is used to gate the serial clock (SCLK1) of the ADSP-2103/ADSP-2105 before it is applied to the SCLK input of the AD7898. The RFS1 output is configured for active high operation. The interface ensures a noncontinuous clock for the AD7898's serial clock input with only 16 serial clock pulses provided and the serial clock line of the AD7898 remaining low between data transfers. A read operation should be timed to occur 3.3 μ s after $\overline{\text{CONVST}}$ goes low. The SDATA line from

the AD7898 is connected to the DR1 line of the ADSP-2103/ADSP-2105's serial port.

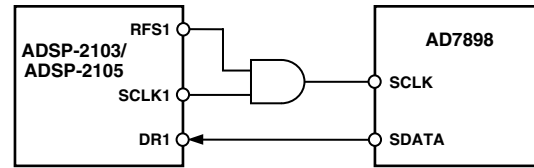

Figure 15. ADSP-2103/ADSP-2105 to AD7898 Interface

The timing relationship between the SCLK1 and RFS1 outputs of the ADSP-2103/ADSP-2105 are such that the delay between the rising edge of the SCLK1 and the rising edge of an active high RFS1 is up to 30 ns. There is also a requirement that data must be set up 10 ns prior to the falling edge of the SCLK1 to be read correctly by the ADSP-2103/ADSP-2105. The data access time for the AD7898 is t_4 (5 V) from the rising edge of its SCLK input. Assuming a 10 ns propagation delay through the external AND gate, the high time of the SCLK1 output of the ADSP-2105 must be $\geq (30 + 60 + 10 + 10)$ ns, i.e., ≥ 110 ns.

This means that the serial clock frequency with which the interface of Figure 15 can work is limited to 4.5 MHz. However, there is an alternative method that allows for the ADSP-2105 SCLK1 to run at 5 MHz (the max serial clock frequency of the SCLK1 output). The arrangement occurs when the first leading zero of the data stream from the AD7898 cannot be guaranteed to be clocked into the ADSP-2105 due to the combined delay of the RFS signal and the data access time of the AD7898. In most cases, this is acceptable because there will still be three leading zeros followed by the 12 data bits.

Another alternative scheme is to configure the ADSP-2103/ADSP-2105 so that it accepts an external noncontinuous serial clock. In this case, an external noncontinuous serial clock is provided that drives the serial clock inputs of both the ADSP-2103/ADSP-2105 and the AD7898. In this scheme, the serial clock frequency is limited to 15 MHz by the AD7898.

DSP56002/L002 to AD7898 Interface

Figure 16 shows an interface circuit between the AD7898 and the DSP56002/L002 DSP processor. The DSP56002/L002 is configured for normal mode asynchronous operation with gated clock. It is also set up for a 16-bit word with SCK as gated clock output. In this mode, the DSP56002/L002 provides sixteen serial clock pulses to the AD7898 in a serial read operation. Because the DSP56002/L002 assumes valid data on the first falling edge of SCK, the interface is simply 2-wire as shown in Figure 16.

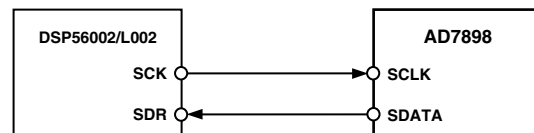

Figure 16. DSP56002/L002 to AD7898 Interface

MICROPROCESSOR INTERFACING FOR MODE 1

The serial interface on the AD7898 for Mode 1 allows the parts to be directly connected to a range of many different microprocessors. This section explains how to interface the AD7898 with some of the more common microcontroller and DSP serial interface protocols for Mode 1 operation.

TMS320C5x/C54x to AD7898 Interface

The serial interface on the TMS320C5x/C54x uses a continuous serial clock and frame synchronization signal to synchronize the data transfer operations with peripheral devices like the AD7898. The \overline{CS} input allows easy interfacing between the TMS320C5x/C54x and the AD7898 without any glue logic required. The serial port of the TMS320C5x/C54x is set up to operate in burst mode with internal CLKX (TX serial clock) and FSX (TX frame sync). The serial port control register (SPC) must have the following setup: FO = 0, FSM = 1, MCM = 1, and TXM = 1. The format bit, FO, may be set to 1 to set the word length to 8 bits, in order to implement the power-down modes on the AD7898.

The connection diagram is shown in Figure 17. It should be noted that for signal processing applications, it is imperative that the frame synchronization signal from the TMS320C5x/C54x will provide equidistant sampling. The V_{DRIVE} pin of the AD7898 takes the same supply voltage as that of the TMS320C5x/C54x. This allows the ADC to operate at a higher voltage than the serial interface, i.e., TMS320C5x/C54x, if necessary.

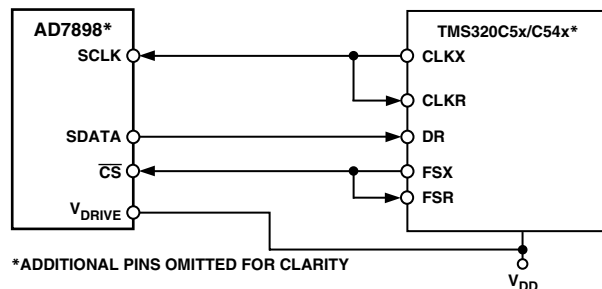

Figure 17. AD7898 to TMS320C5x Interface

AD7898 to ADSP-21xx Interface

The ADSP-21xx family of DSPs are interfaced directly to the AD7898 without any glue logic required. The V_{DRIVE} pin of the AD7898 takes the same supply voltage as that of the ADSP-21xx. This allows the ADC to operate at a higher voltage than the serial interface, i.e., ADSP-21xx, if necessary.

The SPORT control register should be set up as follows:
 TFSW = RFSW = 1, Alternate Framing
 INVRFS = INVTFS = 1, Active Low Frame Signal
 DTYPE = 00, Right Justify Data
 SLEN = 1111, 16-Bit Data Words
 ISCLK = 1, Internal Serial Clock
 TFSR = RFSR = 1, Frame Every Word
 IRFS = 0,
 ITFS = 1.

To implement the power-down mode, SLEN should be set to 1001 to issue an 8-bit SCLK burst.

The connection diagram is shown in Figure 18. The ADSP-21xx has the TFS and RFS of the SPORT tied together, with TFS set as an output and RFS set as an input. The DSP operates in Alternate Framing Mode and the SPORT control register is set up as described. The Frame Synchronization signal generated on the TFS is tied to \overline{CS} and as with all signal processing applications equidistant sampling is necessary. However, in this example, the timer interrupt is used to control the sampling rate of the ADC and, under certain conditions, equidistant sampling may not be achieved.

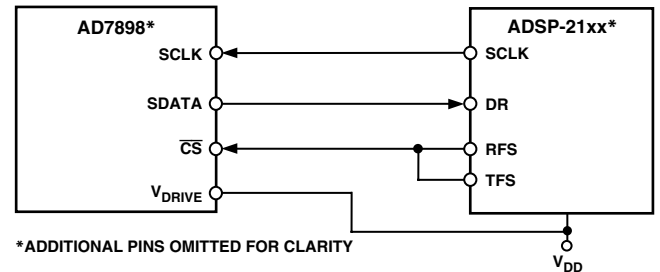

Figure 18. AD7898 to ADSP-21xx Interface

The Timer registers, among other things, are loaded with a value that will provide an interrupt at the required sample interval. When an interrupt is received, a value is transmitted with TFS/DT (ADC control word). The TFS is used to control the RFS and hence the reading of data. The frequency of the serial clock is set in the SCLKDIV register. When the instruction to transmit with TFS is given, (i.e., AX0 = TX0), the state of the SCLK is checked. The DSP will wait until the SCLK has gone high, low and high before transmission will start. If the timer and SCLK values are chosen such that the instruction to transmit occurs on or near the rising edge of SCLK, then the data may be transmitted or it may wait until the next clock edge.

For example, the ADSP-2111 has a master clock frequency of 16 MHz. If the SCLKDIV register is loaded with the value 3, a SCLK of 2 MHz is obtained, and eight master clock periods will elapse for every 1 SCLK period. If the timer registers are loaded with the value 803, 100.5 SCLKs will occur between interrupts and subsequently between transmit instructions. This situation will result in nonequidistant sampling as the transmit instruction is occurring on an SCLK edge. If the number of SCLKs between interrupts is a whole integer figure of N, equidistant sampling will be implemented by the DSP.

AD7898 to DSP56xxx Interface

The connection diagram in Figure 19 shows how the AD7898 can be connected to the SSI (Synchronous Serial Interface) of the DSP56xxx family of DSPs from Motorola. The SSI is operated in Synchronous Mode (SYN bit in CRB = 1) with internally generated 1-bit clock period frame sync for both TX and RX (bits FSL1 = 1 and FSL0 = 0 in CRB). Set the word length to 16 by setting bits WL1 = 1 and WL0 = 0 in CRA. To implement the power-down mode on the AD7898 then the word length can be changed to 8 bits by setting bits WL1 = 0 and WL0 = 0 in CRA. It should be noted that for signal processing applications, it is imperative that the frame synchronization signal from the DSP56xxx will provide equidistant sampling. The V_{DRIVE} pin of the AD7898 takes the same supply voltage as that of the DSP56xxx. This allows the ADC to operate at a higher voltage than the serial interface, i.e., DSP56xxx, if necessary.

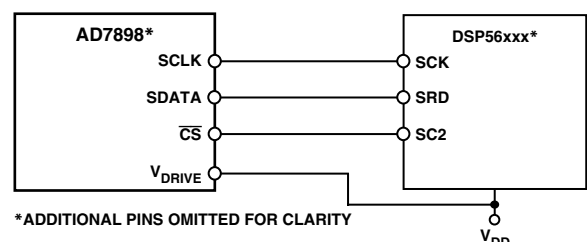

Figure 19. AD7898 to DSP56xxx Interface

AD7898

AD7898 to MC68HC16 Interface

The Serial Peripheral Interface (SPI) on the MC68HC16 is configured for Master Mode (MSTR = 1), Clock Polarity Bit (CPOL) = 1 and the Clock Phase Bit (CPHA) = 0. The SPI is configured by writing to the SPI Control Register (SPCR) (see 68HC16 user manual). The serial transfer will take place as a 16-bit operation when the SIZE bit in the SPCR register is set to SIZE = 1. To implement the power-down modes with an 8-bit transfer set SIZE = 0. A connection diagram is shown in Figure 20. The V_{DRIVE} pin of the AD7898 takes the same supply voltage as that of the MC68HC16. This allows the ADC to operate at a higher voltage than the serial interface, i.e., MC68HC16, if necessary.

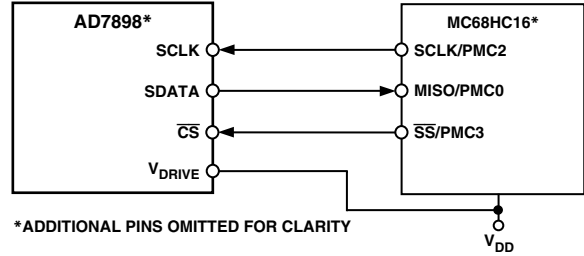

Figure 20. AD7898 to MC68HC16 Interface

C02145-0-3/04(A)

OUTLINE DIMENSIONS

8-Lead Standard Small Outline Package [SOIC] Narrow Body (R-8)

Dimensions shown in millimeters and (inches)

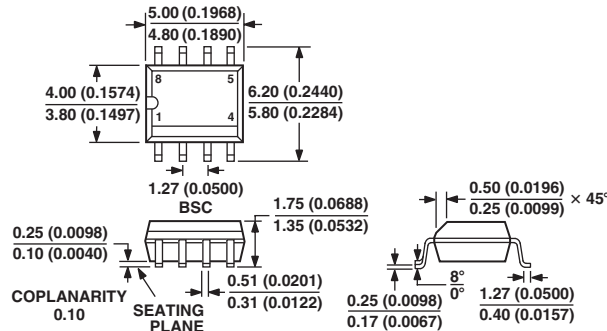

COMPLIANT TO JEDEC STANDARDS MS-012AA
CONTROLLING DIMENSIONS ARE IN MILLIMETERS; INCH DIMENSIONS
(IN PARENTHESES) ARE ROUNDED-OFF MILLIMETER EQUIVALENTS FOR
REFERENCE ONLY AND ARE NOT APPROPRIATE FOR USE IN DESIGN

Revision History

Location	Page
3/04—Data Sheet changed from REV. 0 to REV. A.	
Added Patent Note	1
Changes to ORDERING GUIDE	4
Updated OUTLINE DIMENSIONS	16