

FEATURES

Low cost single (**AD8057**) and dual (**AD8058**)

High speed

325 MHz, -3 dB bandwidth ($G = +1$)

1000 V/ μ s slew rate

Gain flatness: 0.1 dB to 28 MHz

Low noise

7 nV/ $\sqrt{\text{Hz}}$

Low power

5.4 mA/amplifier typical supply current at 5 V

Low distortion

-85 dBc at 5 MHz, $R_L = 1 \text{ k}\Omega$

Wide supply range from 3 V to 12 V

Small packaging

AD8057 is available in an 8-lead SOIC and 5-lead SOT-23

AD8058 is available in an 8-lead SOIC and an 8-lead MSOP

APPLICATIONS

Imaging

DVD/CD

Photodiode preamp

Analog-to-digital driver

Professional cameras filters

GENERAL DESCRIPTION

The **AD8057** (single) and **AD8058** (dual) are very high performance amplifiers with a very low cost. The balance between cost and performance make them ideal for many applications. The **AD8057** and **AD8058** reduce the need to qualify a variety of specialty amplifiers. The **AD8057** and **AD8058** are voltage feedback amplifiers with the bandwidth and slew rate normally found in current feedback amplifiers. The **AD8057** and **AD8058** are low power amplifiers having low quiescent current and a wide supply range from 3 V to 12 V. They have noise and distortion performance required for high end video systems as well as dc performance parameters rarely found in high speed amplifiers.

The **AD8057** and **AD8058** are available in standard SOIC packaging as well as tiny 5-lead SOT-23 (**AD8057**) and 8-lead MSOP (**AD8058**) packages. These amplifiers are available in the industrial temperature range of -40°C to $+85^\circ\text{C}$.

CONNECTION DIAGRAMS

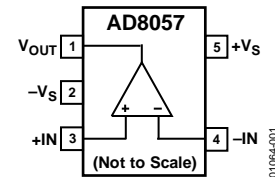

Figure 1. RT-5 (SOT-23)

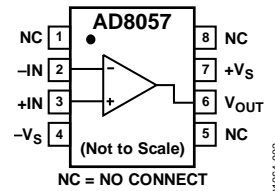

Figure 2. R-8 (SOIC)

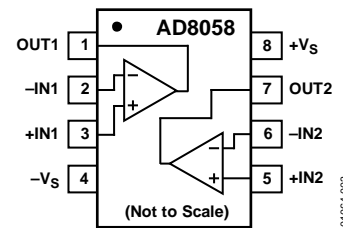

Figure 3. RM-8 (MSOP) and R-8 (SOIC)

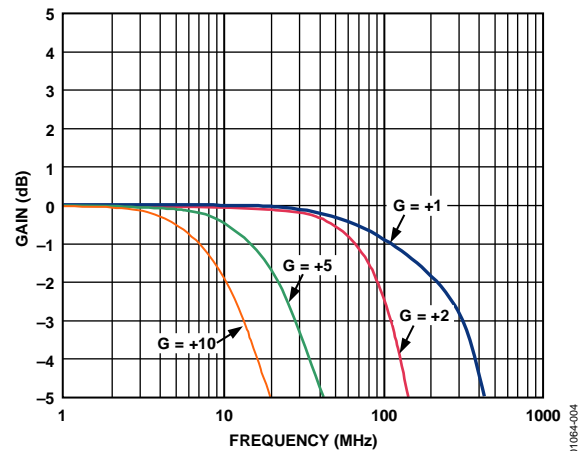

Figure 4. Small Signal Frequency Response

Rev. E

[Document Feedback](#)

Information furnished by Analog Devices is believed to be accurate and reliable. However, no responsibility is assumed by Analog Devices for its use, nor for any infringements of patents or other rights of third parties that may result from its use. Specifications subject to change without notice. No license is granted by implication or otherwise under any patent or patent rights of Analog Devices. Trademarks and registered trademarks are the property of their respective owners.

One Technology Way, P.O. Box 9106, Norwood, MA 02062-9106, U.S.A.
Tel: 781.329.4700 ©2010–2014 Analog Devices, Inc. All rights reserved.
Technical Support www.analog.com

TABLE OF CONTENTS

Features	1	Typical Performance Characteristics	6
Applications.....	1	Test Circuits.....	12
Connection Diagrams.....	1	Applications Information	13
General Description	1	Driving Capacitive Loads.....	13
Revision History	2	Video Filter.....	13
Specifications.....	3	Differential Analog-to-Digital Driver	14
Absolute Maximum Ratings.....	5	Layout	14
Maximum Power Dissipation	5	Outline Dimensions	15
ESD Caution.....	5	Ordering Guide	15

REVISION HISTORY

3/14—Rev. D to Rev. E

Change to Figure 48	14
---------------------------	----

9/13—Rev. C to Rev. D

Changes to Output Voltage Swing Parameter, Table 3	4
Updated Outline Dimensions	15
Changes to Ordering Guide	16

10/10—Rev. B to Rev. C

Updated Format.....	Universal
Change to Third-Order Intercept Parameter, Table 1	3
Changes to Input Common-Mode Voltage Range Parameter, Table 2	4
Changes to Figure 32.....	10
Changes to Figure 35.....	11
Changes to Figure 41 and Figure 42.....	12
Changes to Figure 44 and Figure 45.....	13
Changes to Ordering Guide	16

8/03—Rev. A to Rev. B

Renumbered Figures and TPCs.....	Universal
Changes to Ordering Guide	4
Change to Figure 8	12
Update Outline Dimensions	14

SPECIFICATIONS

At $T_A = 25^\circ\text{C}$, $V_S = \pm 5\text{ V}$, $R_L = 100\ \Omega$, $R_F = 0\ \Omega$, gain = +1, unless otherwise noted.

Table 1.

Parameter	Conditions	Min	Typ	Max	Unit
DYNAMIC PERFORMANCE					
-3 dB Bandwidth	$G = +1, V_O = 0.2\text{ V p-p}$		325		MHz
	$G = -1, V_O = 0.2\text{ V p-p}$		95		MHz
	$G = +1, V_O = 2\text{ V p-p}$		175		MHz
Bandwidth for 0.1 dB Flatness	$G = +1, V_O = 0.2\text{ V p-p}$		30		MHz
Slew Rate	$G = +1, V_O = 2\text{ V step}, R_L = 2\text{ k}\Omega$		850		V/ μs
	$G = +1, V_O = 4\text{ V step}, R_L = 2\text{ k}\Omega$		1150		V/ μs
Settling Time to 0.1%	$G = +2, V_O = 2\text{ V step}$		30		ns
NOISE/HARMONIC PERFORMANCE					
Total Harmonic Distortion	$f_c = 5\text{ MHz}, V_O = 2\text{ V p-p}, R_L = 1\text{ k}\Omega$		-85		dBc
	$f_c = 20\text{ MHz}, V_O = 2\text{ V p-p}, R_L = 1\text{ k}\Omega$		-62		dBc
SFDR	$f = 5\text{ MHz}, V_O = 2\text{ V p-p}, R_L = 150\ \Omega$		-68		dB
Third-Order Intercept	$f = 5\text{ MHz}, V_O = 2\text{ V p-p}$		-35		dBm
Crosstalk, Output to Output	$f = 5\text{ MHz}, G = +2$		-60		dB
Input Voltage Noise	$f = 100\text{ kHz}$		7		nV/ $\sqrt{\text{Hz}}$
Input Current Noise	$f = 100\text{ kHz}$		0.7		pA/ $\sqrt{\text{Hz}}$
Differential Gain Error	NTSC, $G = +2, R_L = 150\ \Omega$		0.01		%
	NTSC, $G = +2, R_L = 1\text{ k}\Omega$		0.02		%
Differential Phase Error	NTSC, $G = +2, R_L = 150\ \Omega$		0.15		Degrees
	NTSC, $G = +2, R_L = 1\text{ k}\Omega$		0.01		Degrees
Overload Recovery	$V_{IN} = 200\text{ mV p-p}, G = +1$		30		ns
DC PERFORMANCE					
Input Offset Voltage	T_{MIN} to T_{MAX}		1	5	mV
			2.5		mV
Input Offset Voltage Drift	T_{MIN} to T_{MAX}		3		$\mu\text{V}/^\circ\text{C}$
Input Bias Current			0.5	2.5	μA
			3.0		μA
Input Offset Current				± 0.75	μA
Open-Loop Gain	$V_O = \pm 2.5\text{ V}, R_L = 2\text{ k}\Omega$	50	55		dB
	$V_O = \pm 2.5\text{ V}, R_L = 150\ \Omega$	50	52		dB
INPUT CHARACTERISTICS					
Input Resistance			10		M Ω
Input Capacitance	+Input		2		pF
Input Common-Mode Voltage Range	$R_L = 1\text{ k}\Omega$	-4.0		+4.0	V
Common-Mode Rejection Ratio	$V_{CM} = \pm 2.5\text{ V}$	48	60		dB
OUTPUT CHARACTERISTICS					
Output Voltage Swing	$R_L = 2\text{ k}\Omega$	-4.0		+4.0	V
	$R_L = 150\ \Omega$		± 3.9		V
Capacitive Load Drive	30% overshoot		30		pF
POWER SUPPLY					
Operating Range		± 1.5	± 5.0	± 6	V
Quiescent Current for AD8057			6.0	7.5	mA
Quiescent Current for AD8058			14.0	15	mA
Power Supply Rejection Ratio	$V_S = \pm 5\text{ V to } \pm 1.5\text{ V}$	54	59		dB

At $T_A = 25^\circ\text{C}$, $V_S = 5\text{ V}$, $R_L = 100\ \Omega$, $R_F = 0\ \Omega$, gain = +1, unless otherwise noted.

Table 2.

Parameter	Conditions	Min	Typ	Max	Unit
DYNAMIC PERFORMANCE					
-3 dB Bandwidth	$G = +1, V_O = 0.2\text{ V p-p}$		300		MHz
	$G = +1, V_O = 2\text{ V p-p}$		155		MHz
Bandwidth for 0.1 dB Flatness	$V_O = 0.2\text{ V p-p}$		28		MHz
Slew Rate	$G = +1, V_O = 2\text{ V step}, R_L = 2\text{ k}\Omega$		700		V/ μs
Settling Time to 0.1%	$G = +2, V_O = 2\text{ V step}$		35		ns
NOISE/HARMONIC PERFORMANCE					
Total Harmonic Distortion	$f_C = 5\text{ MHz}, V_O = 2\text{ V p-p}, R_L = 1\text{ k}\Omega$		-75		dBc
	$f_C = 20\text{ MHz}, V_O = 2\text{ V p-p}, R_L = 1\text{ k}\Omega$		-54		dBc
Crosstalk, Output to Output	$f = 5\text{ MHz}, G = +2$		-60		dB
Input Voltage Noise	$f = 100\text{ kHz}$		7		nV/ $\sqrt{\text{Hz}}$
Input Current Noise	$f = 100\text{ kHz}$		0.7		pA/ $\sqrt{\text{Hz}}$
Differential Gain Error	NTSC, $G = +2, R_L = 150\ \Omega$		0.05		%
	NTSC, $G = +2, R_L = 1\text{ k}\Omega$		0.05		%
Differential Phase Error	NTSC, $G = +2, R_L = 150\ \Omega$		0.10		Degrees
	NTSC, $G = +2, R_L = 1\text{ k}\Omega$		0.02		Degrees
DC PERFORMANCE					
Input Offset Voltage			1	5	mV
	T_{MIN} to T_{MAX}		2.5		mV
Input Offset Voltage Drift			3		$\mu\text{V}/^\circ\text{C}$
Input Bias Current			0.5	2.5	μA
	T_{MIN} to T_{MAX}		3.0		μA
Input Offset Current				0.75	μA
Open-Loop Gain	$V_O = \pm 1.5\text{ V}, R_L = 2\text{ k}\Omega$ to midsupply	50	55		dB
	$V_O = \pm 1.5\text{ V}, R_L = 150\ \Omega$ to midsupply	45	52		dB
INPUT CHARACTERISTICS					
Input Resistance			10		M Ω
Input Capacitance	+Input		2		pF
Input Common-Mode Voltage Range	$R_L = 1\text{ k}\Omega$		0.9 to 3.4		V
Common-Mode Rejection Ratio	$V_{\text{CM}} = \pm 2.5\text{ V}$	48	60		dB
OUTPUT CHARACTERISTICS					
Output Voltage Swing	$R_L = 2\text{ k}\Omega$		0.9 to 3.8		V
	$R_L = 150\ \Omega$		1.2 to 3.4		V
Capacitive Load Drive	30% overshoot		30		pF
POWER SUPPLY					
Operating Range		3	5.0	10	V
Quiescent Current for AD8057			5.4	7.0	mA
Quiescent Current for AD8058			13.5	14	mA
Power Supply Rejection Ratio		54	58		dB

ABSOLUTE MAXIMUM RATINGS

Table 3.

Parameter	Rating
Supply Voltage (+V _S to -V _S)	12.6 V
Internal Power Dissipation ¹	
SOIC Package (R)	0.8 W
SOT-23-5 Package (RT)	0.5 W
MSOP Package (RM)	0.6 W
Input Voltage (Common Mode)	±V _S
Differential Input Voltage	±4.0 V
Output Short-Circuit Duration	Observe power derating curves
Storage Temperature Range (R)	-65°C to +125°C
Operating Temperature Range (A Grade)	-40°C to +85°C
Lead Temperature (Soldering 10sec)	300°C

¹ Specification is for device in free air:
 8-lead SOIC package: $\theta_{JA} = 160^{\circ}\text{C}/\text{W}$
 5-lead SOT-23-5 package: $\theta_{JA} = 240^{\circ}\text{C}/\text{W}$
 8-Lead MSOP package: $\theta_{JA} = 200^{\circ}\text{C}/\text{W}$

Stresses above those listed under Absolute Maximum Ratings may cause permanent damage to the device. This is a stress rating only; functional operation of the device at these or any other conditions above those indicated in the operational section of this specification is not implied. Exposure to absolute maximum rating conditions for extended periods may affect device reliability.

MAXIMUM POWER DISSIPATION

The maximum power that can be safely dissipated by the AD8057/AD8058 is limited by the associated rise in junction temperature. Exceeding a junction temperature of 175°C for an extended period can result in device failure. Although the AD8057/AD8058 is internally short-circuit protected, this may not be sufficient to guarantee that the maximum junction temperature (150°C) is not exceeded under all conditions. To ensure proper operation, it is necessary to observe the maximum power derating curves.

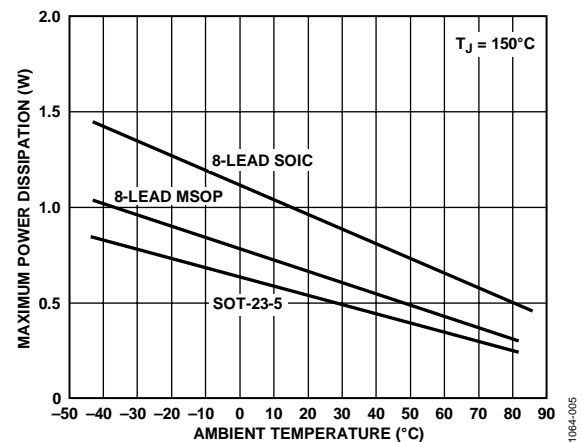

Figure 5. Maximum Power Dissipation vs. Ambient Temperature

ESD CAUTION



ESD (electrostatic discharge) sensitive device. Charged devices and circuit boards can discharge without detection. Although this product features patented or proprietary protection circuitry, damage may occur on devices subjected to high energy ESD. Therefore, proper ESD precautions should be taken to avoid performance degradation or loss of functionality.

TYPICAL PERFORMANCE CHARACTERISTICS

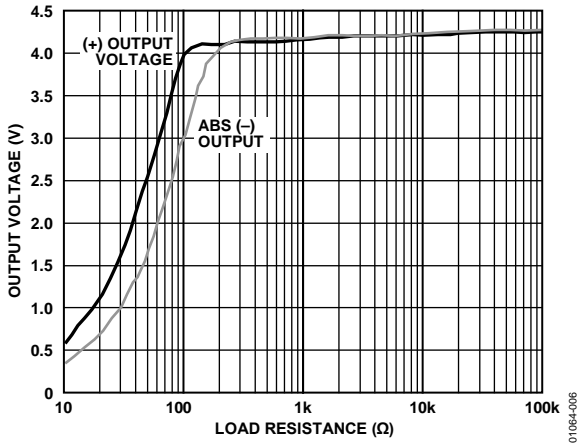

Figure 6. Output Swing vs. Load Resistance

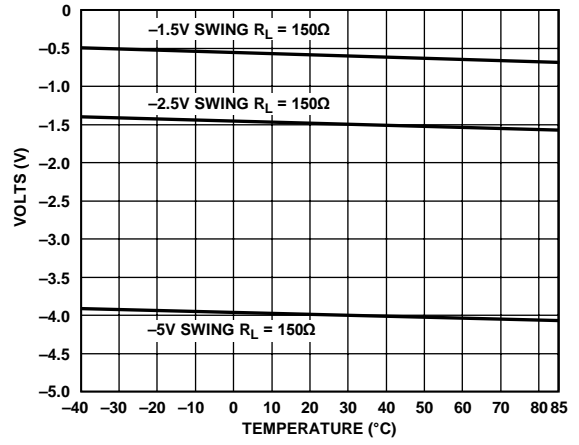

Figure 9. Negative Output Voltage Swing vs. Temperature

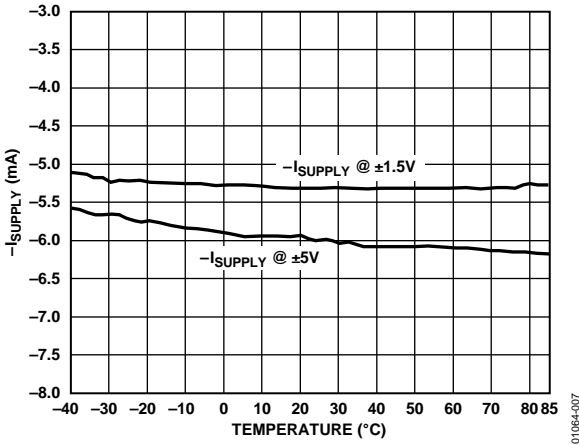

Figure 7. $-I_{SUPPLY}$ vs. Temperature

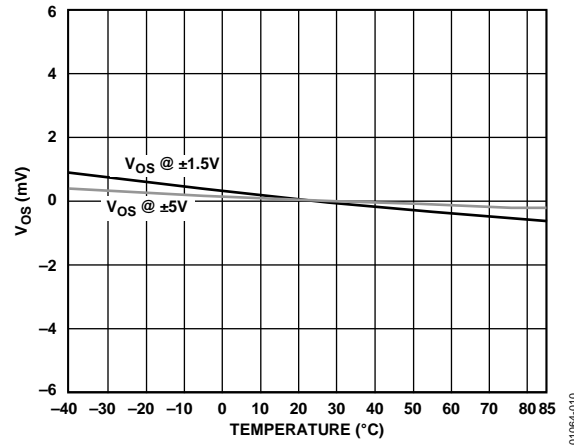

Figure 10. V_{OS} vs. Temperature

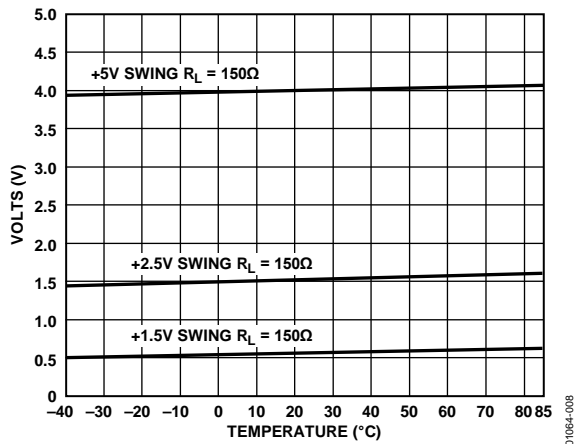

Figure 8. Positive Output Voltage Swing vs. Temperature

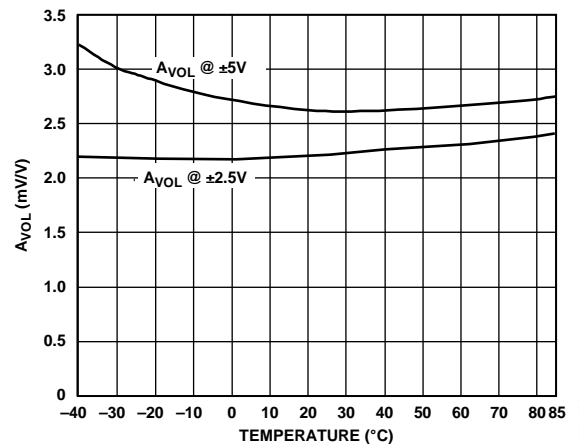

Figure 11. Open-Loop Gain vs. Temperature

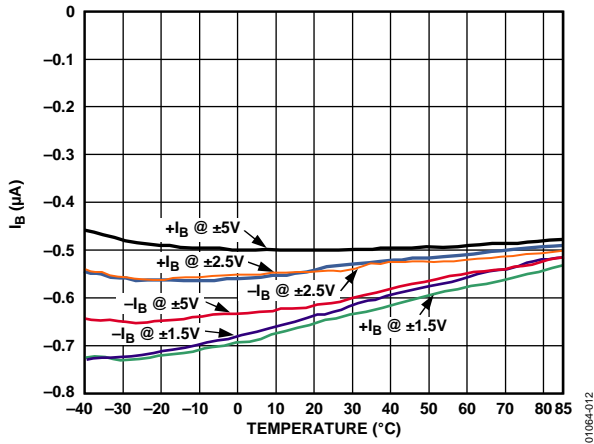

Figure 12. Input Bias Current vs. Temperature

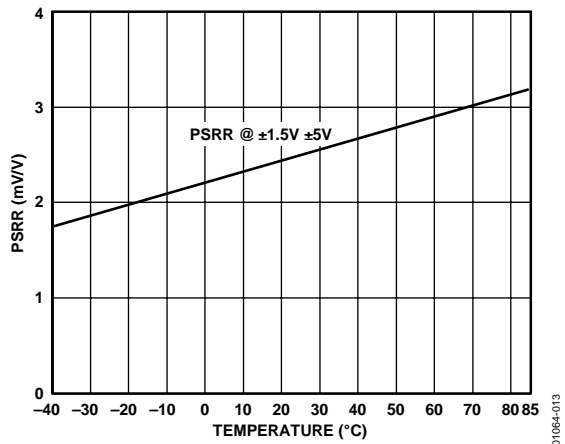

Figure 13. PSRR vs. Temperature

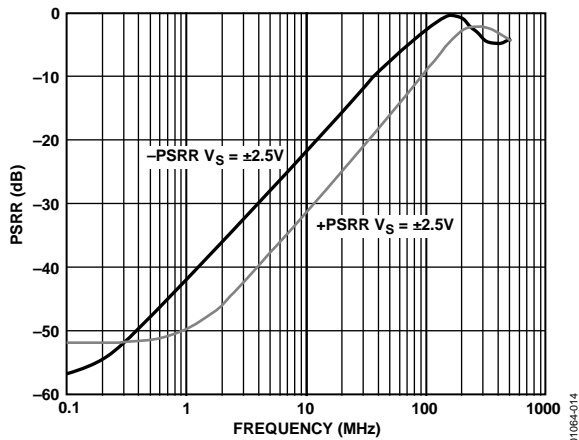

Figure 14. PSRR vs. Frequency

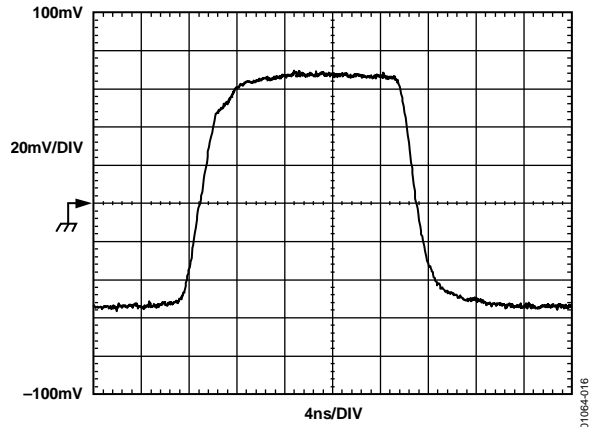

Figure 15. Small Signal Step Response $G = +1$, $R_L = 1 \text{ k}\Omega$, $V_S = \pm 5 \text{ V}$, See Figure 41 for Test Circuit

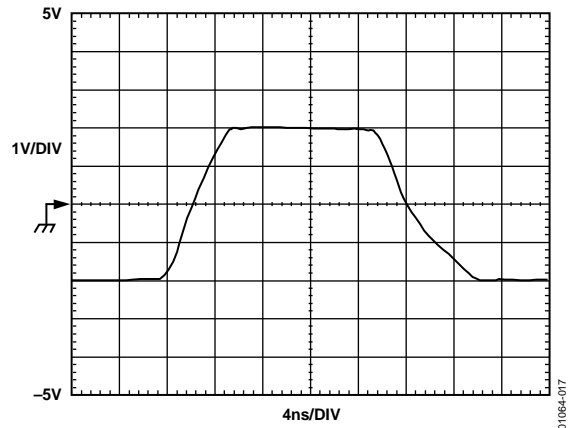

Figure 16. Large Signal Step Response $G = +1$, $R_L = 1 \text{ k}\Omega$, $V_S = \pm 5.0 \text{ V}$, See Figure 41 for Test Circuit

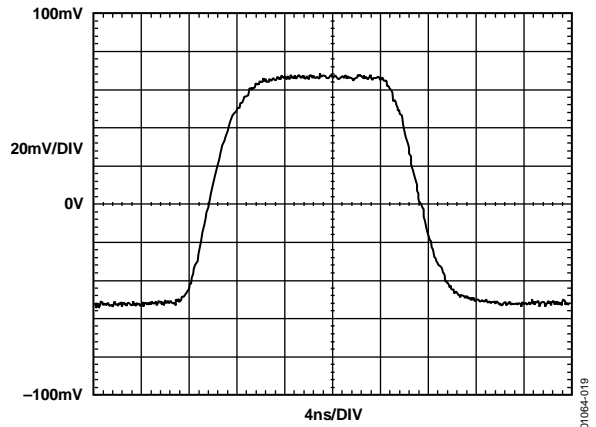

Figure 17. Small Signal Step Response $G = -1$, $R_L = 1 \text{ k}\Omega$, See Figure 42 for Test Circuit

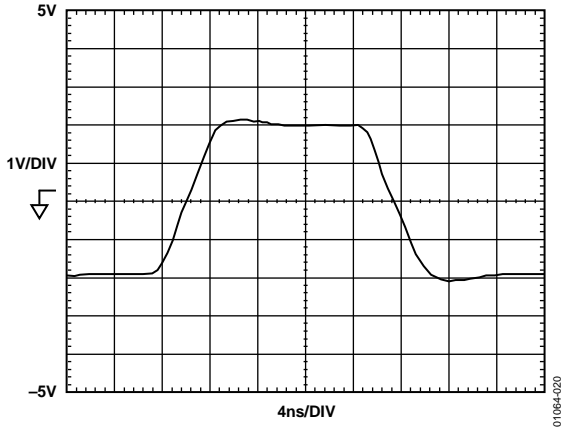

Figure 18. Large Signal Step Response $G = -1$, $R_L = 1\text{ k}\Omega$, See Figure 42 for Test Circuit

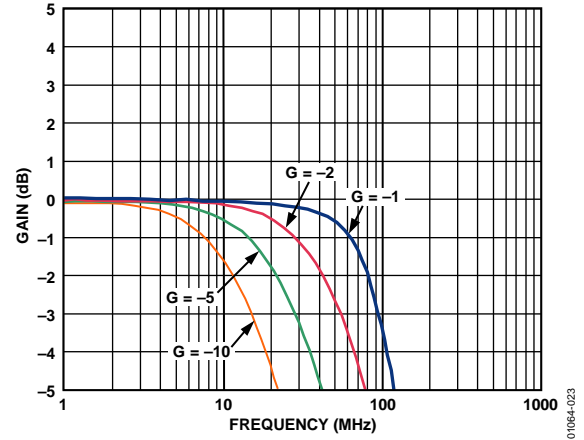

Figure 21. Large Signal Frequency Response

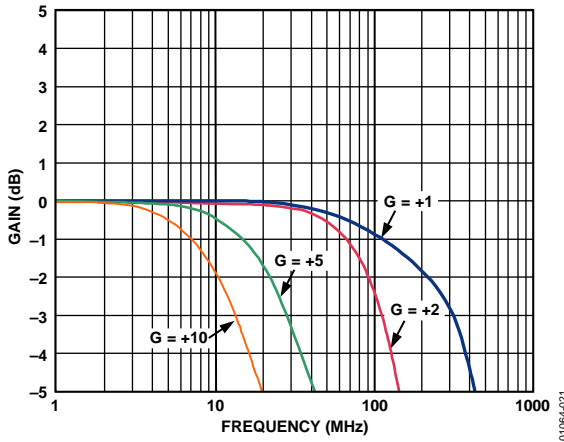

Figure 19. Small Signal Frequency Response, $V_{OUT} = 0.2\text{ V p-p}$

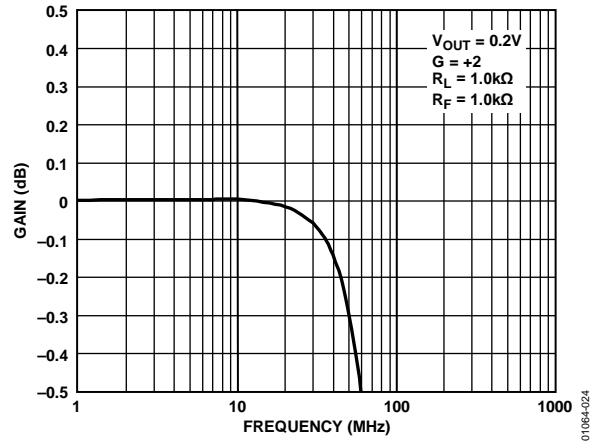

Figure 22. 0.1 dB Flatness $G = +2$

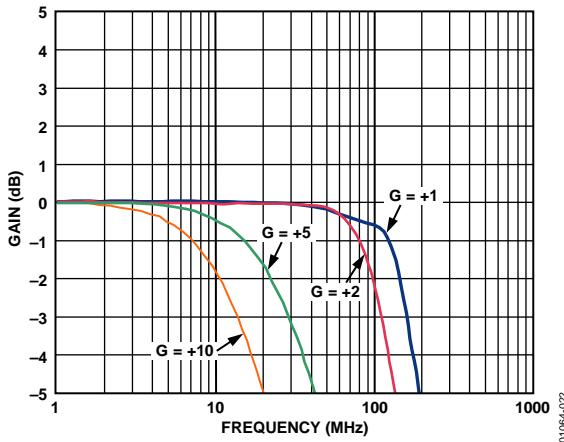

Figure 20. Large Signal Frequency Response, $V_{OUT} = 2\text{ V p-p}$

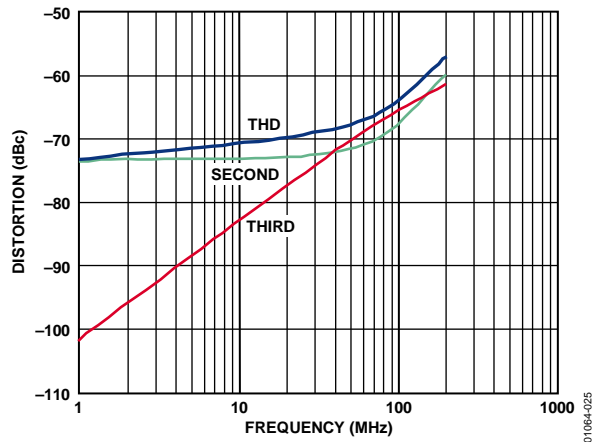

Figure 23. Distortion vs. Frequency, $R_L = 150\ \Omega$

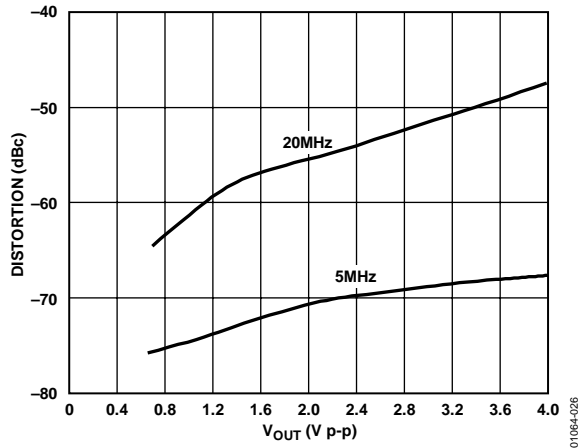

Figure 24. Distortion vs. V_{OUT} at 20 MHz, 5 MHz, $R_L = 150 \Omega$, $V_S = \pm 5.0 V$

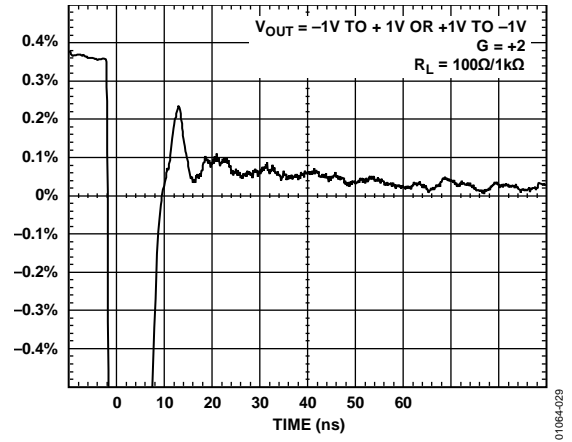

Figure 27. Settling Time

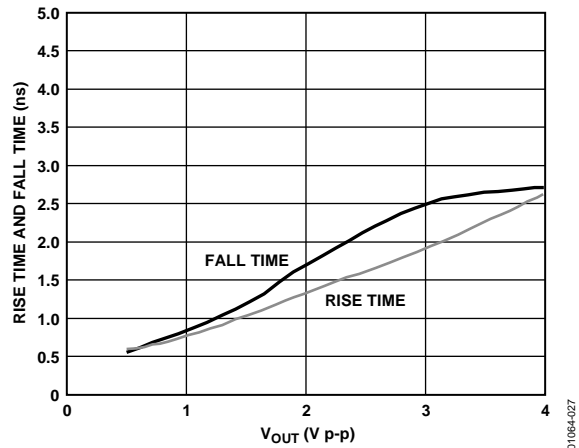

Figure 25. Rise Time and Fall Time vs. V_{OUT} , $G = +1$, $R_L = 1 k\Omega$, $R_F = 0 \Omega$

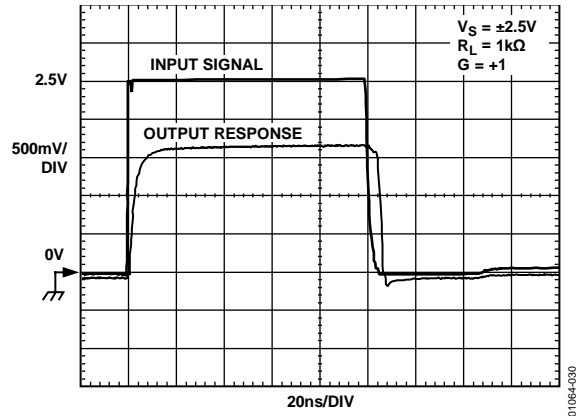

Figure 28. Input Overload Recovery, $V_S = \pm 2.5 V$

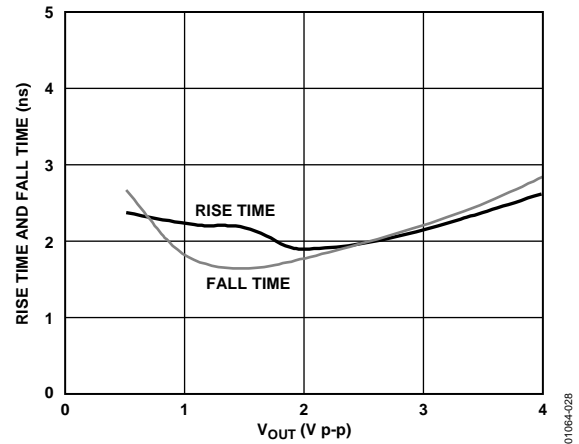

Figure 26. Rise Time and Fall Time vs. V_{OUT} , $G = +2$, $R_L = 100 \Omega$, $R_F = 402 \Omega$

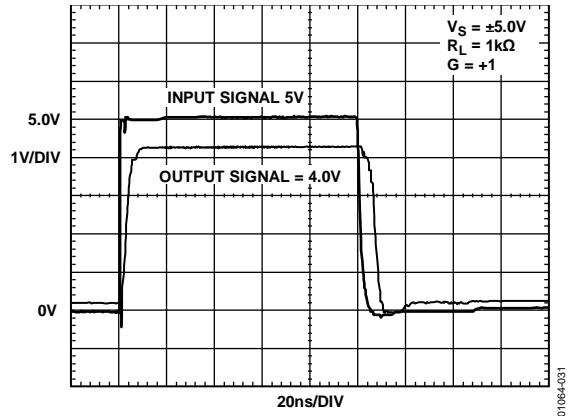

Figure 29. Output Overload Recovery, $V_S = \pm 5.0 V$

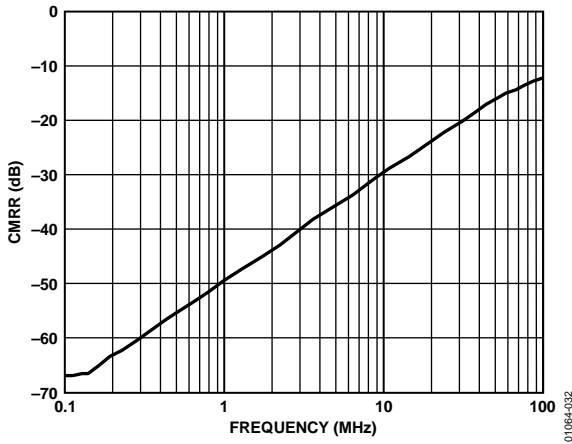

Figure 30. CMRR vs. Frequency

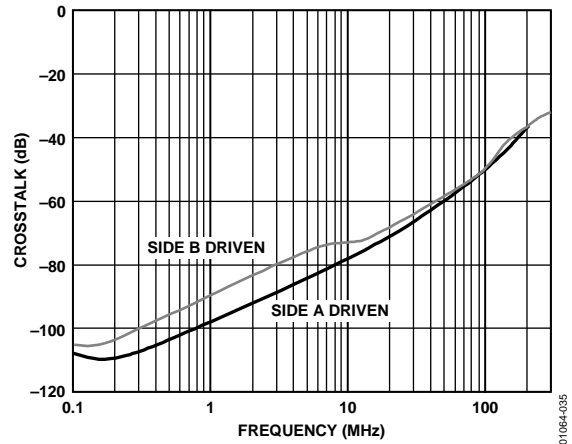

Figure 33. Crosstalk (Output-to-Output) vs. Frequency

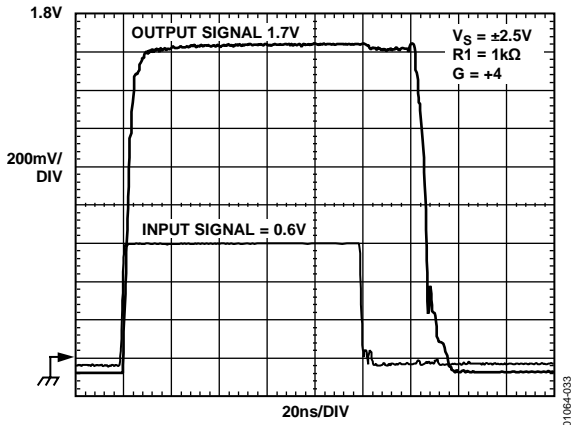

Figure 31. Output Overload Recovery, $V_S = \pm 2.5 V$

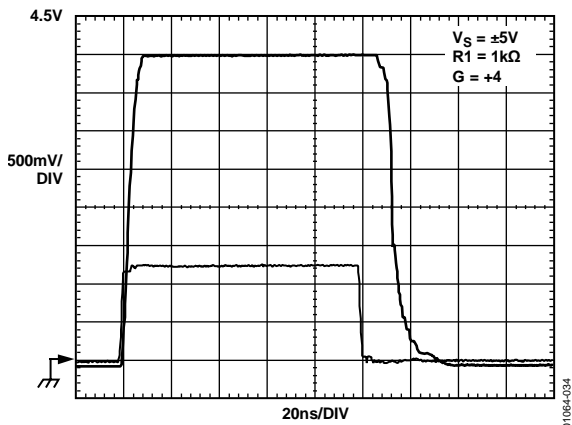

Figure 32. Output Overload Recovery, $V_S = \pm 5.0 V$

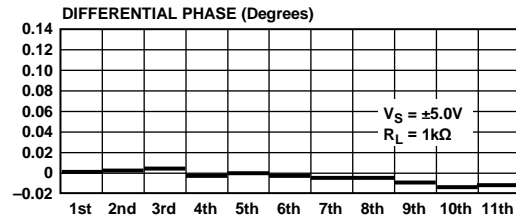
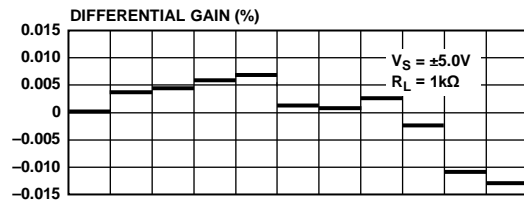
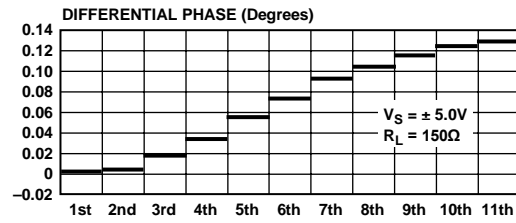
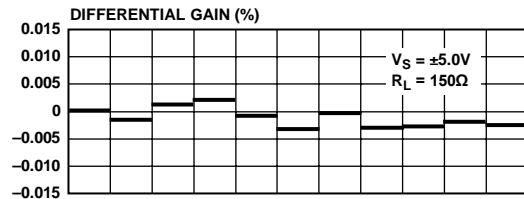

Figure 34. Differential Gain and Differential Phase One Back Terminated Load (150Ω) (Video Op Amps Only)

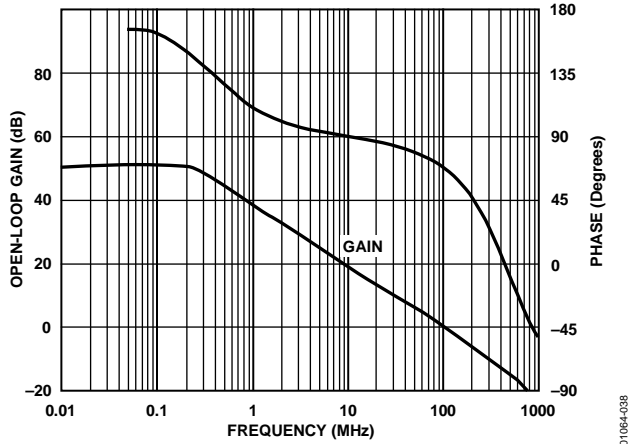

Figure 35. Open-Loop Gain and Phase vs. Frequency

01064-038

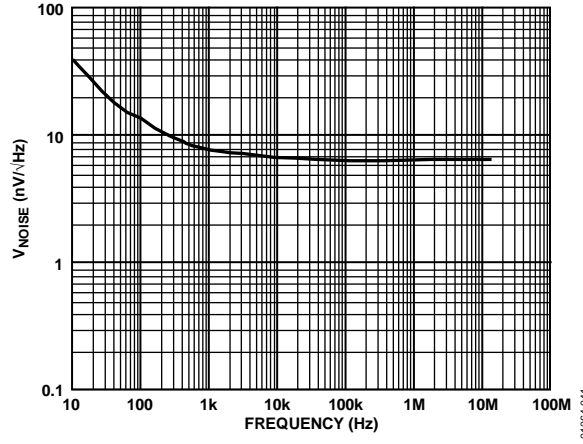

Figure 38. Voltage Noise vs. Frequency

01064-041

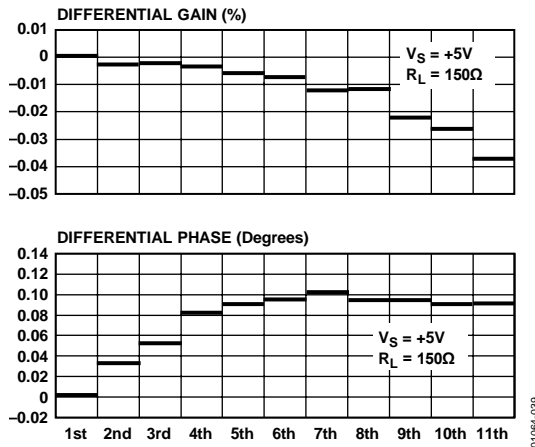

Figure 36. Differential Gain and Differential Phase, $R_L = 150\Omega$

01064-039

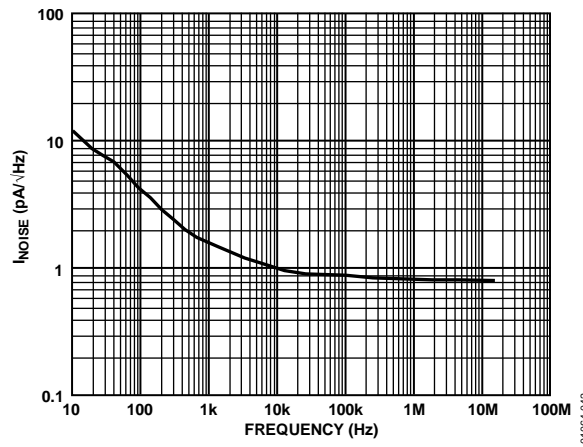

Figure 39. Current Noise vs. Frequency

01064-042

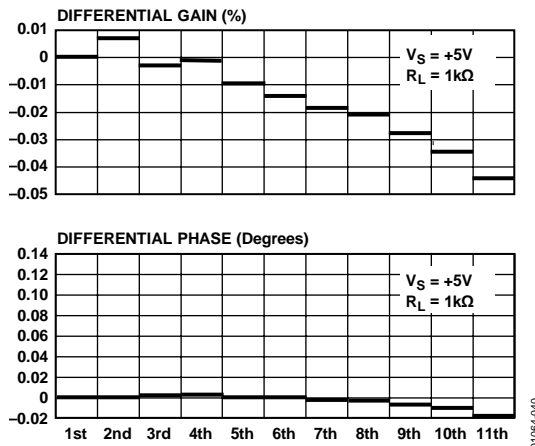

Figure 37. Differential Gain and Differential Phase, $R_L = 1k\Omega$

01064-040

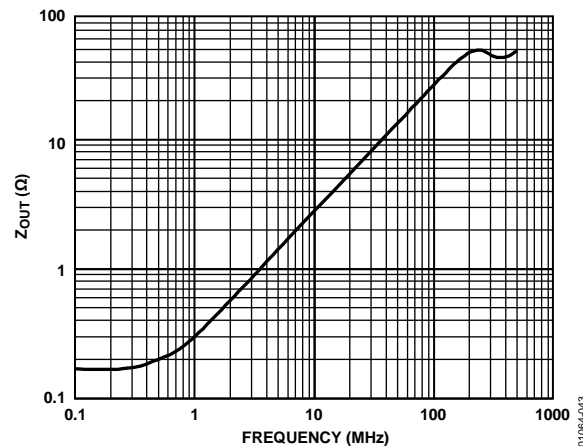

Figure 40. Output Impedance vs. Frequency

01064-043

TEST CIRCUITS

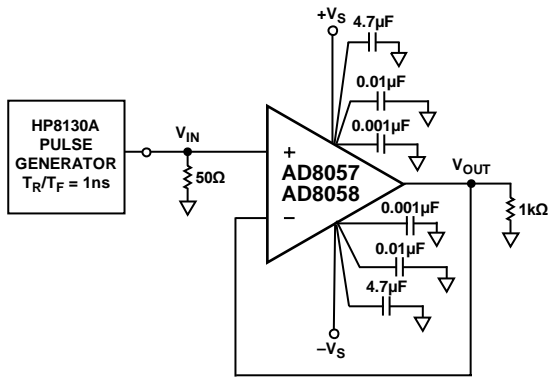

Figure 41. Test Circuit, $G = +1$, $R_L = 1\text{ k}\Omega$

01064-015

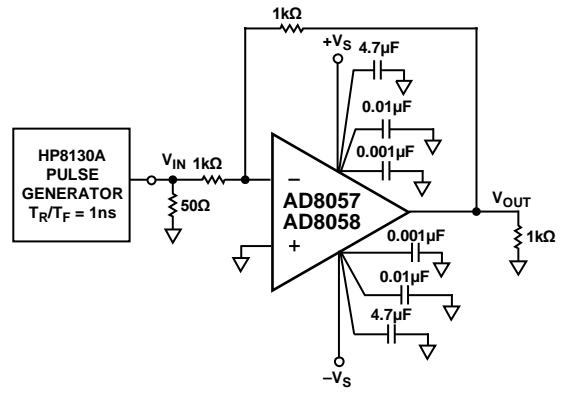

Figure 42. Test Circuit, $G = -1$, $R_L = 1\text{ k}\Omega$

01064-018

APPLICATIONS INFORMATION

DRIVING CAPACITIVE LOADS

When driving a capacitive load, most op amps exhibit overshoot in their pulse response. Figure 43 shows the relationship between the capacitive load that results in 30% overshoot and the closed-loop gain of an AD8058. It can be seen that, under the gain = +2 condition, the device is stable with capacitive loads of up to 69 pF.

In general, to minimize peaking or to ensure device stability for larger values of capacitive loads, a small series resistor (R_S) can be added between the op amp output and the load capacitor (C_L) as shown in Figure 44.

For the setup shown in Figure 44, the relationship between R_S and C_L was empirically derived and is shown in Table 4.

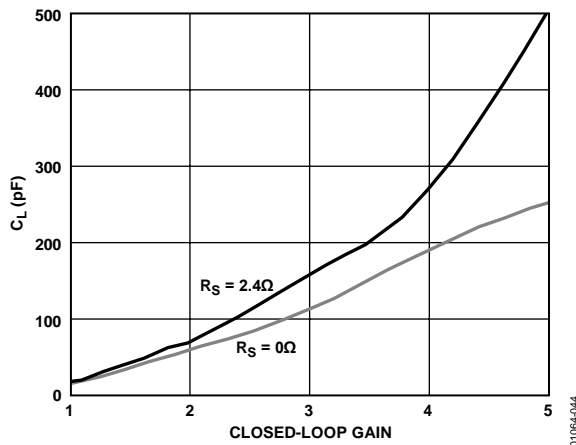

Figure 43. Capacitive Load Drive vs. Closed-Loop Gain

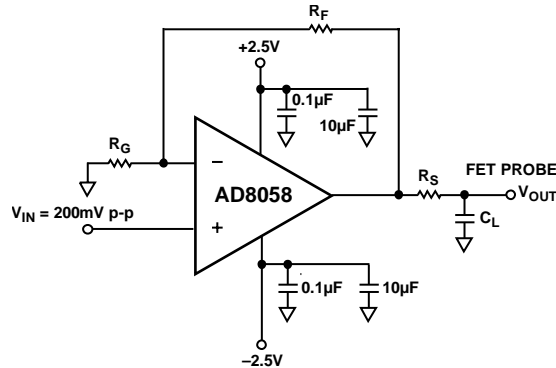

Figure 44. Capacitive Load Drive Circuit

Table 4. Recommended Value for Resistors R_S , R_F , R_G vs. Capacitive Load, C_L , Which Results in 30% Overshoot

Gain	R_F	R_G	C_L ($R_S = 0 \Omega$)	C_L ($R_S = 2.4 \Omega$)
1	100 Ω		11 pF	13 pF
2	100 Ω	100 Ω	51 pF	69 pF
3	100 Ω	50 Ω	104 pF	153 pF
4	100 Ω	33.2 Ω	186 pF	270 pF
5	100 Ω	25 Ω	245 pF	500 pF
10	100 Ω	11 Ω	870 pF	1580 pF

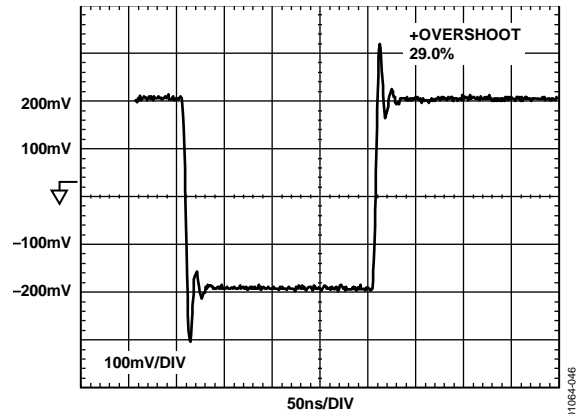

Figure 45. Typical Pulse Response with $C_L = 65$ pF, Gain = +2, and $V_S = \pm 2.5$

VIDEO FILTER

Some composite video signals that are derived from a digital source contain some clock feedthrough that can cause problems with downstream circuitry. This clock feedthrough is usually at 27 MHz, which is a standard clock frequency for both NTSC and PAL video systems. A filter that passes the video band and rejects frequencies at 27 MHz can be used to remove these frequencies from the video signal.

Figure 46 shows a circuit that uses an AD8057 to create a single 5 V supply, 3-pole Sallen-Key filter. This circuit uses a single RC pole in front of a standard 2-pole active section. To shift the dc operating point to midsupply, ac coupling is provided by R_4 , R_5 , and C_4 .

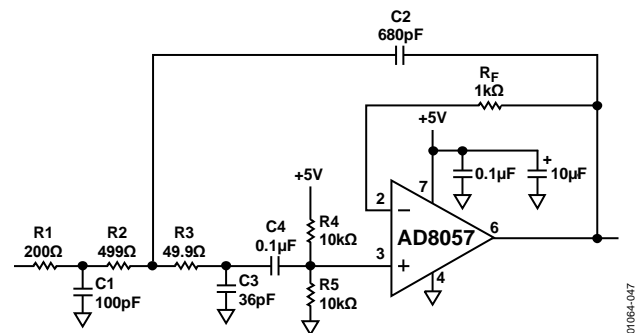

Figure 46. Low-Pass Filter for Video

Figure 47 shows a frequency sweep of this filter. The response is down 3 dB at 5.7 MHz; therefore, it passes the video band with little attenuation. The rejection at 27 MHz is 42 dB, which provides more than a factor of 100 in suppression of the clock components at this frequency.

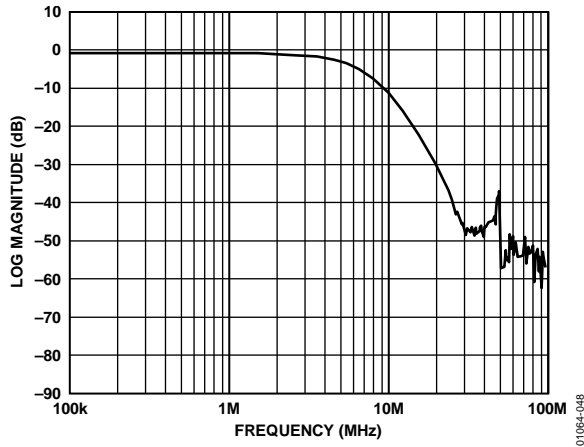

Figure 47. Video Filter Response

DIFFERENTIAL ANALOG-TO-DIGITAL DRIVER

As system supply voltages are dropping, many ADCs provide differential analog inputs to increase the dynamic range of the input signal while still operating on a low supply voltage. Differential driving can also reduce second and other even-order distortion products.

Analog Devices, Inc., offers an assortment of 12- and 14-bit high speed converters that have differential inputs and can be run from a single 5 V supply. These include the [AD9220](#), [AD9221](#), [AD9223](#), [AD9224](#), and [AD9225](#) at 12 bits, and the [AD9240](#), [AD9241](#), and [AD9243](#) at 14 bits. Although these devices can operate over a range of common-mode voltages at their analog inputs, they work best when the common-mode voltage at the input is at the midsupply or 2.5 V.

Op amp architectures that require upwards of 2 V of headroom at the output have significant problems when trying to drive such ADCs while operating with a 5 V positive supply. The low headroom output design of the [AD8057](#) and [AD8058](#) make them ideal for driving these types of ADCs.

The [AD8058](#) can be used to make a dc-coupled, single-ended-to-differential driver for one of these ADCs. Figure 48 is a schematic of such a circuit for driving an [AD9225](#), 12-bit, 25 MSPS ADC.

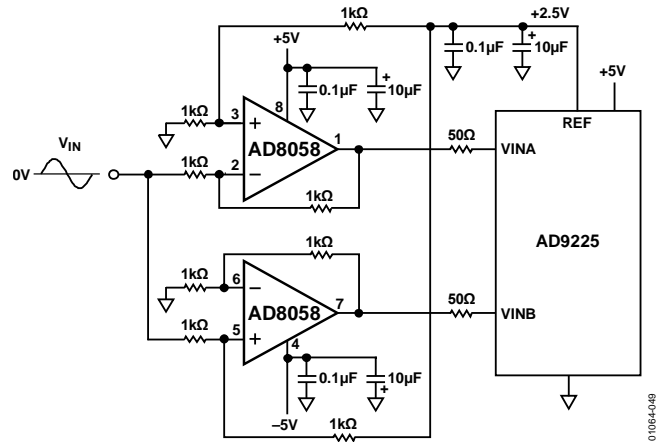

Figure 48. Schematic Circuit for Driving [AD9225](#)

In this circuit, one of the op amps is configured in the inverting mode whereas the other is in the noninverting mode. However, to provide better bandwidth matching, each op amp is configured for a noise gain of +2. The inverting op amp is configured for a gain of -1 and the noninverting op amp is configured for a gain of +2. Each of these produces a noise gain of +2, which is determined only by the inverse of the feedback ratio. The input signal to the noninverting op amp is divided by two to normalize its level and make it equal to the inverting output.

For 0 V input, the outputs of the op amps want to be at 2.5 V, which is the midsupply level of the ADCs. This is accomplished by first taking the 2.5 V reference output of the ADC and dividing it by two by a pair of 1 k Ω resistors. The resulting 1.25 V is applied to the positive input of each op amp. This voltage is then multiplied by the gain of +2 of the op amps to provide a 2.5 V level at each output.

The assumption for this circuit is that the input signal is bipolar with respect to ground and the circuit must be dc-coupled thereby implying the existence of a negative supply elsewhere in the system. This circuit uses -5 V as the negative supply for the [AD8058](#).

Tying the negative supply of the [AD8058](#) to ground causes a problem at the input of the noninverting op amp. The input common-mode voltage can only go to within 1 V of the negative rail. Because this circuit requires that the positive inputs operate with a 1.25 V bias, there is not enough room to swing this voltage in the negative direction. The inverting stage does not have this problem because its common-mode input voltage remains fixed at 1.25 V. If dc coupling is not required, various ac coupling techniques can be used to eliminate this problem.

LAYOUT

The [AD8057](#) and [AD8058](#) are high speed op amps for use in a board layout that follows standard high speed design rules. Make all signal traces as short and direct as possible. In particular, keep the parasitic capacitance on the inverting input of each device to a minimum to avoid excessive peaking and other undesirable performance. Bypass the power supplies very close to the power pins of the package with a 0.1 μ F capacitor in parallel with a larger (approximately 10 μ F) tantalum capacitor. Connect these capacitors to a ground plane that either is on an inner layer or fills the area of the board that is not used for other signals.

OUTLINE DIMENSIONS

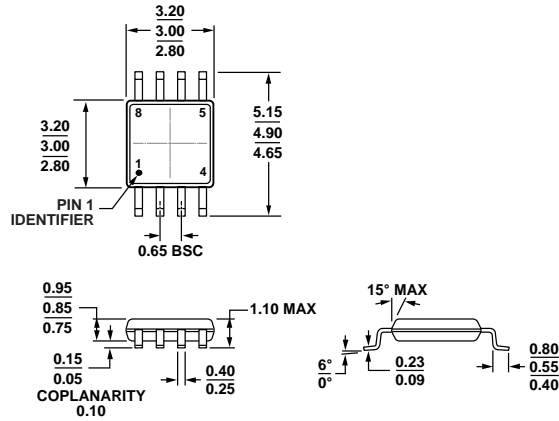

COMPLIANT TO JEDEC STANDARDS MO-187-AA

Figure 49. 8-Lead Mini Small Outline Package [MSOP] (RM-8)

Dimensions shown in millimeters

10-07-2009-B

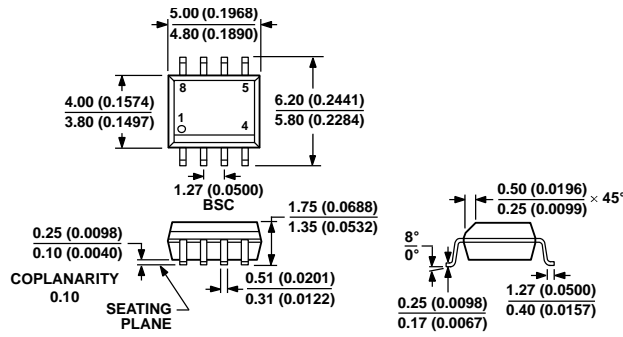

COMPLIANT TO JEDEC STANDARDS MS-012-AA
CONTROLLING DIMENSIONS ARE IN MILLIMETERS; INCH DIMENSIONS (IN PARENTHESES) ARE ROUNDED-OFF MILLIMETER EQUIVALENTS FOR REFERENCE ONLY AND ARE NOT APPROPRIATE FOR USE IN DESIGN.

Figure 50. 8-Lead Standard Small Outline Package [SOIC_N] Narrow Body (R-8)

Dimensions shown in millimeters and (inches)

012A07-A

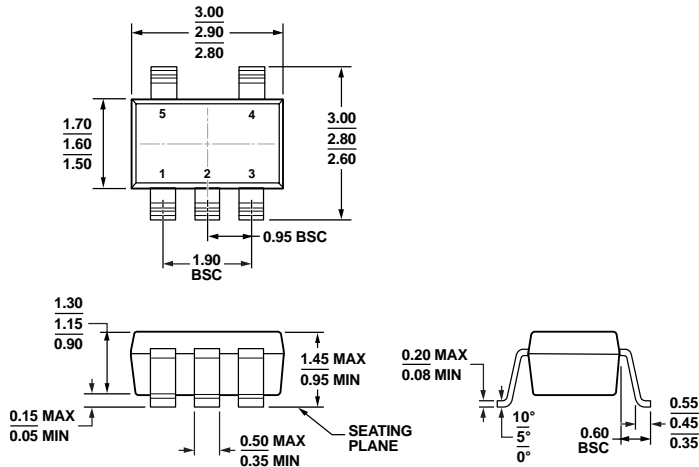

COMPLIANT TO JEDEC STANDARDS MO-178-AA
 Figure 51. 5-Lead Small Outline Transistor Package [SOT-23] (RJ-5)
 Dimensions shown in millimeters

11-01-2006A

ORDERING GUIDE

Model ¹	Notes	Temperature Range	Package Description	Package Option	Branding
AD8057AR		-40°C to +85°C	8-Lead SOIC_N	R-8	
AD8057AR-REEL		-40°C to +85°C	8-Lead SOIC_N, 13" Tape and Reel	R-8	
AD8057AR-REEL7		-40°C to +85°C	8-Lead SOIC_N, 7" Tape and Reel	R-8	
AD8057ARZ		-40°C to +85°C	8-Lead SOIC_N	R-8	
AD8057ARZ-REEL		-40°C to +85°C	8-Lead SOIC_N, 13" Tape and Reel	R-8	
AD8057ARZ-REEL7		-40°C to +85°C	8-Lead SOIC_N, 7" Tape and Reel	R-8	
AD8057ACHIPS		-40°C to +85°C	Die	Waffle Pak	
AD8057ART-R2		-40°C to +85°C	5-Lead SOT-23	RJ-5	H7A
AD8057ART-REEL7		-40°C to +85°C	5-Lead SOT-23	RJ-5	H7A
AD8057ARTZ-R2		-40°C to +85°C	5-Lead SOT-23	RJ-5	H08
AD8057ARTZ-REEL		-40°C to +85°C	5-Lead SOT-23	RJ-5	H08
AD8057ARTZ-REEL7		-40°C to +85°C	5-Lead SOT-23	RJ-5	H08
AD8057AR-EBZ		-40°C to +85°C	8-Lead SOIC_N Evaluation Board		
AD8057ART-EBZ		-40°C to +85°C	5-Lead SOT-23 Evaluation Board		
AD8058AR		-40°C to +85°C	8-Lead SOIC_N	R-8	
AD8058AR-REEL7		-40°C to +85°C	8-Lead SOIC_N, 7" Tape and Reel	R-8	
AD8058ARZ		-40°C to +85°C	8-Lead SOIC_N	R-8	
AD8058ARZ-REEL		-40°C to +85°C	8-Lead SOIC_N, 13" Tape and Reel	R-8	
AD8058ARZ-REEL7		-40°C to +85°C	8-Lead SOIC_N, 7" Tape and Reel	R-8	
AD8058ACHIPS		-40°C to +85°C	Die	Waffle Pak	
AD8058ARM		-40°C to +85°C	8-Lead MSOP	RM-8	H8A
AD8058ARM-REEL7		-40°C to +85°C	8-Lead MSOP	RM-8	H8A
AD8058ARMZ-REEL7	2	-40°C to +85°C	8-Lead MSOP	RM-8	H8A
AD8058ARMZ	2	-40°C to +85°C	8-Lead MSOP	RM-8	H8A
AD8058ARMZ-REEL	2	-40°C to +85°C	8-Lead MSOP	RM-8	H8A
AD8058AR-EBZ		-40°C to +85°C	8-Lead SOIC_N Evaluation Board		
AD8058ARM-EBZ		-40°C to +85°C	8-Lead MSOP Evaluation Board		

¹ Z = RoHS Compliant Part.

² Bottom mark has # sign before date code.