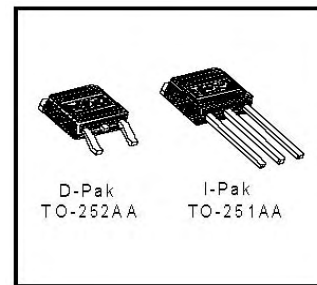
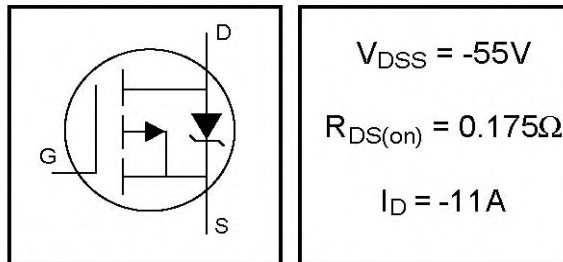


- Ultra Low On-Resistance
- P-Channel
- Surface Mount (IRFR9024N)
- Straight Lead (IRFU9024N)
- Advanced Process Technology
- Fast Switching
- Fully Avalanche Rated
- Lead-Free

HEXFET® Power MOSFET



**Description**

Fifth Generation HEXFETs from International Rectifier utilize advanced processing techniques to achieve extremely low on-resistance per silicon area. This benefit, combined with the fast switching speed and ruggedized device design that HEXFET Power MOSFETs are well known for, provides the designer with an extremely efficient and reliable device for use in a wide variety of applications.

The D-Pak is designed for surface mounting using vapor phase, infrared, or wave soldering techniques. The straight lead version (IRFU series) is for through-hole mounting applications. Power dissipation levels up to 1.5 watts are possible in typical surface mount applications.

**Absolute Maximum Ratings**

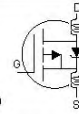
	Parameter	Max.	Units
$I_D @ T_C = 25^\circ C$	Continuous Drain Current, $V_{GS} @ -10V$	-11	A
$I_D @ T_C = 100^\circ C$	Continuous Drain Current, $V_{GS} @ -10V$	-8	
$I_{DM}$	Pulsed Drain Current ①	-44	
$P_D @ T_C = 25^\circ C$	Power Dissipation	38	W
	Linear Derating Factor	0.30	W/°C
$V_{GS}$	Gate-to-Source Voltage	$\pm 20$	V
$E_{AS}$	Single Pulse Avalanche Energy ②	62	mJ
$I_{AR}$	Avalanche Current ③	-6.6	A
$E_{AR}$	Repetitive Avalanche Energy ①	3.8	mJ
dv/dt	Peak Diode Recovery dv/dt ③	-10	V/ns
$T_J$ $T_{STG}$	Operating Junction and Storage Temperature Range	-55 to + 150	°C
	Soldering Temperature, for 10 seconds	300 (1.6mm from case )	

**Thermal Resistance**

	Parameter	Typ.	Max.	Units
$R_{\theta JC}$	Junction-to-Case	---	3.3	°C/W
$R_{\theta JA}$	Junction-to-Ambient (PCB mount)**	---	50	
$R_{\theta JA}$	Junction-to-Ambient	---	110	

## Electrical Characteristics @ T<sub>J</sub> = 25°C (unless otherwise specified)

	Parameter	Min.	Typ.	Max.	Units	Conditions
V <sub>(BR)DSS</sub>	Drain-to-Source Breakdown Voltage	-55	—	—	V	V <sub>GS</sub> = 0V, I <sub>D</sub> = -250μA
ΔV <sub>(BR)DSS/ΔT<sub>J</sub></sub>	Breakdown Voltage Temp. Coefficient	—	-0.05	—	V/°C	Reference to 25°C, I <sub>D</sub> = -1mA
R <sub>DS(on)</sub>	Static Drain-to-Source On-Resistance	—	—	0.175	Ω	V <sub>GS</sub> = -10V, I <sub>D</sub> = -6.6A ④
V <sub>GS(th)</sub>	Gate Threshold Voltage	-2.0	—	-4.0	V	V <sub>DS</sub> = V <sub>GS</sub> , I <sub>D</sub> = -250μA
g <sub>fs</sub>	Forward Transconductance	2.5	—	—	S	V <sub>DS</sub> = -25V, I <sub>D</sub> = -7.2A⑥
I <sub>DSS</sub>	Drain-to-Source Leakage Current	—	—	-25	μA	V <sub>DS</sub> = -55V, V <sub>GS</sub> = 0V
		—	—	-250		V <sub>DS</sub> = -44V, V <sub>GS</sub> = 0V, T <sub>J</sub> = 150°C
I <sub>GSS</sub>	Gate-to-Source Forward Leakage	—	—	100	nA	V <sub>GS</sub> = 20V
	Gate-to-Source Reverse Leakage	—	—	-100		V <sub>GS</sub> = -20V
Q <sub>g</sub>	Total Gate Charge	—	—	19	nC	I <sub>D</sub> = -7.2A
Q <sub>gs</sub>	Gate-to-Source Charge	—	—	5.1		V <sub>DS</sub> = -44V
Q <sub>gd</sub>	Gate-to-Drain ("Miller") Charge	—	—	10		V <sub>GS</sub> = -10V, See Fig. 6 and 13 ④⑥
t <sub>d(on)</sub>	Turn-On Delay Time	—	13	—	ns	V <sub>DD</sub> = -28V
t <sub>r</sub>	Rise Time	—	55	—		I <sub>D</sub> = -7.2A
t <sub>d(off)</sub>	Turn-Off Delay Time	—	23	—		R <sub>G</sub> = 24Ω
t <sub>f</sub>	Fall Time	—	37	—		R <sub>D</sub> = 3.7Ω, See Fig. 10 ④⑥
L <sub>D</sub>	Internal Drain Inductance	—	4.5	—	nH	Between lead, 6mm (0.25in.) from package and center of die contact⑤
L <sub>S</sub>	Internal Source Inductance	—	7.5	—		
C <sub>iss</sub>	Input Capacitance	—	350	—	pF	V <sub>GS</sub> = 0V
C <sub>oss</sub>	Output Capacitance	—	170	—		V <sub>DS</sub> = -25V
C <sub>rss</sub>	Reverse Transfer Capacitance	—	92	—		f = 1.0MHz, See Fig. 5⑥



## Source-Drain Ratings and Characteristics

	Parameter	Min.	Typ.	Max.	Units	Conditions
I <sub>S</sub>	Continuous Source Current (Body Diode)	—	—	-11	A	MOSFET symbol showing the integral reverse p-n junction diode.
I <sub>SM</sub>	Pulsed Source Current (Body Diode) ①	—	—	-44		
V <sub>SD</sub>	Diode Forward Voltage	—	—	-1.6	V	T <sub>J</sub> = 25°C, I <sub>S</sub> = -7.2A, V <sub>GS</sub> = 0V ④
t <sub>rr</sub>	Reverse Recovery Time	—	47	71	ns	T <sub>J</sub> = 25°C, I <sub>F</sub> = -7.2A
Q <sub>rr</sub>	Reverse Recovery Charge	—	84	130	nC	di/dt = 100A/μs ④⑥
t <sub>on</sub>	Forward Turn-On Time	Intrinsic turn-on time is negligible (turn-on is dominated by L <sub>S</sub> +L <sub>D</sub> )				

### Notes:

① Repetitive rating; pulse width limited by max. junction temperature. ( See fig. 11 )

② Starting T<sub>J</sub> = 25°C, L = 2.8mH  
R<sub>G</sub> = 25Ω, I<sub>AS</sub> = -6.6A. (See Figure 12)

③ I<sub>SD</sub> ≤ -6.6A, di/dt ≤ 240A/μs, V<sub>DD</sub> ≤ V<sub>(BR)DSS</sub>,  
T<sub>J</sub> ≤ 150°C

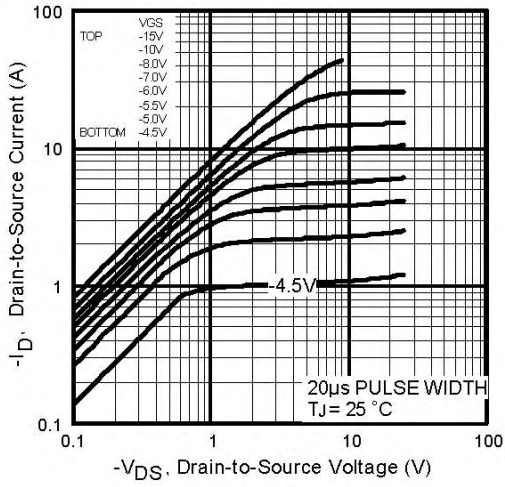
④ Pulse width ≤ 300μs; duty cycle ≤ 2%.

⑤ This is applied for I-PAK, L<sub>S</sub> of D-PAK is measured between lead and center of die contact

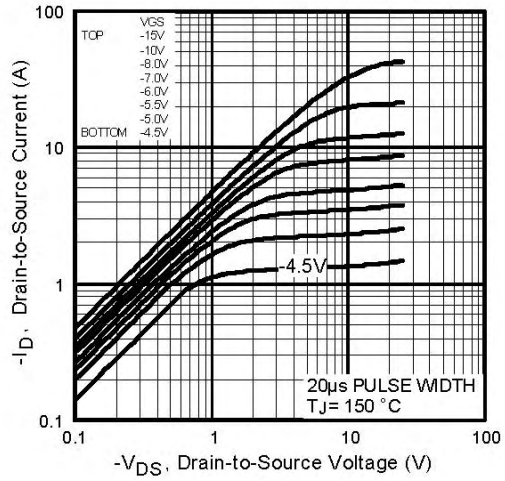
⑥ Uses IRF9Z24N data and test conditions.

\*\* When mounted on 1" square PCB (FR-4 or G-10 Material ) .

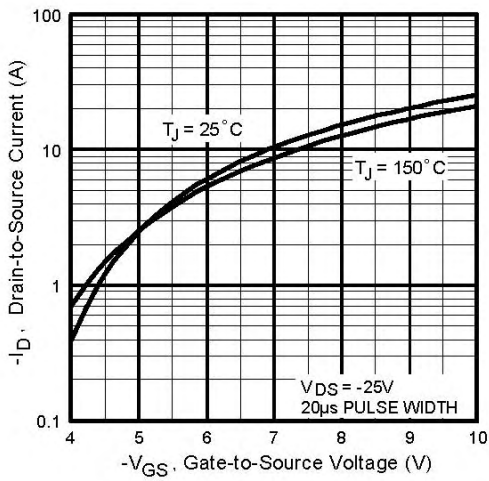
For recommended footprint and soldering techniques refer to application note #AN-994



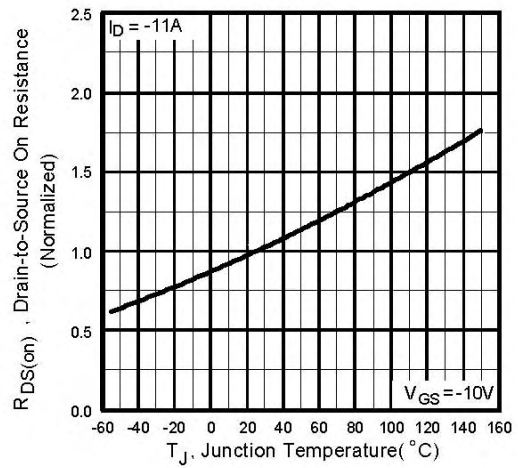
**Fig 1.** Typical Output Characteristics



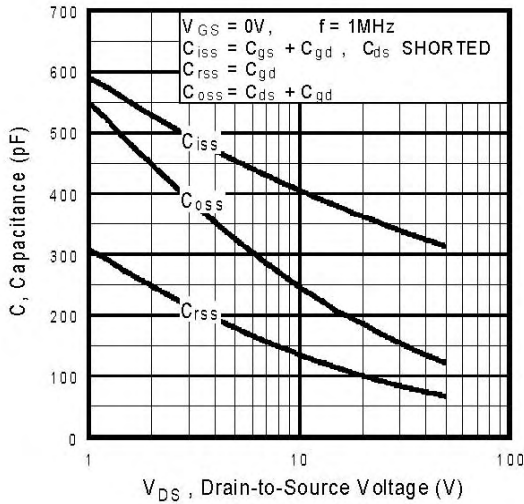
**Fig 2.** Typical Output Characteristics



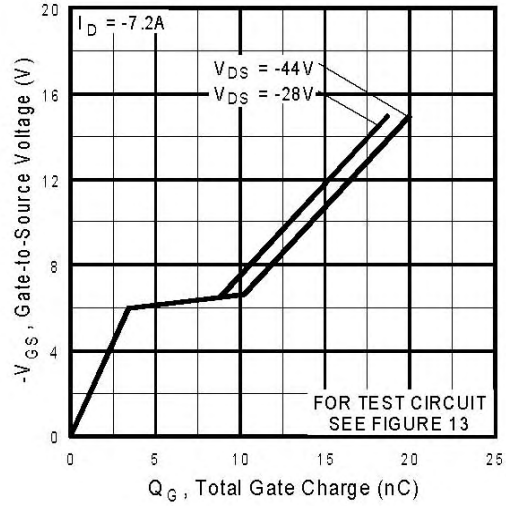
**Fig 3.** Typical Transfer Characteristics



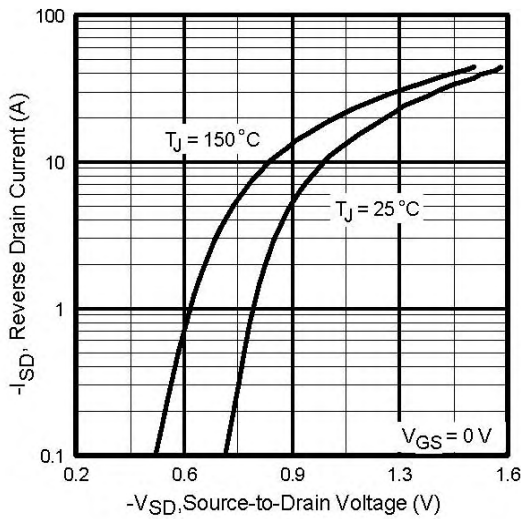
**Fig 4.** Normalized On-Resistance Vs. Temperature



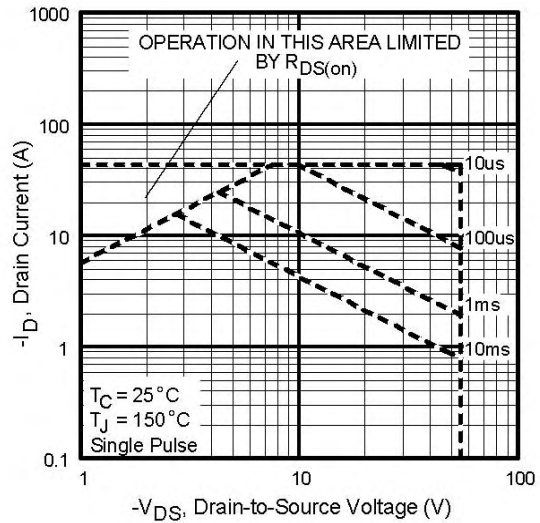
**Fig 5.** Typical Capacitance Vs. Drain-to-Source Voltage



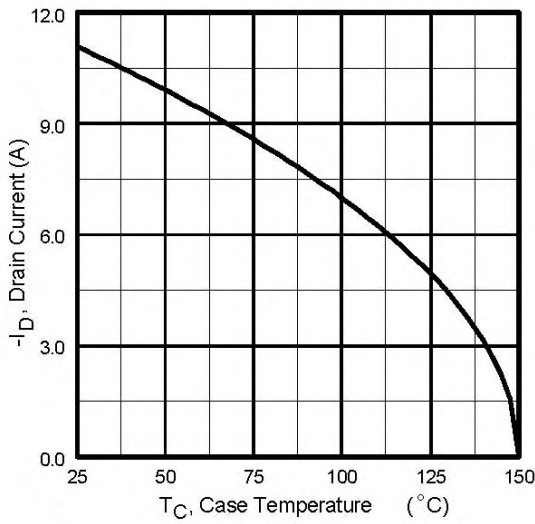
**Fig 6.** Typical Gate Charge Vs. Gate-to-Source Voltage



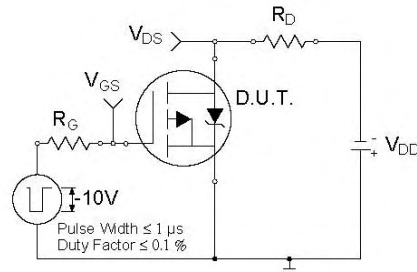
**Fig 7.** Typical Source-Drain Diode Forward Voltage



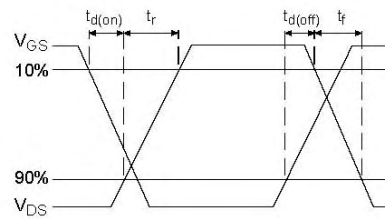
**Fig 8.** Maximum Safe Operating Area



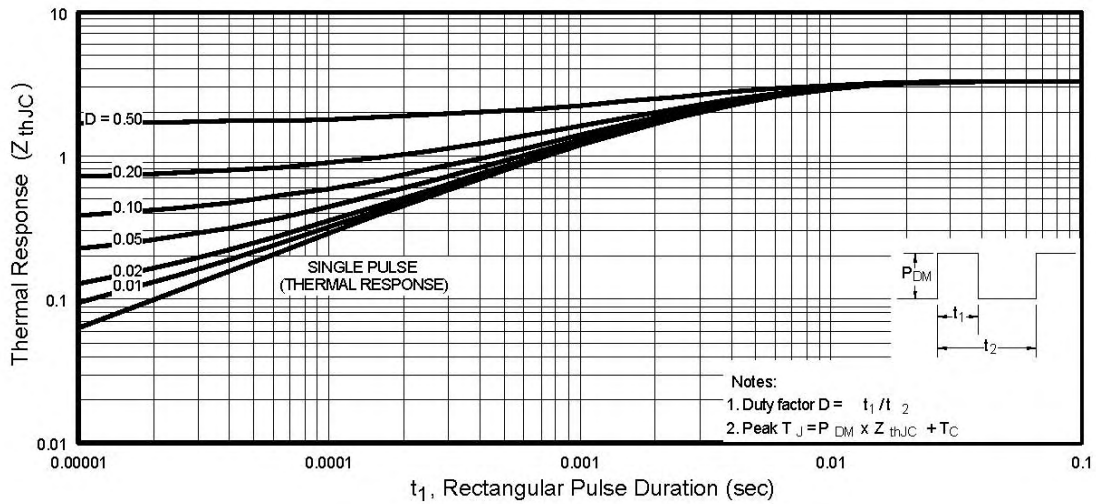
**Fig 9.** Maximum Drain Current Vs. Case Temperature



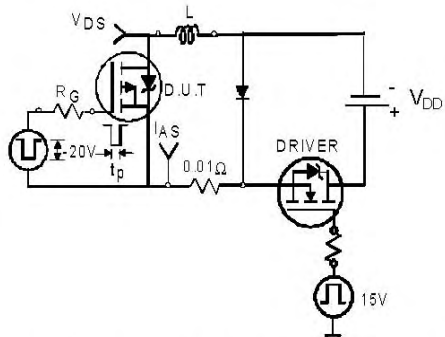
**Fig 10a.** Switching Time Test Circuit



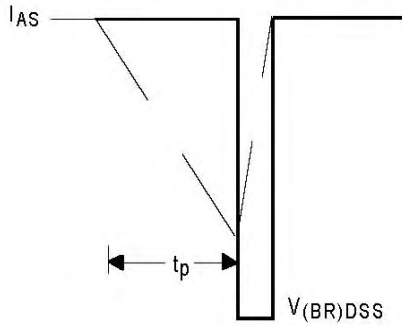
**Fig 10b.** Switching Time Waveforms



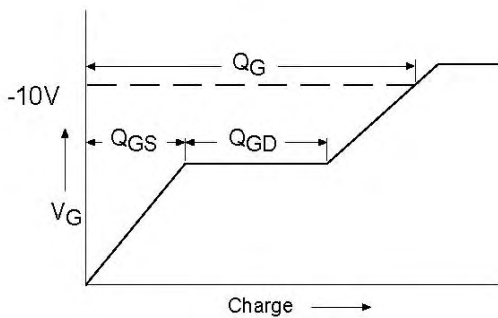
**Fig 11.** Maximum Effective Transient Thermal Impedance, Junction-to-Case



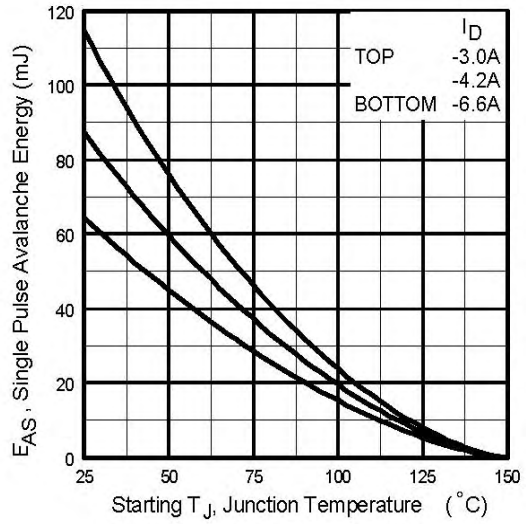
**Fig 12a.** Unclamped Inductive Test Circuit



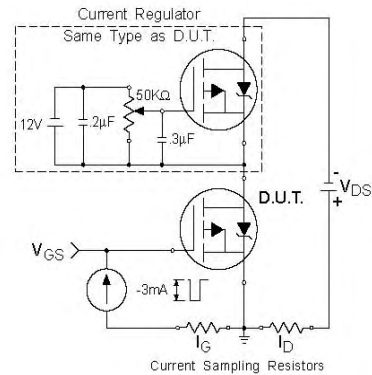
**Fig 12b.** Unclamped Inductive Waveforms



**Fig 13a.** Basic Gate Charge Waveform

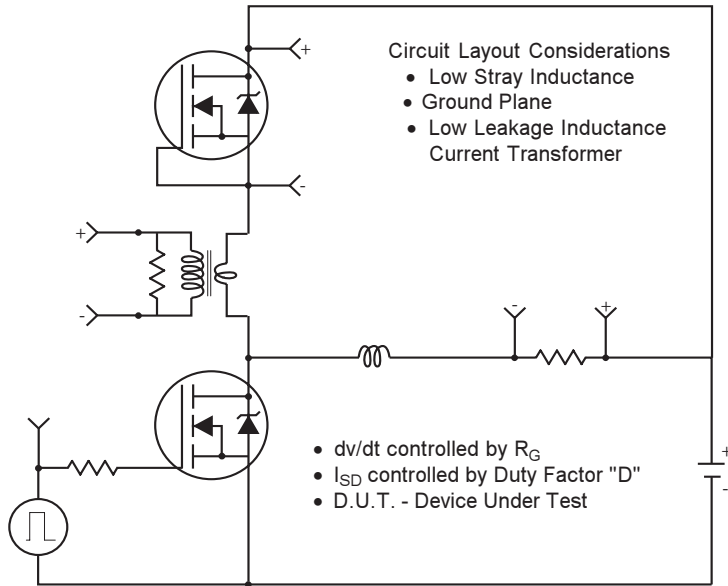


**Fig 12c.** Maximum Avalanche Energy Vs. Drain Current



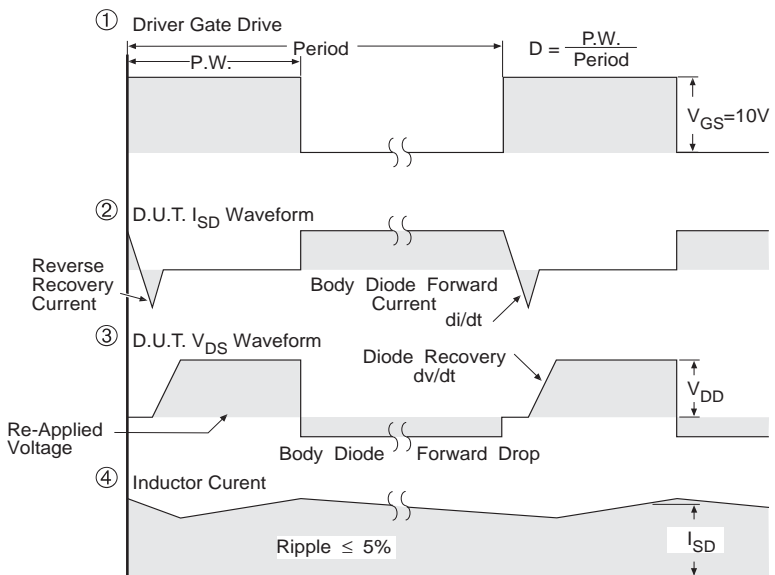
**Fig 13b.** Gate Charge Test Circuit

**Peak Diode Recovery dv/dt Test Circuit**



\* Reverse Polarity for P-Channel

\*\* Use P-Channel Driver for P-Channel Measurements



\*\*\*  $V_{GS} = 5.0V$  for Logic Level and 3V Drive Devices

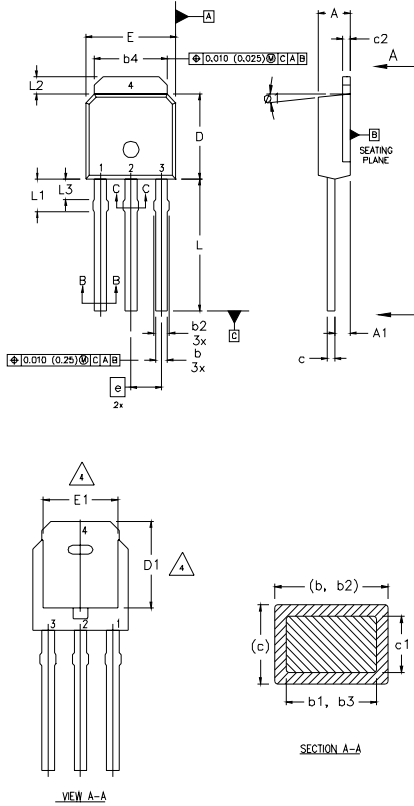
**Fig 14 For P Channel HEXFETS**





## I-Pak (TO-251AA) Package Outline

Dimensions are shown in millimeters (inches)



**NOTES:**

- 1 DIMENSIONING AND TOLERANCING PER ASME Y14.5 M- 1994.
- 2 DIMENSIONS ARE SHOWN IN MILLIMETERS [INCHES].
- 3 DIMENSION D & E DO NOT INCLUDE MOLD FLASH. MOLD FLASH SHALL NOT EXCEED 0.005" (0.127) PER SIDE. THESE DIMENSIONS ARE MEASURED AT THE OUTERMOST EXTREMES OF THE PLASTIC BODY.
- 4 THERMAL PAD CONTOUR OPTION WITHIN DIMENSION b4, L2, E1 & D1.
- 5 LEAD DIMENSION UNCONTROLLED IN L3.
- 6 DIMENSION b1, b3 APPLY TO BASE METAL ONLY.
- 7 OUTLINE CONFORMS TO JEDEC OUTLINE TO-251AA.
- 8 CONTROLLING DIMENSION : INCHES.

**LEAD ASSIGNMENTS**

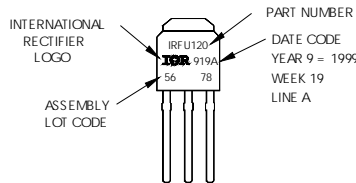
**HEXFET**

- 1.- GATE
- 2.- DRAIN
- 3.- SOURCE
- 4.- DRAIN

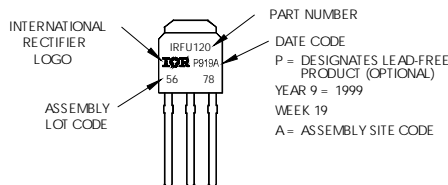
SYMBOL	DIMENSIONS				NOTES
	MILLIMETERS		INCHES		
	MIN.	MAX.	MIN.	MAX.	
A	2.18	2.39	0.086	.094	
A1	0.89	1.14	0.035	0.045	
b	0.64	0.89	0.025	0.035	
b1	0.64	0.79	0.025	0.031	4
b2	0.76	1.14	0.030	0.045	
b3	0.76	1.04	0.030	0.041	
b4	5.00	5.46	0.195	0.215	4
c	0.46	0.61	0.018	0.024	
c1	0.41	0.56	0.016	0.022	
c2	.046	0.86	0.018	0.035	
D	5.97	6.22	0.235	0.245	3, 4
D1	5.21	-	0.205	-	4
E	6.35	6.73	0.250	0.265	3, 4
E1	4.32	-	0.170	-	4
e	2.29		0.090 BSC		
L	8.89	9.60	0.350	0.380	
L1	1.91	2.29	0.075	0.090	
L2	0.89	1.27	0.035	0.050	4
L3	1.14	1.52	0.045	0.060	5
ø1	ø	15'	ø	15'	

## I-Pak (TO-251AA) Part Marking Information

EXAMPLE: THIS IS AN IRFU120 WITH ASSEMBLY LOT CODE 5678 ASSEMBLED ON WW 19, 1999 IN THE ASSEMBLY LINE "A"  
**Note:** "P" in assembly line position indicates "Lead-Free"



**OR**

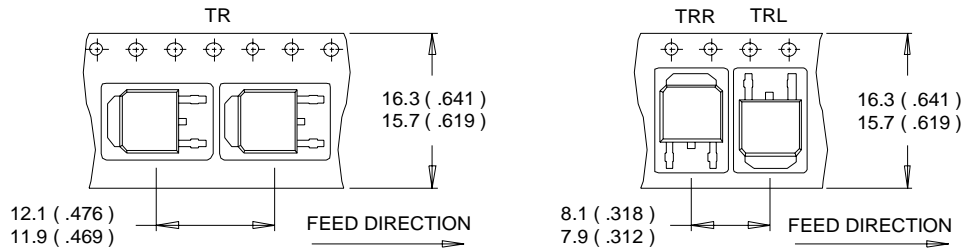


# IRFR/U9024NPbF

International  
**IR** Rectifier

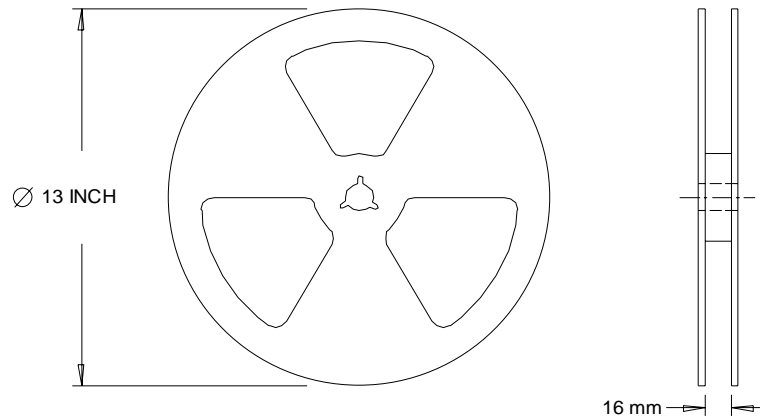
## D-Pak (TO-252AA) Tape & Reel Information

Dimensions are shown in millimeters (inches)



NOTES :

1. CONTROLLING DIMENSION : MILLIMETER.
2. ALL DIMENSIONS ARE SHOWN IN MILLIMETERS ( INCHES ).
3. OUTLINE CONFORMS TO EIA-481 & EIA-541.



NOTES :

1. OUTLINE CONFORMS TO EIA-481.

Data and specifications subject to change without notice.

International  
**IR** Rectifier

**IR WORLD HEADQUARTERS:** 233 Kansas St., El Segundo, California 90245, USA Tel: (310) 252-7105

TAC Fax: (310) 252-7903

Visit us at [www.irf.com](http://www.irf.com) for sales contact information.12/04

[www.irf.com](http://www.irf.com)

Note: For the most current drawings please refer to the IR website at:  
<http://www.irf.com/package/>

# Mouser Electronics

Authorized Distributor

Click to View Pricing, Inventory, Delivery & Lifecycle Information:

[Infineon:](#)

[IRFR9024NTRLPBF](#) [IRFU9024NPBF](#) [IRFR9024NPBF](#) [IRFR9024NTRPBF](#) [IRFR9024NTRRPBF](#)