

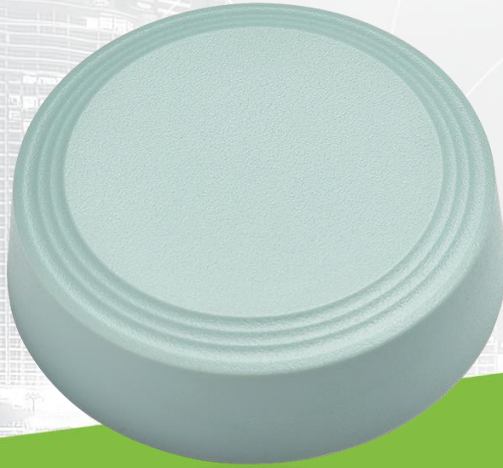

# TAOGLAS®



# Datasheet

## Direct Mount GPS L1 Active Antenna

**Part No:**  
A.60.3A21

### **Description:**

High Gain, High Rejection Active GPS Direct Mount Antenna

### **Features:**

30dB Gain

Rejection >60dB between 1 – 1000MHz  
>40dB between 2000 – 6000MHz

Permanent Mount

Wide Input Voltage Range (1.8V to 12V)

Low Profile Vandal Resistant PC/ABS Enclosure

IP67 Rated (When mounted), UV Stabilized Enclosure

Connector: MCX Female

Dimensions:  $\varnothing$ : 44.3mm and Height: 13mm

RoHS & Reach Compliant

1. Introduction	3
2. Specifications	4
3. Antenna Characteristics	6
4. LNA Specifications	9
5. 2D Radiation Patterns	10
6. 3D Radiation Patterns	12
7. Mechanical Drawing	13
8. Packaging	14
<hr/>	
Changelog	15

Taoglas makes no warranties based on the accuracy or completeness of the contents of this document and reserves the right to make changes to specifications and product descriptions at any time without notice. Taoglas reserves all rights to this document and the information contained herein. Reproduction, use or disclosure to third parties without express permission is strictly prohibited. Copyright © Taoglas Ltd.



# 1. Introduction

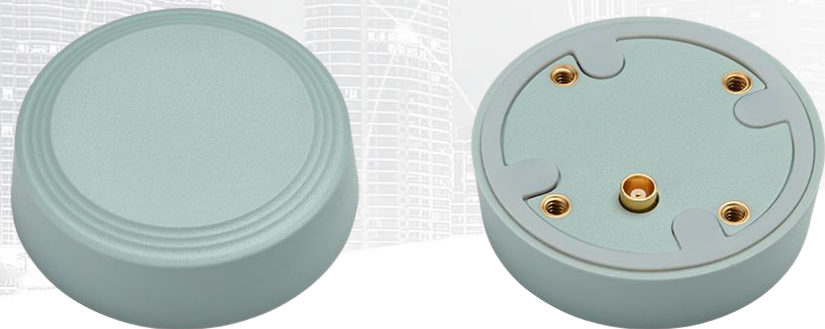

The Taoglas A.60 is a high-performance, high-rejection active GPS (L1 - 1575.42MHz), external permanent mount antenna. It has a high gain of 30dB all enclosed in a rugged PC/ABS enclosure with a diameter of just 44.3mm and an extremely low height of 13mm. The small size and direct mounting making it a perfect solution for small-cell timing applications used in close proximity to Wi-Fi and other cellular transmitters.

The integrated filters feature very good rejection across all non-GPS frequencies to prevent overdriving or damaging your GPS receiver from nearby transmitters. At the commonly used LTE frequencies between 700MHz-850MHz, the A.60 features greater than 60 dB of rejection. Between 1700MHz-1910MHz, approximately 50 dB of rejection. Even with the very good out of band rejection, the A.60 maintains a very low noise figure of 2.0 dB at 1575.42 MHz. This low noise figure minimizes the overall signal degradation typically caused by losses in transmission lines.

The enclosure is IP67 rated and when mounted, making it ideal for use in harsh, humid, and wet environments. The enclosure is made from durable UV resistant PC, weighing 28g (1oz), making it extremely light and economical for shipping. The A.60 antenna has high efficiency of 63% and a system gain of 31.18dB.

Typical applications include:

- Base Stations
- Connected Enterprise
- Navigation

The A.60 comes with a direct mount MCX female connector and 4 x 4-40 UNC screw holes for ease of installation. Contact your regional Taoglas Customer Support team for further information.

## 2. Specifications

GNSS Frequency Bands Covered						
GPS	L1	L2	L5			
	■	□	□			
GLONASS	G1	G2	G3			
	□	□	□			
Galileo	E1	E5a	E5b	E6		
	■	□	□	□		
BeiDou	B1	B2a	B2b	B3		
	□	□	□	□		
QZSS (Regional)	L1	L2C	L5	L6		
	■	□	□	□		
IRNSS (Regional)	L5					
	□					
SBAS	L1/E1/B1	L5/B2a/E5a	G1	G2	G3	
	■	□	□	□	□	

\*SBAS systems: WASS(L1/L5), EGNOS(E1/E5a), SDCM(G1/G2/G3), SNAS(B1,B2a), GAGAN(L1/L5), QZSS(L1/L5), KAZZ(L1/L5).

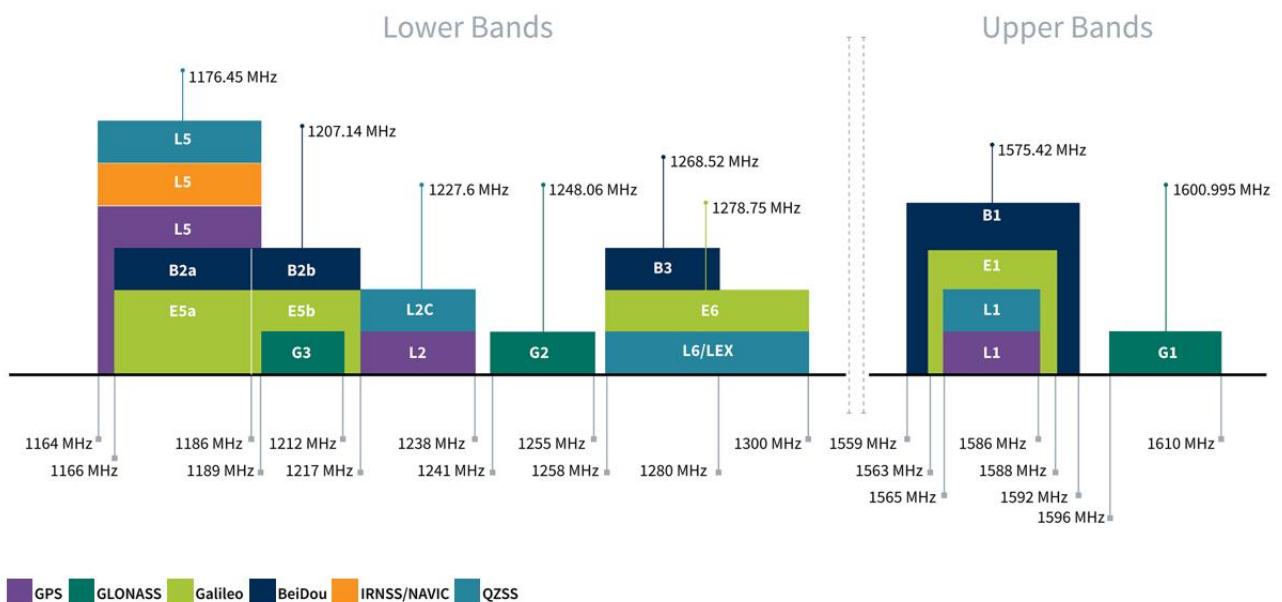

GNSS Bands and Constellations

Antenna Specification	
Center Frequency	1575.42 MHz $\pm$ 1.023 MHz
Efficiency	63.8%
Peak Gain(dBi)	1.18
Average Gain(dB)	-1.95
Axial Ratio (dB) at Zenith	1.69
Polarization	RHCP
Impedance	50 Ohms
LNA Specification	
Gain	31.18dB Typical
DC Power Input	+1.9 to +12V
Noise Figure	2.0 dB Typical
Power Consumption	<8 mA Typical
Out of Band Rejection	700-850MHz: >60dB 1700-1910MHz: >50dB
Input P1dB	-29 dBm
Mechanical	
Dimensions	Diameter: 44.3mm : Height: 13mm
Connector	MCX(F) Jack
Weight	26g(<1oz)
Mounting Type	Screw Mount
Enclosure Colour & Material	Federal Grey 26373 - PC/ABS
Environmental	
Storage Temp	-40 to +85C
Operating Temp	-40 to +85C

### 3. Antenna Characteristics

#### 3.1 Return Loss

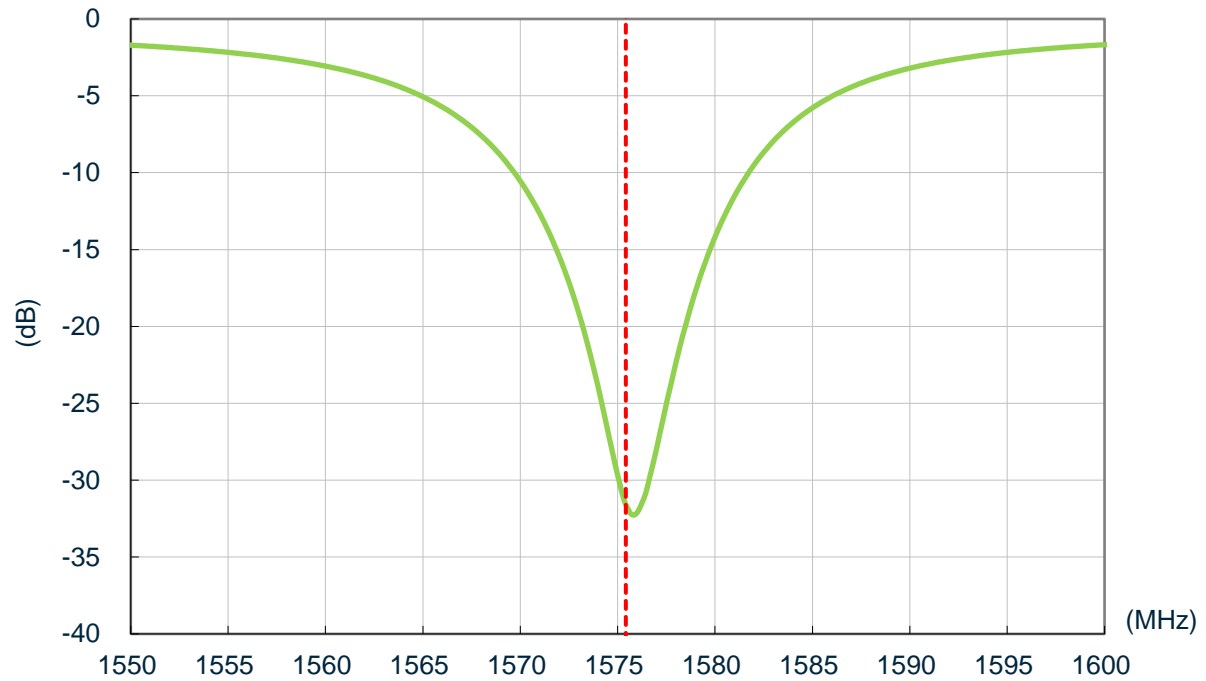

#### 3.2 Efficiency

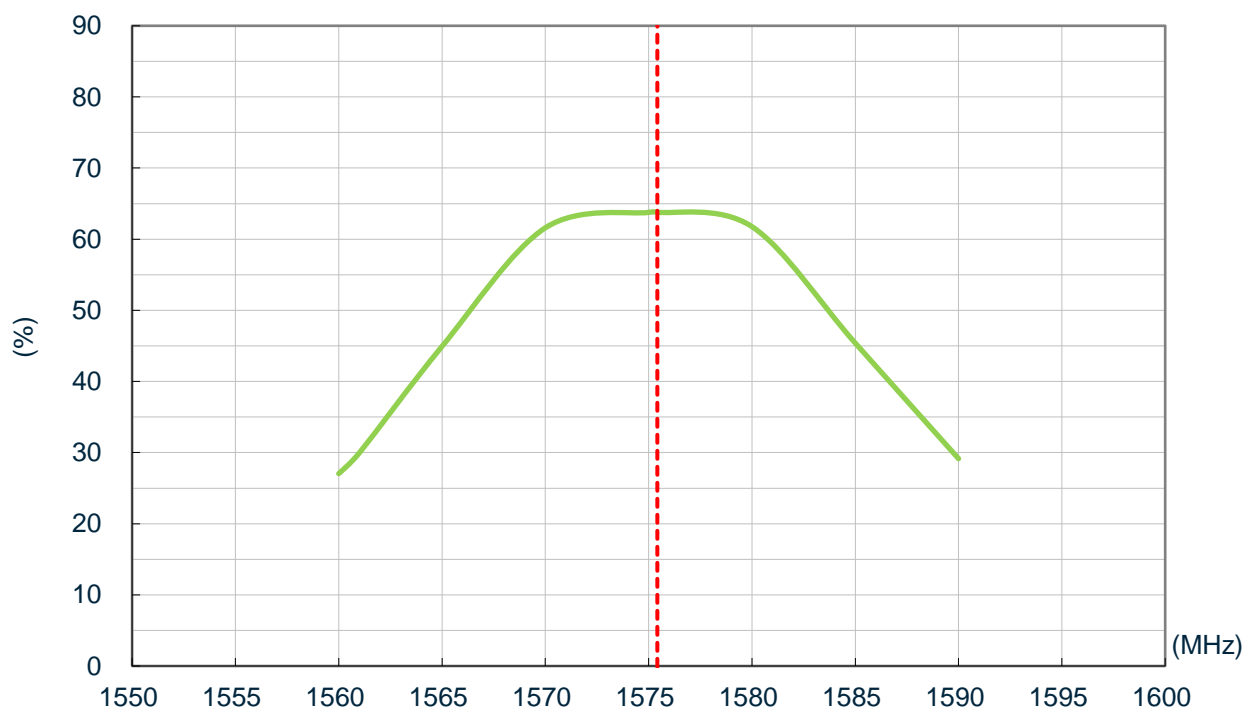

### 3.3 Average Gain

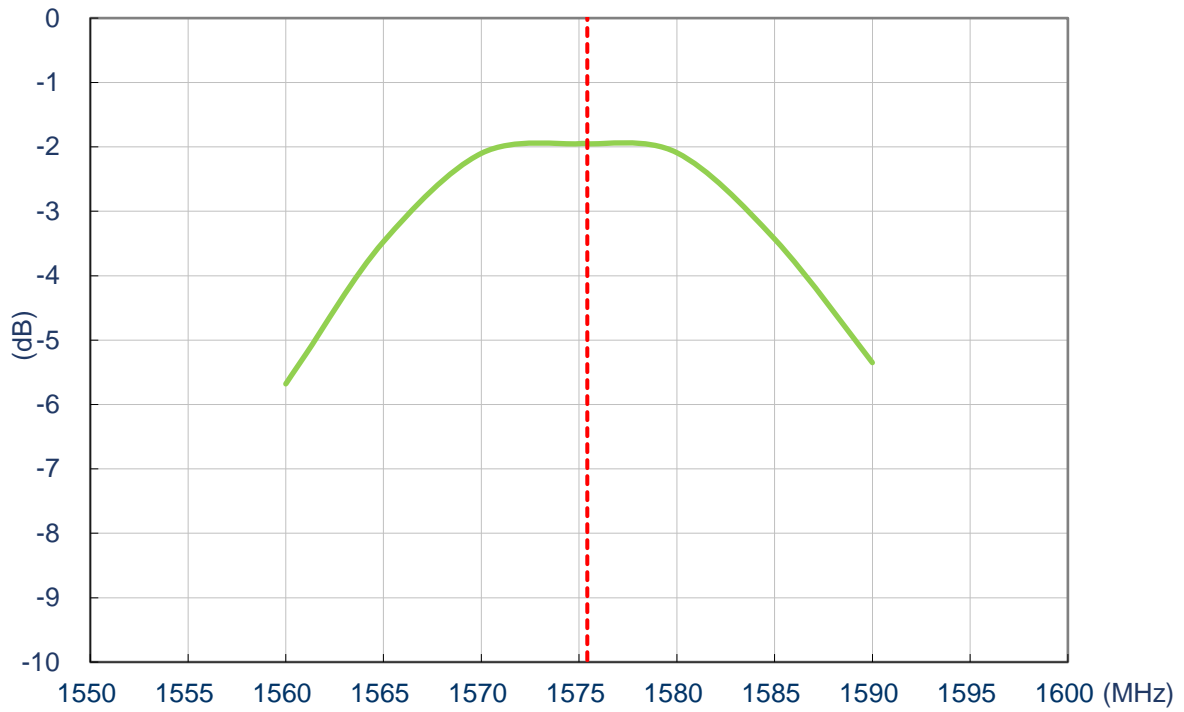

### 3.4 Peak Gain

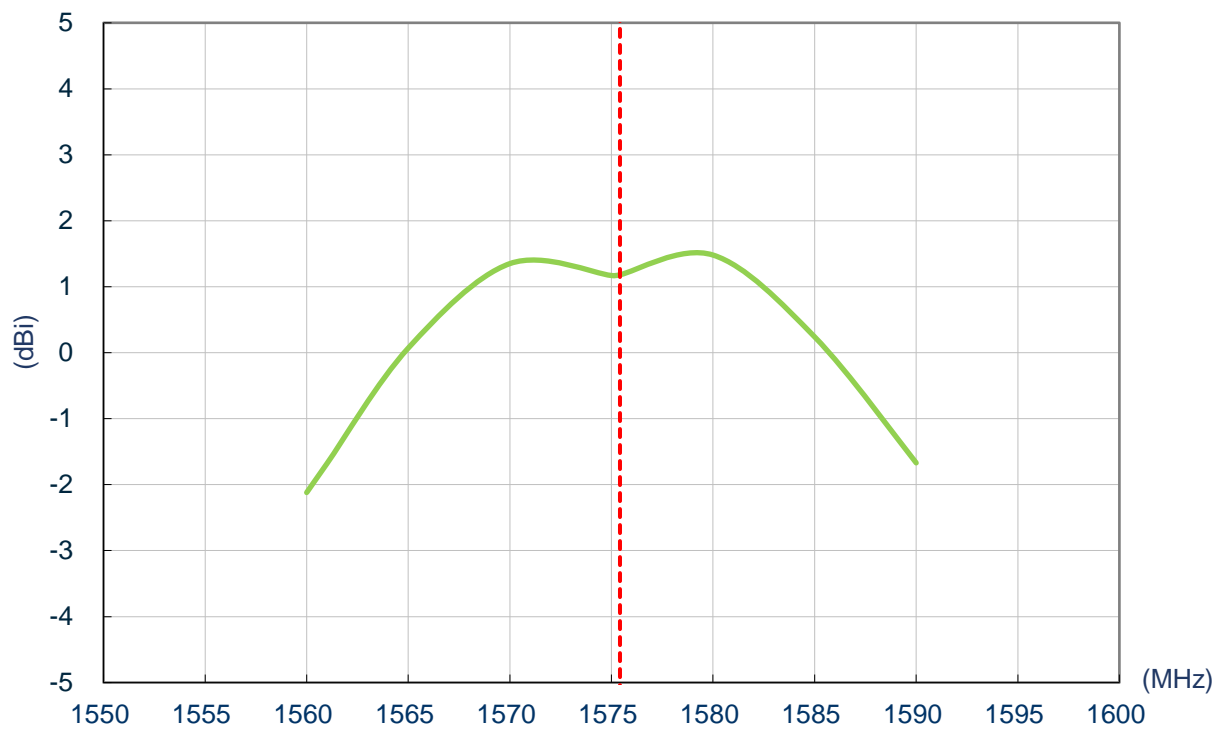

3.5 Axial Ratio

XZ Plane

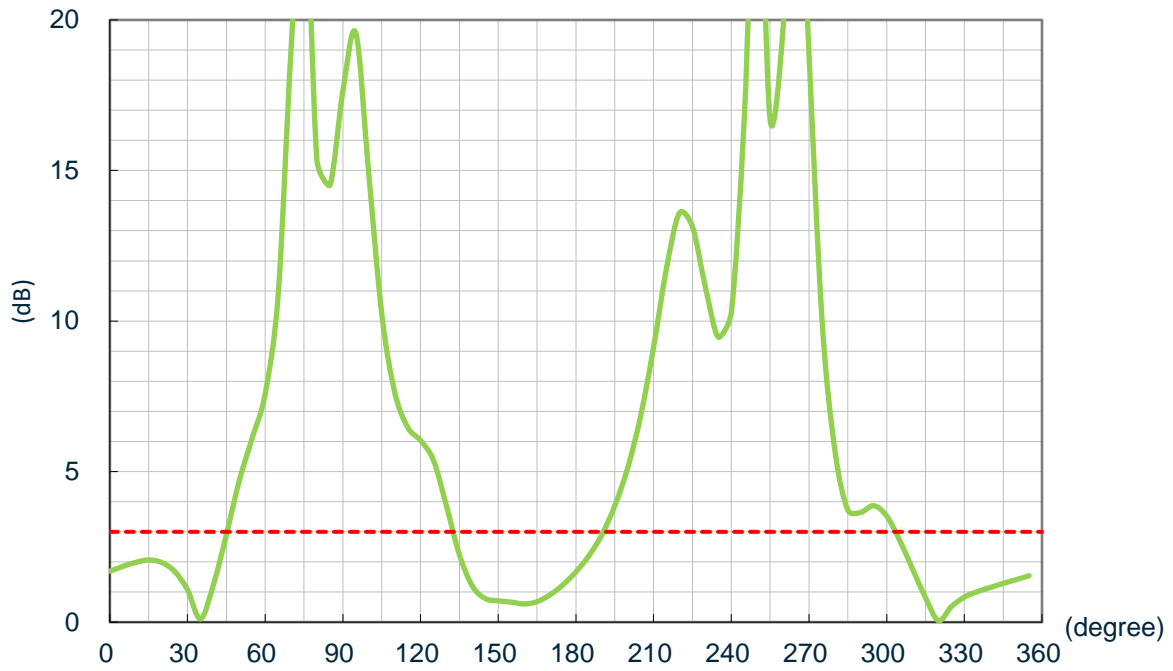

YZ Plane

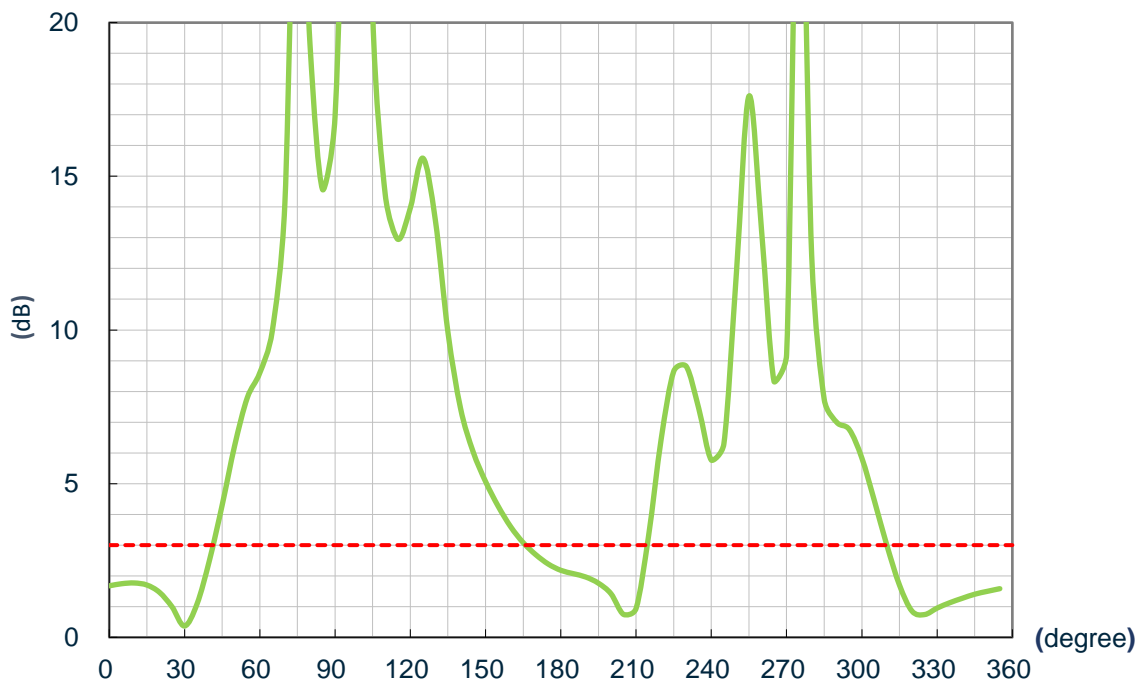



## 4. LNA Specifications

### 4.1 Narrowband LNA S21

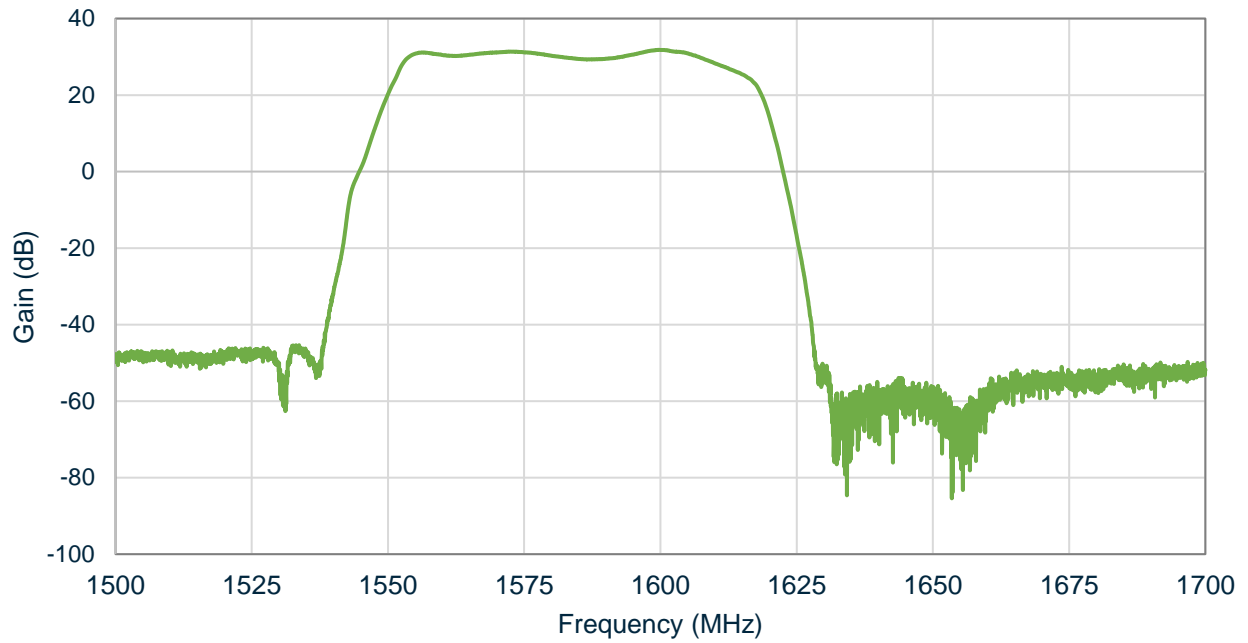

### 4.2 Wideband LNA S21

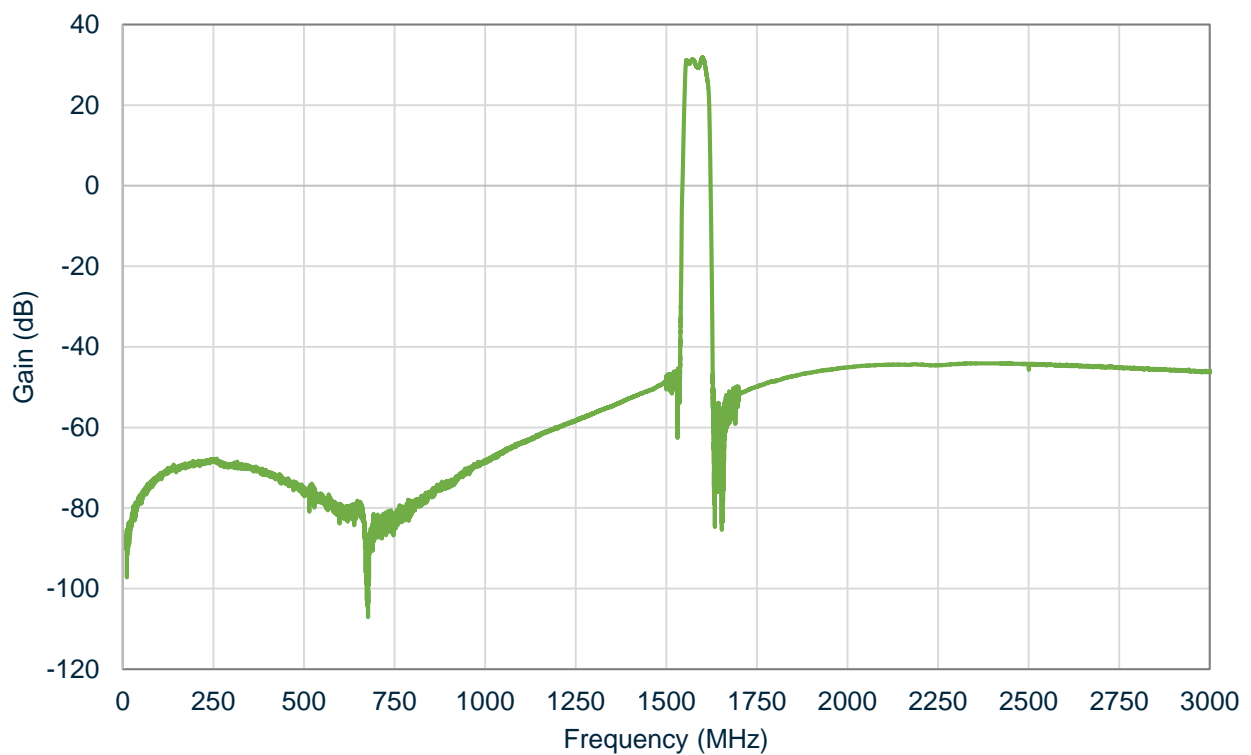

## 5. 2D Radiation Patterns

### 5.1 Test Setup

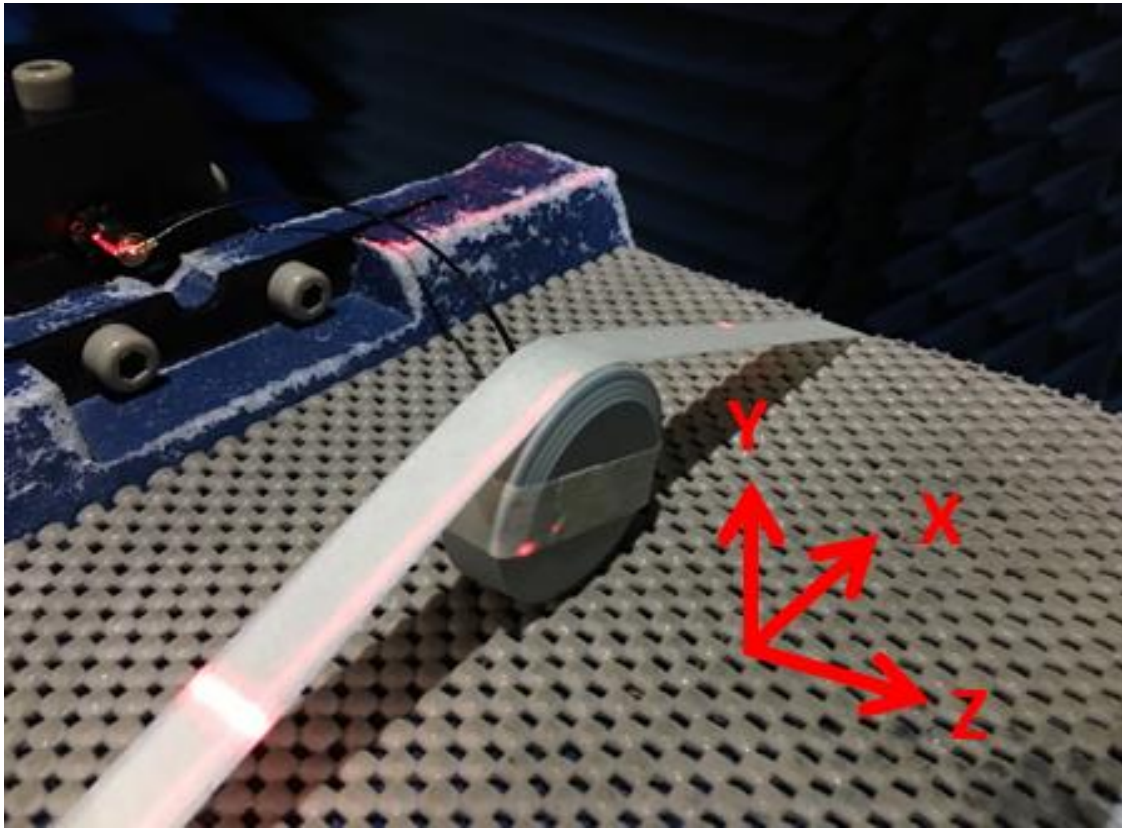

Free space

XY Plane

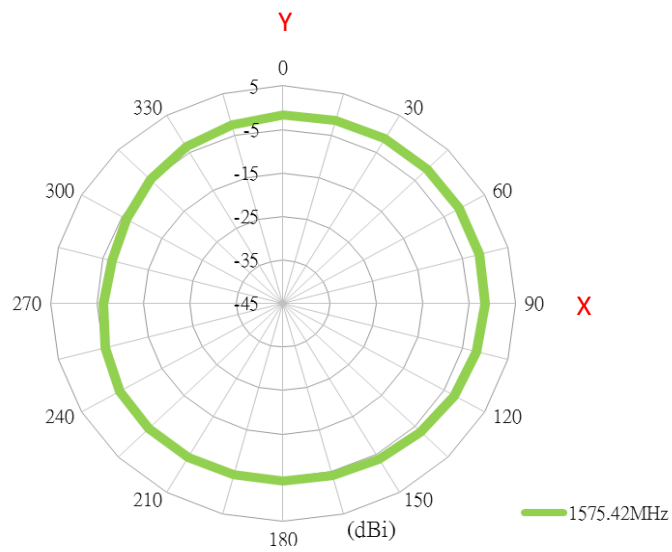

XZ Plane

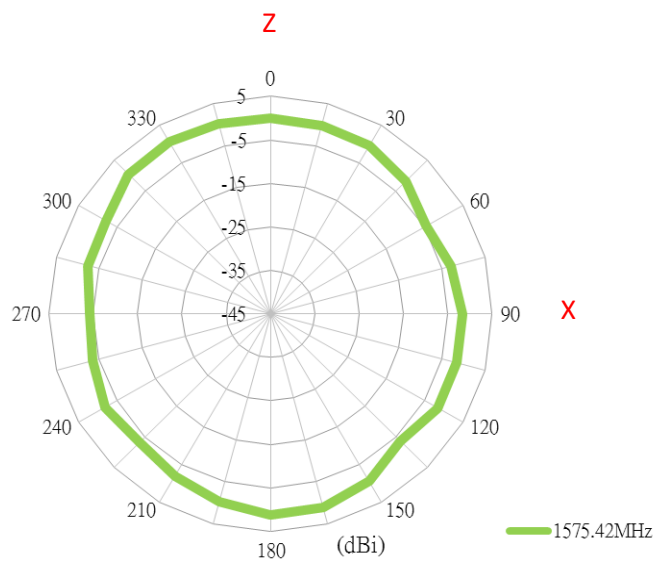

YZ Plane

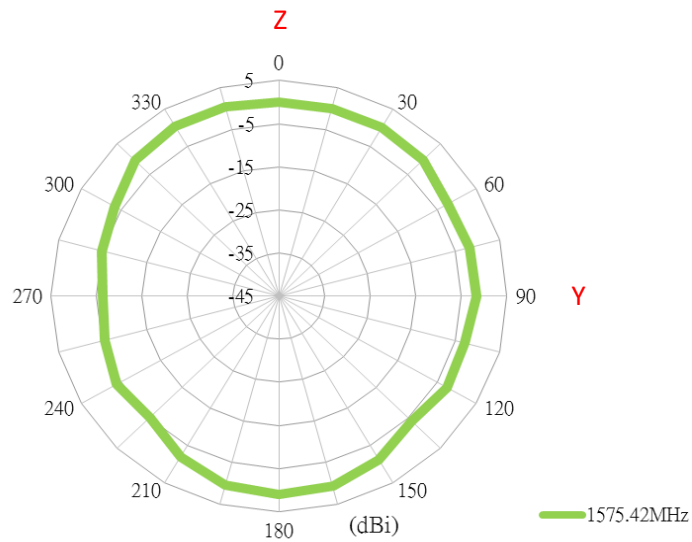

## 6. 3D Radiation Patterns

### 6.1 Free Space

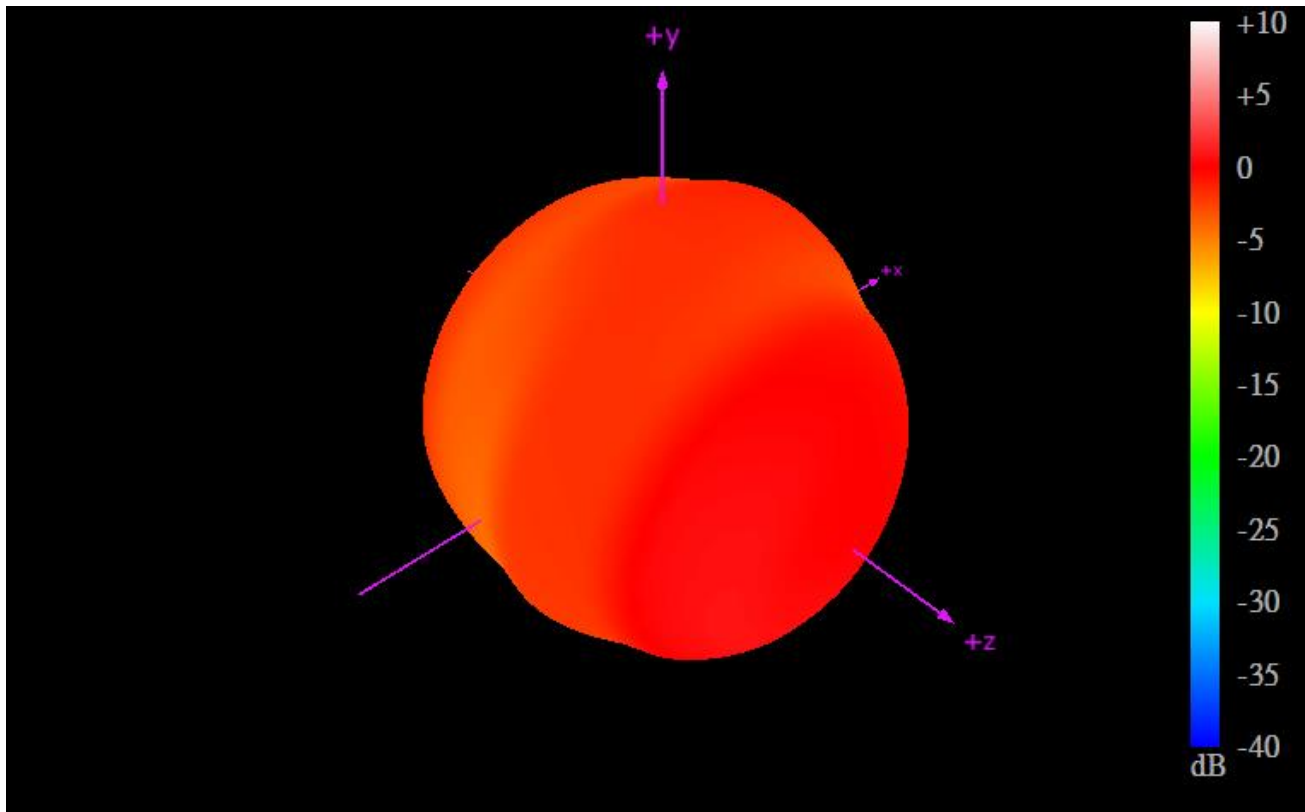

1575.42MHz

# 7. Mechanical Drawing (Units: mm)

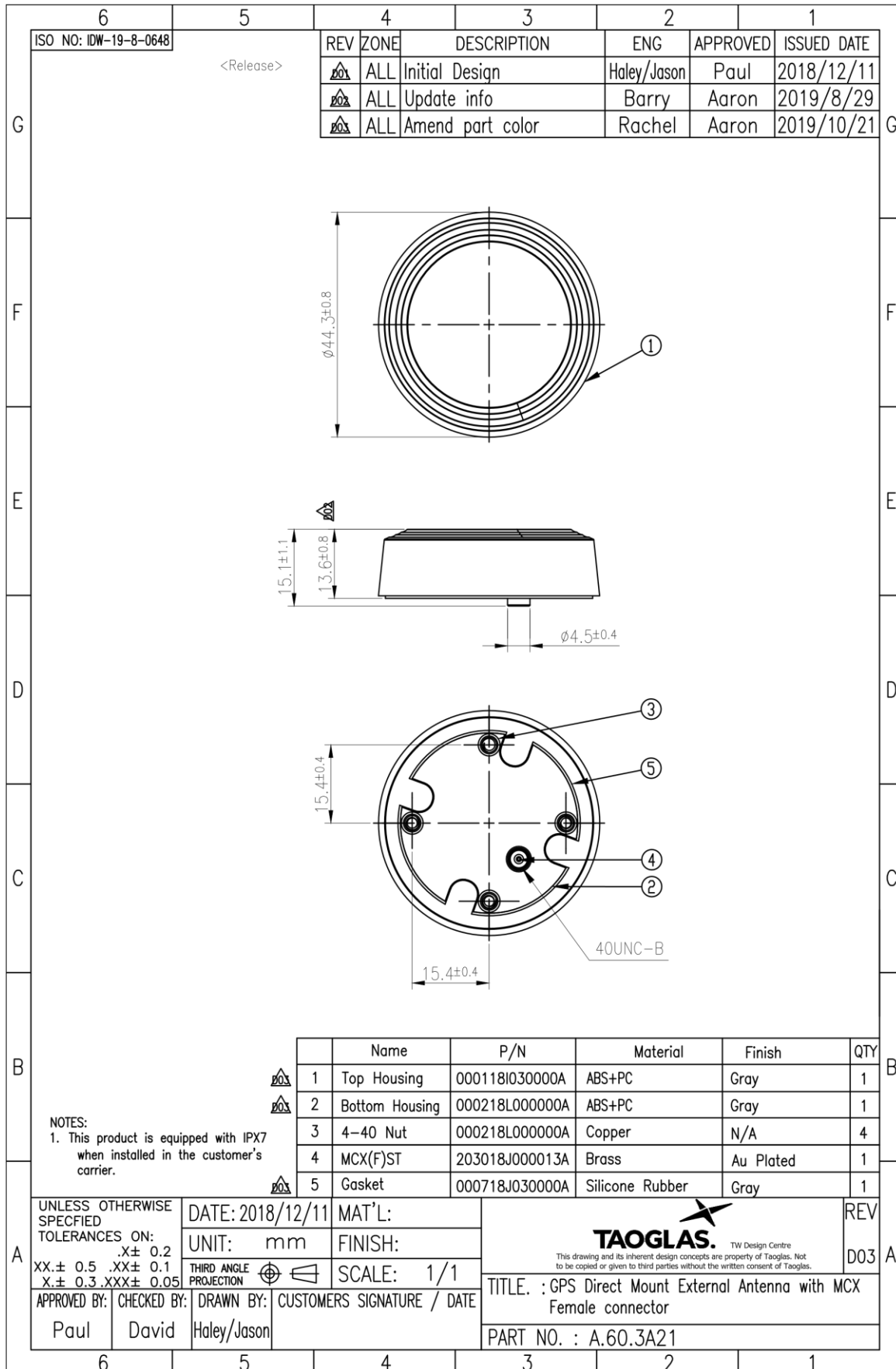

## 8. Packaging

18pcs A.60.3A21 per Package  
 Package Dimensions: 184\*165\*73mm  
 Weight: 0.59Kg

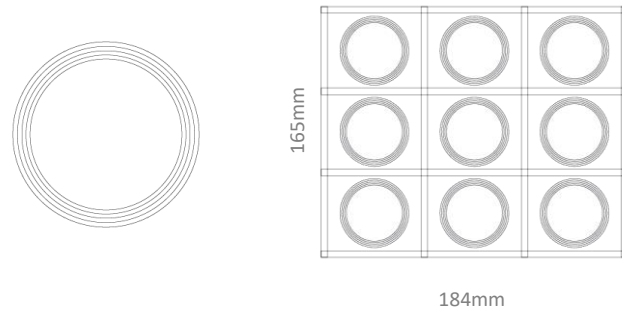

324pcs A.60.3A21 per carton  
 Dimensions: 600\*340\*245mm  
 Weight: 10.8Kg

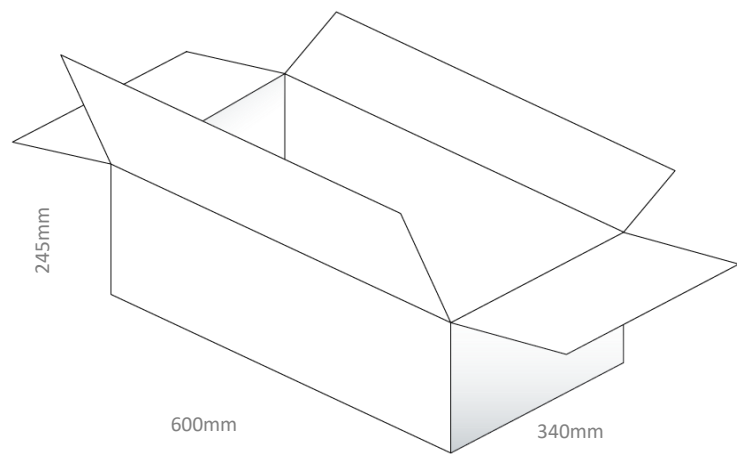

Changelog for the datasheet

**SPE-18-8-123 – A.60.3A21**

**Revision: B (Current Version)**

Date:	2020-11-05
Changes:	Updated Packaging and drawing
Changes Made by:	Jack Conroy

**Previous Revisions**

**Revision: A (Original First Release)**

Date:	2019-05-21
Notes:	Initial Draft Datasheet
Author:	Jack Conroy



**TAOGLAS**®

[www.taoglas.com](http://www.taoglas.com)

