

1825032-1 ✓ ACTIVE

[Alcoswitch](#) | [Alcoswitch SE](#)

TE Internal #: 1825032-1

Slide Switches, Single Pole - Double Throw Configuration (Pole-Throw), Vertical, Phosphor Bronze, Single Actuator, 2 Position, Alcoswitch SE

[View on TE.com >](#)



Relays, Contactors & Switches > Switches > Slide Switches



Configuration (Pole-Throw): **Single Pole - Double Throw**

Slide Switch Mounting Angle: **Vertical**

Contact Base Material: **Phosphor Bronze**

Number of Actuators: **Single**

Number of Slide Switch Positions: **2**

Features

Product Type Features

Threaded Case	Without
Grade	Instrumentation
Switch Type	Slide
Product Type	Switch
Switch Style	Process Sealed
Terminal Configuration	Standard
Actuator Style	Top

Configuration Features

Terminals Connected	1-2, 2-3
Process Seal Material	Silicone Rubber
Configuration (Pole-Throw)	Single Pole - Double Throw
Number of Actuators	Single
Number of Slide Switch Positions	2
Operating Function	On None On

Electrical Characteristics

Slide Switch Voltage Rating (VDC)	20
-----------------------------------	----

Body Features

Actuator Travel	2.2 mm[.087 in]
-----------------	-----------------



Actuator Material	PBT Basin
-------------------	-----------

Actuator Color	Yellow
----------------	--------

Contact Features

Contact Base Material	Phosphor Bronze
-----------------------	-----------------

Slide Switch Contact Current Rating	.4 A
-------------------------------------	------

Switch Contact Plating Material	Gold
---------------------------------	------

Termination Features

Termination Type	PC
------------------	----

Mechanical Attachment

PCB Mount Retention	With
---------------------	------

PCB Mount Retention Type	Extended
--------------------------	----------

Slide Switch Mounting Angle	Vertical
-----------------------------	----------

Slide Switch Mounting Type	Through Hole
----------------------------	--------------

Dimensions

PCB Tail Length	3.3 mm[.13 in]
-----------------	----------------

Actuator Length	2.8 mm[.11 in]
-----------------	----------------

Width	5 mm[.19 in]
-------	--------------

Length	9.5 mm[.37 in]
--------	----------------

Identification Marking

Stamped Marking	With
-----------------	------

Industry Standards

UL Flammability Rating	UL 94V-0
------------------------	----------

Product Compliance

[For compliance documentation, visit the product page on TE.com>](#)

EU RoHS Directive 2011/65/EU	Compliant
------------------------------	-----------

EU ELV Directive 2000/53/EC	Compliant
-----------------------------	-----------

China RoHS 2 Directive MIIT Order No 32, 2016	No Restricted Materials Above Threshold
---	---

EU REACH Regulation (EC) No. 1907/2006	Current ECHA Candidate List: JUNE 2022 (224) Candidate List Declared Against: JAN 2021 (211) Does not contain REACH SVHC
--	--

Halogen Content

Low Halogen - Br, Cl, F, I < 900 ppm per homogenous material. Also BFR/CFR/PVC Free

Solder Process Capability

Wave solder capable to 265°C

Product Compliance Disclaimer

This information is provided based on reasonable inquiry of our suppliers and represents our current actual knowledge based on the information they provided. This information is subject to change. The part numbers that TE has identified as EU RoHS compliant have a maximum concentration of 0.1% by weight in homogenous materials for lead, hexavalent chromium, mercury, PBB, PBDE, DBP, BBP, DEHP, DIBP, and 0.01% for cadmium, or qualify for an exemption to these limits as defined in the Annexes of Directive 2011/65/EU (RoHS2). Finished electrical and electronic equipment products will be CE marked as required by Directive 2011/65/EU. Components may not be CE marked. Additionally, the part numbers that TE has identified as EU ELV compliant have a maximum concentration of 0.1% by weight in homogenous materials for lead, hexavalent chromium, and mercury, and 0.01% for cadmium, or qualify for an exemption to these limits as defined in the Annexes of Directive 2000/53/EC (ELV). Regarding the REACH Regulation, the information TE provides on SVHC in articles for this part number is based on the latest European Chemicals Agency (ECHA) 'Guidance on requirements for substances in articles' posted at this URL: <https://echa.europa.eu/guidance-documents/guidance-on-reach>

Compatible Parts



TE Part # 1825032-2
SE1EGPC04=SEALED SLIDE SWITCH



TE Part # 1825032-3
SE2DGPC04=SEALED SLIDE SWITCH

Also in the Series | Alcoswitch SE



Printable Tubing(3)



RJ14 Connectors(4)



RJ22 Connectors(2)



RJ25 Connectors(5)



RJ45 Connectors(9)



Slide Switches(5)

Customers Also Bought

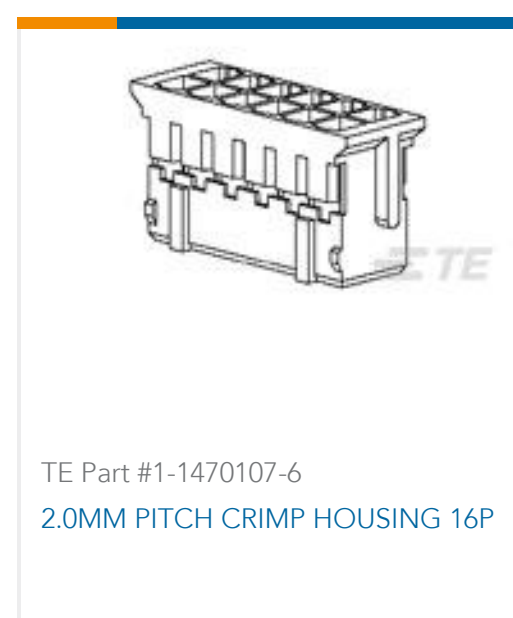
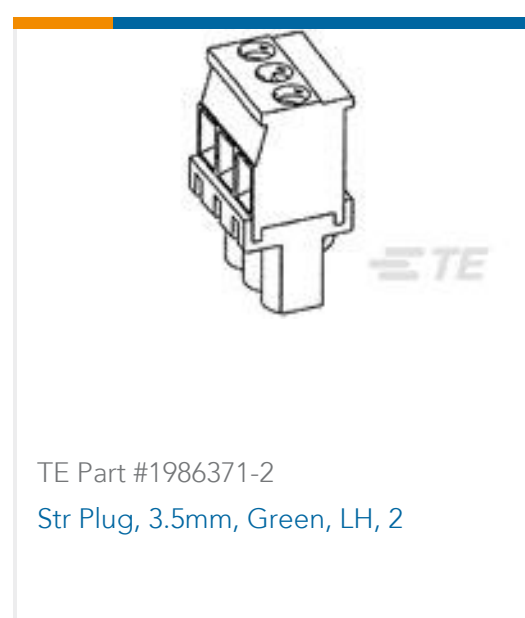
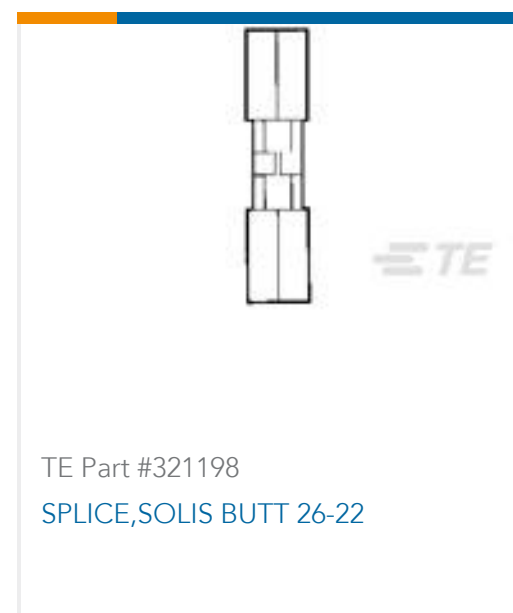

Documents

Product Drawings

[SE1DGPC04=SEALED SLIDE SWITCH](#)

English

CAD Files

Customer View Model

[ENG_CVM_CVM_1825032-1_B.3d_igs.zip](#)

English

Customer View Model

[ENG_CVM_CVM_1825032-1_B.3d_stp.zip](#)

English

Customer View Model

[ENG_CVM_CVM_1825032-1_B.2d_dxf.zip](#)

English

3D PDF

3D

By downloading the CAD file I accept and agree to the [Terms and Conditions](#) of use.



Datasheets & Catalog Pages

[SWITCHES_CORE_PROGRAM_CATALOG](#)

English

Product Environmental Compliance

[TE Material Declaration](#)

English