



Data Sheet

RELEASE 0



GRF5507

High Linearity Power Amplifier 0.7 to 0.8 GHz

FEATURES

- Excellent OP1dB, OIP3, ACLR and IM3 Performance
- Native Linearity Provides up to +24.5 dBm P_{OUT} with > 45dBc ACLR – Without the Need for Digital Predistortion Correction
- +24dBm Linear Output Power Maintained at 85 °C
- Flexible Biasing Provides Latitude for Linearity Optimization
- 195 mA Native Mode Quiescent Current Consumption
- 5 V Supply Voltage
- 50Ω Single-ended Input and Output Impedances
- Digital Shutdown
- Rugged Design is Extremely Resilient to Mismatched Loads
- -40 to 85 °C Operating Temperature Range
- Compact 3 x 3 mm QFN-16 Package

Reference: 5.0V/750MHz/195mA I_{CCQ}

- Gain: 30.5 dB
- OIP3: 47.3 dBm @ +23 dBm P_{OUT}/tone
- OP1dB: 33.4 dBm
- Noise Figure: 4.5 dB

APPLICATIONS

- Cellular Boosters/Repeaters
- Automotive Compensators
- Picocells/Femtocells
- Cellular DAS
- Customer Premise Equipment
- Wireless Infrastructure

DESCRIPTION

The GRF5507 is a high gain, two-stage InGaP HBT power amplifier designed to deliver excellent P1dB, ACLR and IM3 performance over the 700 to 800 MHz band. Its exceptional native linearity makes it an ideal choice for transmitter applications that typically do not employ digital predistortion correction schemes.

This device is part of a complete family of externally matched linear amplifiers that cover the following frequency ranges:

GRF5506: 0.66 - 0.72 GHz	GRF5518: 1.8 - 1.91 GHz
GRF5507: 0.7 - 0.8 GHz	GRF5519: 1.92 - 2.0 GHz
GRF5508: 0.8 - 0.9 GHz	GRF5521: 2.11 - 2.17 GHz
GRF5510: 0.88 - 0.96 GHz	GRF5526: 2.5 - 2.7 GHz
GRF5517: 1.7 - 1.8 GHz	GRF5536: 3.4 – 3.8 GHz

Please consult with the GRF applications engineering team for custom tuning/evaluation board data.

BLOCK DIAGRAM

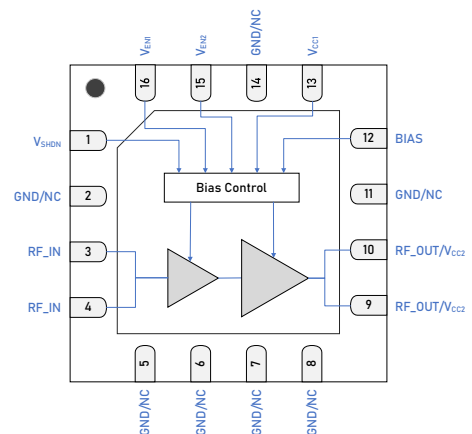

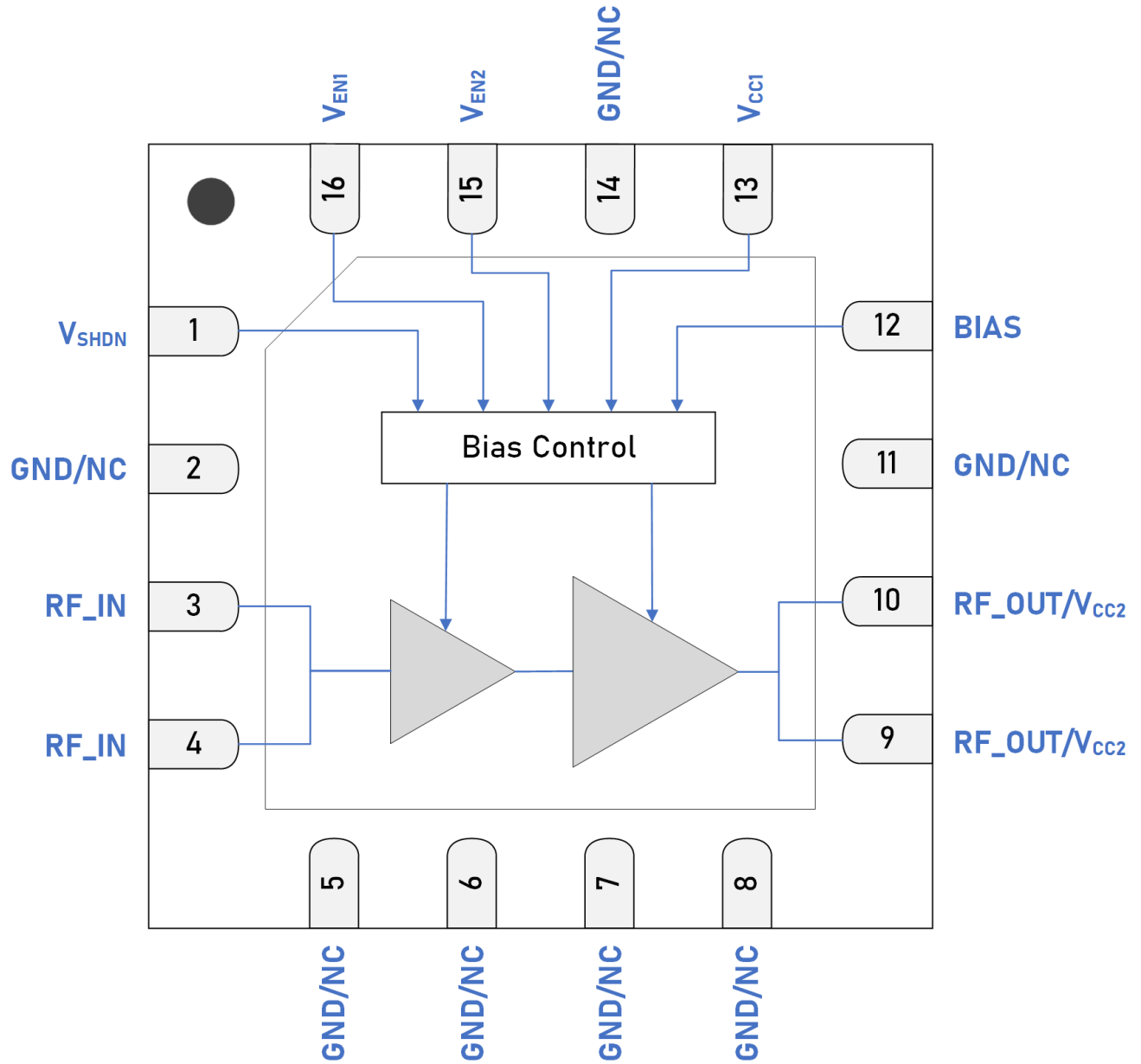

3 x 3mm QFN-16 Pin Out (Top View)

Pin Assignments

Pin	Name	Description	Note
1	V _{SHDN}	Digital Shutdown Pin	V _{SHDN} ≥ 1.7 V (Logic HIGH) disables device. V _{SHDN} ≤ 0.9 V (Logic LOW) enables device.
2, 5-8, 11, 14	GND/NC	Ground or No Connect	No internal connection to die. These pins can be left unconnected, or be connected to ground (recommended). Use a via as close to the pin as possible if grounded.
3-4	RF_IN	RF Input	Internally matched 50 Ω. An external DC blocking cap must be used. Pins 3-4 tied together on system board.
9-10	RF_OUT/V _{CC2}	PA Output/Bias Voltage	Pins 9-10 tied together on system board. V _{CC2} must be applied to this pin via an RF choke.
12	Bias	Bias Circuit Supply	Connect to V _{CC2} through external resistor.
13	V _{CC1}	Bias Voltage	Connect to V _{CC1} through external resistor.
15	V _{EN2}	Enable2 Voltage Input	V _{EN2} and series resistor set I _{CCQ} for the output stage. V _{EN2} ≤ 0.2 volts disables stage 2.
16	V _{EN1}	Enable1 Voltage Input	V _{EN1} and series resistor set I _{CCQ} for the input stage. V _{EN1} ≤ 0.2 volts disables stage 1. Connecting an external de-coupling capacitor to ground is required for optimal NF performance.
PKG BASE	GND	Ground	Provides DC and RF ground for the amplifier, as well as thermal heat sink. Recommend multiple 8 mil vias beneath the package for optimal RF and thermal performance. Refer to evaluation board top layer graphic on schematic page.

Absolute Ratings

Parameter		Symbol	Min.	Max.	Unit
Supply Voltage		V_{CC}		5.5	V
RF Input Power	(50 Ω , V_{CC} = 5.0 V, CW Tone, 100% DC, $T_{PKG\ HEAT\ SINK}$ = 25°C)	$P_{IN\ MAX - 1:1}$		13	dBm
	(Load VSWR \leq 8:1, all phase angles, V_{CC} = 5.0 V, CW Tone, 100% DC, $T_{PKG\ HEAT\ SINK}$ = -40 to 85°C)	$P_{IN\ MAX - 8:1}$		6	
Operating Temperature (Package Heat Sink)		$T_{PKG\ HEAT\ SINK}$	-40	85	°C
Maximum Junction Temperature (MTTF > 10 ⁶ Hours)		$T_{J\ MAX}$		170	°C
Maximum Dissipated Power (Stage 1)		$P_{DISS\ MAX}$		500	mW
Maximum Dissipated Power (Stage 2)		$P_{DISS\ MAX}$		850	mW

Electrostatic Discharge

Charged Device Model	CDM	1000		V
Human Body Model	HBM	500		V

Storage

Storage Temperature	T_{STG}	-65	150	°C
Moisture Sensitivity Level	MSL		1	–



Caution! ESD Sensitive Device

Exceeding Absolute Maximum Rating conditions may cause permanent damage to the device.

Note: For additional information, please refer to *Manufacturing Note MN-001 — Package and Manufacturing Information*.



All Guerrilla RF products are provided in RoHS compliant lead (Pb)-free packaging. For additional information, please refer to the *Certificate of RoHS Compliance*.

Recommended Operating Conditions

Parameter	Symbol	Specification			Unit	Condition
		Min.	Typ.	Max.		
Power Supply Voltage	V_{CC}	3	5	5.5	V	
Operating Temperature (Package Heat Sink)	$T_{PKG \text{ HEAT SINK}}$	-40		85	°C	
RF Frequency Range	F_{RF}	0.7		0.8	GHz	Typical Application Schematic Using the 0.7 to 0.8 GHz Tuning Set (Note 1)
RFIN Port Impedance	Z_{RFIN}		50		Ω	Single Ended, with 2-element Match
RFOUT Port Impedance	Z_{RFOUT}		50		Ω	Single Ended, with 3-element Match

Note 1: Operation outside this range is possible, but with degraded performance of some parameters.

Nominal Operating Parameters - General

The following conditions apply unless noted otherwise: Typical Application Schematic using the 0.7 to 0.8 GHz tuning set, $M5 = 1.7\text{ k}\Omega$, $M9 = 3.3\text{ k}\Omega$, $V_{\text{SHDN}} = \text{LOW}$, $V_{\text{CC}} = +4.75\text{ to }+5.25\text{ V}$, $I_{\text{CCQ}} = 195\text{ mA}$, $50\ \Omega$ system impedance, $P_{\text{OUT}} = +23\text{ dBm}$, $F_{\text{TEST}} = 0.7\text{ to }0.8\text{ GHz}$, $T_{\text{PKG HEAT SINK}} = -40\text{ to }+85\text{ }^\circ\text{C}$. Typical values are at $V_{\text{CC}} = +5.0\text{ V}$, $I_{\text{CCQ}} = 195\text{ mA}$, $P_{\text{OUT}} = +23\text{ dBm}$, $F_{\text{TEST}} = 0.75\text{ GHz}$, $T_{\text{PKG HEAT SINK}} = 25\text{ }^\circ\text{C}$. MIN/MAX specifications listed in italics are guaranteed via production test screening. All other parameters are guaranteed by design and characterization. Evaluation board losses are included within the specifications.

Parameter	Symbol	Specification			Unit	Condition
		Min.	Typ.	Max.		
Supply Quiescent Current	I_{CCQ}		195		mA	$I_{\text{CCQ1}} + I_{\text{CCQ2}}$. No RF Applied.
Supply Current with RF Applied	I_{CC}		305		mA	$I_{\text{CC1}} + I_{\text{CC2}}$. RF Applied with $P_{\text{OUT}} = 23\text{ dBm}$.
Enable Current 1	I_{ENABLE1}		2.3		mA	$V_{\text{CC}} = 5\text{ V}$, $T_{\text{PKG HEAT SINK}} = 25\text{ }^\circ\text{C}$
Enable Current 2	I_{ENABLE2}		0.65		mA	$V_{\text{CC}} = 5\text{ V}$, $T_{\text{PKG HEAT SINK}} = 25\text{ }^\circ\text{C}$
Operating Temperature Range	$T_{\text{PKG HEAT SINK}}$	-40		+85	$^\circ\text{C}$	Measured on Package Heat Sink
Logic Input Low	V_{IL}	0		0.9	V	Applies to V_{SHDN} Input
Logic Input High	V_{IH}	1.7		V_{CC}	V	Applies to V_{SHDN} Input
Logic Current Low	I_{IL}		3		nA	Applies to V_{SHDN} Input, $V_{\text{IL}} = 0.9\text{ V}$.
Logic Current High	I_{IH}		60		μA	Applies to V_{SHDN} Input, $V_{\text{IH}} = 1.8\text{ V}$.
			280			Applies to V_{SHDN} Input, $V_{\text{IH}} = 3.3\text{ V}$.
Switching Rise Time	T_{RISE}		500		ns	Applies to V_{SHDN} Input
Switching Fall Time	T_{FALL}		2800		ns	Applies to V_{SHDN} Input

Disabled Mode

Supply Quiescent Current	$I_{\text{CCQ-SHDN}}$		1		μA	$V_{\text{CC}}: 5.0\text{ V}$; $V_{\text{SHDN}} = \text{HIGH}$
Enable Current 1	$I_{\text{ENABLE1-SHDN}}$		3		mA	$V_{\text{CC}}: 5.0\text{ V}$; $V_{\text{SHDN}} = \text{HIGH}$
Enable Current 2	$I_{\text{ENABLE2-SHDN}}$		1.3		mA	$V_{\text{CC}}: 5.0\text{ V}$; $V_{\text{SHDN}} = \text{HIGH}$

Thermal Data (Stage 1)

Thermal Resistance (Infrared Scan)	Θ_{JC}		163		$^\circ\text{C/W}$	On Standard Evaluation Board. No RF.
------------------------------------	----------------------	--	-----	--	--------------------	--------------------------------------

Thermal Data (Stage 2)

Thermal Resistance (Infrared Scan)	Θ_{JC}		98		$^\circ\text{C/W}$	On Standard Evaluation Board. No RF.
------------------------------------	----------------------	--	----	--	--------------------	--------------------------------------

Nominal Operating Parameters - RF (0.7 to 0.8 GHz, 5V Operation)

The following conditions apply unless noted otherwise: Typical Application Schematic using the 0.7 to 0.8 GHz tuning set, $M5 = 1.7\text{ k}\Omega$, $M9 = 3.3\text{ k}\Omega$, $V_{SHDN} = \text{LOW}$, $V_{CC} = +4.75\text{ to }+5.25\text{ V}$, $I_{CCQ} = 195\text{ mA}$, $50\ \Omega$ system impedance, $P_{OUT} = +23\text{ dBm}$, $F_{TEST} = 0.7\text{ to }0.8\text{ GHz}$, $T_{PKG\ HEAT\ SINK} = -40\text{ to }+85\text{ }^\circ\text{C}$. Typical values are at $V_{CC} = +5.0\text{ V}$, $I_{CCQ} = 195\text{ mA}$, $P_{OUT} = +23\text{ dBm}$, $F_{TEST} = 0.75\text{ GHz}$, $T_{PKG\ HEAT\ SINK} = 25\text{ }^\circ\text{C}$. MIN/MAX specifications listed in italics are guaranteed via production test screening. All other parameters are guaranteed by design and characterization. Evaluation board losses are included within the specifications.

Parameter	Symbol	Specification			Unit	Condition
		Min.	Typ.	Max.		
Small Signal Gain	S21	28.5 (Note 2)	30.5		dB	LTE 20MHz 100RB TM1.1 Downlink Waveform with 9.8dB PAR, $F_{TEST} = 0.75\text{ GHz}$, $T_{PKG\ HEAT\ SINK} = 25\text{ }^\circ\text{C}$, $V_{CC} = 5\text{ V}$, $P_{IN} = -25\text{ dBm}$.
Standby Mode Gain	S21 _{STBY}		-45		dB	Disabled Mode, LTE 20MHz 100RB TM1.1 Downlink Waveform with 9.8dB PAR, $V_{SHDN} = \text{HIGH}$, $P_{IN} = 0\text{ dBm}$.
Input Return Loss	S11		> 11.3		dB	$F_{RF} = 0.7\text{ to }0.8\text{ GHz}$
Output Return Loss	S22		> 4.8		dB	$F_{RF} = 0.7\text{ to }0.8\text{ GHz}$
Reverse Isolation	S12		> 51		dB	$F_{RF} = 0.7\text{ to }0.8\text{ GHz}$
Evaluation Board Noise Figure	NF		4.5		dB	
Output 3rd Order Intercept	OIP3		47.3		dBm	+23 dBm P_{OUT} per Tone at 600 kHz Spacing
Output 1 dB Compression Power	OP1dB	31.9 (Note 2)	33.4		dBm	Sine wave input, $V_{CC} = 5\text{ V}$, $T_{PKG\ HEAT\ SINK} = 25\text{ }^\circ\text{C}$
Adjacent Channel Leakage Ratio	ACLR			-45	dBc	$P_{OUT} = +23\text{ dBm}$, LTE 20MHz 100RB TM1.1 Downlink Waveform with 9.8dB PAR, $F_{TEST} = 0.75\text{ GHz}$, $T_{PKG\ HEAT\ SINK} = 25\text{ }^\circ\text{C}$, $V_{CC} = 5\text{ V}$.

Note 2: MIN/MAX limits defined using *modelled estimates* that account for part-to-part variations and expected process spreads. As additional production lots are fabricated, accumulated test data will be used to refine the MIN/MAX limits.

Typical Operating Curve Conditions

The following conditions apply unless noted otherwise: Typical Application Schematic using the 0.7 to 0.8 GHz tuning set, $M5 = 1.7\text{ k}\Omega$, $M9 = 3.3\text{ k}\Omega$, $V_{SHDN} = \text{LOW}$, $V_{CC} = 5\text{ V}$, $I_{CCQ} = 195\text{ mA}$, $50\ \Omega$ system impedance, $F_{TEST} = 0.7\text{ to }0.8\text{ GHz}$, $T_{PKG\ HEAT\ SINK} = 25\text{ }^\circ\text{C}$. Evaluation board losses are included within the plots.

GRF5507 Typical Operating Curves: Gain vs. P_{OUT} (9.6 dB PAR)

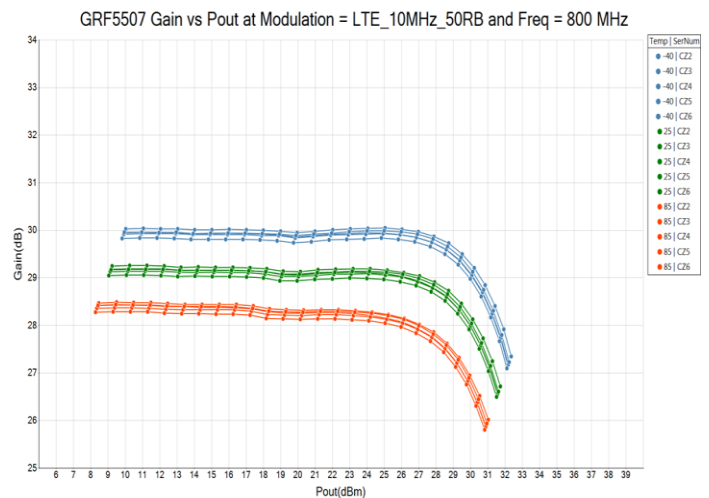
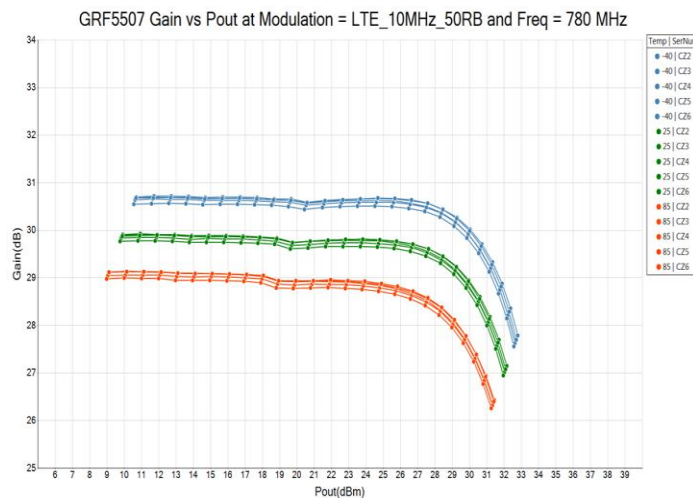
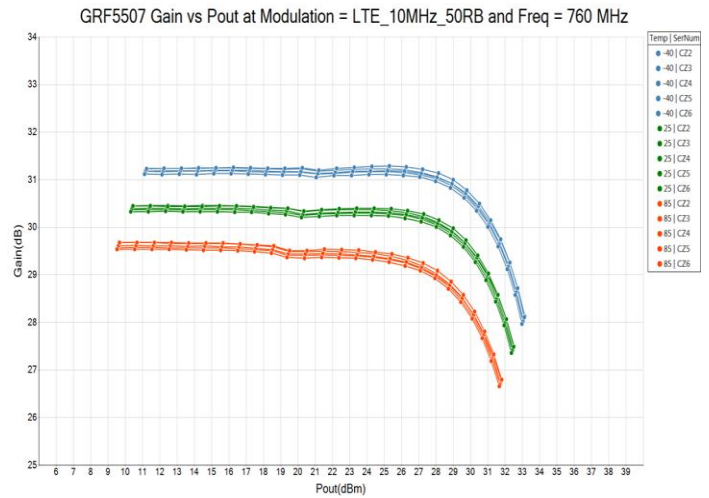
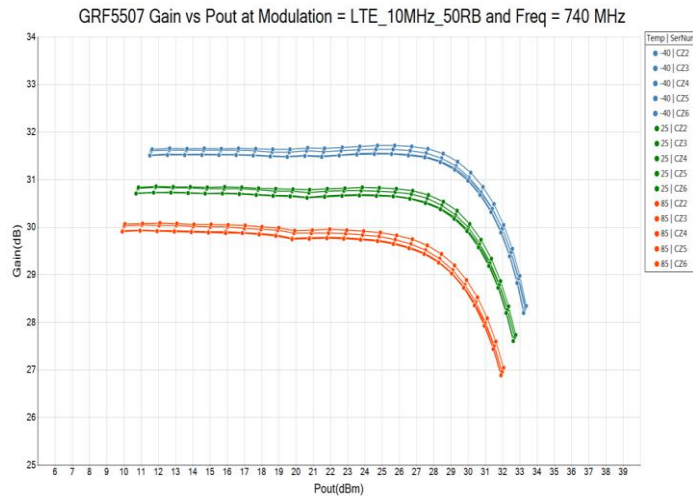
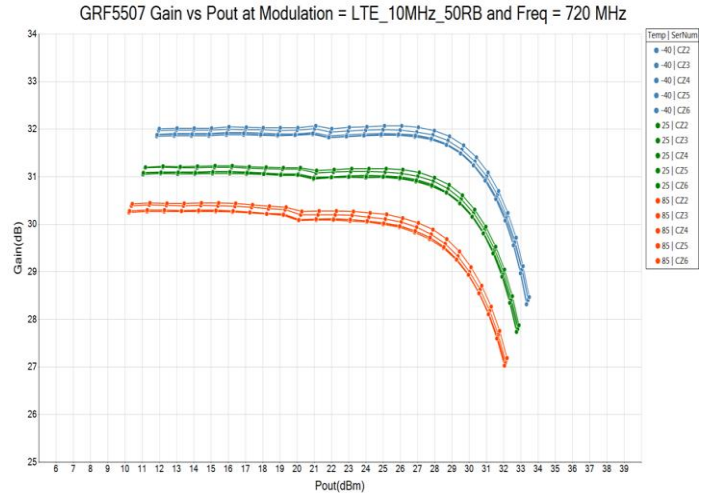
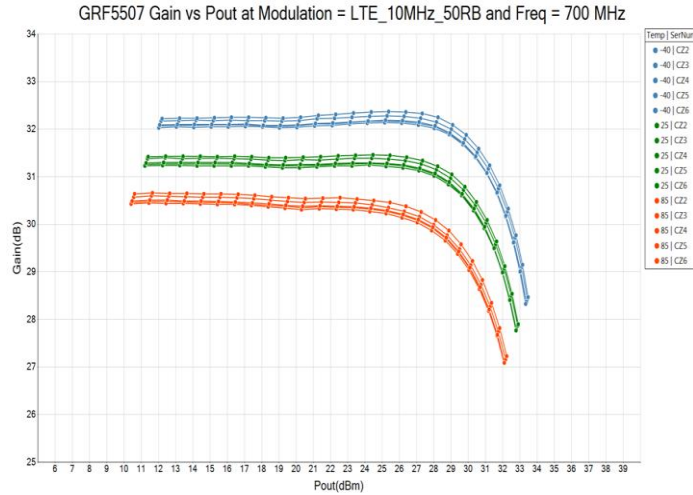

GRF5507 Typical Operating Curves: Gain vs. P_{IN} (Shutdown Mode, $V_{SHDN} = 3.3V$, 9.6dB PAR)

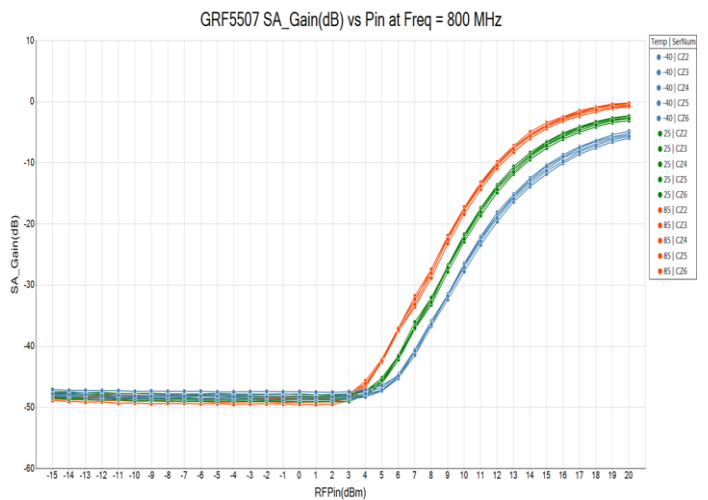
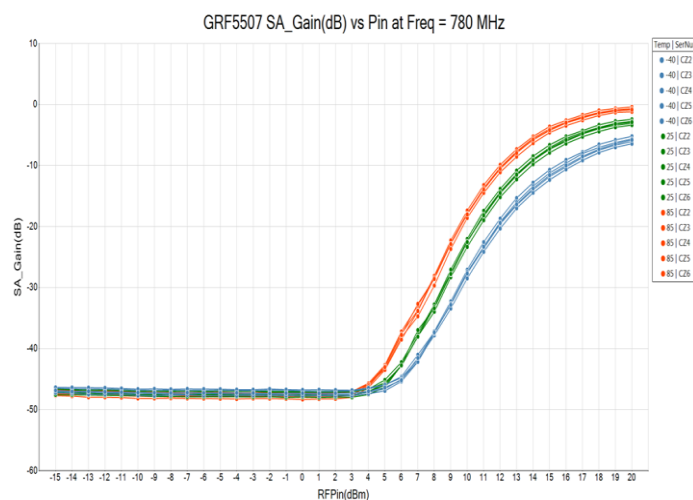
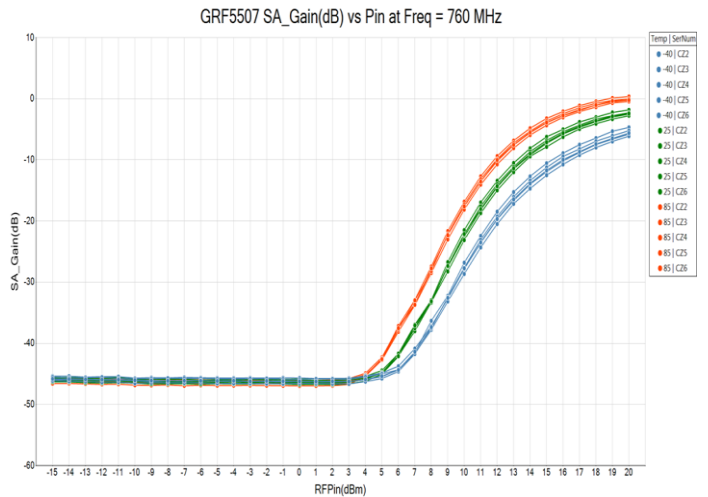
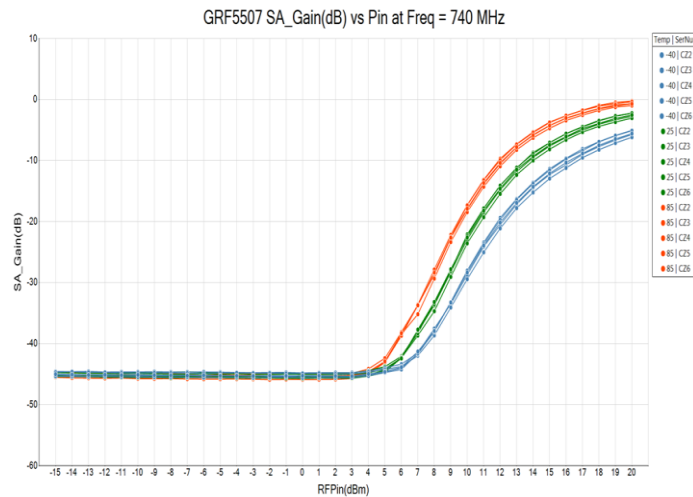
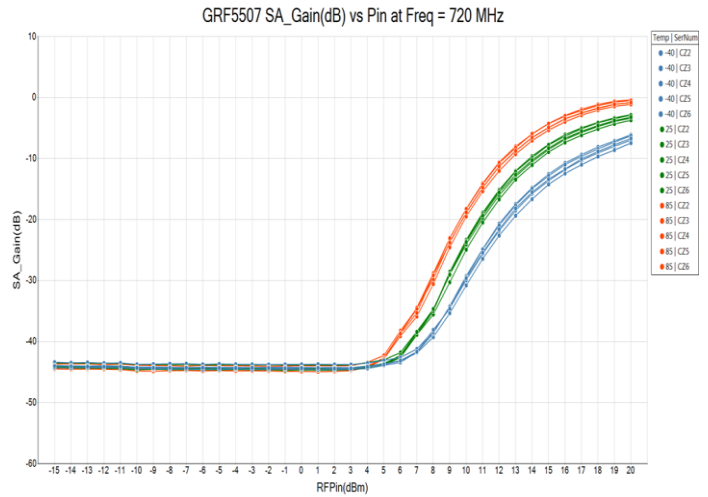
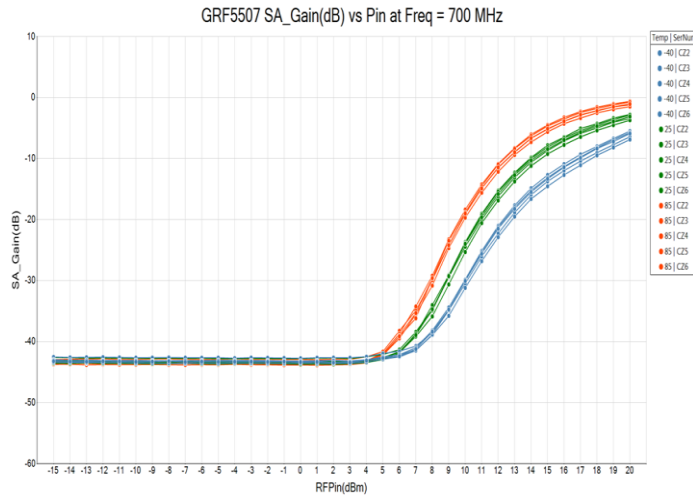

GRF5507 Typical Operating Curves: IMD3 vs. P_{OUT} (600kHz Tone Spacing)

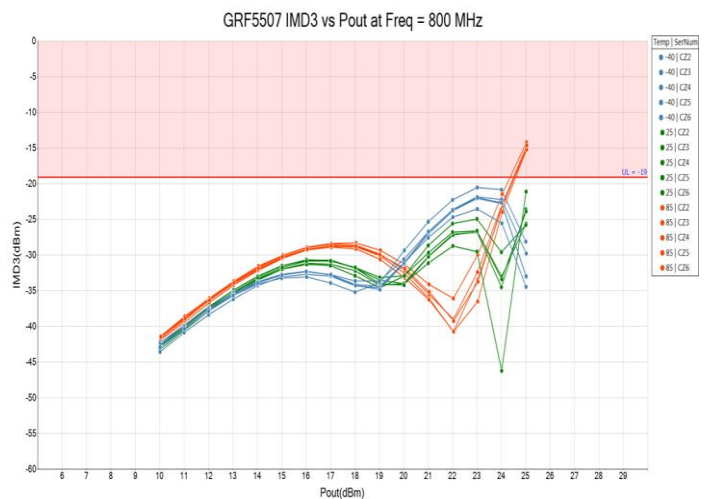
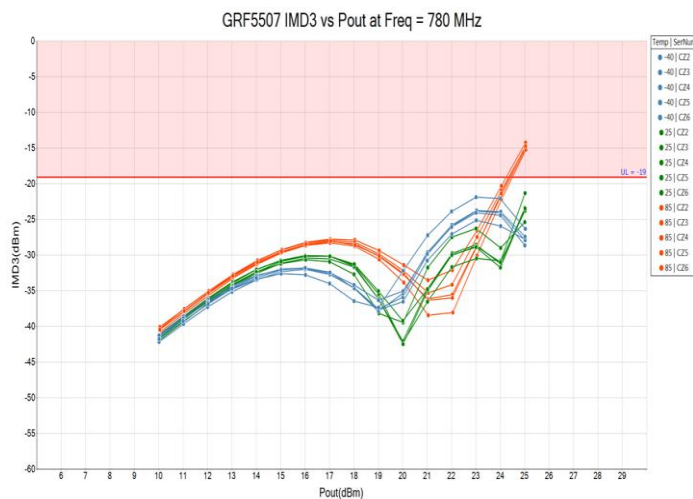
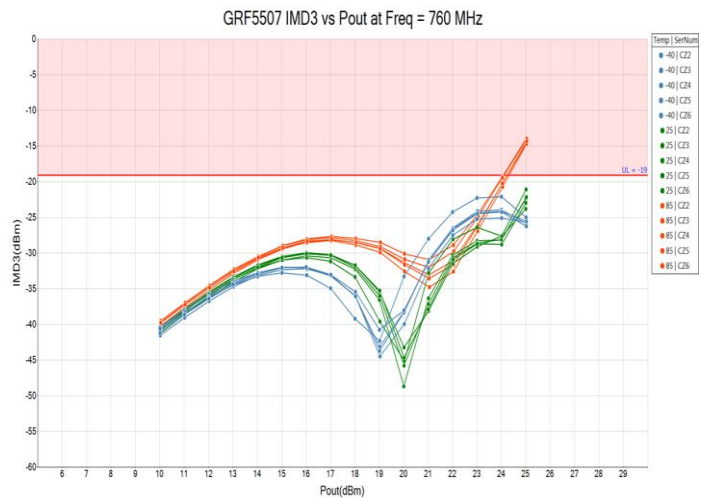
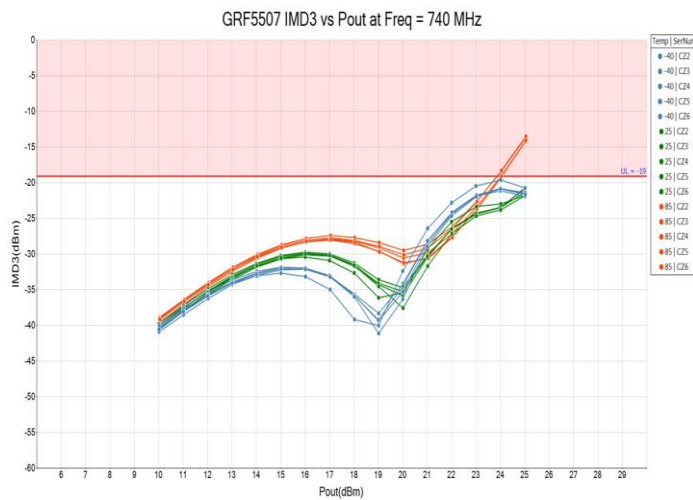
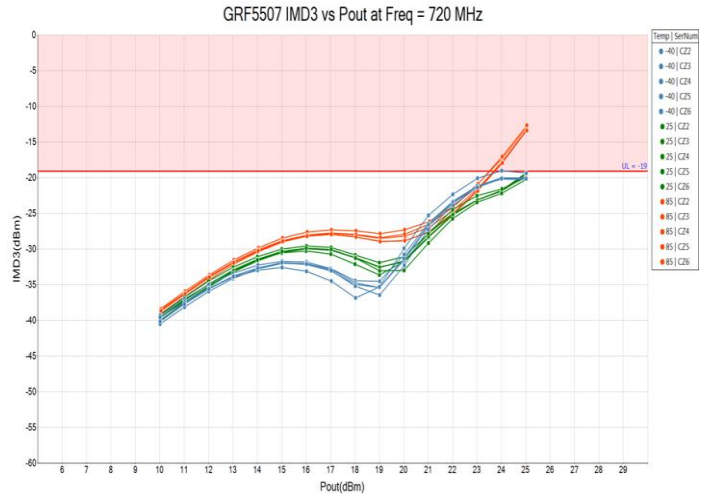
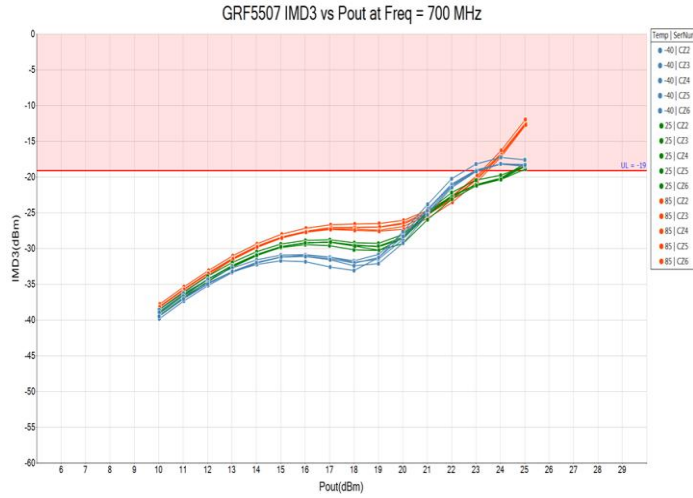

GRF5507 Typical Operating Curves: OIP3 vs. P_{OUT} (600kHz Tone Spacing)

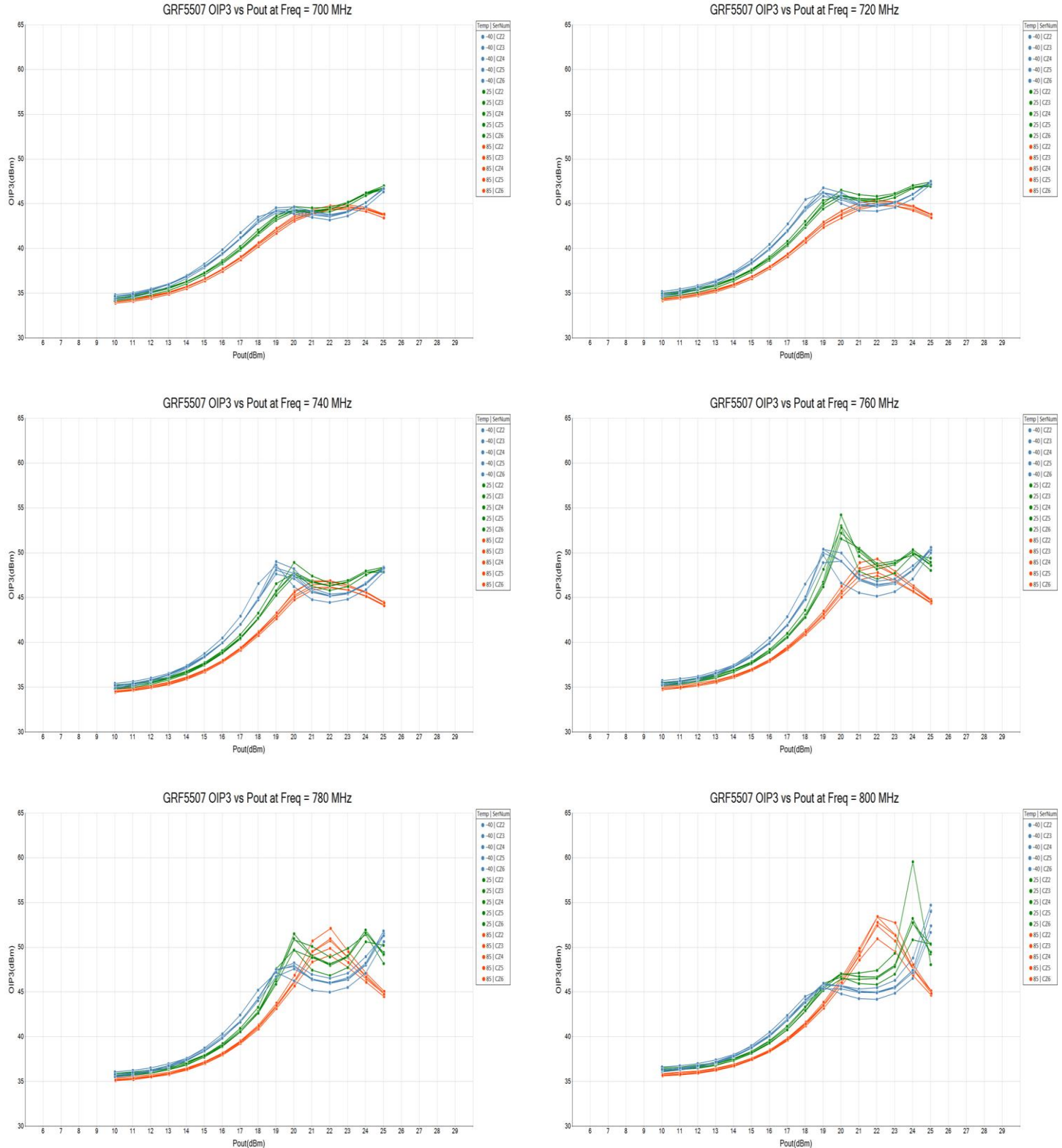

GRF5507 Typical Operating Curves: PAE vs. P_{OUT} (9.6 dB PAR)

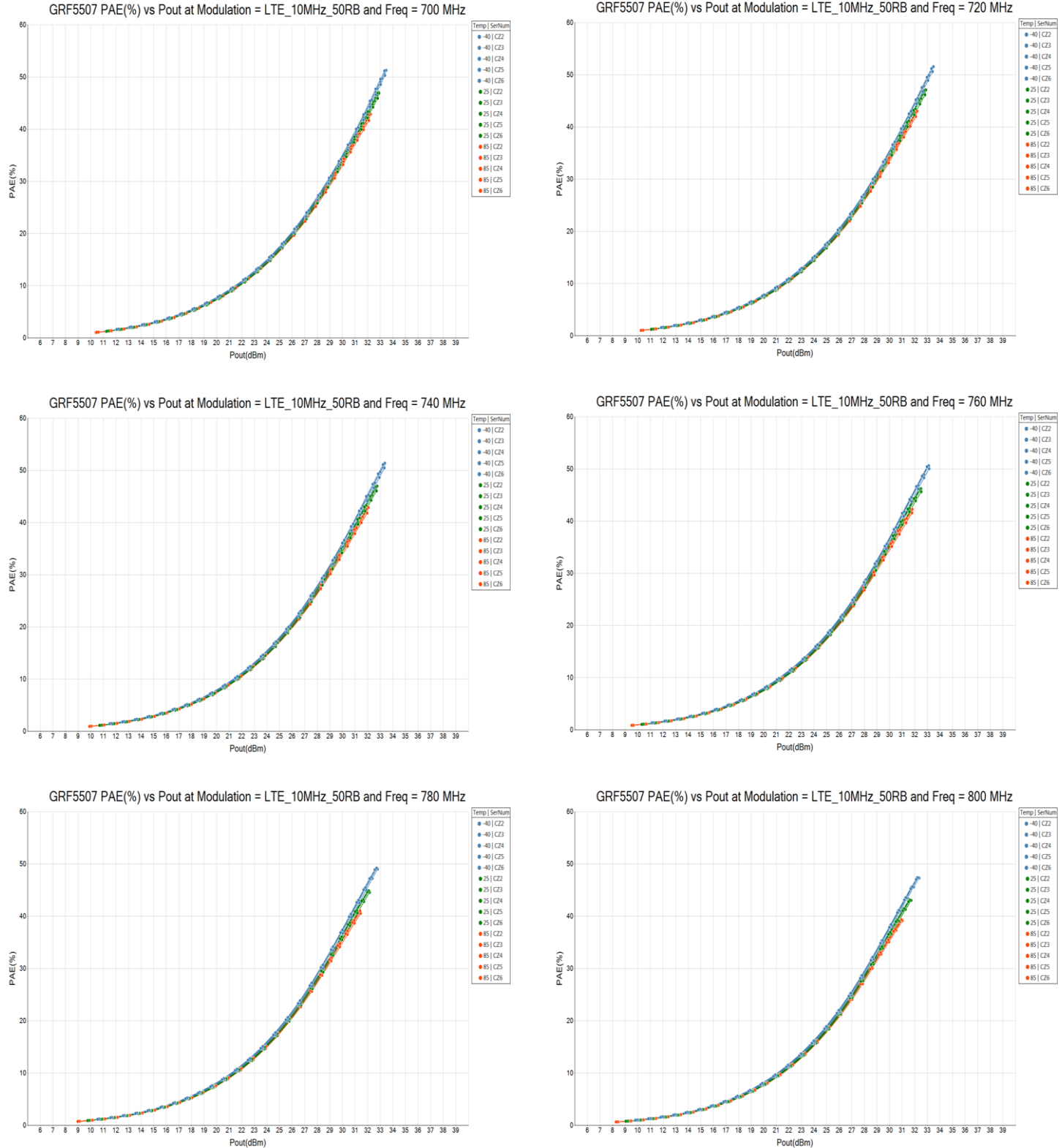

GRF5507 Typical Operating Curves: ACLR vs. P_{OUT} (9.6 dB PAR)

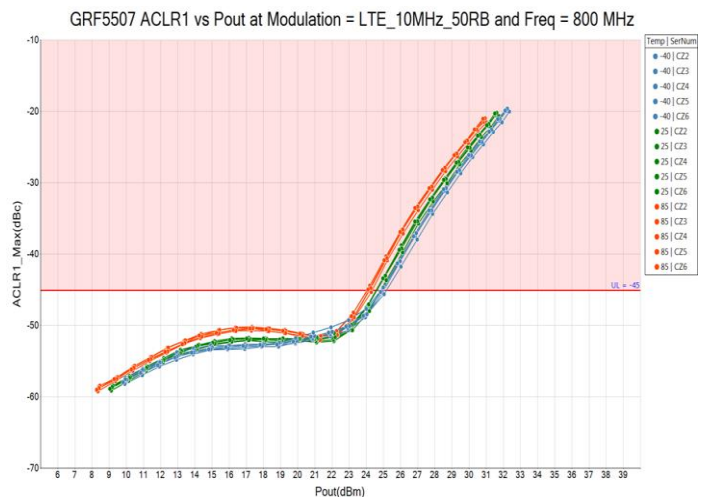
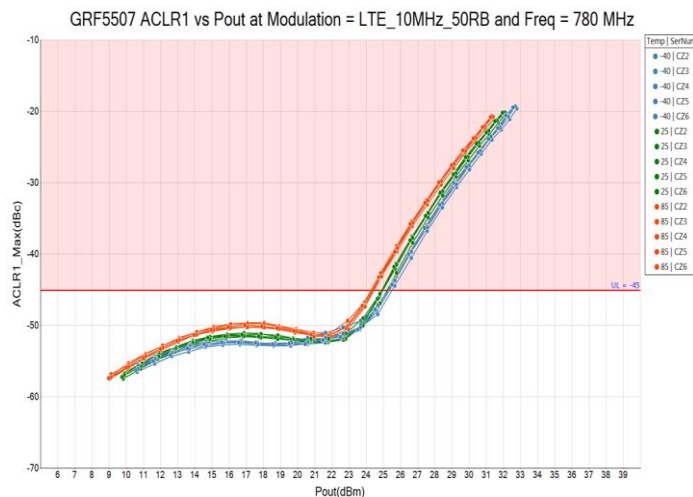
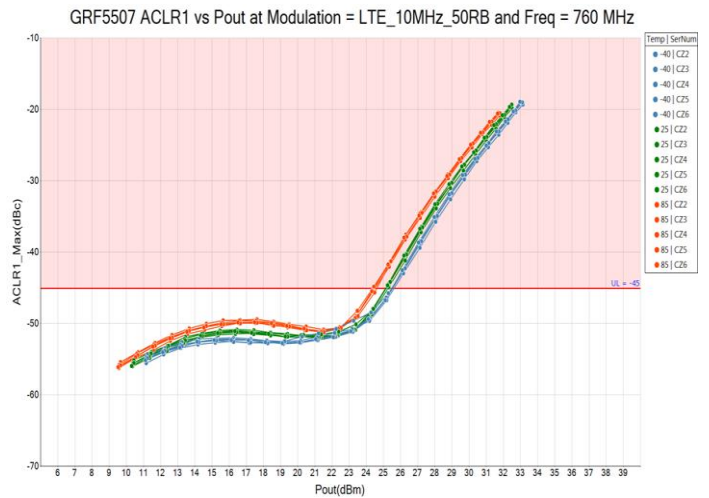
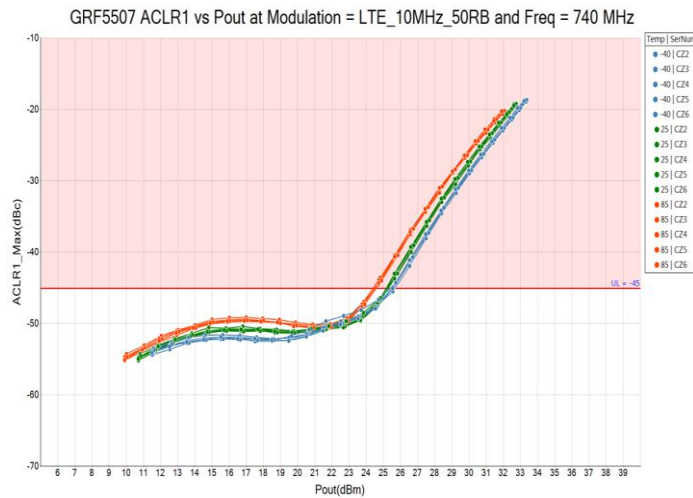
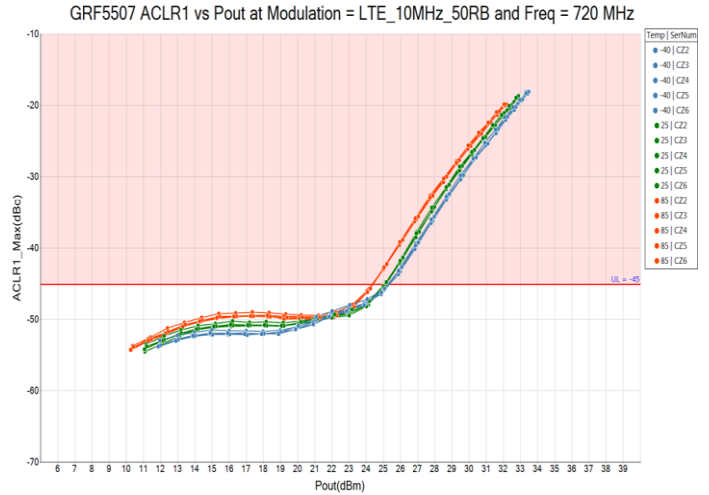
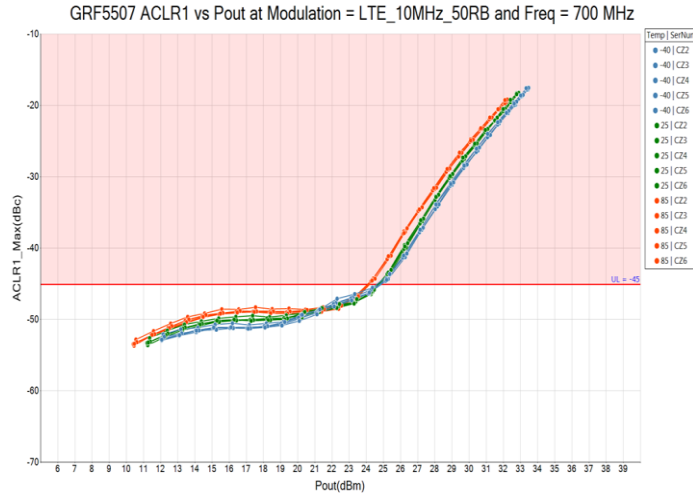

GRF5507 Typical Operating Curves: EVM vs. P_{OUT} (9.6 dB PAR)

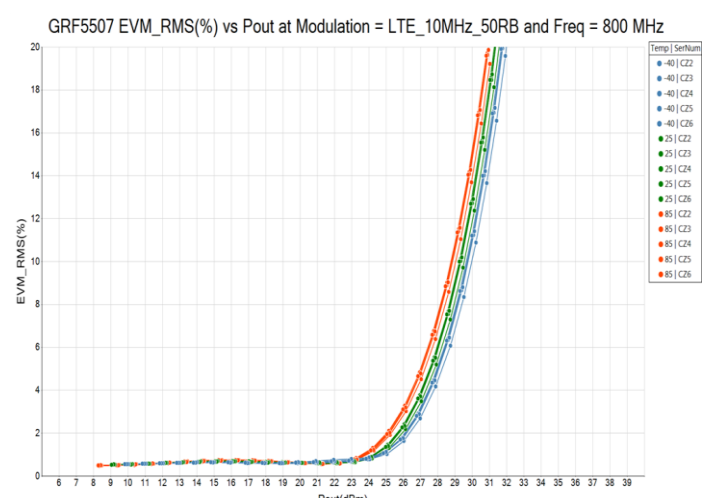
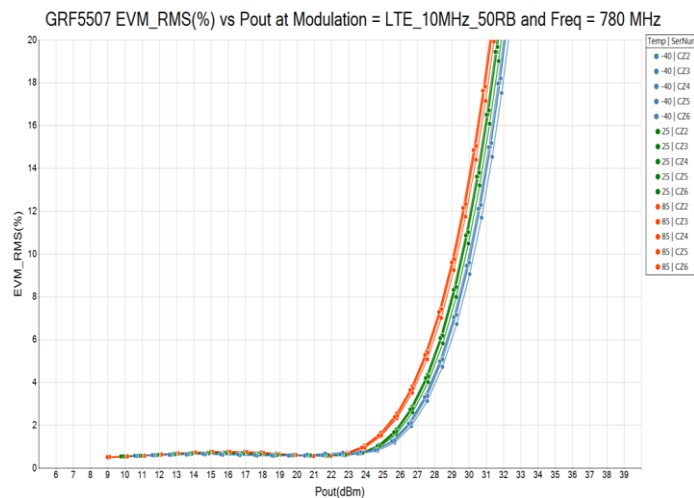
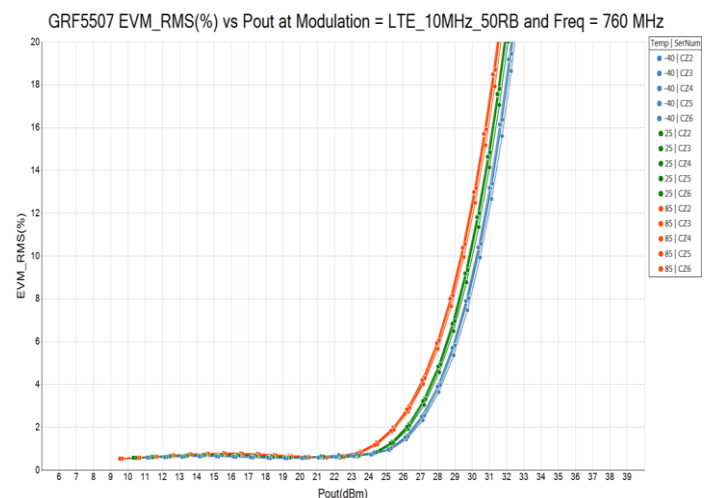
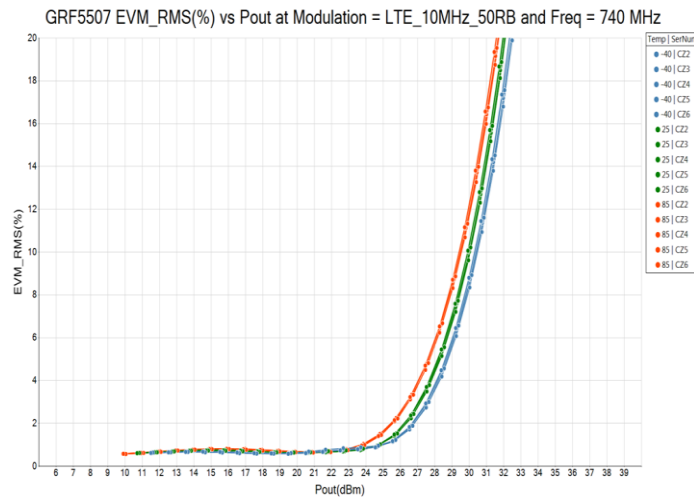
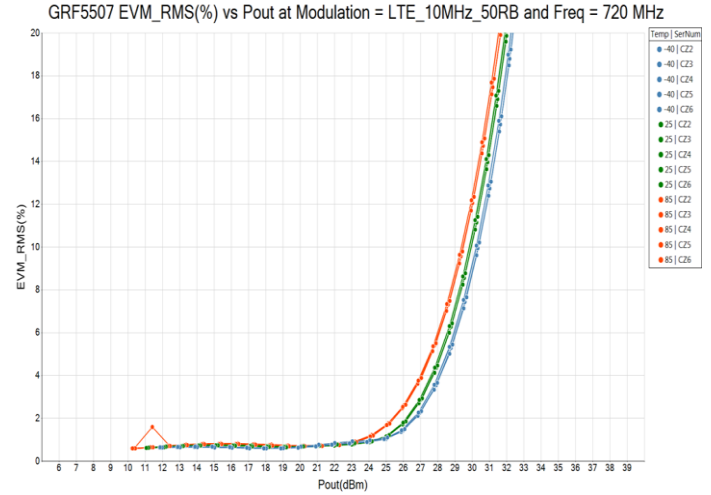
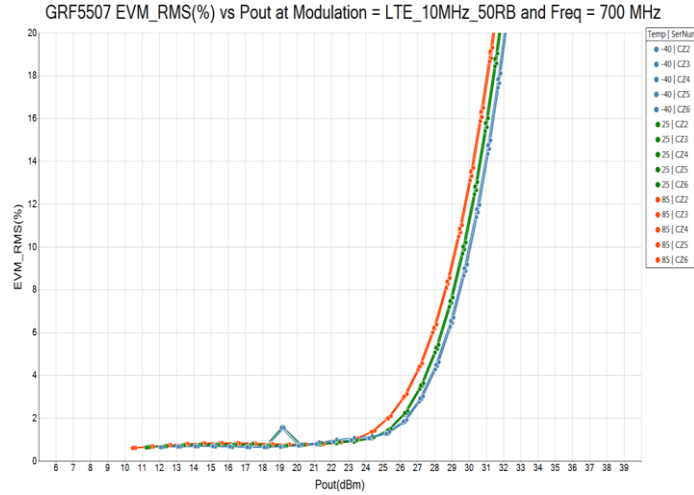

GRF5507 Typical Operating Curves: Stage1 I_{CC} vs. Stage2 P_{OUT} (9.6 dB PAR)

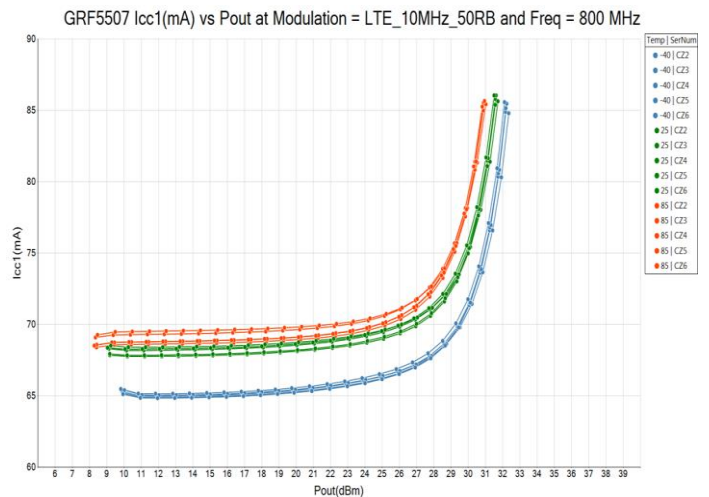
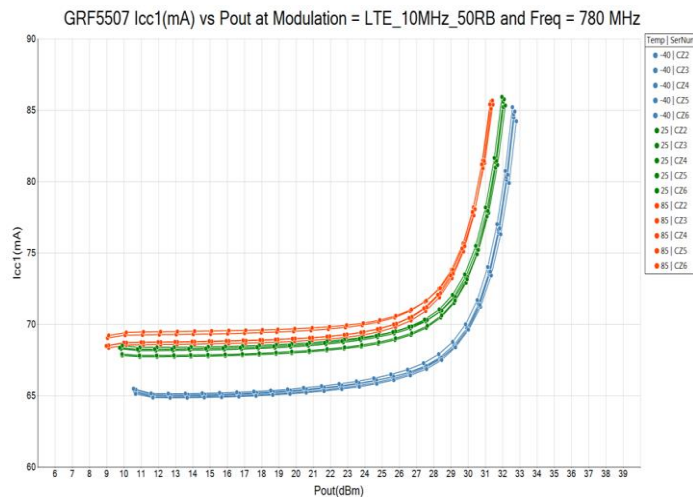
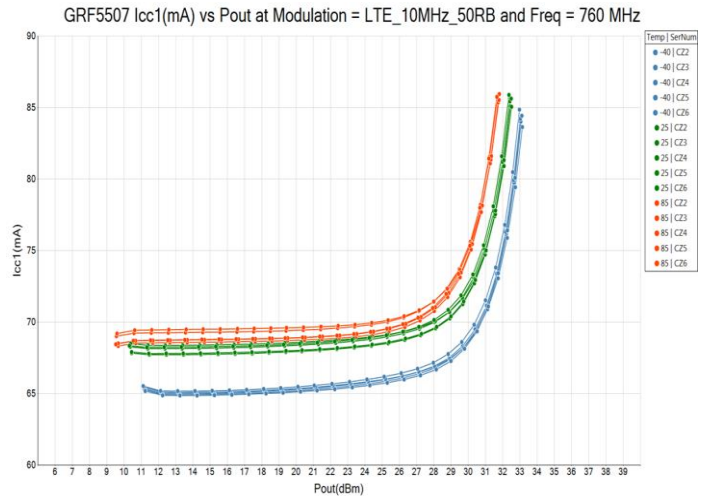
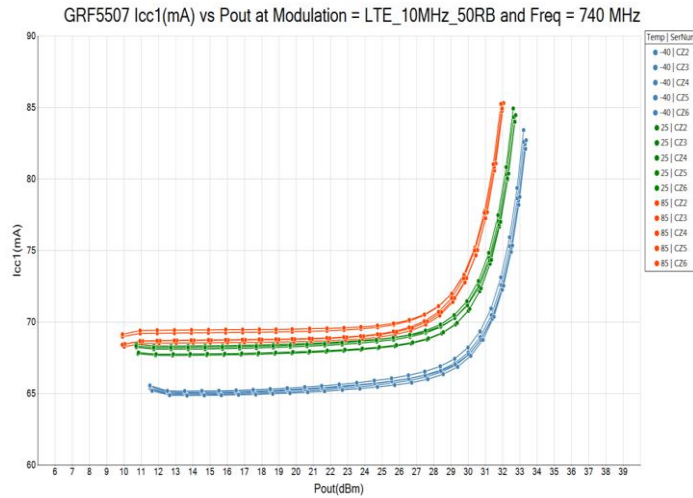
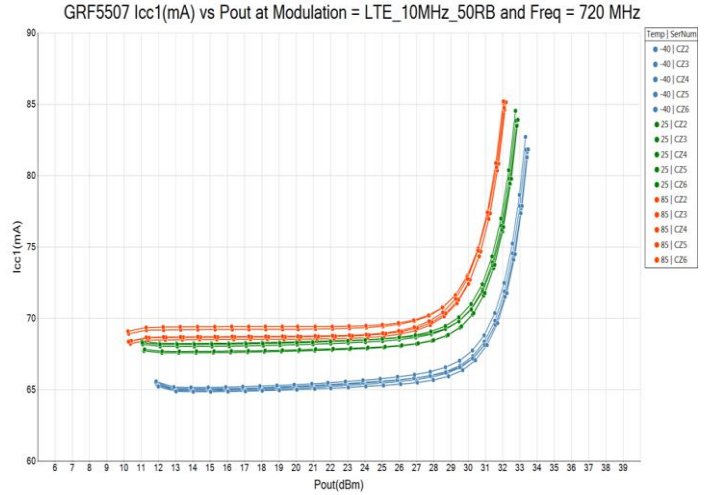
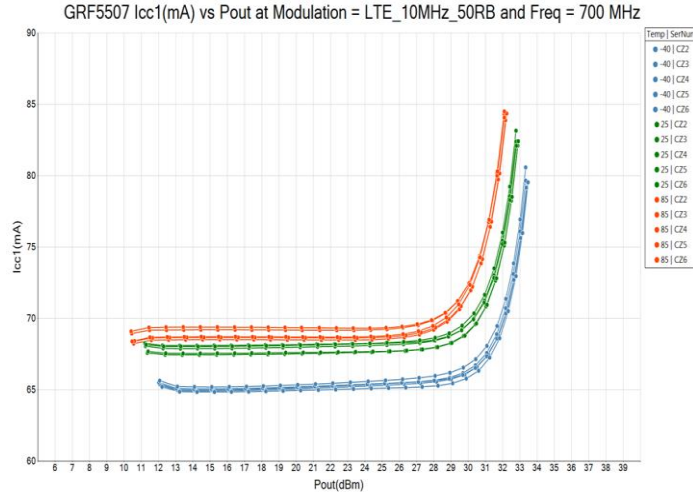

GRF5507 Typical Operating Curves: Stage2 I_{CC} vs. Stage2 P_{OUT} (9.6 dB PAR)

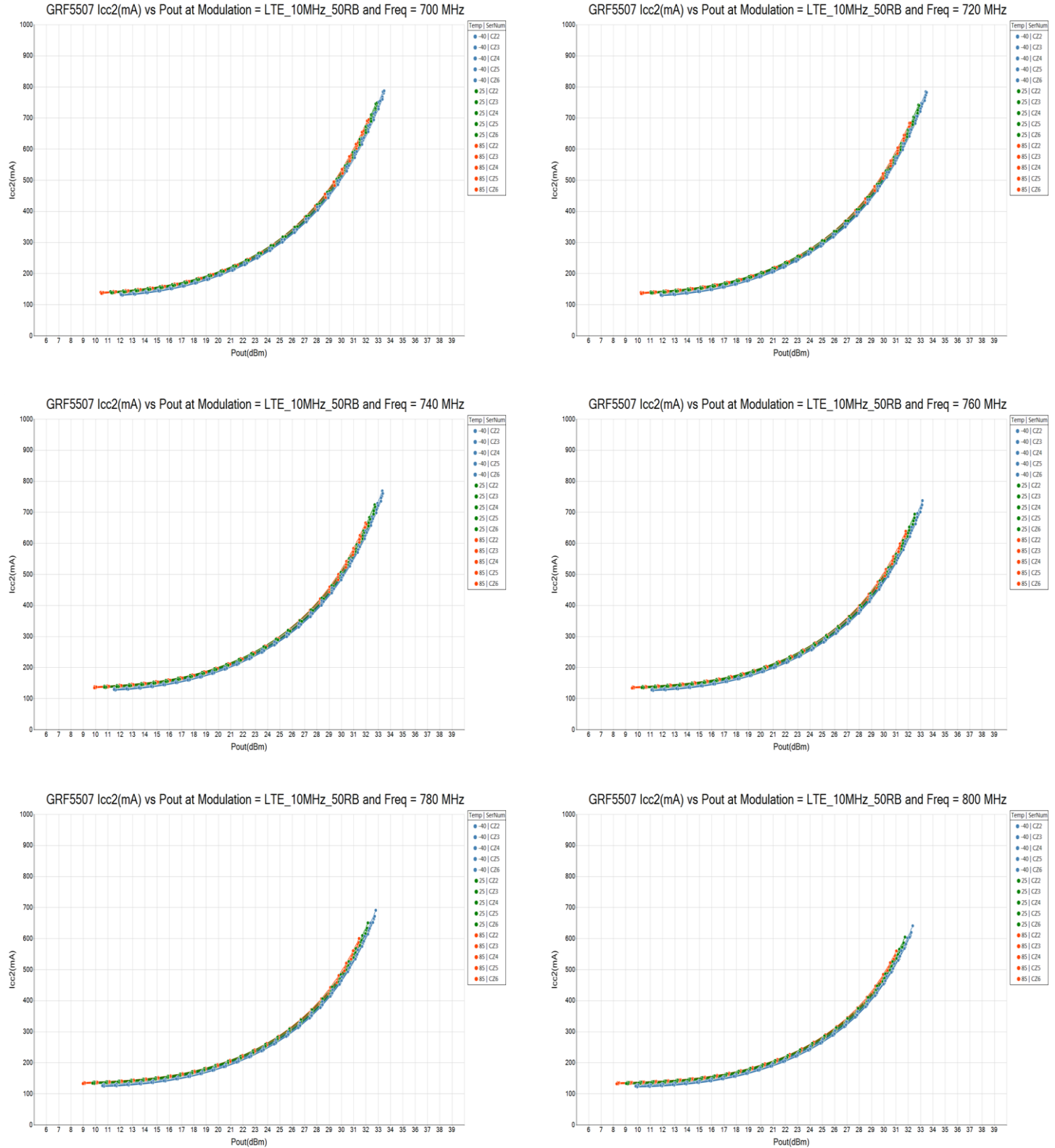

Truth Table

Pin	Logic	Condition
V _{SHDN}	LOW	Full Operation
	HIGH	All Amplifiers Off
V _{EN1}	LOW	Stage 1 Amplifier Off
	HIGH	Stage 1 Amplifier On
V _{EN2}	LOW	Stage 2 Amplifier Off
	HIGH	Stage 2 Amplifier On

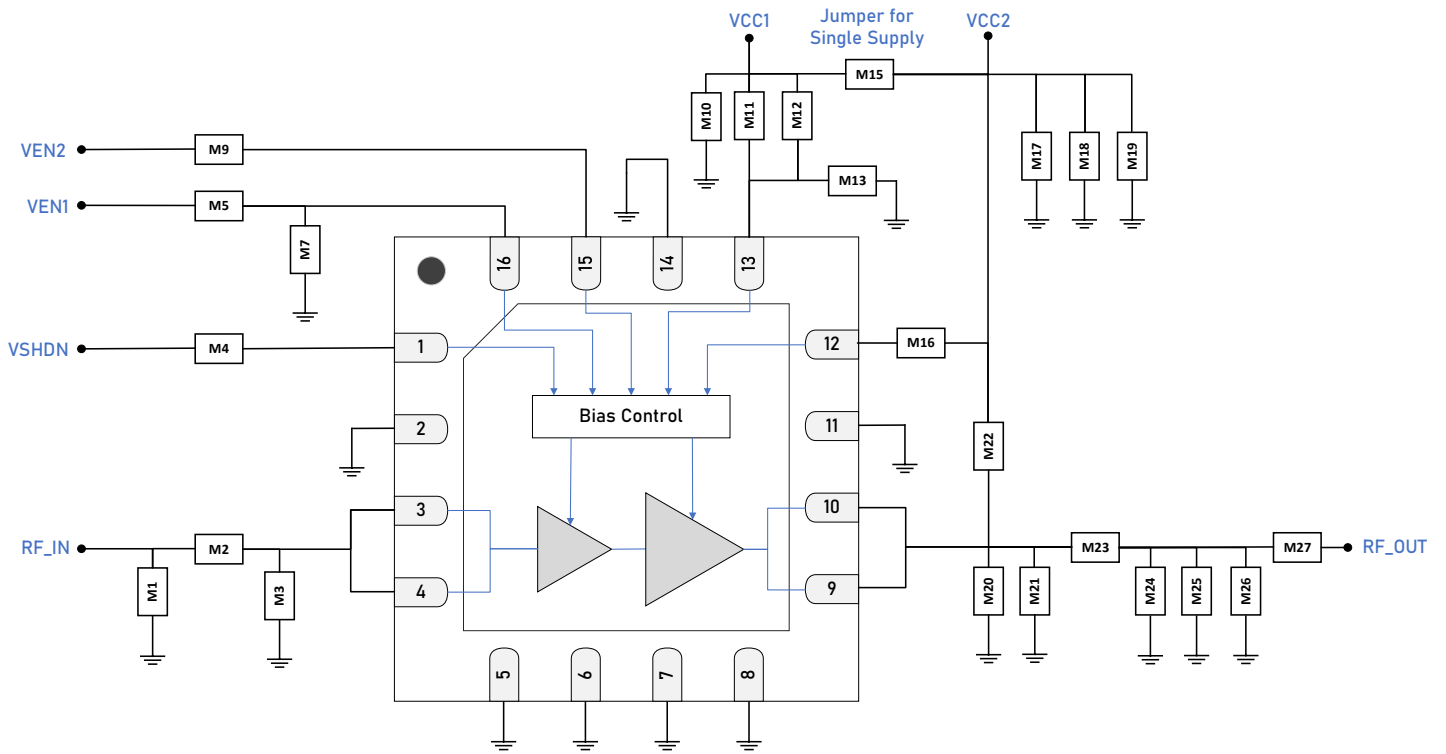

GRF5507 Application Schematic

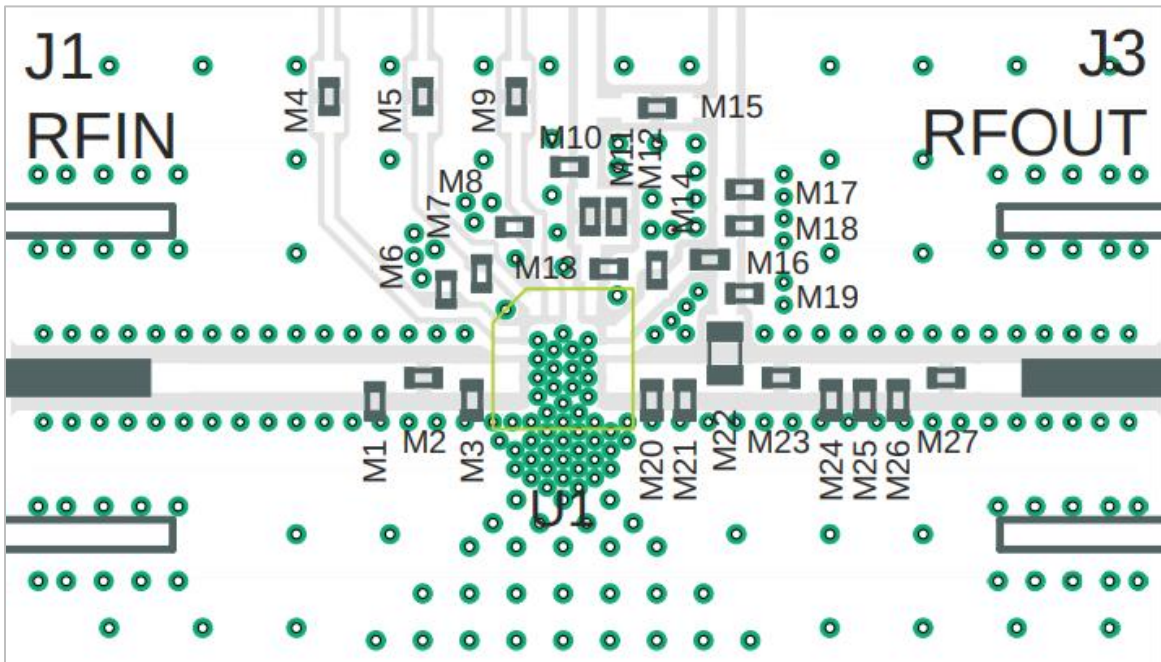

GRF5507 Evaluation Board Assembly Diagram

GRF5507 Evaluation Board Assembly Diagram Reference

Component	Type	Manufacturer	Family	Value	Package Size	Substitution
M1	Inductor	Murata	LQG	8.2 nH	0402	ok
M2	Capacitor	Murata	GJM	6.8 pF	0402	ok
M3	DNP					
M4	Resistor	Various	5%	0 Ω	0402	ok
M5	Resistor	Various	5%	1.7 kΩ	0402	ok
M7	Capacitor	Murata	GRM	100 pF	0402	ok
M9	Resistor	Various	5%	3.3 kΩ	0402	ok
M10	Capacitor	Murata	GRM	0.1 μF	0402	ok
M11	Inductor	Murata	LQG	8.2 nH	0402	ok
M12	DNP					
M13	DNP					
M15	Resistor	Various	5%	0 Ω	0402	ok
M16	Resistor	Various	5%	0 Ω	0402	ok
M17	DNP					
M18	Capacitor	Murata	GRM	10 μF	0402	ok
M19	Capacitor	Murata	GRM	100 pF	0402	ok
M20	DNP					
M21	DNP					
M22	Inductor: High Q	Murata	LQW	24 nH	0603	ok
M23	Inductor: High Q	Murata	LQW	2.4 nH	0402	ok
M24	Capacitor	Murata	GJM	10 pF	0402	ok
M25	DNP					
M26	DNP					
M27	Capacitor	Murata	GJM	47 pF	0402	ok
Evaluation Board	QFN16-30-24-B					

 Note: Standard evaluation board bias: V_{CC} : 5.0 V; V_{ENABLE} : 5.0 V.

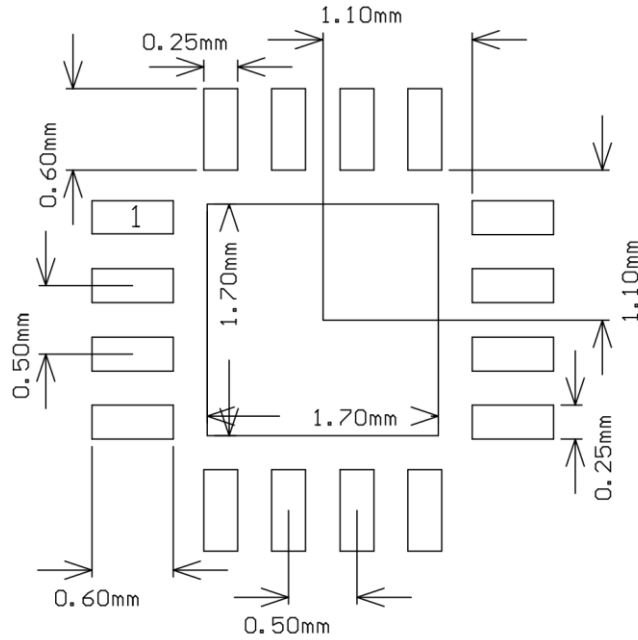

3 x 3 mm QFN-16 Suggested PCB Footprint (Top View)

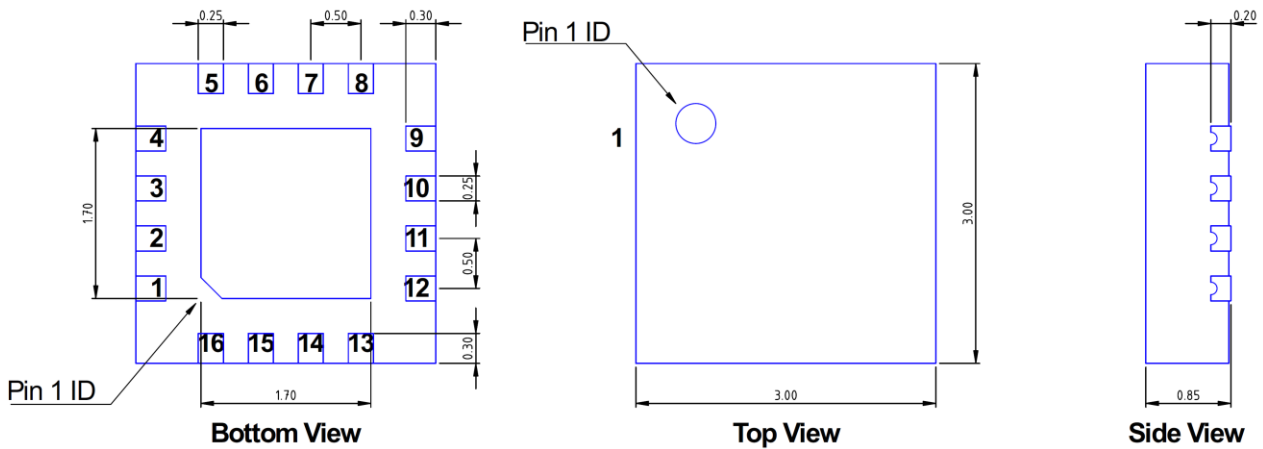

QFN16 3x3mm
Dimensions in millimeters

3 x 3 mm QFN-16 Package Dimensions

Package Marking Diagram



Line 1 "XXXX" = PART NUMBER

Line 2 "YY" = YEAR and "WW" = WEEK that the part was assembled.

Tape and Reel Information

Guerrilla RF's tape and reel specification complies with Electronics Industries Association (EIA) standards for "Embossed Carrier Tape of Surface Mount Components for Automatic Handling" (reference EIA-481). See the following page for the Tape and Reel Specification and Device Package Information table, which includes units per reel.

Devices are loaded with pins down into the carrier pocket with protective cover tape and reeled onto a plastic reel. Each reel is packaged in a cardboard box. There are product labels on the reel, the protective ESD bag and the outside surface of the box.

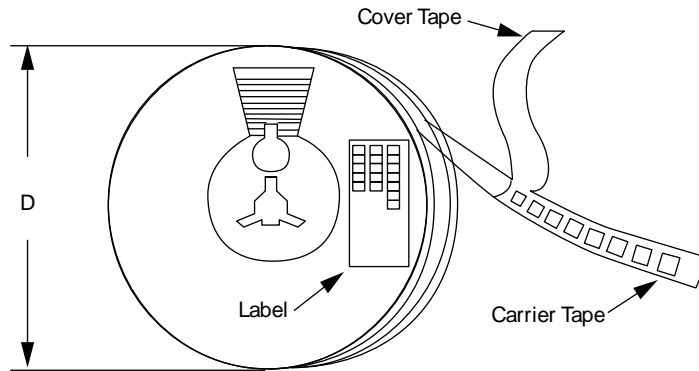

Tape and Reel Packaging with Reel Diameter Noted (D)

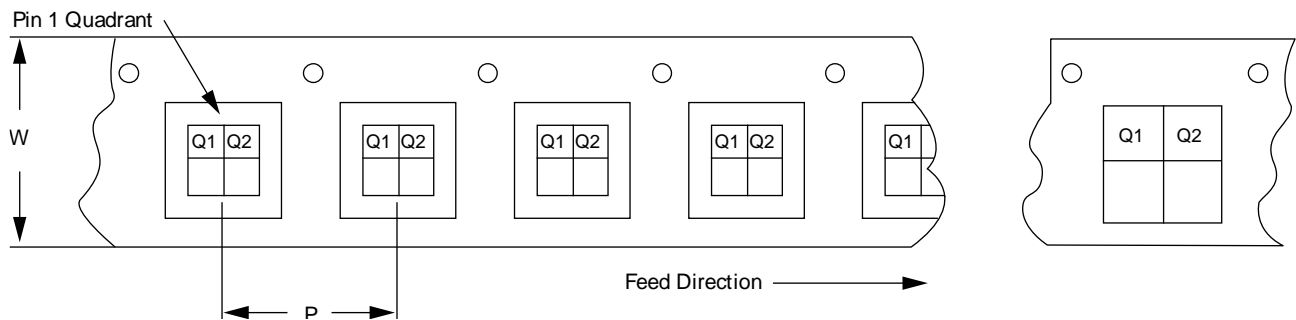

Carrier Tape Width (W), Pitch (P), Feed Direction and Pin 1 Quadrant Information

Tape and Reel Specification and Device Package Information

Package				Carrier Tape			Reel	
Type	Dimensions (mm)	Leads	Weight (mg)	Width (W) (mm)	Pocket Pitch (P) (mm)	Pin 1 Quadrant	Diameter (D) (Inches)	Units per Reel
QFN	2.0 x 2.0 x 0.50	12	7	8	4	Q1	7	2500
QFN	3.0 x 3.0 x 0.85	16	24	12	8	Q1	7	1500
DFN	1.5 x 1.5 x 0.45	6	4	8	4	Q1	7	2500
DFN	2.0 x 2.0 x 0.75	8	12	8	4	Q1	7	2500
LFM	3.5 x 3.5 x 0.75	See Note	TBD	12	8	Q2	7	1500
LFM	4.0 x 4.0 x 0.75	See Note	TBD	12	8	Q2	7	1500

Note: Lead count may vary. Reference applicable product data sheet.

Revision History

Revision Date	Description of Change
August 24, 2020	Preliminary Datasheet update. Converted format to new template. Added typical operating curves.
October 15, 2020	Release 0 update. Added components to the assembly diagram table. Updated suggested PCB footprint drawing.

Datasheet Classifications

Data Sheet Status	Notes
Advance	S-parameter and NF data based on EM simulations for the fully packaged device using foundry-supplied transistor S-parameters. Linearity estimates based on device size, bias condition and experience with related devices.
Preliminary	All data based on evaluation board measurements taken within the Guerrilla RF Applications Lab. Any MIN/MAX limits represented within the datasheet are based solely on <i>estimated</i> part-to-part variations and process spreads. All parametric values are subject to change pending the collection of additional data.
Release Ø	All data based on measurements taken with <i>production-released</i> material. TYP values are based on a combination of ATE and bench-level measurements, with MIN/MAX limits defined using <i>modelled estimates</i> that account for part-to-part variations and expected process spreads. Although unlikely, future refinements to the TYP/MIN/MAX values may be in order as multiple lots are processed through the factory.
Release A-Z	All data based on measurements taken with production-released material <i>derived from multiple lots which have been fabricated over an extended period of time</i> . MIN/MAX limits may be refined over previous releases as more statistically significant data is collected to account for process spreads.

Information in this datasheet is specific to the Guerrilla RF, Inc. ("Guerrilla RF") product identified.

This datasheet, including the information contained in it, is provided by Guerrilla RF as a service to its customers and may be used for informational purposes only by the customer. Guerrilla RF assumes no responsibility for errors or omissions on this datasheet or the information contained herein. Information provided is believed to be accurate and reliable, however, no responsibility is assumed by Guerrilla RF for its use, nor for any infringement of patents, or other rights of third parties, resulting from its use. Guerrilla RF assumes no liability for any datasheet, datasheet information, materials, products, product information, or other information provided hereunder, including the sale, distribution, reproduction or use of Guerrilla RF products, information or materials.

No license, whether express, implied, by estoppel, by implication or otherwise is granted by this datasheet for any intellectual property of Guerrilla RF, or any third party, including without limitation, patents, patent rights, copyrights, trademarks and trade secrets. All rights are reserved by Guerrilla RF.

All information herein, products, product information, datasheets, and datasheet information are subject to change and availability without notice. Guerrilla RF reserves the right to change component circuitry, recommended application circuitry and specifications at any time without prior notice. Guerrilla RF may further change its datasheet, product information, documentation, products, services, specifications or product descriptions at any time, without notice. Guerrilla RF makes no commitment to update any materials or information and shall have no responsibility whatsoever for conflicts, incompatibilities, or other difficulties arising from any future changes.

GUERRILLA RF INFORMATION, PRODUCTS, PRODUCT INFORMATION, DATASHEETS AND DATASHEET INFORMATION ARE PROVIDED "AS IS" AND WITHOUT WARRANTY OF ANY KIND, WHETHER EXPRESS, IMPLIED, STATUTORY, OR OTHERWISE, INCLUDING FITNESS FOR A PARTICULAR PURPOSE OR USE, MERCHANTABILITY, PERFORMANCE, QUALITY OR NON-INFRINGEMENT OF ANY INTELLECTUAL PROPERTY RIGHT; ALL SUCH WARRANTIES ARE HEREBY EXPRESSLY DISCLAIMED. GUERRILLA RF DOES NOT WARRANT THE ACCURACY OR COMPLETENESS OF THE INFORMATION, TEXT, GRAPHICS OR OTHER ITEMS CONTAINED WITHIN THESE MATERIALS. GUERRILLA RF SHALL NOT BE LIABLE FOR ANY DAMAGES, INCLUDING BUT NOT LIMITED TO ANY SPECIAL, INDIRECT, INCIDENTAL, STATUTORY, OR CONSEQUENTIAL DAMAGES, INCLUDING WITHOUT LIMITATION, LOST REVENUES OR LOST PROFITS THAT MAY RESULT FROM THE USE OF THE MATERIALS OR INFORMATION, WHETHER OR NOT THE RECIPIENT OF MATERIALS HAS BEEN ADVISED OF THE POSSIBILITY OF SUCH DAMAGE.

Customers are solely responsible for their use of Guerrilla RF products in the Customer's products and applications or in ways which deviate from Guerrilla RF's published specifications, either intentionally or as a result of design defects, errors, or operation of products outside of published parameters or design specifications. Customers should include design and operating safeguards to minimize these and other risks. Guerrilla RF assumes no liability or responsibility for applications assistance, customer product design, or damage to any equipment resulting from the use of Guerrilla RF products outside of stated published specifications or parameters.

Mouser Electronics

Authorized Distributor

Click to View Pricing, Inventory, Delivery & Lifecycle Information:

[Guerrilla RF:](#)

[GRF5507](#)