



## Product Description

GRF2140 is a low noise amplifier (LNA) with bypass designed for high-performance WLAN/ISM and other applications up to 3.8 GHz.

The LNA is operated from a single positive supply of 2.7 to 5.0 V with typical bias condition of 3.3 volts and 18 mA.

Consult with the GRF applications engineering team for custom tuning/evaluation board data and device s-parameters.

## Features

Reference: 3.3V/18mA/1.95 GHz

- EVB NF: 1.1 dB
- Gain: 17.8 dB
- Bypass Gain: -2.5 dB
- OP1dB (Gain Mode): 9.3 dBm
- OP1dB (Bypass Mode): 21.8 dBm
  
- Flexible voltage: 2.7 to 5.0 volts
- Optimal for low Iddq to 8 mA
- Simple matching to 50 ohms
- Process: GaAs pHEMT

## Applications

- WiFi Access Points
- Mobile WiFi Devices
- Cellular Boosters
- Drones
- UHF/900/2400 ISM

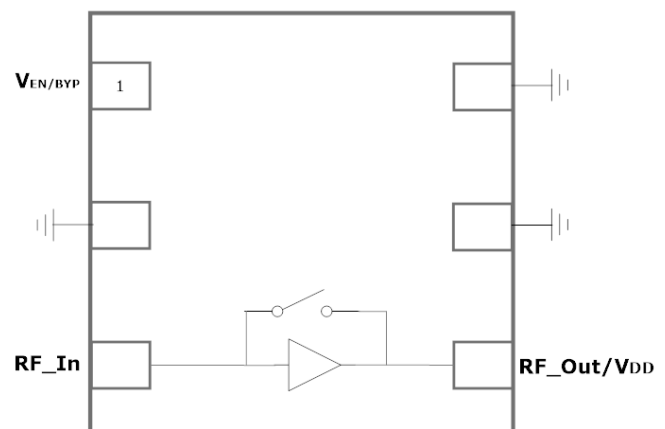

1.5 x 1.5 mm DFN-6

## Absolute Ratings:

Parameter	Symbol	Min.	Max.	Unit
Supply Voltage	V <sub>DD</sub>	0	6.0	V
RF Input Power: (Load VSWR < 2:1; V <sub>D</sub> : 5.0 volts)	P <sub>IN MAX</sub>		15	dBm
Operating Temperature (Package Heat Sink)	T <sub>AMB</sub>	-40	105	°C
Maximum Channel Temperature (MTTF > 10 <sup>6</sup> Hours)	T <sub>MAX</sub>		170	°C
Maximum Dissipated Power	P <sub>DISS MAX</sub>		200	mW
<b>Electrostatic Discharge:</b>				
Charged Device Model:	CDM	1500		V
Human Body Model:	HBM	250		V
<b>Storage:</b>				
Storage Temperature	T <sub>STG</sub>	-65	150	°C
Moisture Sensitivity Level	MSL		1	--



**Caution!** ESD Sensitive Device



Exceeding Absolute Maximum Rating conditions may cause permanent damage to the device.

**Note:** For manufacturing information, see the [Guerrilla-RF.com](http://Guerrilla-RF.com) website for the following document located on the GRF2140 landing page: **Manufacturing Note—MN-001 Product Tape and Reel, Solderability and Package Outline Specification.**

[Link to manufacturing note](#)

## Pin Out (Top View)

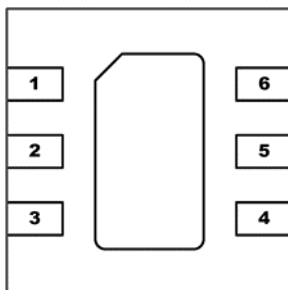

## Pin Assignments:

Pin	Name	Description	Note
1	<b>VENABLE/BYPASS</b>	LNA enable/Bypass Control	VENABLE and series resistor set I <sub>DDQ</sub> . VENABLE < 0.3 volts disables device. On-die pull-down resistor will turn the part off if this node is allowed to float.
2	<b>NC</b>	No Connect or Ground	No internal connections to die
3	<b>RF_In</b>	LNA RF input	Requires external DC block.
4	<b>RF_Out/V<sub>DD</sub></b>	LNA RF output	Requires external bias inductor followed by DC block.
5	<b>NC</b>	No Connect or Ground	No internal connections to die
6	<b>NC</b>	No Connect or Ground	No internal connections to die
<b>PKG BASE</b>	<b>GND</b>	Ground	Provides DC and RF ground for LNA, as well as thermal heat sink. Recommend multiple 8 mil vias beneath the package for optimal RF and thermal performance. Refer to evaluation board top layer graphic on schematic page.

## VENABLE Truth Table:

Mode	Description	VENABLE/BYPASS
High Gain	High LNA Gain	1
Bypass	High Linearity Bypass	0
Logic Level "0"	Logic Low	0.0V to 0.3V
Logic Level "1"	Logic High	1.5V to V <sub>DD</sub>



Released

# GRF2140

Low Current LNA w/Bypass  
Tuning Range: 0.1 to 3.8 GHz

## Nominal Operating Parameters:

Parameter	Symbol	Specification			Unit	Condition
		Min.	Typ.	Max.		
<b>High Gain Mode</b>						V <sub>DD</sub> = 3.3 V; V <sub>ENABLE</sub> : High
Test Frequency	F <sub>TEST</sub>		1.95		GHz	
Gain	S <sub>21</sub>	16.3	17.8	19.3	dB	
Noise Figure (Evaluation Board)	NF		1.1	1.3	dB	
Output 1dB Compression Point	OP1dB	7.3	9.3		dBm	
Output Third Order Intercept Point	OIP3		20.0		dBm	
Switching Time (Bypass to Gain)	T <sub>Gain</sub>		200		ns	
Switching Time (Gain to Bypass)	T <sub>Bypass</sub>		100		ns	
Supply Current	I <sub>DD</sub>	13	18	25	mA	V <sub>DD</sub> =V <sub>enable</sub> =3.3 volts; R <sub>bias</sub> : 500 Ω
Enable Current	I <sub>ENABLE</sub>		1.0	3.0	mA	
<b>Bypass Mode</b>						V <sub>DD</sub> : 3.3 V; Ven: 0.0 V
Gain	S(2,1)	-3.5	-2.5		dB	
Output 1dB Compression Point	OP1dB		21.8		dBm	
Output Intercept Point	OIP3		39.0		dBm	
<b>Thermal Data</b>						
Thermal Resistance (Infra-Red Scan)	Θ <sub>jc</sub>		235		°C/W	
Channel Temperature @ +85 C reference (Package heat sink)	T <sub>CHANNEL</sub>		99 (See note)		°C	V <sub>DD</sub> : 3.3 V; I <sub>DDQ</sub> : 18 mA; No RF; Dissipated Power: 59 mW

Note: MTTF >10<sup>6</sup> hours for T<sub>CHANNEL</sub> < =170 degrees C.



Released

# GRF2140

Low Current LNA w/Bypass  
Tuning Range: 0.1 to 3.8 GHz

## GRF2140 Evaluation Board Measured Data:

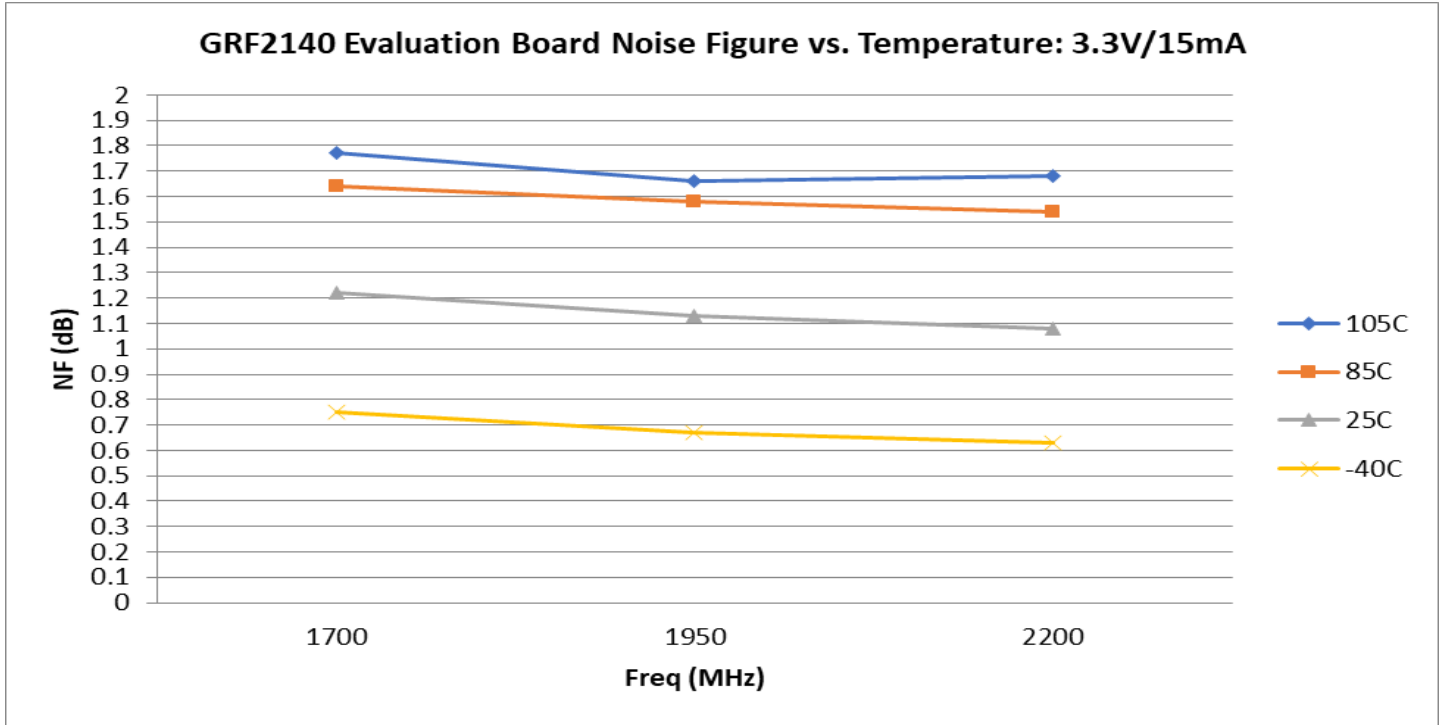

GRF2140 Evaluation Board Measured Data:

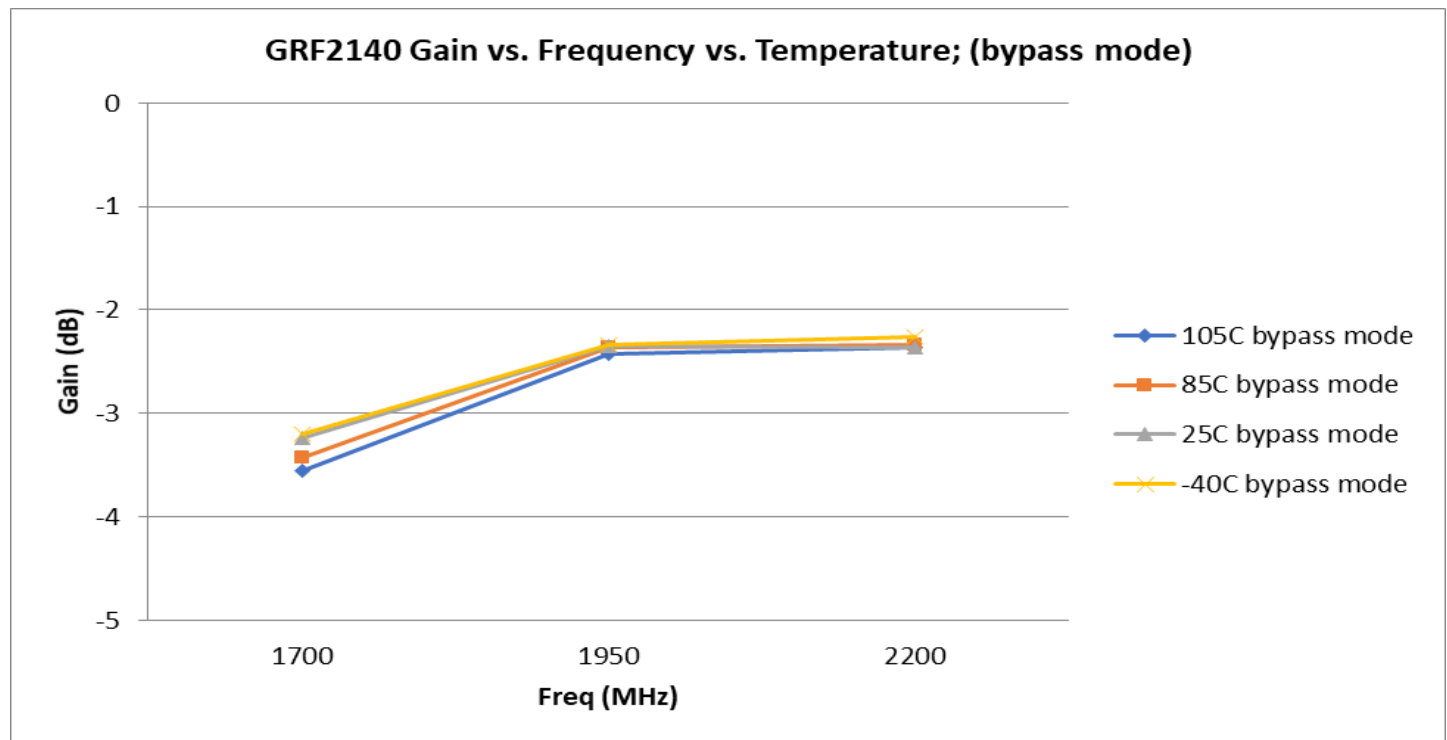
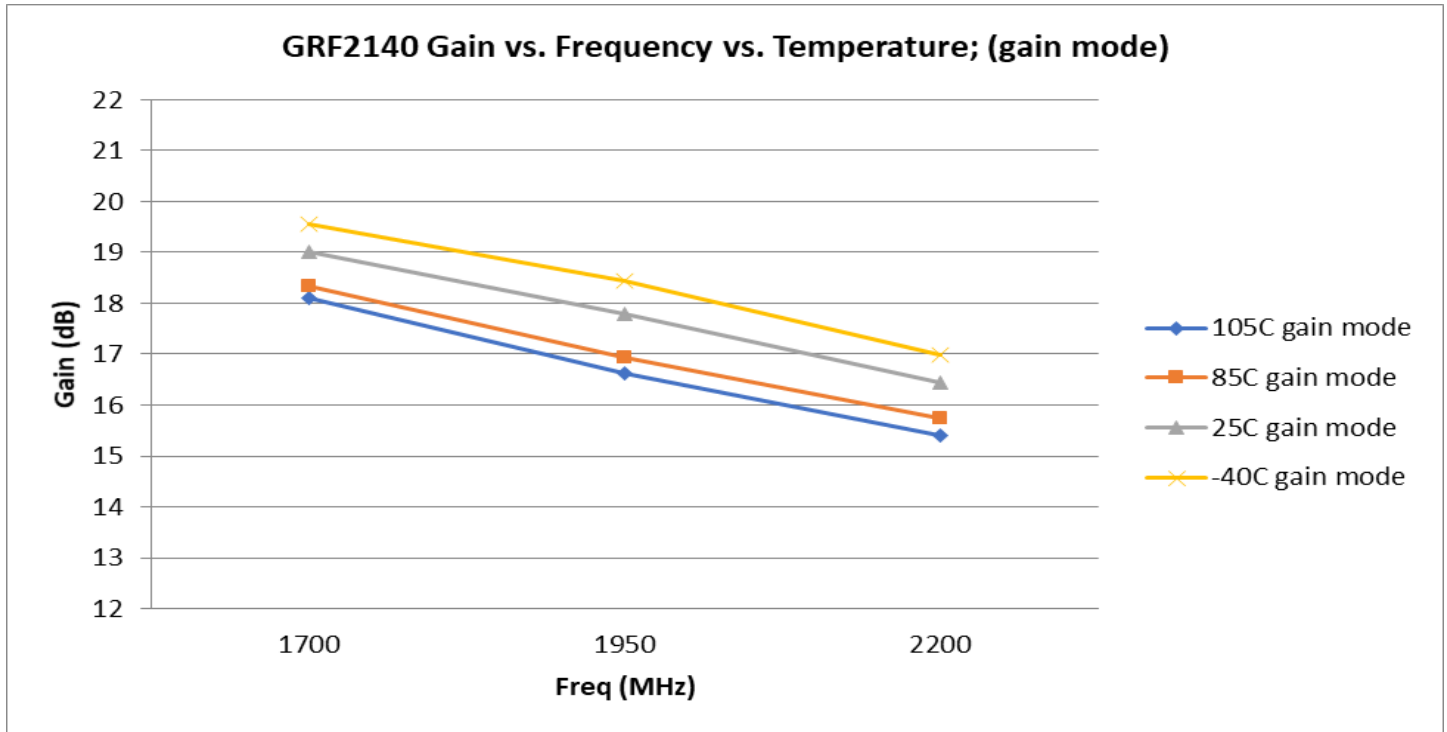



Released

# GRF2140

Low Current LNA w/Bypass  
Tuning Range: 0.1 to 3.8 GHz

## GRF2140 Evaluation Board Measured Data:

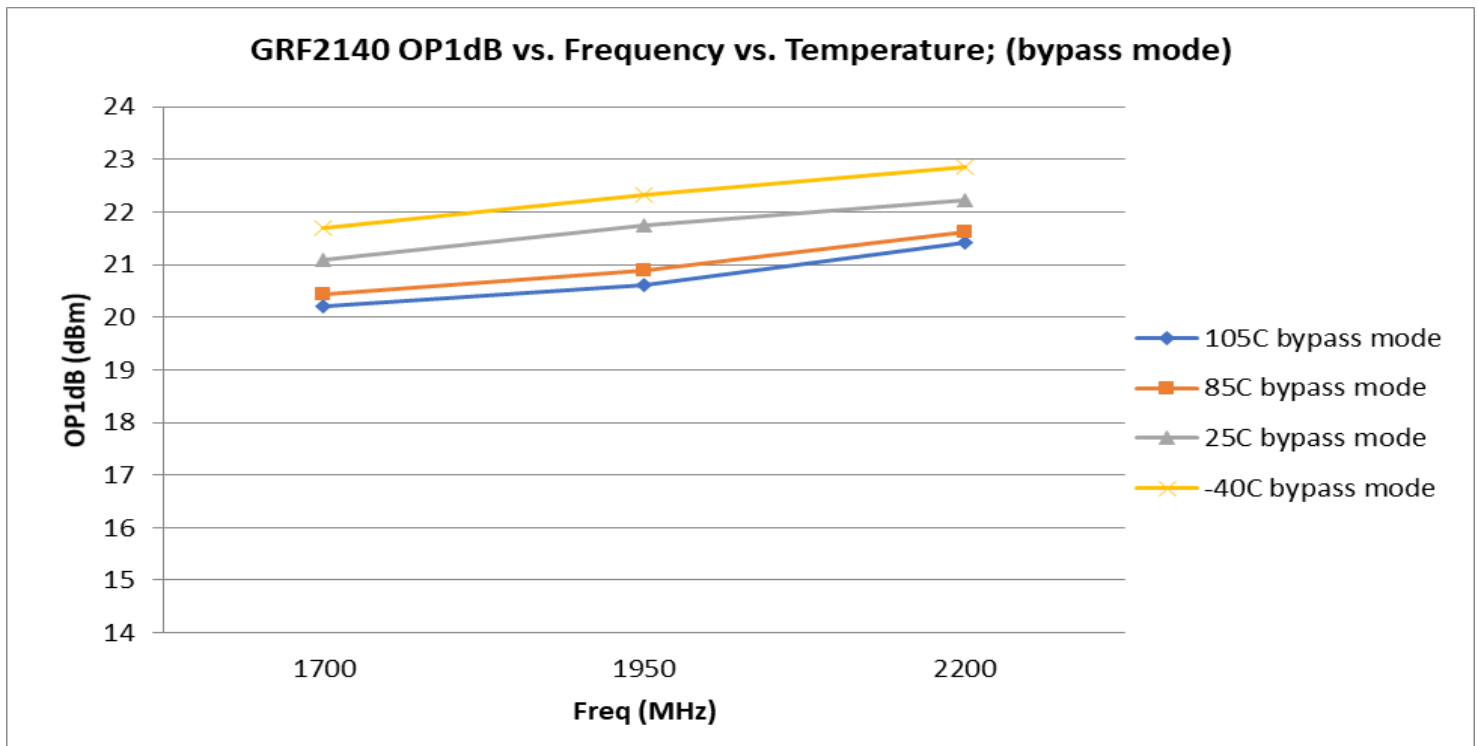
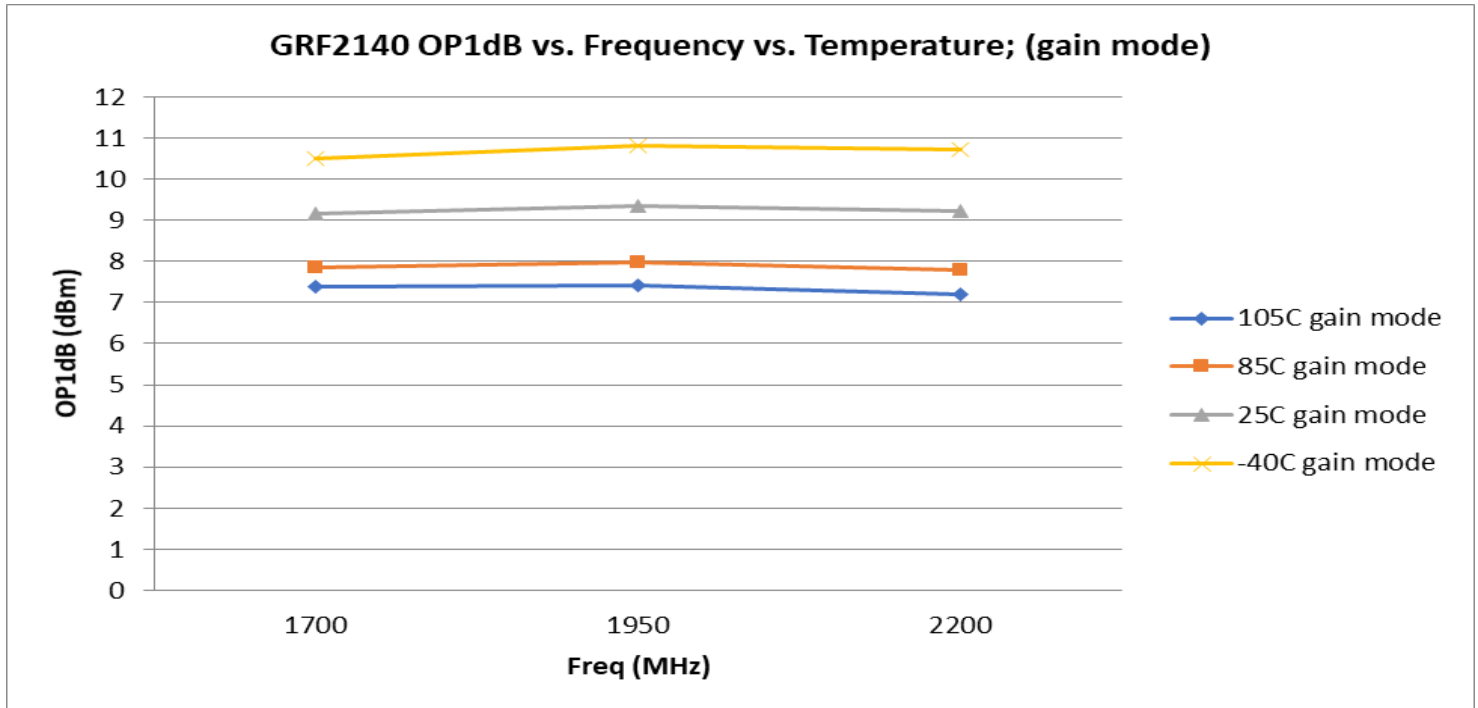

GRF2140 Evaluation Board Measured Data in Gain and Bypass Modes:

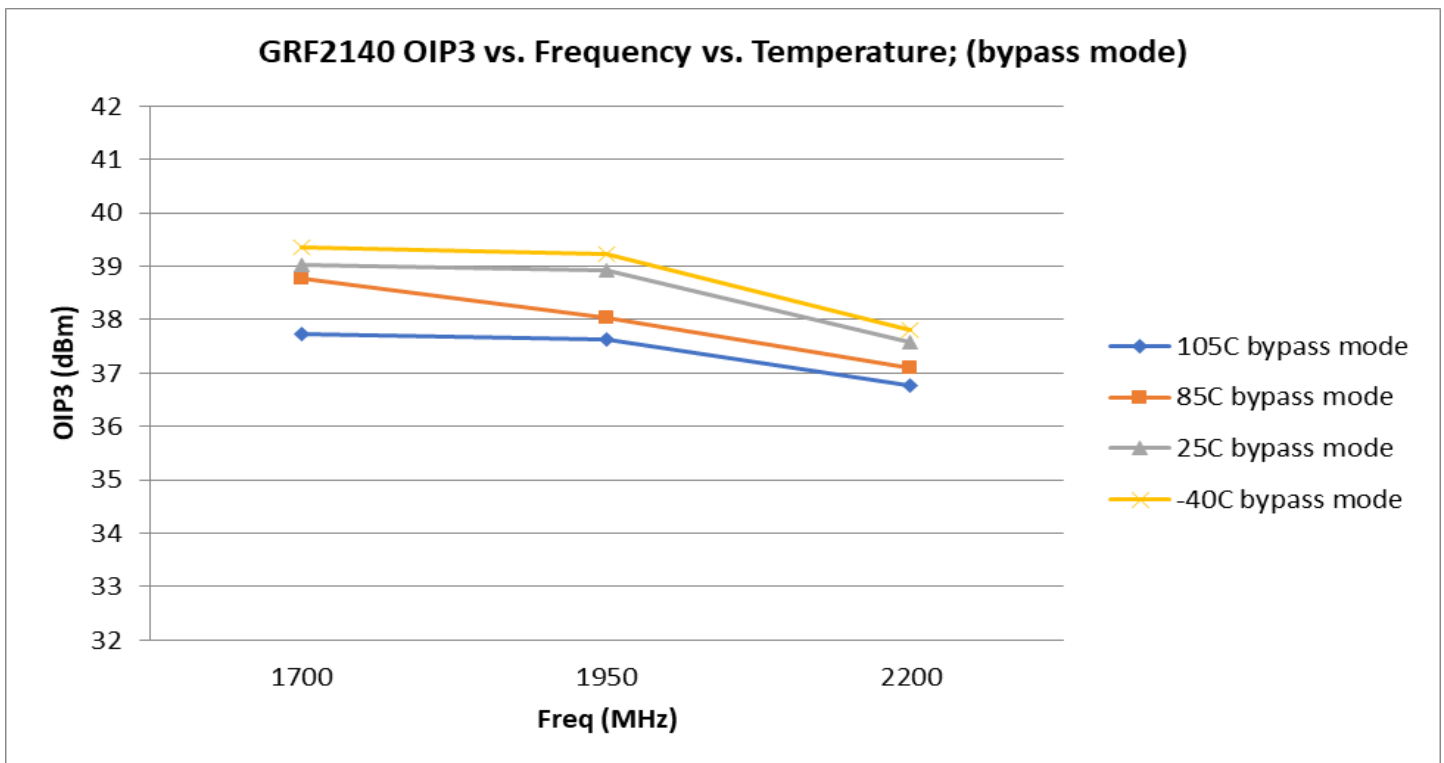
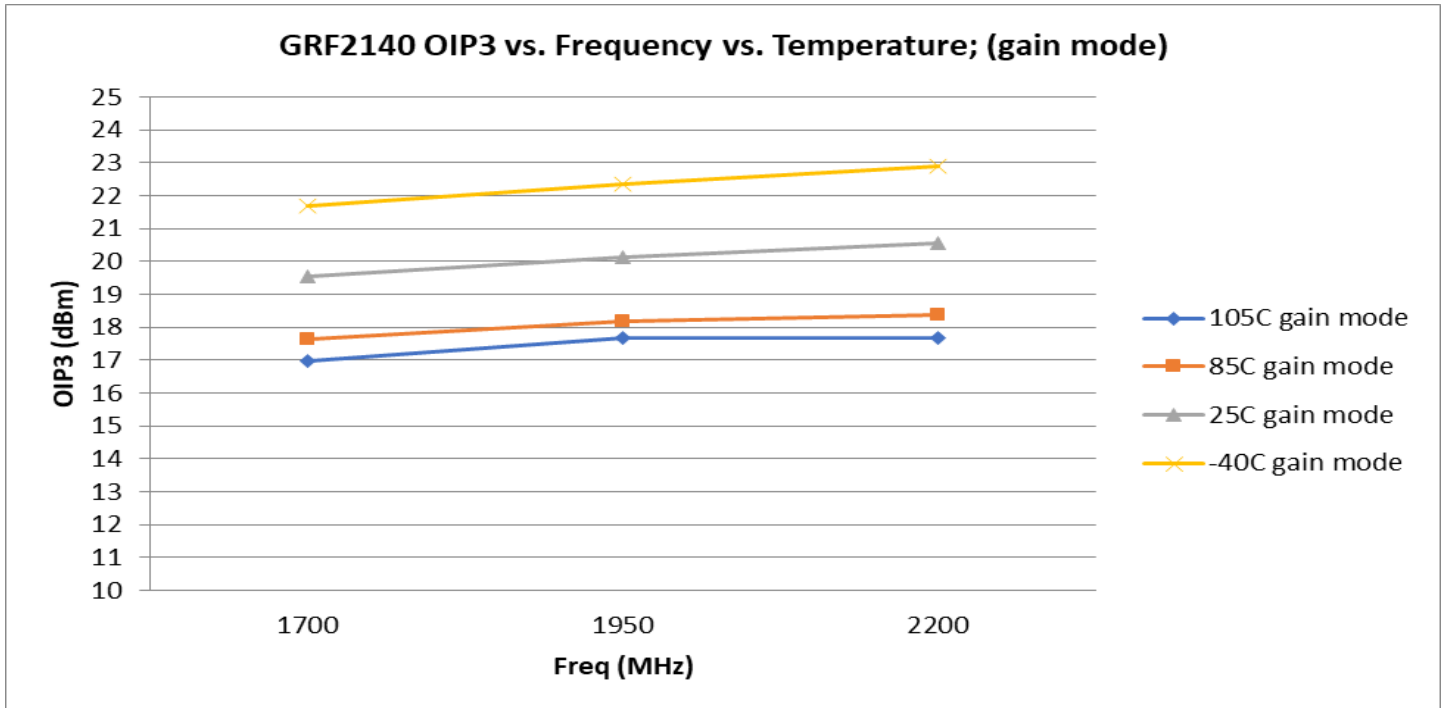





Released

# GRF2140

Low Current LNA w/Bypass  
Tuning Range: 0.1 to 3.8 GHz

## GRF2140 Evaluation Board S-Pars (Gain Mode) with 1.7 to 2.2 GHz Tune:





Released

# GRF2140

Low Current LNA w/Bypass  
Tuning Range: 0.1 to 3.8 GHz

## GRF2140 Evaluation Board Stability Mu Factor:

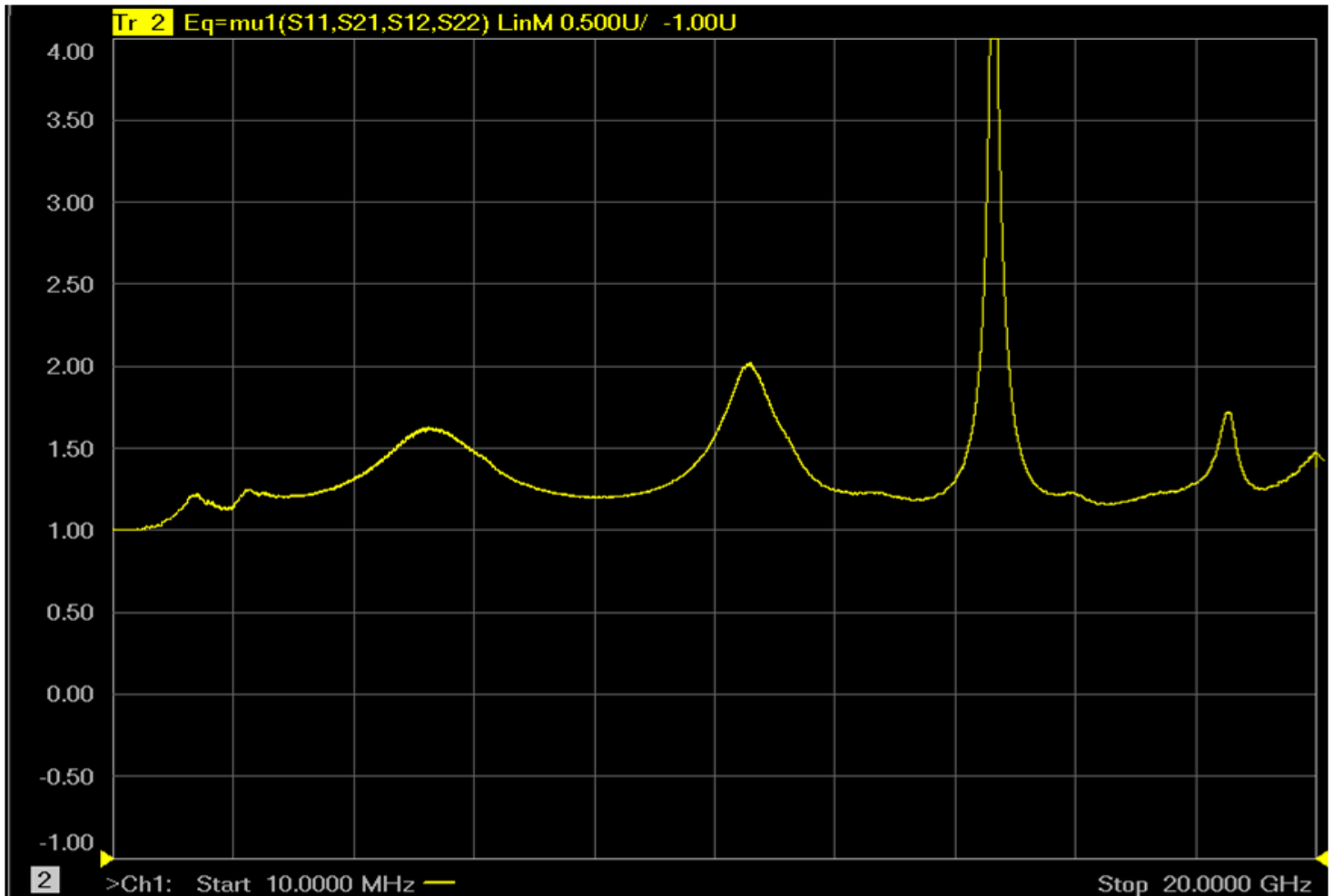

Note: Mu factor  $\geq 1.0$  implies unconditional stability.

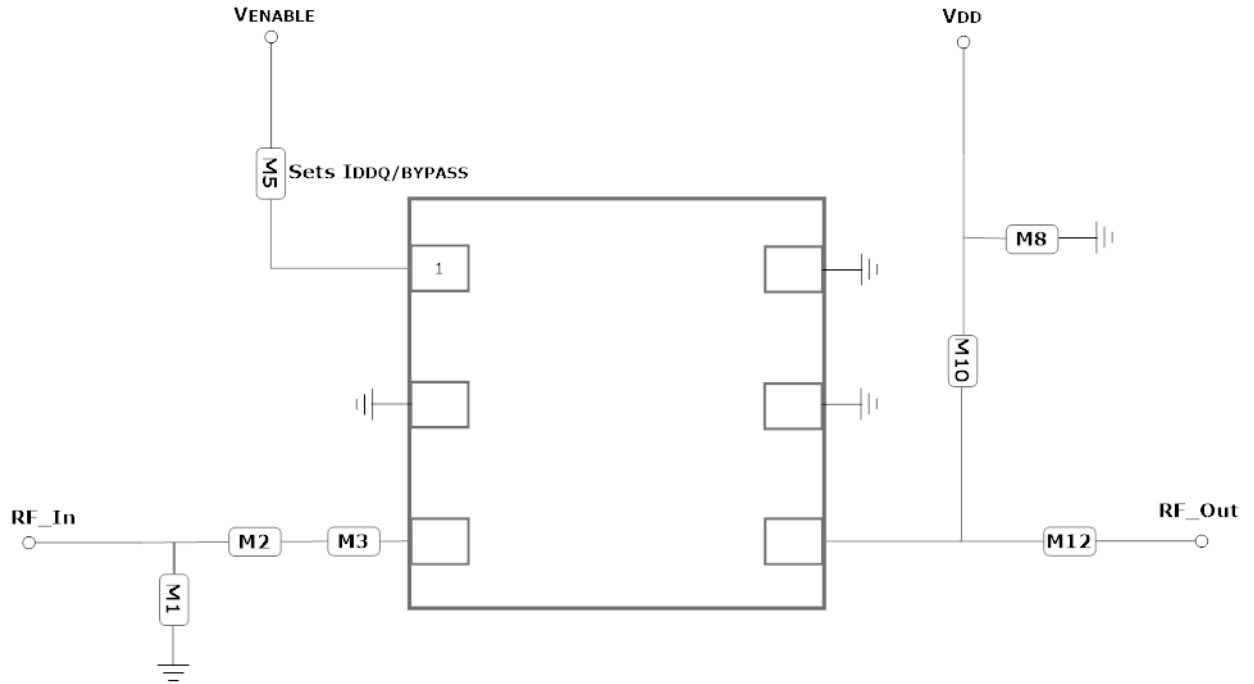

GRF2140 Application Schematic (1.7 to 2.2 GHz)

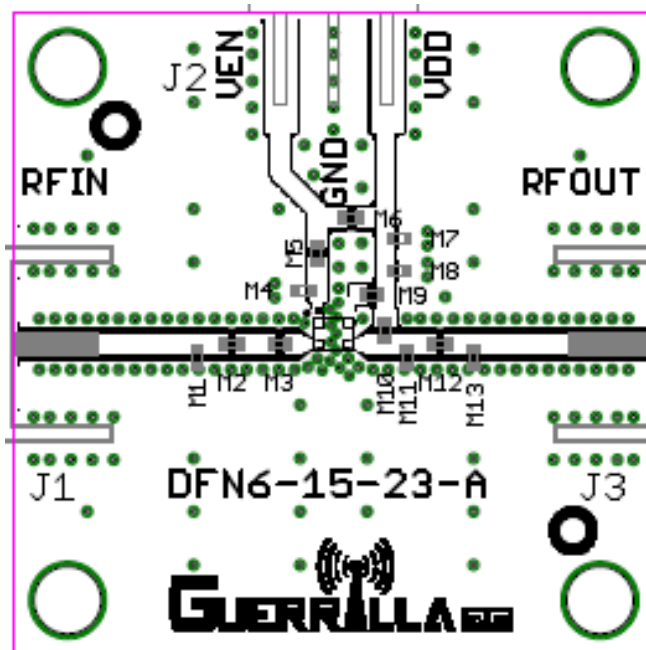

GRF2140 Evaluation Board Assembly Diagram



Released

# GRF2140

Low Current LNA w/Bypass  
Tuning Range: 0.1 to 3.8 GHz

## GRF2140 Standard Evaluation Board BOM: (1.7 to 2.2 GHz Tune)

Component	Type	Manufacturer	Family	Value	Package Size	Substitution
M1	Inductor	Murata	LQP	3.9 nH	0402	Yes
M2	Capacitor	Murata	GJM	30 pF	0402	Yes
M3	Inductor	Murata	LQP	1.5 nH	0402	Yes
M5 (see curves)	Resistor	Various	—	TBD	0402	Yes
M8	Capacitor	Murata	GRM	0.1 uF	0402	Yes
M10	Inductor	Murata	LQP	3.3 nH	0402	Yes
M12	Capacitor	Murata	GJM	2.2 pF	0402	Yes
Evaluation Board:	DFN6-15-23-A					

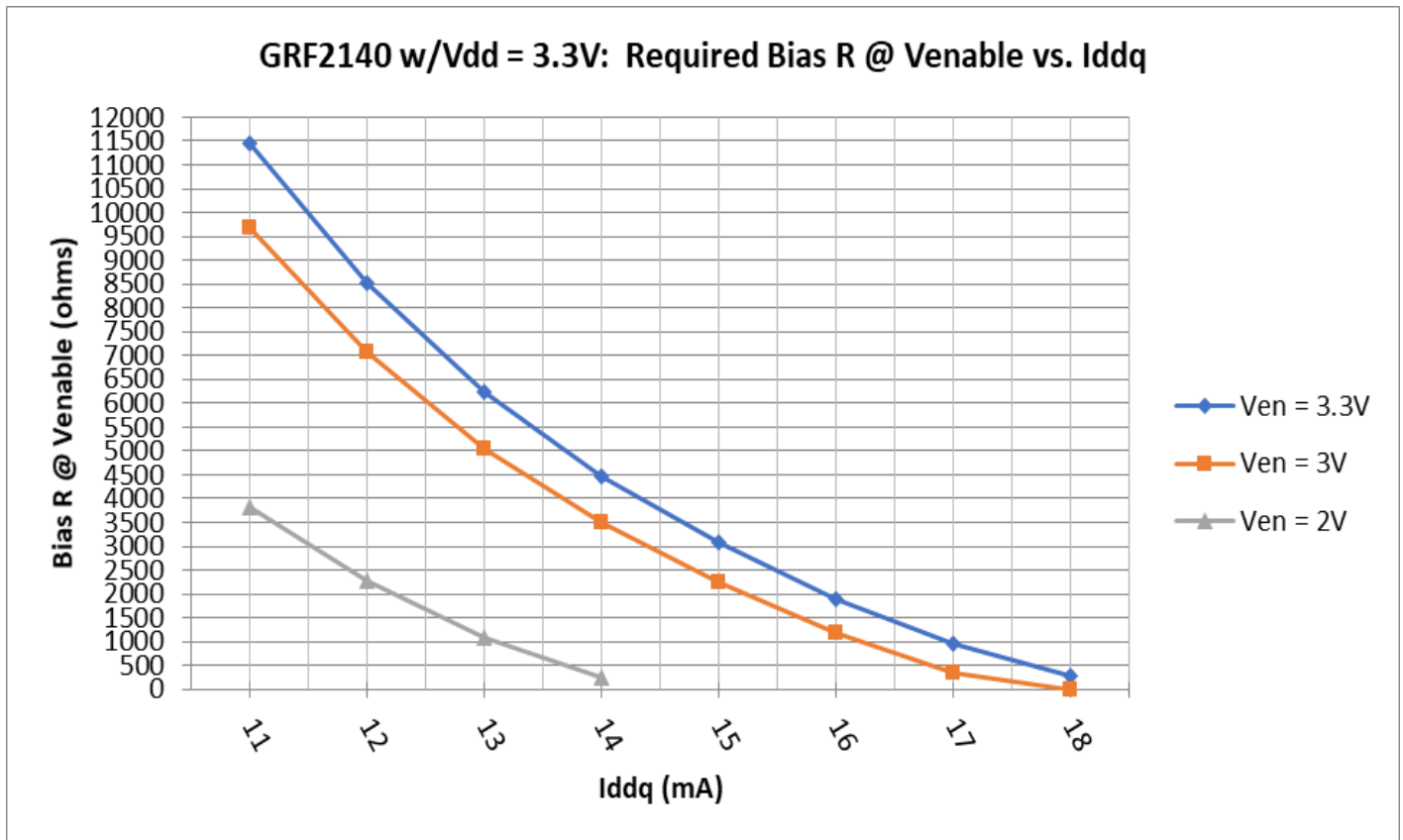

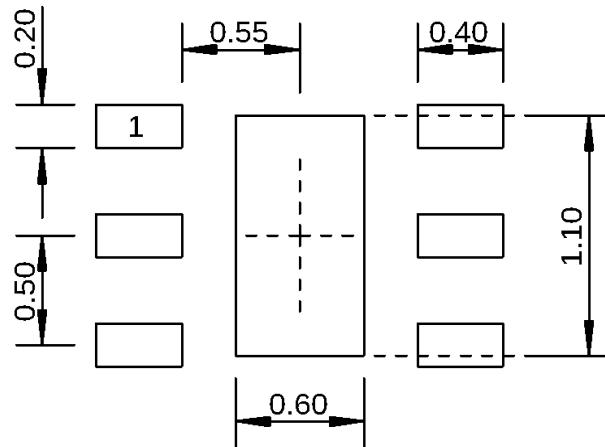

Dimensions in millimeters

### 1.5 mm DFN-6 Suggested PCB Footprint (Top View)

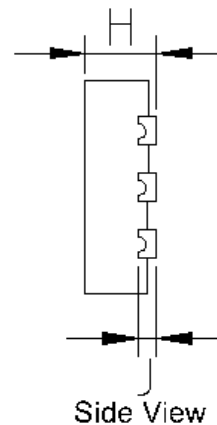
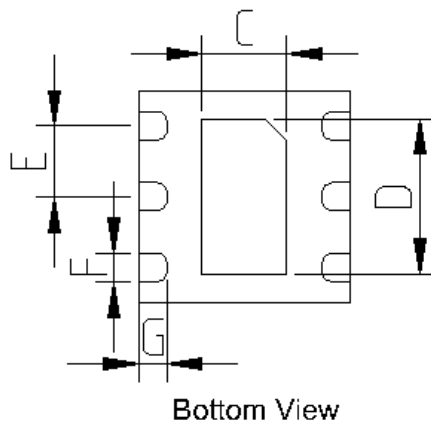
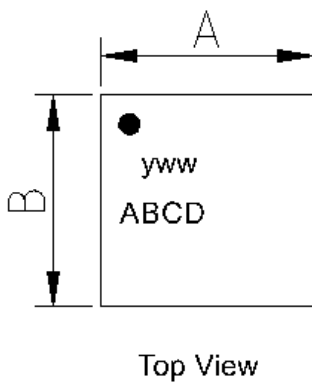

Dimensions (MM)	
A	1.5 +/- 0.050
B	1.5 +/- 0.050
C	.6 +/- 0.050
D	1.1 +/- 0.050
E	.5 Bsc
F	.2 +/- 0.050
G	.2 +/- 0.050
H	.45 +/- 0.050
J	.12 Ref.

### 1.5 mm DFN-6 Package Dimensions

### Tape and Reel Information:

Guerrilla RF's Tape and Reel specification complies with the Electronics Industries Association (EIA) standards for 'Embossed Carrier Tape of Surface Mount Components for Automatic Handling'. Reference EIA-481. See the table on the following page for Tape and Reel specifications along with units per reel.

Devices are loaded with pins down into the carrier pocket with protective cover tape, wound into a plastic reel. Each reel will be packaged in a cardboard box. There will be product labels on the reel, the protective ESD bag and the outside surface of the box.

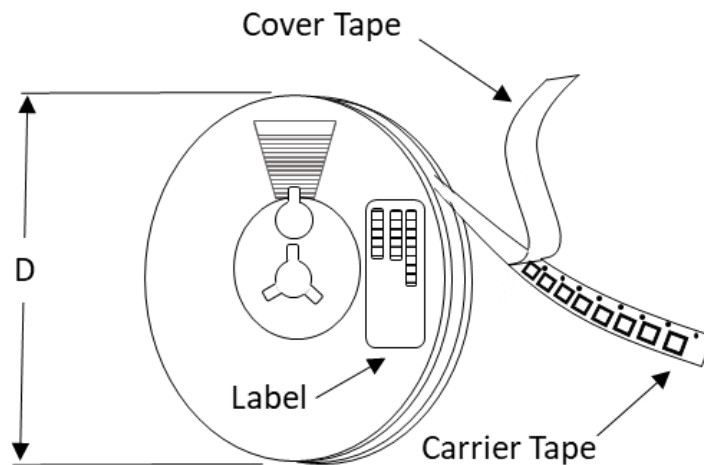

Tape and Reel Packaging with Reel Diameter Noted (D)

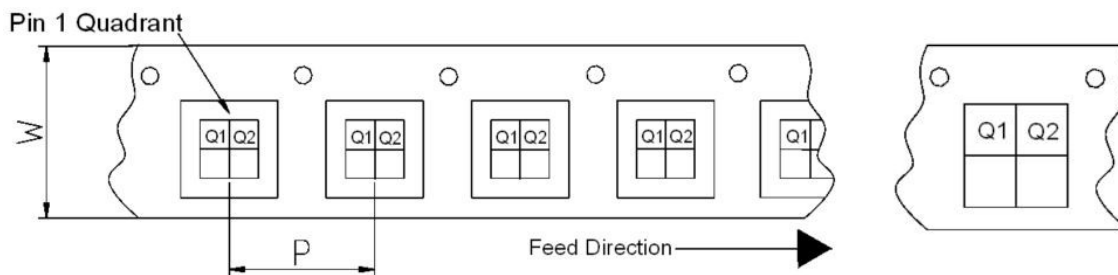

Carrier Tape Width (W), Pitch (P), Feed Direction and Pin 1 Quadrant Information



Released

# GRF2140

Low Current LNA w/Bypass  
Tuning Range: 0.1 to 3.8 GHz

Tape and Reel Specification and Device Package Information Table

Package				Carrier Tape			Reel	
Type	Dimensions (mm)	Leads	Weight (mg)	Width (W) (mm)	Pocket Pitch (P) (mm)	Pin 1 Quadrant	Diameter (D) (inches)	Units per Reel
QFN	2.0 x 2.0 x 0.50	12	7	8	4	Q1	7	2500
QFN	3.0 x 3.0 x 0.85	16	24	12	8	Q1	7	1500
DFN	1.5 x 1.5 x 0.45	6	4	8	4	Q1	7	2500
DFN	2.0 x 2.0 x 0.75	8	12	8	4	Q1	7	2500
LFM	3.5 x 3.5 x 0.75	See note	TBD	12	8	Q2	7	1500
LFM	4.0 x 4.0 x 0.75	See note	TBD	12	8	Q2	7	1500

Note: Lead count may vary. Reference applicable product data sheet



Released

# GRF2140

Low Current LNA w/Bypass  
Tuning Range: 0.1 to 3.8 GHz

Data Sheet Release Status:	Notes
Advance	S-parameter and NF data based on EM simulations for the fully packaged device using foundry supplied transistor s-parameters. Linearity estimates based on device size, bias condition and experience with related devices.
Preliminary	All data based on evaluation board measurements in the Guerrilla RF Applications Lab.
Released	All data based on device qualification data. Typically, this data is nearly identical to the data found in the preliminary version. Max and min values for key RF parameters are included.

Information in this datasheet is specific to the Guerrilla RF, Inc. ("Guerrilla RF") product identified.

This datasheet, including the information contained in it, is provided by Guerrilla RF as a service to its customers and may be used for informational purposes only by the customer. Guerrilla RF assumes no responsibility for errors or omissions on this datasheet or the information contained herein. Information provided is believed to be accurate and reliable, however, no responsibility is assumed by Guerrilla RF for its use, nor for any infringement of patents, or other rights of third parties, resulting from its use. Guerrilla RF assumes no liability for any datasheet, datasheet information, materials, products, product information, or other information provided hereunder, including the sale, distribution, reproduction or use of Guerrilla RF products, information or materials.

No license, whether express, implied, by estoppel, by implication or otherwise is granted by this datasheet for any intellectual property of Guerrilla RF, or any third party, including without limitation, patents, patent rights, copyrights, trademarks and trade secrets. All rights are reserved by Guerrilla RF.

All information herein, products, product information, datasheets, and datasheet information are subject to change and availability without notice. Guerrilla RF reserves the right to change component circuitry, recommended application circuitry and specifications at any time without prior notice. Guerrilla RF may further change its datasheet, product information, documentation, products, services, specifications or product descriptions at any time, without notice. Guerrilla RF makes no commitment to update any materials or information and shall have no responsibility whatsoever for conflicts, incompatibilities, or other difficulties arising from any future changes.

GUERRILLA RF INFORMATION, PRODUCTS, PRODUCT INFORMATION, DATASHEETS AND DATASHEET INFORMATION ARE PROVIDED "AS IS" AND WITHOUT WARRANTY OF ANY KIND, WHETHER EXPRESS, IMPLIED, STATUTORY, OR OTHERWISE, INCLUDING FITNESS FOR A PARTICULAR PURPOSE OR USE, MERCHANTABILITY, PERFORMANCE, QUALITY OR NON-INFRINGEMENT OF ANY INTELLECTUAL PROPERTY RIGHT; ALL SUCH WARRANTIES ARE HEREBY EXPRESSLY DISCLAIMED. GUERRILLA RF DOES NOT WARRANT THE ACCURACY OR COMPLETENESS OF THE INFORMATION, TEXT, GRAPHICS OR OTHER ITEMS CONTAINED WITHIN THESE MATERIALS. GUERRILLA RF SHALL NOT BE LIABLE FOR ANY DAMAGES, INCLUDING BUT NOT LIMITED TO ANY SPECIAL, INDIRECT, INCIDENTAL, STATUTORY, OR CONSEQUENTIAL DAMAGES, INCLUDING WITHOUT LIMITATION, LOST REVENUES OR LOST PROFITS THAT MAY RESULT FROM THE USE OF THE MATERIALS OR INFORMATION, WHETHER OR NOT THE RECIPIENT OF MATERIALS HAS BEEN ADVISED OF THE POSSIBILITY OF SUCH DAMAGE.

Customers are solely responsible for their use of Guerrilla RF products in the Customer's products and applications or in ways which deviate from Guerrilla RF's published specifications, either intentionally or as a result of design defects, errors, or operation of products outside of published parameters or design specifications. Customers should include design and operating safeguards to minimize these and other risks. Guerrilla RF assumes no liability or responsibility for applications assistance, customer product design, or damage to any equipment resulting from the use of Guerrilla RF products outside of stated published specifications or parameters.



# Mouser Electronics

Authorized Distributor

Click to View Pricing, Inventory, Delivery & Lifecycle Information:

[Guerrilla RF:](#)

[GRF2140](#) [GRF2140-EVB](#)