

Description

Very cost effective design to meet international requirements. No exposed metal parts which are, or could become, current-carrying except for terminals. R-type TO CBE to EN 60934.

- Manual reset, cycling trip free mechanism
- Extremely small and lightweight
- UL, CSA, VDE and EN 60934 (IEC 60934) approved

Typical applications

Battery chargers, consumer products, power supplies, motors.

Ordering information

Type No.

1658 single pole thermal circuit breaker

Threadneck design

G21 manual reset type, 3/8"-27 threadneck

A00 auto reset type, without threadneck

Hardware

00 no hardware

01 one PAL nut Y306 671 01, bulk

02 one PAL nut Y306 671 01,
one knurled nut Y307 117 02, bulk

Terminals

P10 blade terminals A6.3-0.8 (QC .250)

P13 blade terminals A6.3-0.8 (QC .250), 90°

Current ratings

5...30 A

1658 - G21 - 02 - P10 - 5 A Ordering example

* Screws and lock washers bulk shipped

Please be informed that we have minimum ordering quantities to be observed.

Preferred types

Preferred types	Standard current ratings (A)											
	5	6	7	8	9	10	12	15	16	20	25	30
1658-G21-02-P10-	x	x	x	x	x	x	x	x	x	x	x	x
1658-G21-02-P13-	x	x	x	x	x	x	x	x	x			
1658-A00-00-P10-	x	x	x	x	x	x	x	x	x			

Standard current ratings and typical voltage drop values

Current rating (A)	voltage drop values (mV)	Current rating (A)	voltage drop values (mV)
5	≤ 250	12	≤ 250
6	≤ 250	15	≤ 250
7	≤ 250	16	≤ 250
8	≤ 250	20	≤ 250
9	≤ 250	25	≤ 250
10	≤ 250	30	≤ 250



1658-...

Technical data

For further details please see: http://www.e-t-a.de/ti_e

Voltage rating	AC 240 V; DC 28 V		
Current ratings	5...30 A		
Typical life	AC + DC	5...16 A	1,000 operations at 2 x I _N , inductive
		17...25 A	1,000 operations at 2 x I _N , resistive
Behaviour at rated switching capacity (EN 60934; test sequence D)	operat.	I _N	U _N
	40	5...16 A	AC 240 V 6 x I _N ind
	40	5...16 A	DC 28 V 4 x I _N ind
	40	17...25 A	AC 240 V 120 A resistive
	40	17...25 A	DC 28 V 120 A resistive
Ambient temperature	-20...+60 °C (-4...+140 °F), ≤ 7 A max. +40 °C (+104 °F)		
Insulation co-ordination (IEC 60664 and 60664 A)	rated impulse withstand voltage	2.5 kV	pollution degree 2 reinforced insulation in operating area
Dielectric strength (IEC 60664 and 60664A)	test voltage operating area	AC 3,000 V	
Insulation resistance	> 100 MΩ (DC 500 V)		
Interrupting capacity I _{cn}	5...7 A	180 A	
	8...30 A	200 A	
Interrupting capacity (UL 1077/EN 60934 PC1)	I _N	U _N	
	5...16 A	AC 240 V	1 000 A, C, 1
	5...30 A	AC 125 V	2 000 A, C, 1
	5...30 A	DC 32 V	2 000 A, C, 1
	5...30 A	AC 125 V	2 000 A, C, 1
		DC 28 V	(1658-A...)
Degree of protection (IEC 60529/DIN 40050)	operating area IP40 terminal area IP00		
Vibration	8 g (57-500 Hz) ± 0.61 mm (10-57 Hz), to IEC 60068-2-6, test Fc, 10 frequency cycles/axis		
Shock	30 g (11 ms) to IEC 60068-2-27, test Ea		
Corrosion	96 hours at 5 % salt mist, to IEC 60068-2-11, test Ka		
Humidity	240 hours at 95 % RH to IEC 60068-2-78, test Cab		
Mass	approx. 16 g		

Dimensions

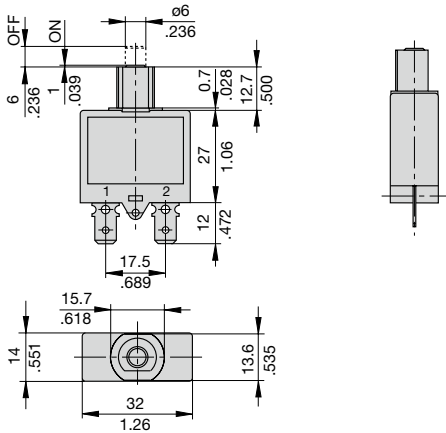

A00



G21 tightening torque max. 0.8 Nm
3/8-27UNS-2A

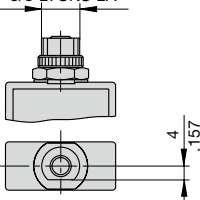

See ordering information for mounting hardware.

Terminal design

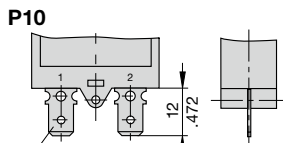

blade terminals DIN 46244-A6.3-0.8
(QC .250)

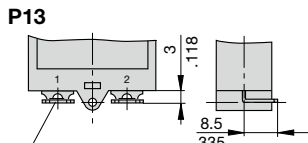

blade terminals DIN 46244-A6.3-0.8 (QC .250)
angled 90°

Installation drawing

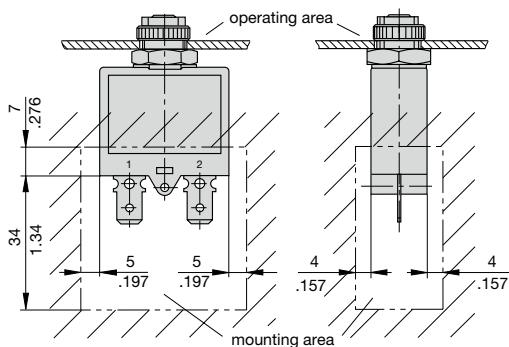

Internal connection diagram

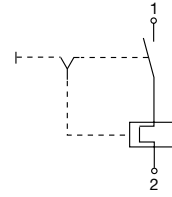

Typical time/current characteristics

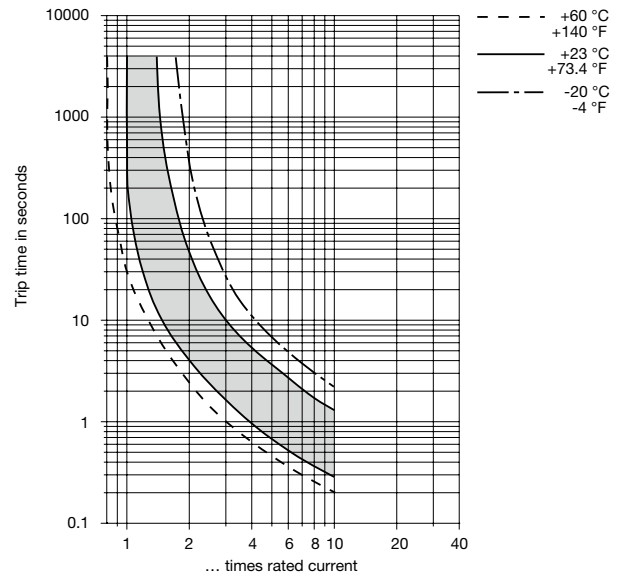

The time/current characteristic curve depends on the ambient temperature prevailing. In order to eliminate nuisance tripping, please multiply the circuit breaker current ratings by the derating factor shown below. See also section Technical information.

Ambient temp. °F	-4	+14	+32	+73.4	+104	+122	+140
Ambient temp. °C	-20	-10	0	+23	+40	+50	+60
Derating factor $I_N > 7A$	0.83	0.85	0.9	1	1.1	1.18	1.25
Derating factor $I_N < 7A$	0.74	0.76	0.82	1	1.23	-	-

This is a metric design and millimeter dimensions take precedence ($\frac{\text{mm}}{\text{inch}}$)

Accessories

PAL nut 3/8", 27-thread
Y 306 671 01

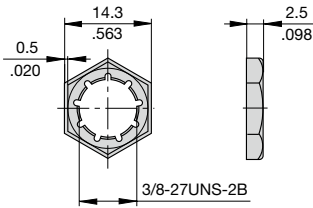

Knurled nut 3/8", 27-thread plastic (standard)
Y 307 117 02

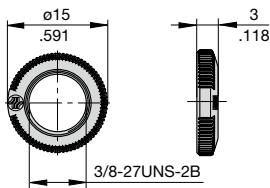

Knurled nut 3/8", 27-thread nickel-plated brass
Y 300 190 03

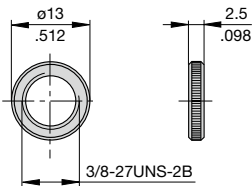

Hex nut 3/8", 27-thread nickel-plated brass
Y 300 192 01

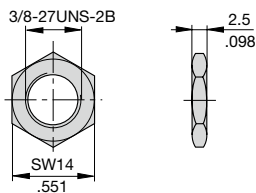

Press to Reset Plate for 3/8" thread, aluminium
Y 301 059 02

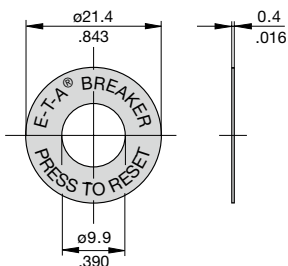

Reset button seal for 3/8", 27-thread, short
X 201 285 01 (IP64)

long
X 200 799 01 (IP64)

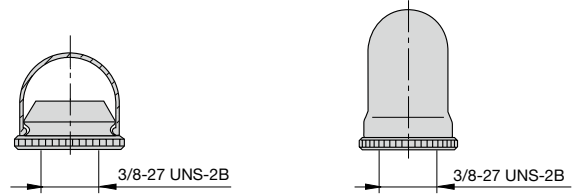

Panel cut out

1658-3/8-27 UNS-2A

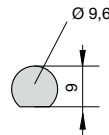

Approvals

Authority	Standard	Rated voltage	Current ratings	Approval mark
1658-G				
VDE	IEC/EN 60934	AC 240 V DC 28 V	5 A...25 A 5 A...25 A	
UL	UL 1077 CSA C22.2 No 235 UL 1500 Ignition Protected	AC 240 V DC 32 V	5 A...30 A 5 A...30 A	
CSA	CSA C22.2 No 235	AC 240 V DC 32 V	5 A...30 A 5 A...30 A	
1658-A				
VDE	IEC/EN 60934	AC 240 V DC 28 V	5 A...25 A 5 A...25 A	
UL	UL 244A	AC 125 V DC 28 V	5 A...30 A 5 A...30 A	

This is a metric design and millimeter dimensions take precedence $\left(\frac{\text{mm}}{\text{inch}}\right)$

All dimensions without tolerances are for reference only. In the interest of improved design, performance and cost effectiveness the right to make changes in these specifications without notice is reserved. Product markings may not be exactly as the ordering codes. Errors and omissions excepted.

Mouser Electronics

Authorized Distributor

Click to View Pricing, Inventory, Delivery & Lifecycle Information:

E-T-A Circuit Breakers:

[1658-G21-01-P10-30A](#) [1658-G21-01-P10-5A](#) [1658-G21-01-P10-25A](#) [1658-G21-01-P10-15A](#) [1658-G21-01-P10-17A](#)
[1658-G21-00-P10-7A](#) [1658-G21-02-P10-9A](#) [1658-G21-00-P13-20A](#) [1658-G21-00-P10-15A](#) [1658-G21-00-P10-10A](#)
[1658-G21-00-P10-5A](#) [1658-G21-01-P10-20A](#) [1658-G21-02-P10-15A](#) [1658-G21-00-P10-20A](#) [1658-G21-00-P10-9A](#)
[1658-G21-02-P10-5A](#) [1658-A00-00-P10-6A](#) [1658-A00-00-P10-8A](#) [1658-G21-00-P10-12A](#) [1658-A00-00-P10-12A](#)
[1658-G21-00-P10-16A](#) [1658-G21-01-P10-8A](#) [1658-G21-02-P13-15A](#) [1658-G21-01-P10-18A](#) [1658-G21-00-P10-8A](#)
[1658-G21-02-P10-6A](#) [1658-A00-00-P13-10A](#) [1658-G21-00-P10-30A](#) [1658-G21-00-P10-35A](#) [1658-A00-00-P13-5A](#)
[1658-G21-01-P10-35A](#) [1658-G21-01-P13-10A](#) [1658-G21-02-P10-7A](#) [1658-G21-00-P10-25A](#) [1658-A00-00-P10-15A](#)
[1658-G21-02-P10-20A](#) [1658-G21-01-P13-20A](#) [1658-G21-02-P10-10A](#) [1658-G21-02-P10-8A](#) [1658-A00-00-P10-5A](#)
[1658-G21-02-P10-13A](#) [1658-G21-00-P13-8A](#) [1658-A00-00-P10-10A](#) [1658-G21-00-P13-6A](#) [1658-G21-01-P10-12A](#)
[1658-G21-00-P10-6A](#) [1658-G21-02-P10-12A](#) [1658-G21-02-P13-6A](#) [1658-G21-02-P10-16A](#) [1658-G21-01-P10-6A](#)
[1658-G21-00-P10-18A](#) [1658-G21-01-P10-16A](#) [1658-G21-00-P13-15A](#) [1658-A00-00-P10-30A](#) [1658-A00-00-P13-30A](#)
[1658-G21-01-P10-10A](#) [1658-G21-01-P13-15A](#) [1658-A00-00-P10-25A](#) [1658-G21-02-P13-8A](#) [1658-G21-02-P10-30A](#)
[1658-G21-02-P10-35A](#) [1658-G21-01-P10-7A](#) [1658-G21-00-P10-13A](#) [1658-G21-00-P13-10A](#) [1658-G21-02-P10-25A](#)
[1658-G21-00-P10-17A](#) [1658-A00-00-P10-20A](#) [1658-G21-02-P10-055800-12A](#) [1658-G21-00-P10-055810-15A](#) [1658-G21-00-P10-055800-7A](#)
[1658-G21-00-P13-D01-10A](#) [1658-G21-00-P10-D01-055810-15A](#) [1658-G21-00-P13-055800-8A](#) [1658-G21-00-P10-D01-10A](#) [1658-G21-02-P10-055800-20A](#) [1658-G21-00-P10-D01-7A](#) [1658-G21-01-P10-D01-055810-5A](#)
[1658-G21-00-P10-055800-25A](#) [1658-G21-00-P10-055809-10A](#) [1658-G21-00-P10-055800-15A](#) [1658-G21-00-P10-055810-10A](#) [1658-G21-00-P10-D04-8A](#) [1658-G21-00-P10-055809-17A](#) [1658-G21-00-P10-055801-17A](#) [1658-G21-00-P10-D01-055810-20A](#) [1658-G21-00-P10-D01-30A](#) [1658-G21-00-P10-D01-25A](#) [1658-G21-00-P10-055800-12A](#)
[1658-G21-01-P10-055800-20A](#) [1658-G21-00-P10-055801-25A](#) [1658-G21-01-P10-D01-7A](#) [1658-G21-02-P10-055800-15A](#) [1658-G21-00-P10-D01-055810-5A](#) [1658-G21-01-P10-D01-15A](#) [1658-G21-00-P10-055800-20A](#) [1658-G21-01-P10-D01-5A](#) [1658-G21-01-P10-D04-8A](#) [1658-G21-00-P10-055800-6A](#) [1658-G21-00-P10-D01-5A](#) [1658-G21-01-P10-D01-055810-15A](#)

Mouser Electronics

Authorized Distributor

Click to View Pricing, Inventory, Delivery & Lifecycle Information:

E-T-A Circuit Breakers:

[Y30019201](#) [Y30711702](#) [Y30019003](#) [Y30667101](#)