

Features

- 1.4 dB Noise Figure
- 35 dBm Output IP₃
- Single +3 V Bias
- Lead-Free SC70 6-Lead (SOT-363) Package
- Halogen-Free “Green” Mold Compound
- RoHS* Compliant

Description

The MAAL-009053 broadband gain block is a GaAs MMIC amplifier in a lead-free SC70-6LD (SOT-363) surface mount plastic package. The topology is a monolithic single stage self-biased design featuring a convenient 50 Ω input / output impedance that minimizes the number of external components.

The MAAL-009053 is fabricated using a pHEMT process to help realize the complementary high IP3 and low NF. This process features full passivation for performance and reliability.

Ordering Information¹

Part Number	Package
MAAL-009053-000000	Bulk Packaging
MAAL-009053-TR3000	3000 piece reel

1. Reference Application Note M513 for reel size information.

Functional Schematic

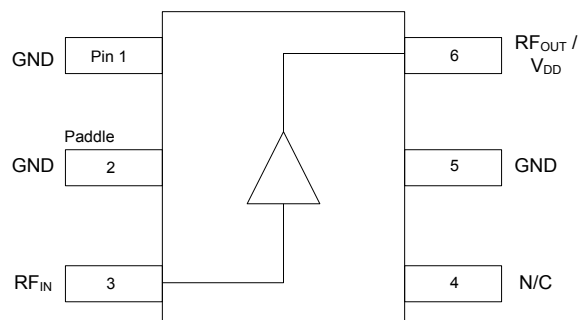

Pin Configuration²

Pin No.	Function	Description
1	GND	Ground
2	GND	Ground
3	RF _{IN}	RF Input
4	N/C	No Connection
5	GND	Ground
6 ³	RF _{OUT} /V _{DD}	RF Output / Drain Voltage

2. MACOM recommends connecting unused package pins to ground.
3. Series inductor and decoupling capacitor recommended on pin 6.

* Restrictions on Hazardous Substances, European Union Directive 2011/65/EU.

Electrical Specifications: $T_A = +25^\circ\text{C}$, $V_{DD} = +3\text{ V}$, $Z_0 = 50\ \Omega$

Parameter	Test Conditions	Units	Bias Voltage			
			3 Volts			5 Volts ⁸
			Min.	Typ.	Max.	Typ.
Gain	0.9 GHz 1.9 GHz	dB	— 10.4	14.0 11.0	— 13.0	14.5 11.2
Noise Figure	0.9 GHz 1.9 GHz	dB	—	1.4 1.4	— 1.8	1.5 1.5
Input Return Loss	0.9 GHz 1.9 GHz	dB	—	7 11	—	7 11
Output Return Loss	0.9 GHz 1.9 GHz	dB	—	22 20	—	26.0 18.5
Output P1dB	900 - 1900 MHz	dBm	—	18.5	—	—
Output IP ₃	900 - 1900 MHz	dBm	—	35	—	35
Current	—	mA	60	80	100	95

Absolute Maximum Ratings^{4,5}

Parameter	Absolute Maximum
Gain Compression	6 dB
Voltage	5.5 V
Junction Temperature ^{6,7}	+150°C
Operating Temperature	-40°C to +85°C
Storage Temperature	-65°C to +150°C

4. Exceeding any one or combination of these limits may cause permanent damage to this device.
5. MACOM does not recommend sustained operation near these survivability limits.
6. Operating at nominal conditions with $T_J \leq 150^\circ\text{C}$ will ensure $\text{MTTF} > 1 \times 10^6$ hours.
7. Junction Temperature (T_J) = Case Temperature (T_C) + $\Theta_{JC} \cdot P$
Typical thermal resistance (Θ_{JC}) = 131°C/W
 - a) For $T_C = +25^\circ\text{C}$,
 $T_J = 56^\circ\text{C} @ 3\text{ V}, 80\text{ mA}$
 - b) For $T_C = +85^\circ\text{C}$,
 $T_J = 116^\circ\text{C} @ 3\text{ V}, 80\text{ mA}$

Handling Procedures

Please observe the following precautions to avoid damage:

Static Sensitivity

These electronic devices are sensitive to electrostatic discharge (ESD) and can be damaged by static electricity. Proper ESD control techniques should be used when handling these HBM class 1A devices.

Satellite TV Amplifier 800 - 3000 MHz

Rev. V9

800 - 3000 MHz, Recommended PCB Configuration

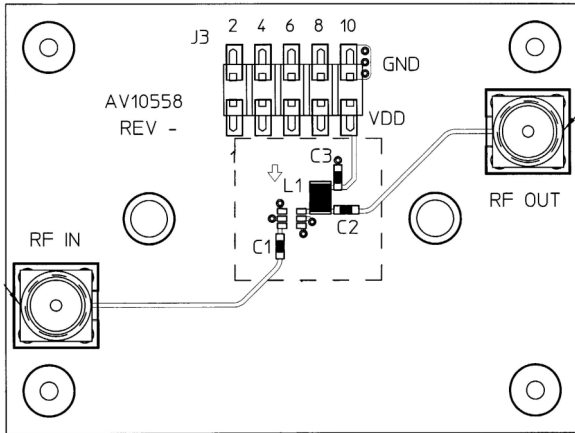

800 - 3000 MHz, Application Schematic

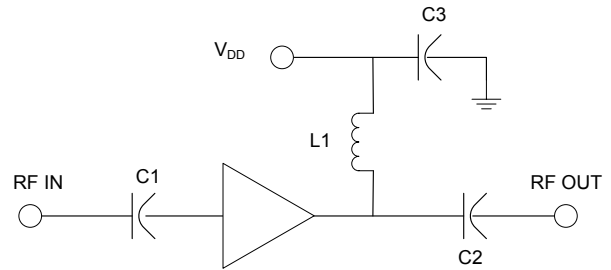

800 - 3000 MHz, Component List

Part	Value	Case Style	Purpose
C1	39 pF	0402	Input DC Block
C2	39 pF	0402	Output DC Block
C3	470 pF	0402	RF Bypass
L1	12 nH	0805	RF Choke/Tuning

Lead-Free SC-70 6-Lead (SOT-363)[†]

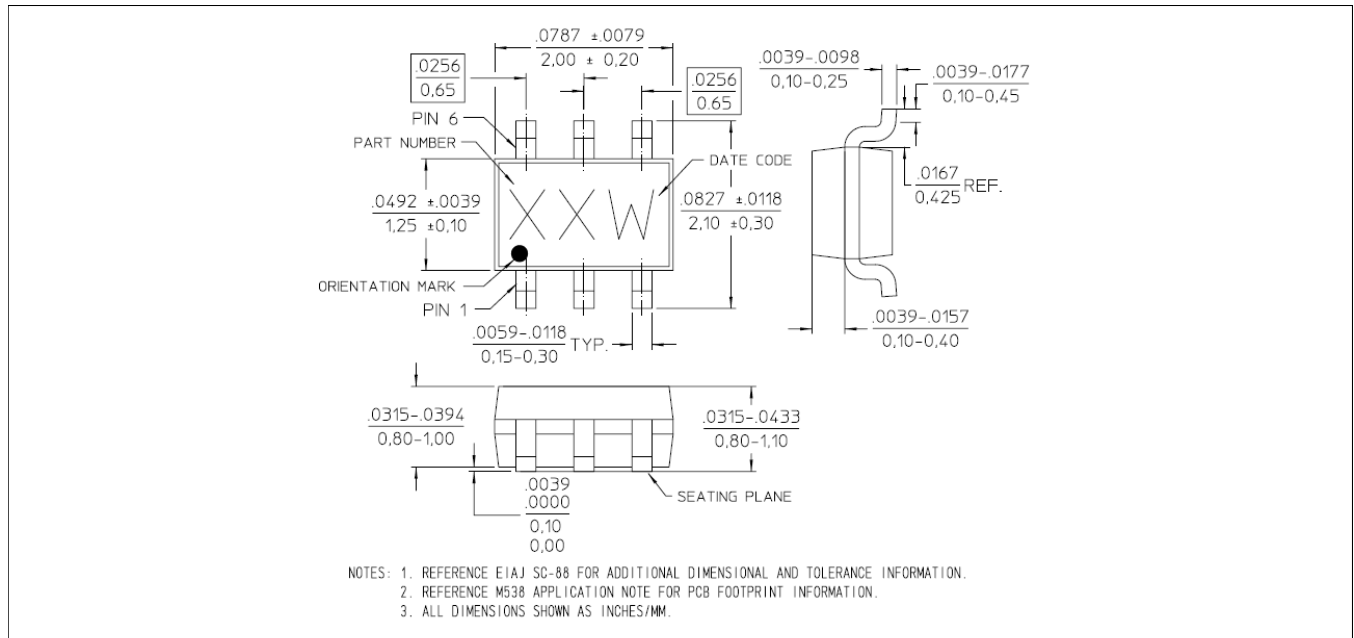

[†] Reference Application Note M538 for lead-free solder reflow recommendations.
Meets JEDEC moisture sensitivity level 1 requirements.
Plating is matte tin over copper.

Typical Performance Curves: $V_{DD} = 3\text{ V}$

Gain

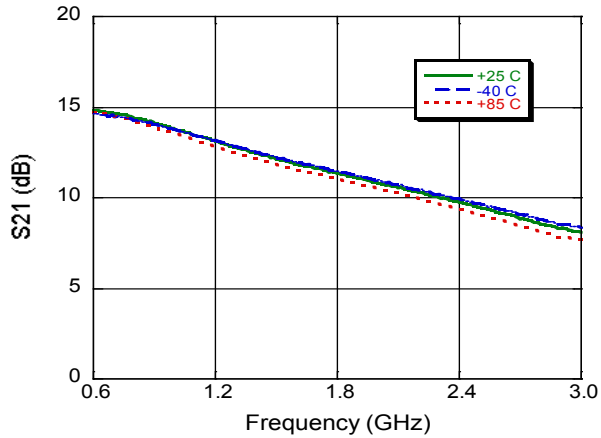

Input Return Loss

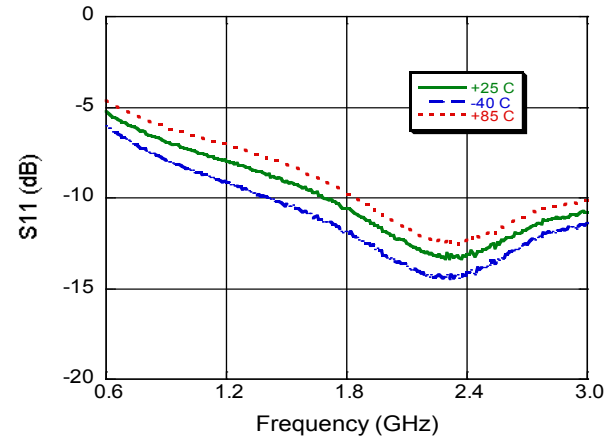

Output Return Loss

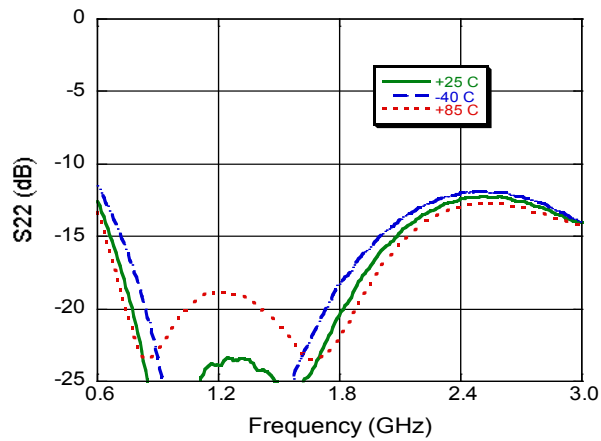

Noise Figure

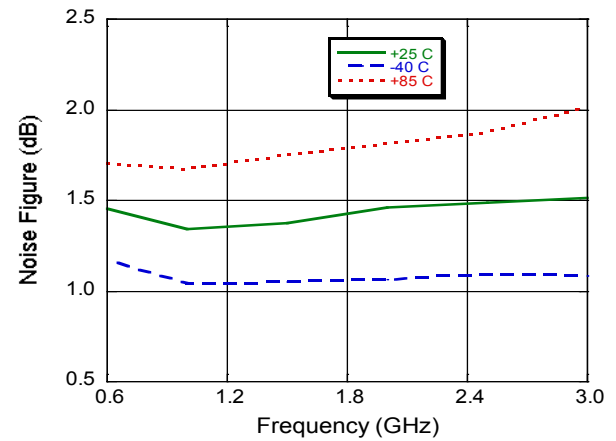

Output IP3, Input Power @ -12 dBm

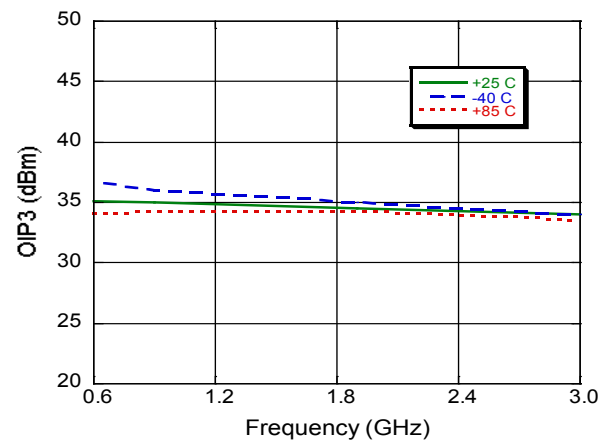

P1dB

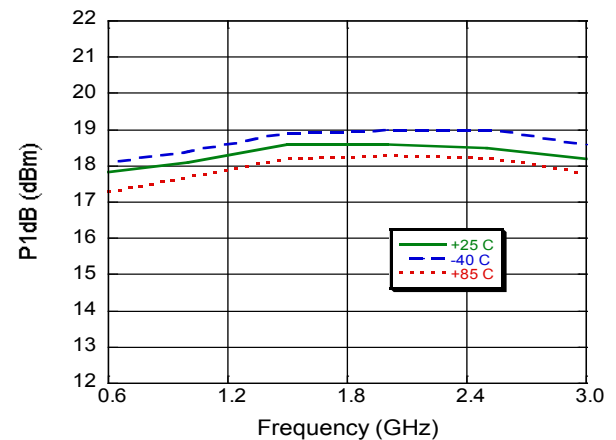

5 Volt Application Section for operation above 10 dBm output power

Application Layout Schematic @ 5 V⁸

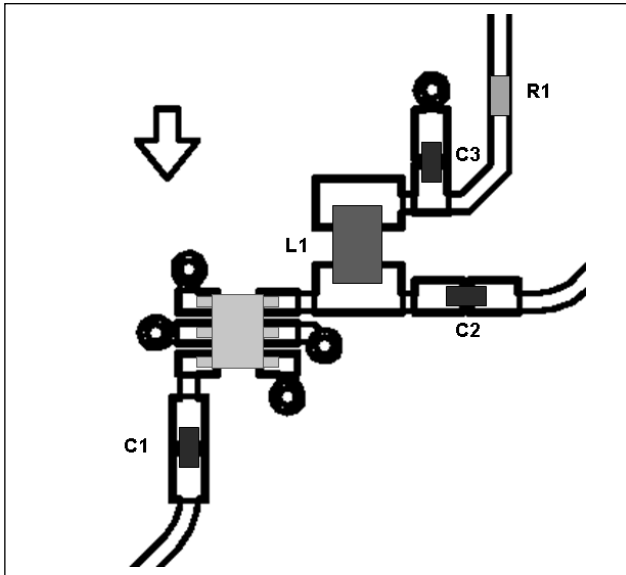

8. The addition of a 24.9 Ω series resistor on the drain line allows for 5 volt operation above 10 dBm output power, but no greater than 22 dBm of output power.

Application Schematic @ 5 V

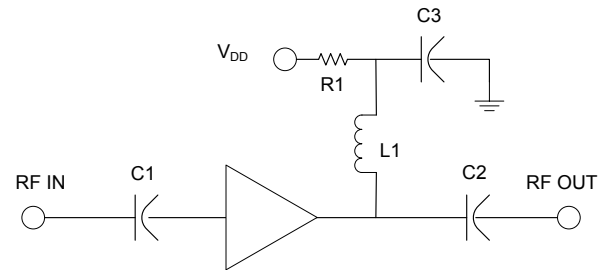

Component List @ 5 V

Part	Value	Case Style	Purpose
C1	39 pF	0402	Input DC Block
C2	39 pF	0402	Output DC Block
C3	470 pF	0402	RF Bypass
L1	12 nH	0805	RF Choke/Tuning
R1	24.9 Ω	0402	Voltage Drop

5 Volt Application Section for operation above 10 dBm output power

Typical Performance Curves: $V_{DD} = 5\text{ V}$

Gain

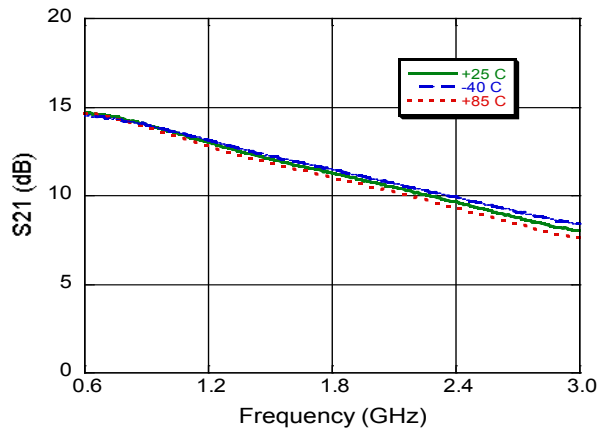

Input Return Loss

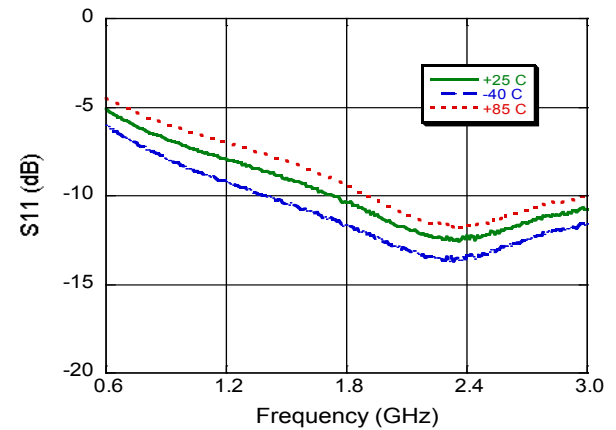

Output Return Loss

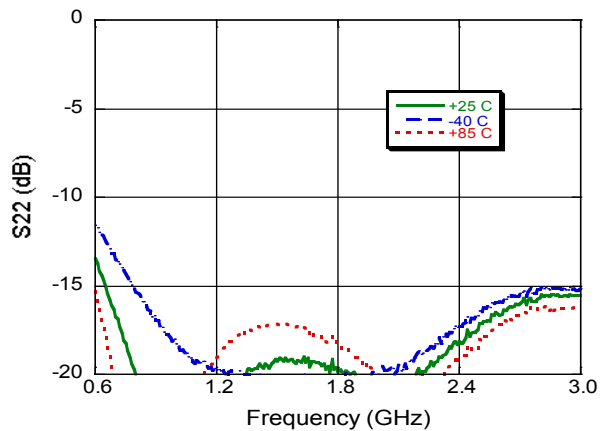

P1dB

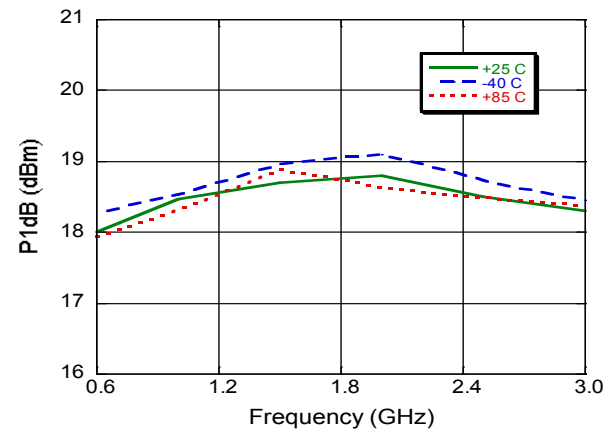

Output IP3

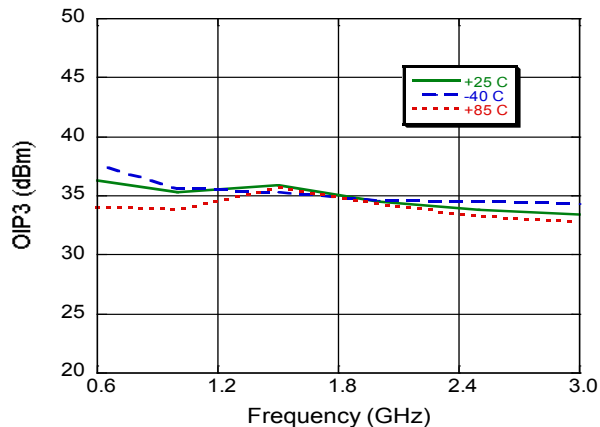

3 Volt Application Section 75 Ω Input - 50 Ω Output, 950 - 2150 MHz

950 - 2150 MHz, Recommended PCB Configuration

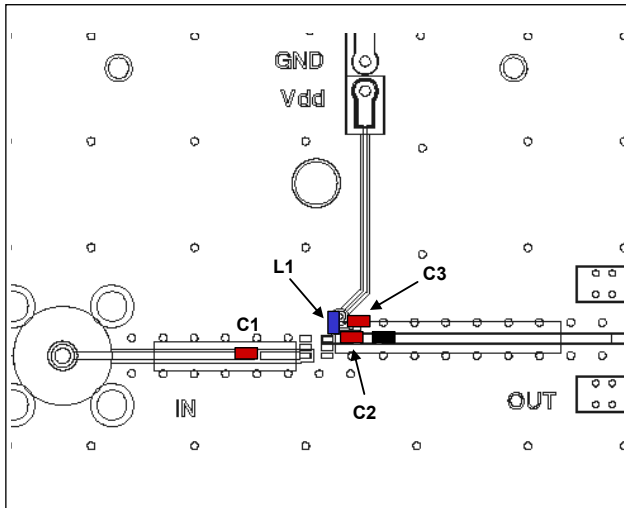

950 - 2150 MHz, Application Schematic

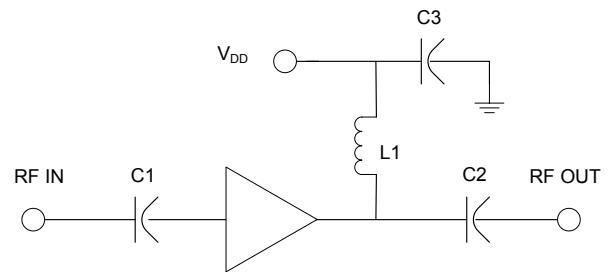

950 - 2150 MHz, Component List

Part	Value	Case Style	Purpose
C1	39 pF	0402	Input DC Block
C2	6 pF	0402	Output DC Block
C3	1000 pF	0402	RF Bypass
L1	19 nH	0402	RF Choke/Tuning

3 Volt Application Section
75 Ω Input - 50 Ω Output, 950 - 2150 MHz

Typical Performance Curves:

S-Parameters

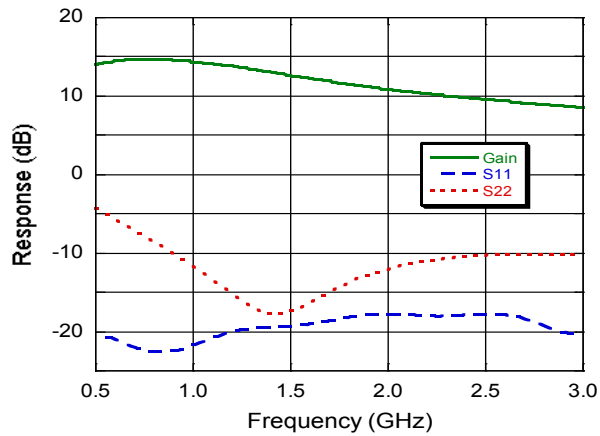

Noise

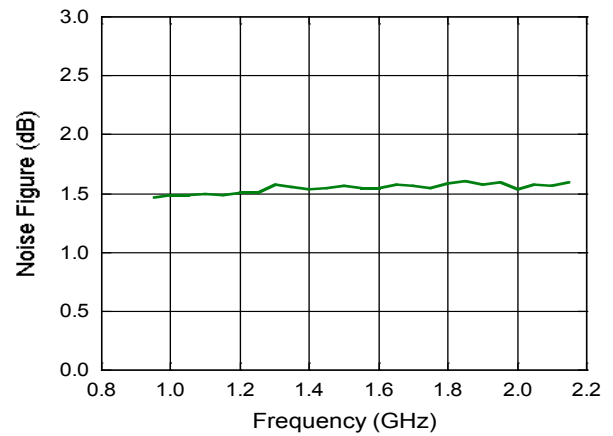

Output IP3

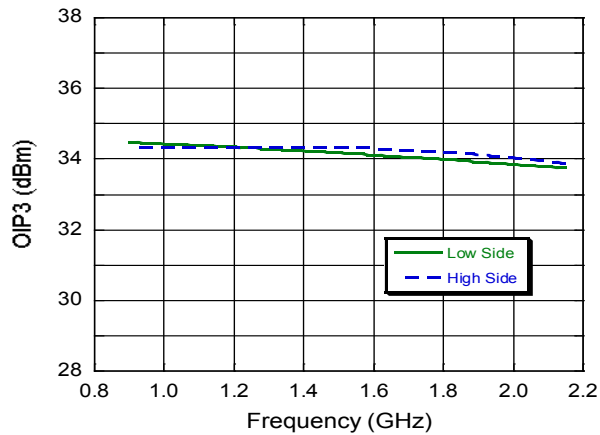

P1dB

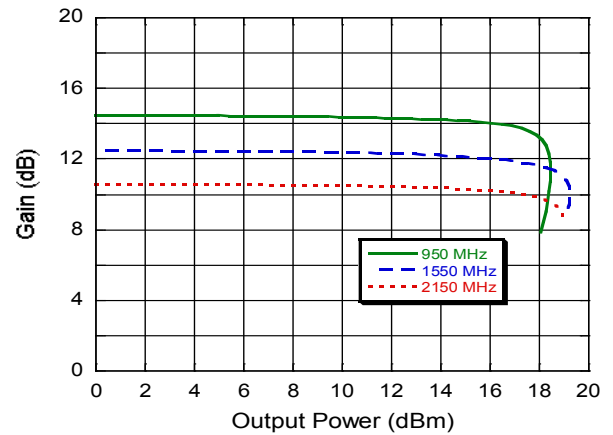

Application Section
50 Ω Input, 250 - 2350 MHz

250 - 2350 MHz,
Recommended PCB Configuration

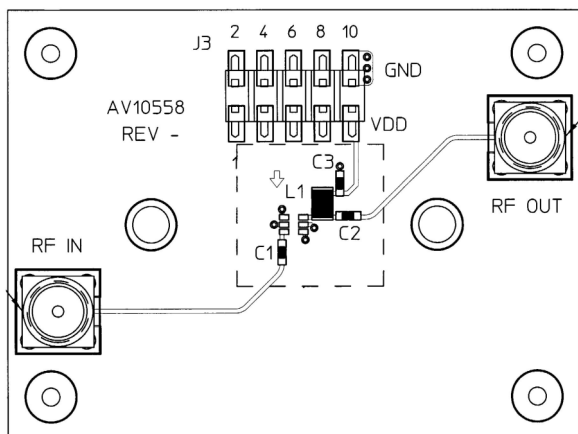

250 - 2350 MHz,
Application Schematic

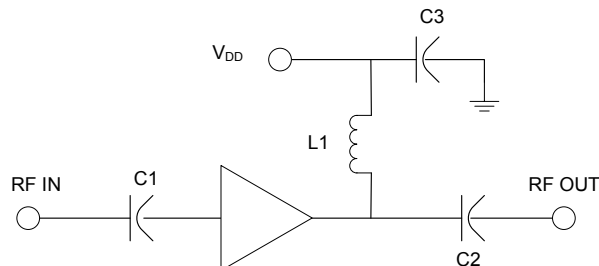

250 - 2350 MHz, Component List

Part	Value	Case Style	Purpose
C1	39 pF	0402	Input DC Block
C2	39 pF	0402	Output DC Block
C3	10 nF	0402	RF Bypass
L1	47 nH	0805	RF Choke/Tuning

Electrical Specifications: $T_A = +25^\circ\text{C}$, $V_{DD} = +2.5\text{ V}$, $Z_0 = 50\ \Omega$

Parameter	Test Conditions	Units	Min.	Typ.	Max.
Gain	0.25 GHz	dB	—	16.0	—
	1.9 GHz			11.0	
	2.35 GHz			9	
Noise Figure	0.25 GHz	dB	—	1.5	—
	1.9 GHz			1.5	
	2.35 GHz			1.5	
Input Return Loss	0.25 GHz	dB	—	9	—
	1.9 GHz			12	
	2.35 GHz			15	
Output Return Loss	0.25 GHz	dB	—	17	—
	1.9 GHz			20	
	2.35 GHz			20	
Current	—	mA	—	80	—

Application Section 50 Ω Input, 250 - 2350 MHz

Typical Performance Curves:

Gain

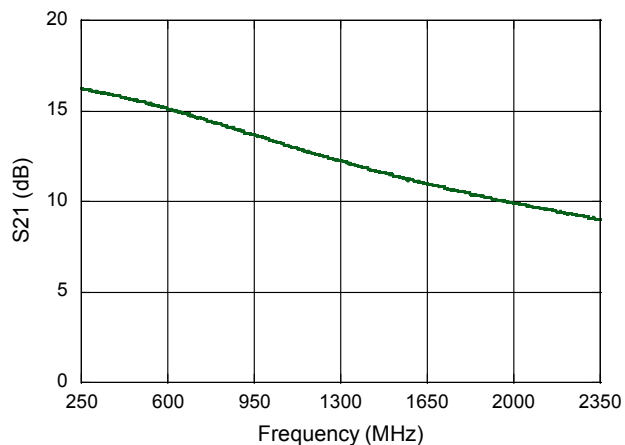

Input Return Loss

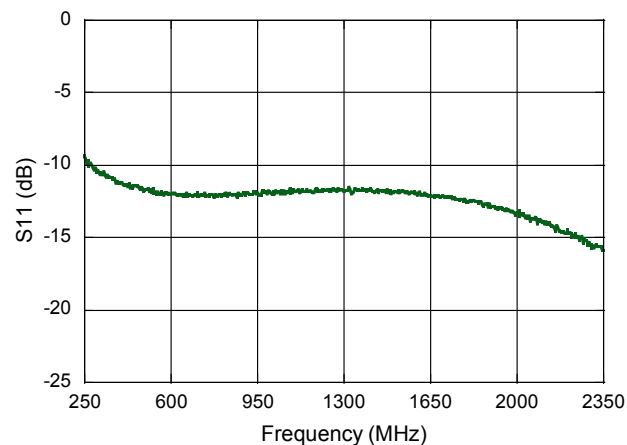

Output Return Loss

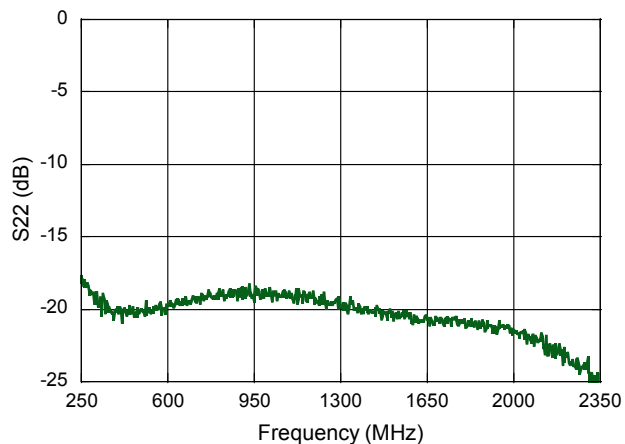

Noise Figure

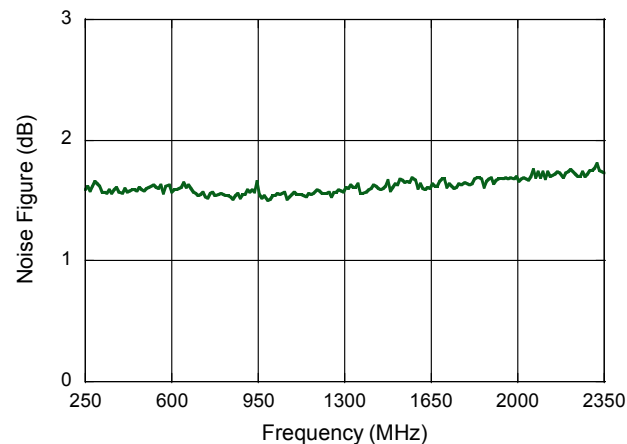

MACOM Technology Solutions Inc. All rights reserved.

Information in this document is provided in connection with MACOM Technology Solutions Inc ("MACOM") products. These materials are provided by MACOM as a service to its customers and may be used for informational purposes only. Except as provided in MACOM's Terms and Conditions of Sale for such products or in any separate agreement related to this document, MACOM assumes no liability whatsoever. MACOM assumes no responsibility for errors or omissions in these materials. MACOM may make changes to specifications and product descriptions at any time, without notice. MACOM makes no commitment to update the information and shall have no responsibility whatsoever for conflicts or incompatibilities arising from future changes to its specifications and product descriptions. No license, express or implied, by estoppel or otherwise, to any intellectual property rights is granted by this document.

THESE MATERIALS ARE PROVIDED "AS IS" WITHOUT WARRANTY OF ANY KIND, EITHER EXPRESS OR IMPLIED, RELATING TO SALE AND/OR USE OF MACOM PRODUCTS INCLUDING LIABILITY OR WARRANTIES RELATING TO FITNESS FOR A PARTICULAR PURPOSE, CONSEQUENTIAL OR INCIDENTAL DAMAGES, MERCHANTABILITY, OR INFRINGEMENT OF ANY PATENT, COPYRIGHT OR OTHER INTELLECTUAL PROPERTY RIGHT. MACOM FURTHER DOES NOT WARRANT THE ACCURACY OR COMPLETENESS OF THE INFORMATION, TEXT, GRAPHICS OR OTHER ITEMS CONTAINED WITHIN THESE MATERIALS. MACOM SHALL NOT BE LIABLE FOR ANY SPECIAL, INDIRECT, INCIDENTAL, OR CONSEQUENTIAL DAMAGES, INCLUDING WITHOUT LIMITATION, LOST REVENUES OR LOST PROFITS, WHICH MAY RESULT FROM THE USE OF THESE MATERIALS.

MACOM products are not intended for use in medical, lifesaving or life sustaining applications. MACOM customers using or selling MACOM products for use in such applications do so at their own risk and agree to fully indemnify MACOM for any damages resulting from such improper use or sale.