

# SAC-4P-M12MS/0,5-680/M12FS FDP - Sensor/actuator cable



1095904

<https://www.phoenixcontact.com/us/products/1095904>

Please be informed that the data shown in this PDF document is generated from our Online Catalog. Please find the complete data in the user documentation. Our General Terms of Use for Downloads are valid.



Sensor/actuator cable, 4-position, PVC, gray, shielded, Plug straight M12, coding: A, on Socket straight M12, coding: A, cable length: 0.5 m, Foil shielding plus drain wire

## Commercial Data

Item number	1095904
Packing unit	1 pc
Note	Made to Order (non-returnable)
Sales Key	BF13
Product Key	BF1IEB
GTIN	4055626928555
Weight per Piece (including packing)	22.22 g
Weight per Piece (excluding packing)	22.22 g
Country of origin	US

# SAC-4P-M12MS/0,5-680/M12FS FDP - Sensor/actuator cable



1095904

<https://www.phoenixcontact.com/us/products/1095904>

## Technical Data

### Product properties

Product type	Sensor/actuator cable
Number of positions	4
Application	Standard, U.S. cables
No. of cable outlets	1
Shielded	yes
Coding	A

### Insulation characteristics

Overvoltage category	II
Degree of pollution	3

### Material specifications

Flammability rating according to UL 94	HB
Seal material	NBR
Material of grip body	TPU, hardly inflammable, self-extinguishing
Contact material	CuSn
Contact surface material	Ni/Au
Contact carrier material	TPU GF
Material for screw connection	Zinc die-cast, nickel-plated

### Electrical properties

Contact resistance	$\leq 5 \text{ m}\Omega$
Insulation resistance	$\geq 10 \text{ M}\Omega$
Nominal voltage $U_N$	250 V AC
	250 V DC
Nominal current $I_N$	4 A
Protective circuit	unwired

### Mechanical properties

#### Mechanical data

Insertion/withdrawal cycles	$\geq 100$
-----------------------------	------------

### Signaling

Status display	No
Status display present	No

### Connection data

#### Conductor connection

Tightening torque	0.4 Nm (M12 connector)
-------------------	------------------------

# SAC-4P-M12MS/0,5-680/M12FS FDP - Sensor/actuator cable



1095904

<https://www.phoenixcontact.com/us/products/1095904>

## Connector

### Connection 1

Type	Plug straight M12
Coding type	A

### Connection 2

Type	Socket straight M12
Coding type	A

## Cable/line

Cable length	0.5 m
--------------	-------

PVC, gray, 105°C [680]

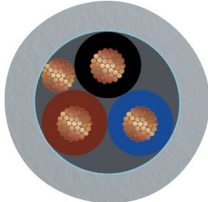
Dimensional drawing	
Cable weight	35.4 kg/km
UL AWM Style	2517 (105 °C / 300 V)
Number of positions	3
Shielded	yes
Cable type	PVC, gray, 105°C [680]
AWG signal line	22
Wire diameter incl. insulation	1.27 mm ±0.03 mm
External cable diameter	4.75 mm ±0.2 mm
Outer sheath, material	PVC
External sheath, color	gray
Conductor material	Tin-plated Cu litz wires
Material wire insulation	PVC (Signal line)
Single wire, color	brown, blue, black
Type of pair shielding	Plastic-coated aluminum foil, aluminum side inside
Overall twist	Conductors, fillers, and drain wire are twisted with left-hand lay
Max. conductor resistance	max. 51.1 Ω/km (20 °C)
Insulation resistance	≥ (550 M Ohms/m @ 500V)
Nominal voltage, cable	300 V
Minimum bending radius, flexible installation	8 x D
Flame resistance	FT4
Other resistance	UV resistant
Special properties	UL standards PLTC and ITC

# SAC-4P-M12MS/0,5-680/M12FS FDP - Sensor/actuator cable



1095904

<https://www.phoenixcontact.com/us/products/1095904>

Ambient temperature (operation)	-30 °C ... 105 °C (cable, fixed installation)
---------------------------------	---

## Environmental and real-life conditions

### Ambient conditions

Degree of protection	IP65
	IP67
	IP68
Ambient temperature (operation)	-25 °C ... 90 °C (Plug / socket)
	-40 °C ... 80 °C (cable, fixed installation)
	-5 °C ... 80 °C (Cable, flexible installation)

## Standards and regulations

Standards/specifications	IEC 61076-2-101
--------------------------	-----------------

# SAC-4P-M12MS/0,5-680/M12FS FDP - Sensor/actuator cable

1095904

<https://www.phoenixcontact.com/us/products/1095904>

## Drawings

Schematic diagram

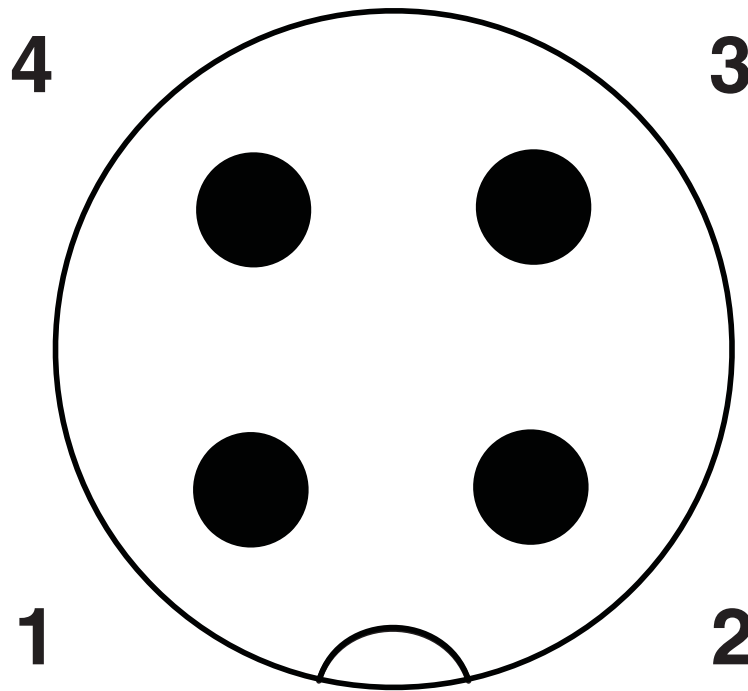

Pin assignment M12 plug, 4-pos., A-coded, view plug side

Dimensional drawing

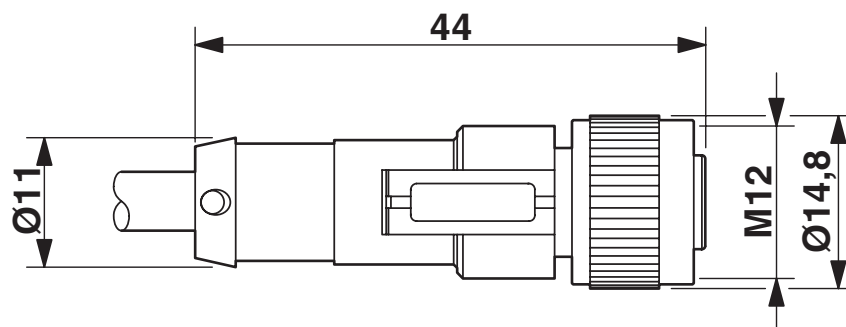

M12 x 1 socket, straight

# SAC-4P-M12MS/0,5-680/M12FS FDP - Sensor/actuator cable



1095904

<https://www.phoenixcontact.com/us/products/1095904>

Circuit diagram

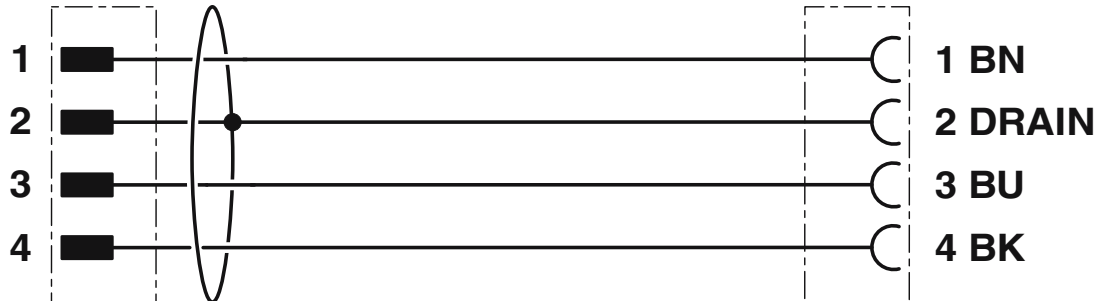

Dimensional drawing

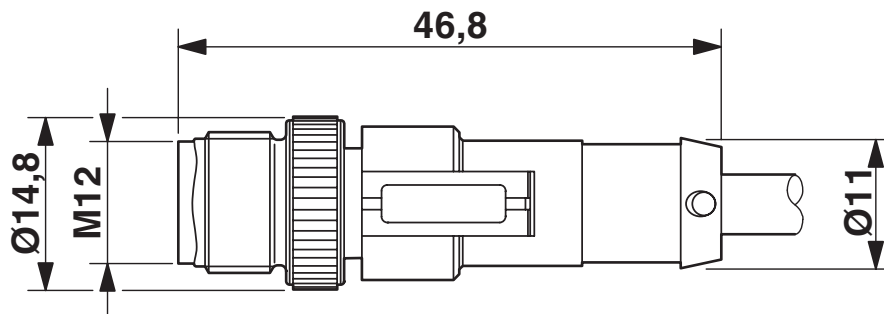

Plug, M12 x 1, straight

# SAC-4P-M12MS/0,5-680/M12FS FDP - Sensor/actuator cable

1095904

<https://www.phoenixcontact.com/us/products/1095904>

Schematic diagram

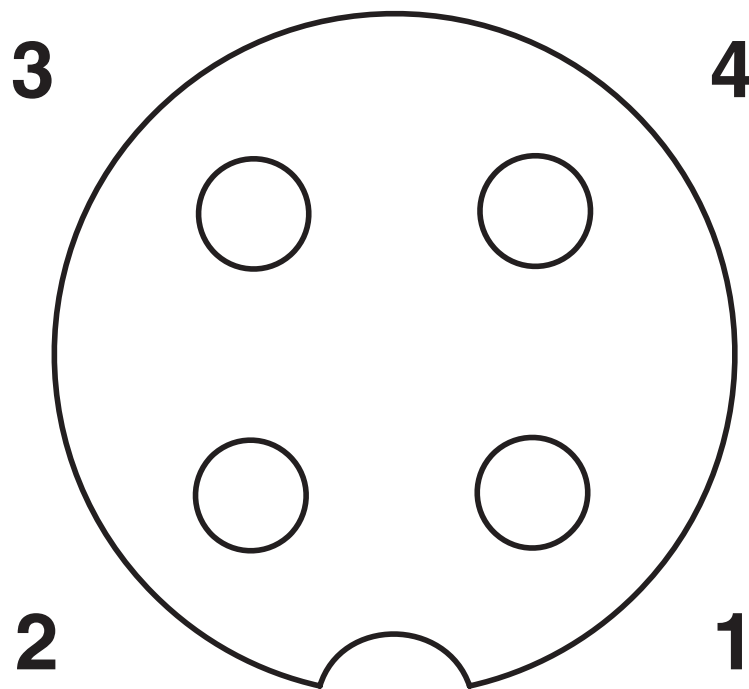

Pin assignment M12 socket, 4-pos., A-coded, view female side

# SAC-4P-M12MS/0,5-680/M12FS FDP - Sensor/actuator cable



1095904

<https://www.phoenixcontact.com/us/products/1095904>

## Approvals

 <b>UL Listed</b> Approval ID: FILE E 221474				
	Nominal Voltage $U_N$	Nominal Current $I_N$	Cross Section AWG	Cross Section $\text{mm}^2$
	300 V	4 A	-	-

 <b>cUL Listed</b> Approval ID: FILE E 221474				
	Nominal Voltage $U_N$	Nominal Current $I_N$	Cross Section AWG	Cross Section $\text{mm}^2$
	300 V	4 A	-	-



# SAC-4P-M12MS/0,5-680/M12FS FDP - Sensor/actuator cable



1095904

<https://www.phoenixcontact.com/us/products/1095904>

## Classifications

### ECLASS

ECLASS-11.0	27060311
ECLASS-12.0	27060311
ECLASS-13.0	27060311

### UNSPSC

UNSPSC 21.0	31251501
-------------	----------

# SAC-4P-M12MS/0,5-680/M12FS FDP - Sensor/actuator cable



1095904

<https://www.phoenixcontact.com/us/products/1095904>

## Accessories

### PROT-M12 FS-PA-CHAIN - Sealing cap

1430873

<https://www.phoenixcontact.com/us/products/1430873>

M12 sealing cap made of plastic with fixing band, for sensor cables, for free M12 plugs



---

### SAC-M12-EXCLIP-M - Locking clip

1558988

<https://www.phoenixcontact.com/us/products/1558988>

Locking clip for the pin side of sensor/actuator cables with M12 connector and M12 connectors for assembly, for knurl diameter: 15 mm or for Allen key with a wrench size of 14 mm, prevents the disconnection of plug-in connections without tools



# SAC-4P-M12MS/0,5-680/M12FS FDP - Sensor/actuator cable



1095904

<https://www.phoenixcontact.com/us/products/1095904>

## PROT-M12 MS-PA-CHAIN - Screw plug

1430899

<https://www.phoenixcontact.com/us/products/1430899>

M12 sealing cap with fixing band, for sensor cables, for free M12 sockets



---

## SAC-M12-EXCLIP-F - Locking clip

1558991

<https://www.phoenixcontact.com/us/products/1558991>

Locking clip for the socket side of sensor/actuator cables with M12 connector and M12 connectors for assembly, for knurl diameter: 15 mm or for Allen key with a wrench size of 14 mm, prevents the disconnection of plug-in connections without tools



# SAC-4P-M12MS/0,5-680/M12FS FDP - Sensor/actuator cable



1095904

<https://www.phoenixcontact.com/us/products/1095904>

## TSD 04 SAC - Torque screwdriver

1208429

<https://www.phoenixcontact.com/us/products/1208429>



Torque screwdriver, with preset torque of 0.4 Nm and 4 mm hexagonal drive for M12 connectors

---

## TSD-M 1,2NM - Torque screwdriver

1212224

<https://www.phoenixcontact.com/us/products/1212224>



Torque screw driver, accuracy as per EN ISO 6789 standard, adjustable from 0.3 - 1.2 Nm

# SAC-4P-M12MS/0,5-680/M12FS FDP - Sensor/actuator cable



1095904

<https://www.phoenixcontact.com/us/products/1095904>

## TSD-M SAC-BIT ADAPTER - Adapter insert

1212600

<https://www.phoenixcontact.com/us/products/1212600>



Adapter bit for TSD-M...torque tools, E6.3-1/4" drive with 4 mm hexagon to accommodate SAC bits

---

## SAC BIT M12-D15 - Tool

1208432

<https://www.phoenixcontact.com/us/products/1208432>



Nut for assembling sensor/actuator cables with M12 connector and M12 connectors for assembly, with a knurl diameter of 15 mm, for 4 mm hexagonal drive

---

Phoenix Contact 2023 © - all rights reserved  
<https://www.phoenixcontact.com>

Phoenix Contact USA  
586 Fulling Mill Road  
Middletown, PA 17057, United States  
(+717) 944-1300  
[info@phoenixcon.com](mailto:info@phoenixcon.com)