

Features

- LO: 2 to 26 GHz
- RF: 2 to 26 GHz
- IF: 1 to 15 GHz
- LO Drive +10 dBm (nominal)
- High Compression Point
- Very Wide Bandwidth

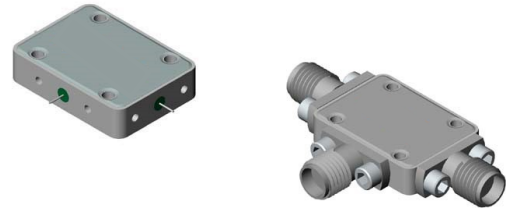

Applications

- Aerospace & Defense
- ISM

Description

MY50 is a triple balanced mixer, that utilizes Schottky ring quad diodes and broadband soft dielectric baluns to attain excellent performance. The use of high temperature solder assembly processes used internally makes it ideal for use in manual, semi-automated assembly. Environmental screening available to MIL-STD-883, MIL-STD-202 or MIL-DTL-28837, consult factory.

Electrical Specifications: $Z_0 = 50 \Omega$ $Lo = +10$ dBm (Downconverter Application only)

Parameter	Test Conditions	Units	Typical	Guaranteed	
				+25°C	-54° to +85°C
SSB Conversion Loss (max.)	fR = 2.5 to 18 GHz, fL = 2 to 18 GHz, fl = 2 to 10 GHz	dB	7.5	9.5	10.0
	fR = 2.0 to 18 GHz, fL = 2 to 26 GHz, fl = 2 to 12 GHz		8.0	10.5	
	fR = 2.0 to 26 GHz, fL = 2 to 26 GHz, fl = 1 to 15 GHz		9.0	11.5	
SSB Noise Figure (max.)	—	dB	±1 dB of conversion loss		
Isolation, L to R (min.)	fL = 2 to 3 GHz	dB	30	15	13
	fL = 3 to 26 GHz		22	20	18
Isolation, L to I (min.)	fL = 2 to 7 GHz	dB	30	15	13
	fL = 7 to 26 GHz		22	20	20
1 dB Conversion Comp.	fL = +10 dBm	dBm	5	—	—
Input IP3	fR1 = 5 GHz at -6 dBm, fR2 = 5.01 GHz at -6 dBm, fL = 8 GHz at +10 dBm	dBm	15	—	—
	fR1 = 25 GHz at -6 dBm, fR2 = 25.01 GHz at -6 dBm, fL = 15 GHz at +10 dBm		15	—	—

Ordering Information

Part Number	Package
MY50	Versapac
MY50C	SMA Connectorized

Absolute Maximum Ratings

Parameter	Absolute Maximum
Peak Input Power	26 dBm @ +25°C 22 dBm @ +100°C
Peak Input Current	100 mA DC
Operating Temperature	-54°C to +100°C
Storage Temperature	-65°C to +100°C

Typical Performance Curves

Conversion Loss vs. Low Drive Level
 FL = 16 GHz, FR = 20 GHz @ -10 dBm

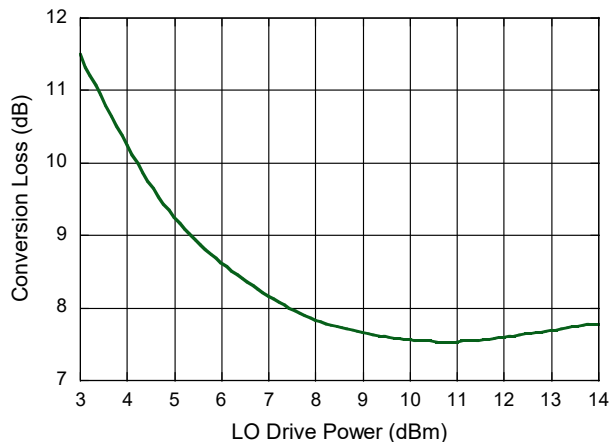

Conversion Loss vs. Frequency
 IF = 1 GHz

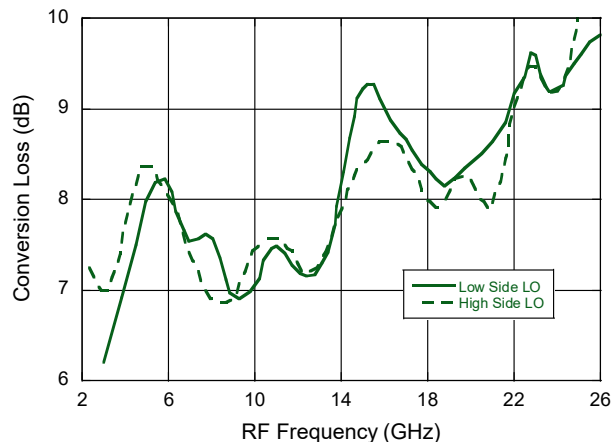

Conversion Loss vs. Frequency
 IF = 8 GHz

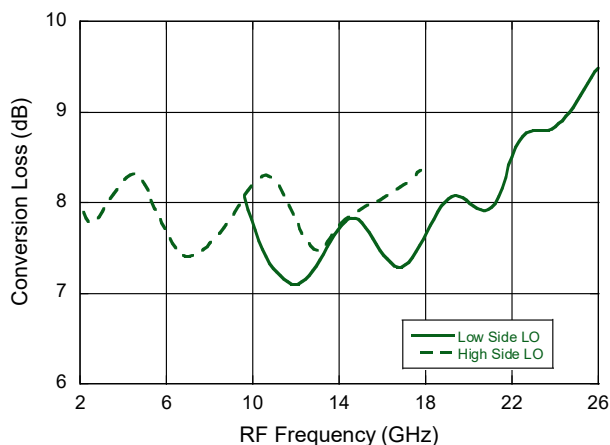

Conversion Loss vs. Frequency
 IF = 15 GHz

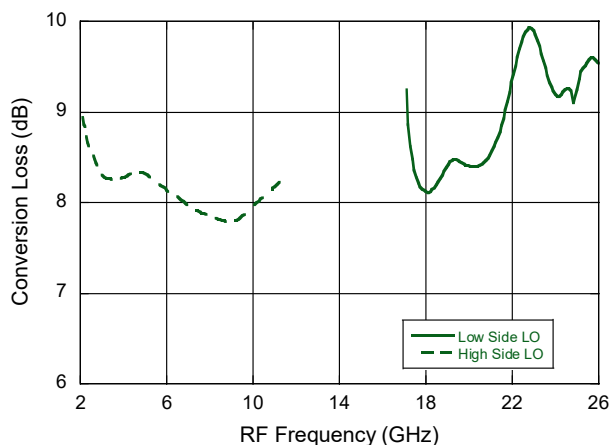

Typical Performance Curves

Isolation vs. LO Frequency

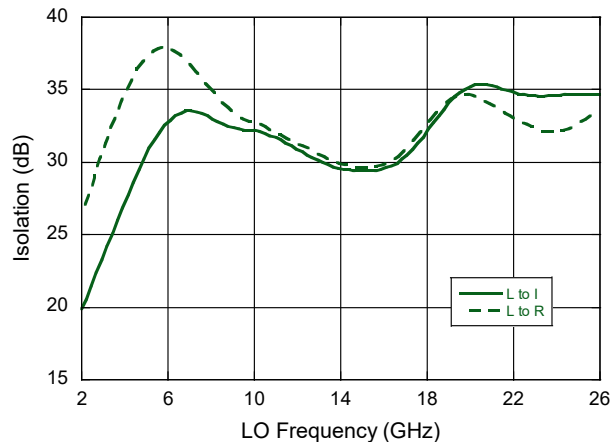

Isolation vs. RF Frequency

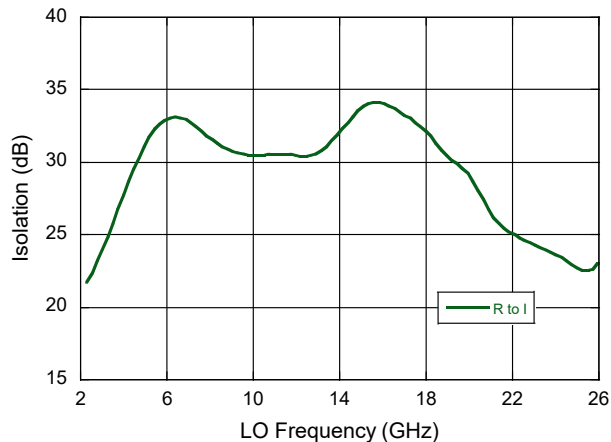

VSWR (R-Port)
RF = 18.26 GHz @ -8 dBm
LO = 16.00 GHz @ +10 dBm

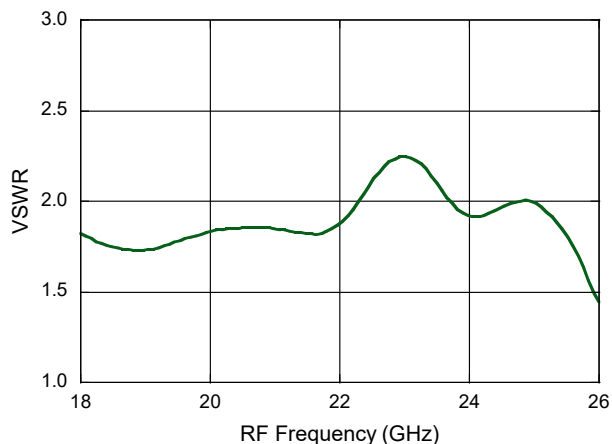

VSWR (L-Port)

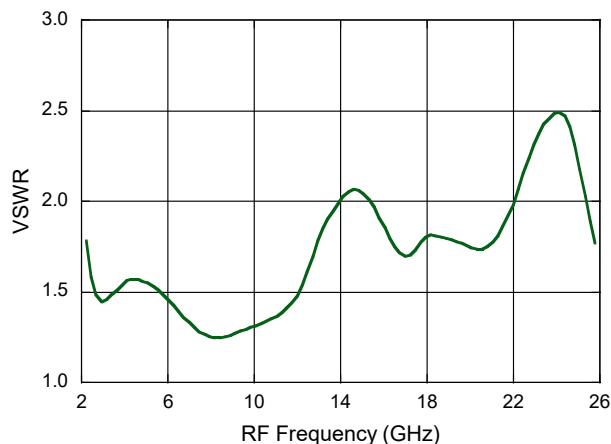

VSWR (R-Port)
LO = 26 GHz

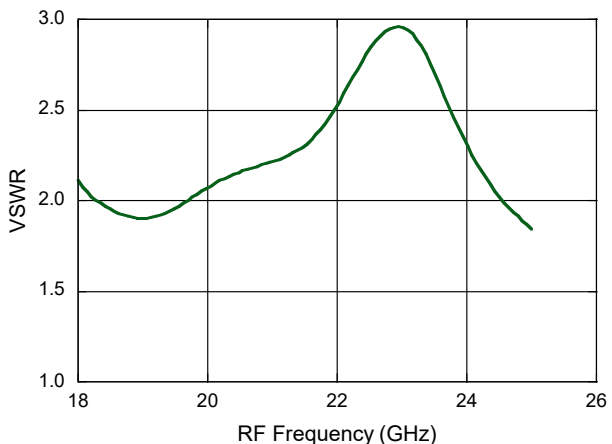

Typical Performance Curves

VSWR (I-Port)
LO = 2 GHz

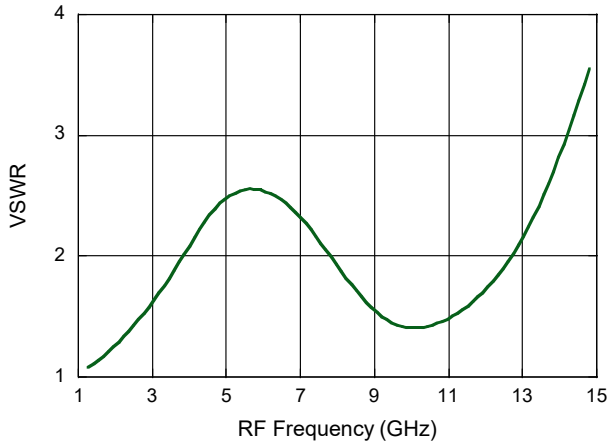

VSWR (I-Port)
LO = 6 GHz

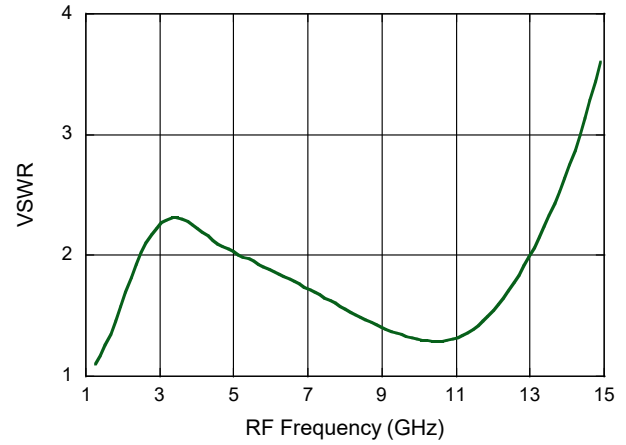

VSWR (I-Port)
LO = 18 GHz

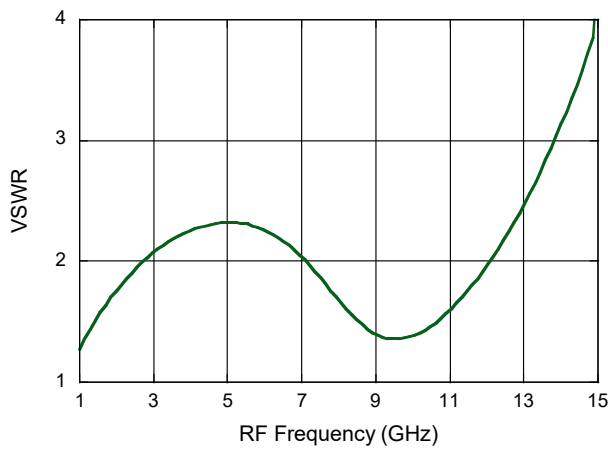

VSWR (I-Port)
LO = 26 GHz

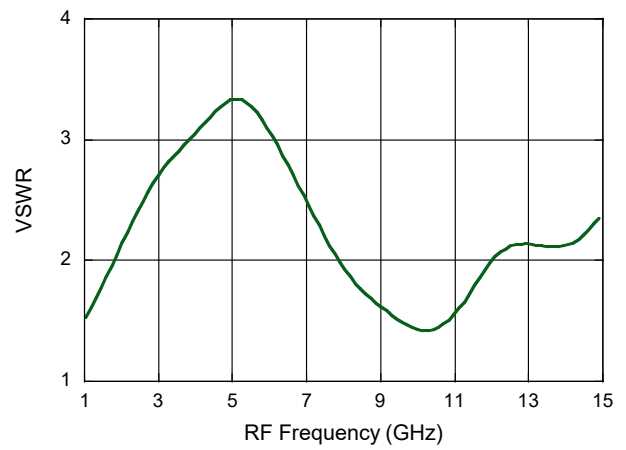

Outline Drawing: Versapac*

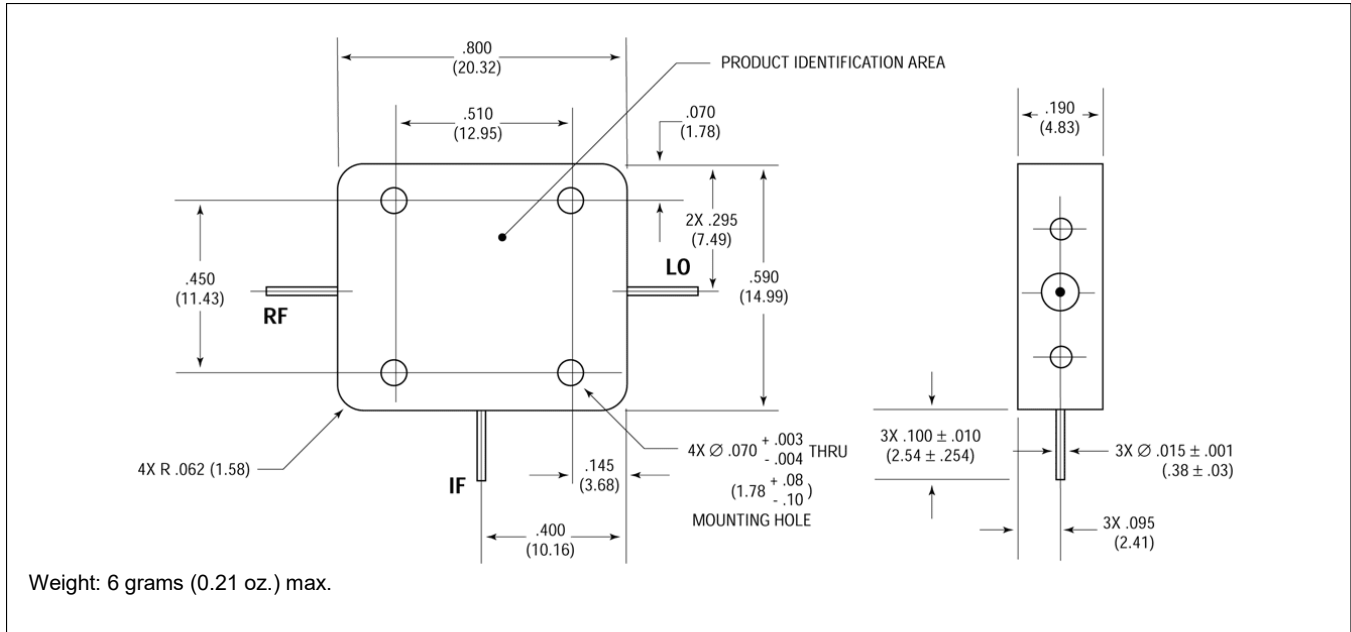

Outline Drawing: SMA Connectorized*

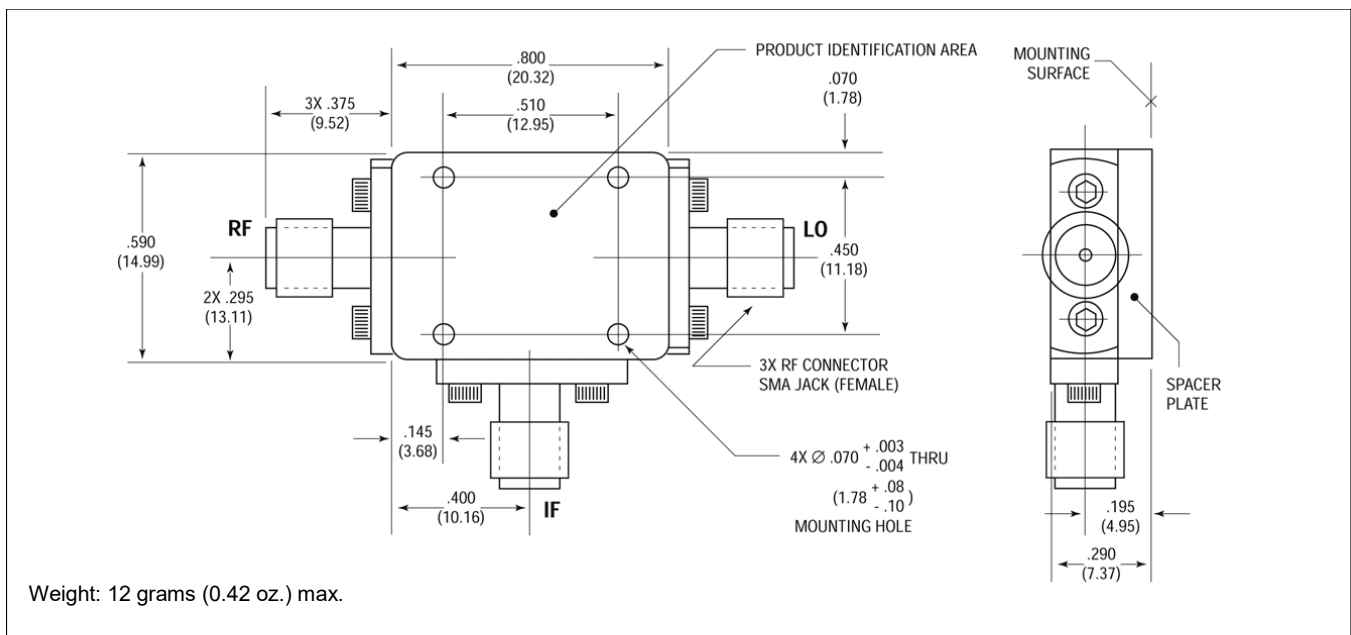

* Dimensions are inches (millimeters) ± 0.015 (0.38) unless otherwise specified.

MACOM Technology Solutions Inc. ("MACOM"). All rights reserved.

These materials are provided in connection with MACOM's products as a service to its customers and may be used for informational purposes only. Except as provided in its Terms and Conditions of Sale or any separate agreement, MACOM assumes no liability or responsibility whatsoever, including for (i) errors or omissions in these materials; (ii) failure to update these materials; or (iii) conflicts or incompatibilities arising from future changes to specifications and product descriptions, which MACOM may make at any time, without notice. These materials grant no license, express or implied, to any intellectual property rights.

THESE MATERIALS ARE PROVIDED "AS IS" WITH NO WARRANTY OR LIABILITY, EXPRESS OR IMPLIED, RELATING TO SALE AND/OR USE OF MACOM PRODUCTS INCLUDING FITNESS FOR A PARTICULAR PURPOSE, MERCHANTABILITY, INFRINGEMENT OF INTELLECTUAL PROPERTY RIGHT, ACCURACY OR COMPLETENESS, OR SPECIAL, INDIRECT, INCIDENTAL, OR CONSEQUENTIAL DAMAGES WHICH MAY RESULT FROM USE OF THESE MATERIALS.

MACOM products are not intended for use in medical, lifesaving or life sustaining applications. MACOM customers using or selling MACOM products for use in such applications do so at their own risk and agree to fully indemnify MACOM for any damages resulting from such improper use or sale.