

CDBDSC51200-G

Reverse Voltage: 1200 V

Forward Current: 5 A

RoHS Device

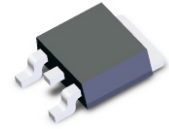

Features

- Rated to 1200V at 5A.
- Zero reverse recovery current.
- Zero forward recovery voltage.
- Temperature independent switching behaviour.
- High temperature operation.
- High frequency operation.

Mechanical data

- Case: TO-252/D-PAK, molded plastic.
- Terminals: Solderable per MIL-STD-750, method 2026.

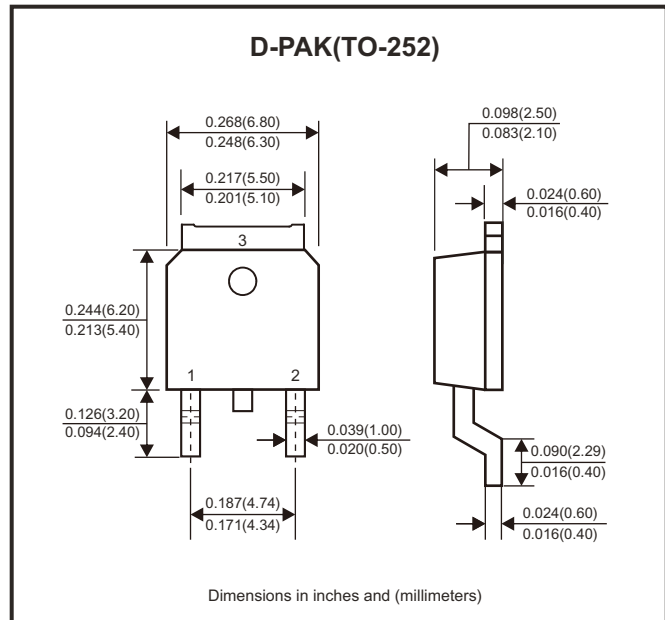

Circuit Diagram

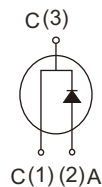

Maximum Ratings (at $T_A=25^\circ\text{C}$, unless otherwise noted)

Parameter	Conditions	Symbol	Limits	Unit
Repetitive peak reverse voltage	$T_j = 25^\circ\text{C}$	V_{RRM}	1200	V
Surge peak reverse voltage	$T_j = 25^\circ\text{C}$	V_{RSM}	1200	V
DC blocking voltage	$T_j = 25^\circ\text{C}$	V_{DC}	1200	V
Continuous forward current	$T_j = 25^\circ\text{C}$	I_F	18	A
	$T_j = 135^\circ\text{C}$		8.5	
	$T_j = 158^\circ\text{C}$		5	
Repetitive peak forward surge current	$T_C = 25^\circ\text{C}$, $t_p = 10\text{ms}$ Half sine wave, $D = 0.3$	I_{FRM}	25	A
Non-repetitive peak forward surge current	$T_C = 25^\circ\text{C}$, $t_p = 10\text{ms}$ Half sine wave	I_{FSM}	50	A
Power dissipation	$T_C = 25^\circ\text{C}$	P_{TOT}	109.5	W
	$T_C = 110^\circ\text{C}$		47	
Typical thermal resistance	Junction to case	$R_{\theta JC}$	1.37	$^\circ\text{C/W}$
Operating junction temperature range		T_j	-55 ~ +175	$^\circ\text{C}$
Storage temperature range		T_{STG}	-55 ~ +175	$^\circ\text{C}$

Electrical Characteristics (at $T_A=25^\circ\text{C}$, unless otherwise noted)

Parameter	Conditions	Symbol	Min.	Typ.	Max.	Unit
Forward voltage	$I_F = 5\text{A}, T_j = 25^\circ\text{C}$	V_F		1.45	1.7	V
	$I_F = 5\text{A}, T_j = 175^\circ\text{C}$			2.05	2.5	
Reverse current	$V_R = 1200\text{V}, T_j = 25^\circ\text{C}$	I_R		20	100	μA
	$V_R = 1200\text{V}, T_j = 175^\circ\text{C}$			50	200	
Total capacitive charge	$V_R = 800\text{V}, T_j = 150^\circ\text{C}$ $Q_C = \int_0^{V_R} C(V) dV$	Q_C		36		nC
Total capacitance	$V_R = 0\text{V}, T_j = 25^\circ\text{C}, f = 1\text{MHz}$	C		475	510	pF
	$V_R = 400\text{V}, T_j = 25^\circ\text{C}, f = 1\text{MHz}$			34	44	
	$V_R = 800\text{V}, T_j = 25^\circ\text{C}, f = 1\text{MHz}$			33	40	

Rating and Characteristic Curves (CDBDSC51200-G)

Fig.1 - Forward Characteristics

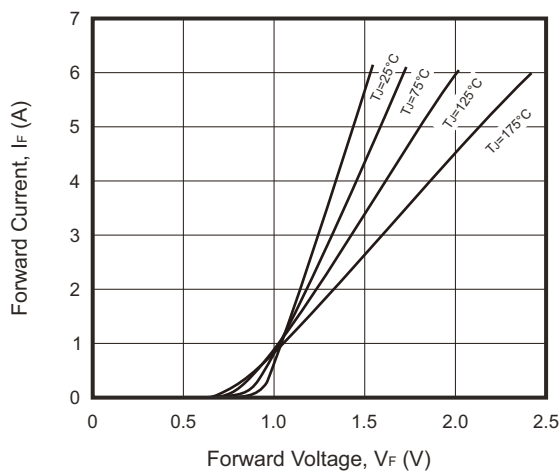

Fig.2 - Reverse Characteristics

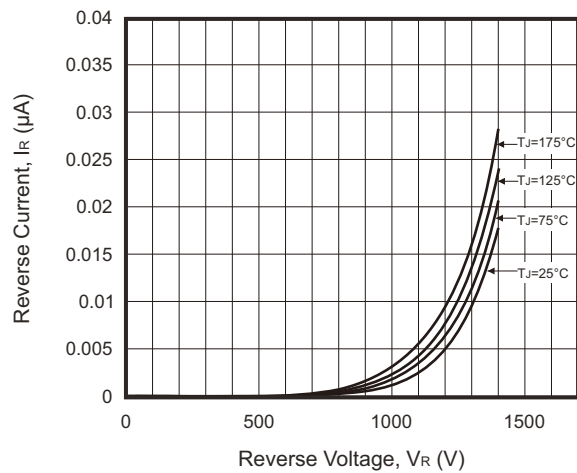

Fig.3 - Current Derating

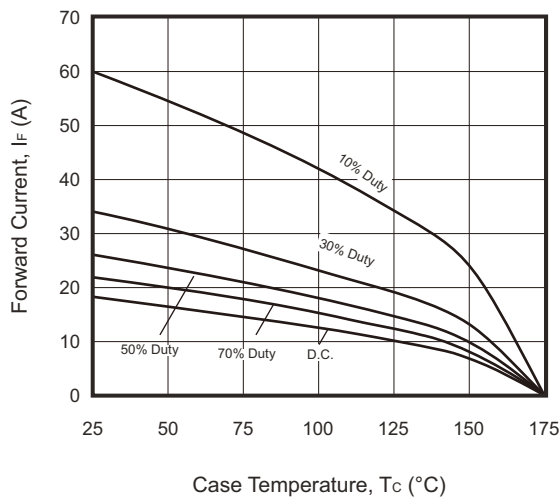
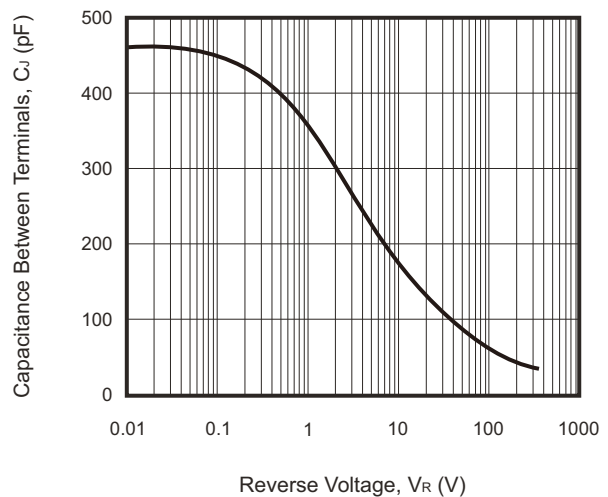
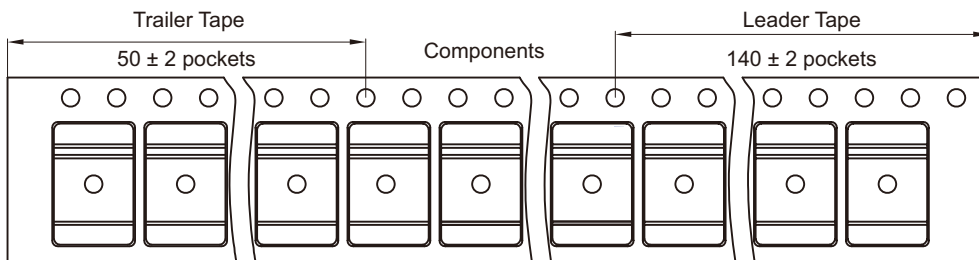
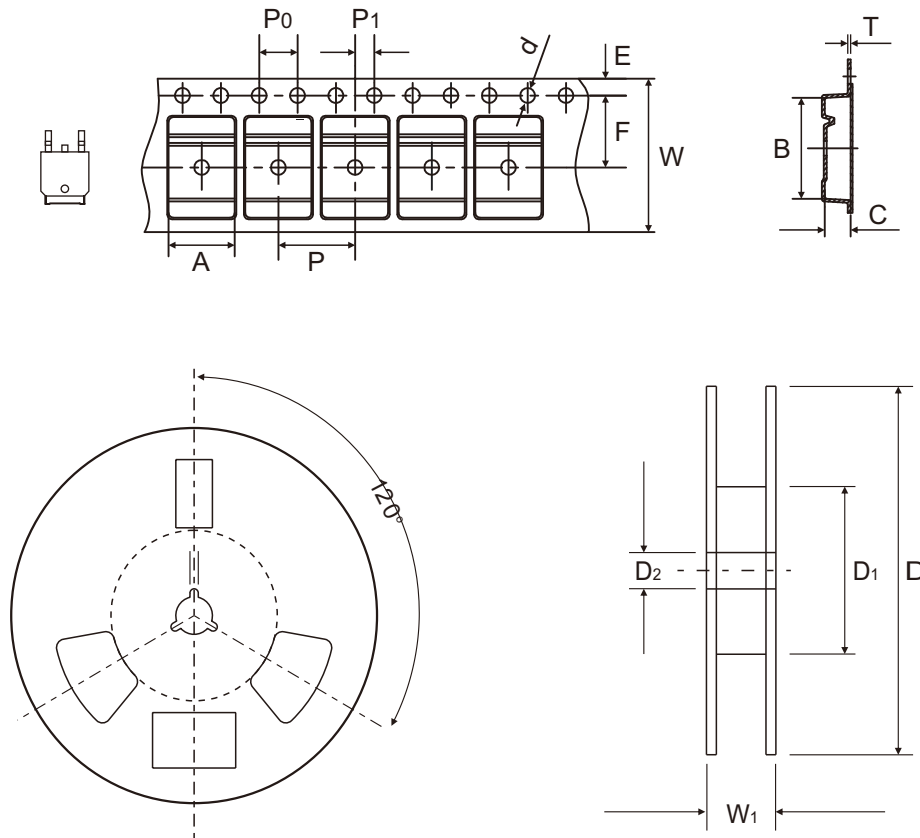

Fig.4 - Capacitance Characteristics



Reel Taping Specification



TO-252 (D-PAK)	SYMBOL	A	B	C	d	D	D1	D2
	(mm)	6.90 ± 0.10	10.50 ± 0.10	2.70 ± 0.10	1.55 ± 0.05	332 Max	100.00 ± 2.00	13.00 Min
	(inch)	0.272 ± 0.004	0.413 ± 0.004	0.106 ± 0.004	0.061 ± 0.002	13.071 Max	3.937 ± 0.079	0.512 Min

TO-252 (D-PAK)	SYMBOL	E	F	P	P0	P1	T	W	W1
	(mm)	1.75 ± 0.10	7.50 ± 0.10	8.00 ± 0.10	4.00 ± 0.10	2.00 ± 0.10	0.30 ± 0.05	16.00 ± 0.10	22.4 Max
	(inch)	0.069 ± 0.004	0.295 ± 0.004	0.315 ± 0.004	0.157 ± 0.004	0.079 ± 0.004	0.012 ± 0.002	0.630 ± 0.004	0.882 Max

Marking Code

Part Number	Marking Code
CDBDSC51200-G	DSC51200
	G3S12005C
	G5S12005C

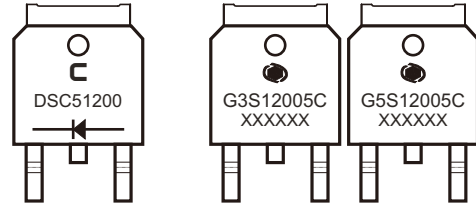

C = Comchip Logo xxxxxx = Control code

Suggested P.C.B. PAD Layout

SIZE	TO-252 / DPAK	
	(mm)	(inch)
A	4.57	0.180
B	1.20	0.047
C	5.80	0.228
D	5.85	0.230
E	2.00	0.079

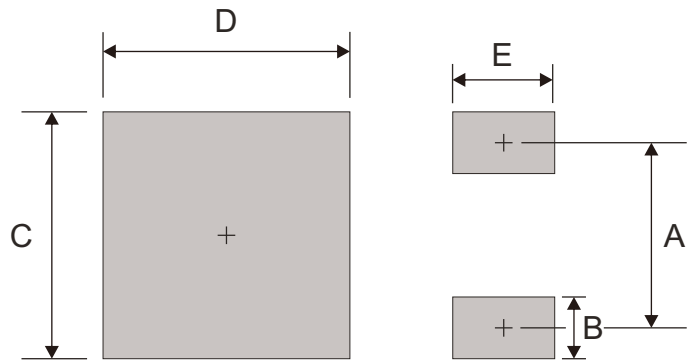

Note: 1. The pad layout is for reference purpose only.

Standard Packaging

Case Type	REEL PACK	
	REEL (pcs)	REEL SIZE (inch)
TO-252/D-PAK	2,500	13