

CDBDSC10650-G

Reverse Voltage: 650 V

Forward Current: 10 A

RoHS Device

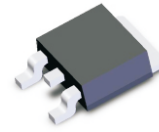

Features

- Rated to 650V at 10A.
- Short recovery time.
- High speed switching possible.
- High frequency operation.
- High temperature operation.
- Temperature independent switching behaviour.
- Positive temperature coefficient on V_f .

Mechanical data

- Case: TO-252/DPAK, molded plastic.
- Terminals: Solderable per MIL-STD-750, method 2026.

Circuit Diagram

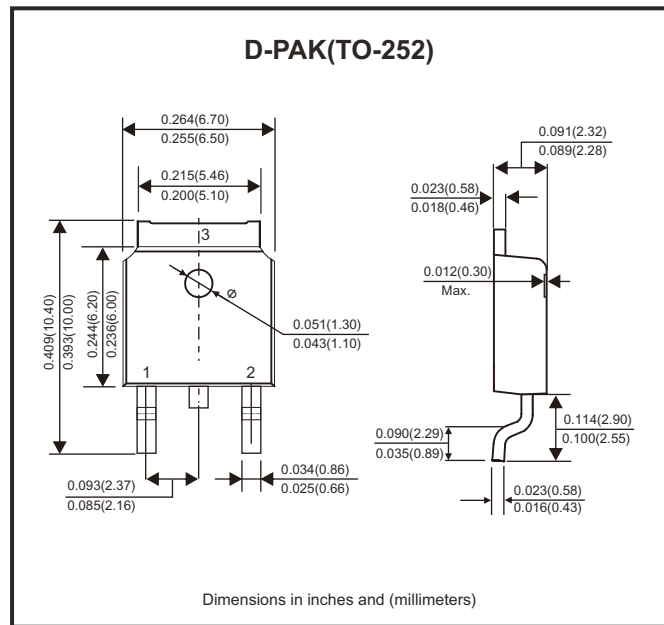
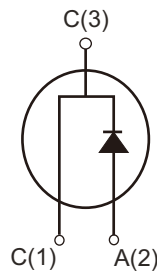

Maximum Ratings (at $T_A=25^{\circ}\text{C}$, unless otherwise noted)

Parameter	Conditions	Symbol	Value	Unit
Repetitive peak reverse voltage		V_{RRM}	650	V
Surge peak reverse voltage		V_{RSM}	650	V
DC blocking voltage		V_{DC}	650	V
Typical continuous forward current	$T_c = 150^{\circ}\text{C}$	I_F	10	A
Repetitive peak forward surge current	$T_c = 25^{\circ}\text{C}$, $t_p = 10\text{ms}$ Half sine wave, $D = 0.3$	I_{FRM}	50	A
Non-repetitive peak forward surge current	$T_c = 25^{\circ}\text{C}$, $t_p = 10\text{ms}$ Half sine wave	I_{FSM}	100	A
Power dissipation	$T_c = 25^{\circ}\text{C}$	P_{TOT}	109	W
	$T_c = 110^{\circ}\text{C}$		48	
Typical thermal resistance	Junction to case	$R_{\theta JC}$	1.37	$^{\circ}\text{C}/\text{W}$
Operating junction temperature range		T_J	-55 ~ +175	$^{\circ}\text{C}$
Storage temperature range		T_{STG}	-55 ~ +175	$^{\circ}\text{C}$

Electrical Characteristics (at $T_A=25^\circ\text{C}$, unless otherwise noted)

Parameter	Conditions	Symbol	Min.	Typ.	Max.	Unit
Forward voltage	$I_F = 10\text{A}, T_J = 25^\circ\text{C}$	V_F		1.48	1.7	V
	$I_F = 10\text{A}, T_J = 175^\circ\text{C}$			1.7		
Reverse current	$V_R = 650\text{V}, T_J = 25^\circ\text{C}$	I_R		20	100	μA
	$V_R = 650\text{V}, T_J = 175^\circ\text{C}$			30		
Total capacitive charge	$V_R = 400\text{V}, T_J = 150^\circ\text{C}$ $Q_C = \int_0^{V_R} C(V) dv$	Q_C		36		nC
Total capacitance	$V_R = 0\text{V}, T_J = 25^\circ\text{C}, f = 1\text{MHz}$	C		710		pF
	$V_R = 200\text{V}, T_J = 25^\circ\text{C}, f = 1\text{MHz}$			72		

Rating and Characteristic Curves (CDBDSC10650-G)

Fig.1 - Forward Characteristics

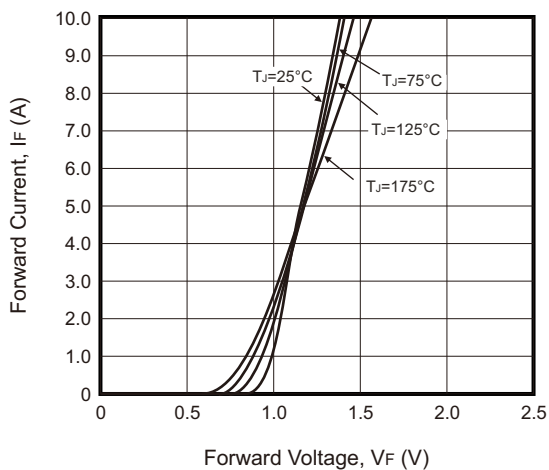

Fig.2 - Reverse Characteristics

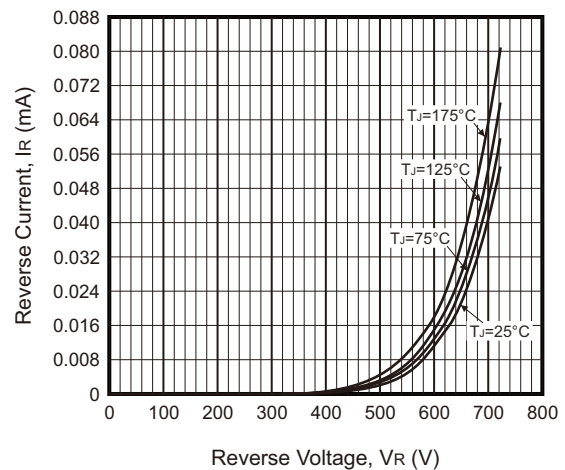

Fig.3 - Current Derating

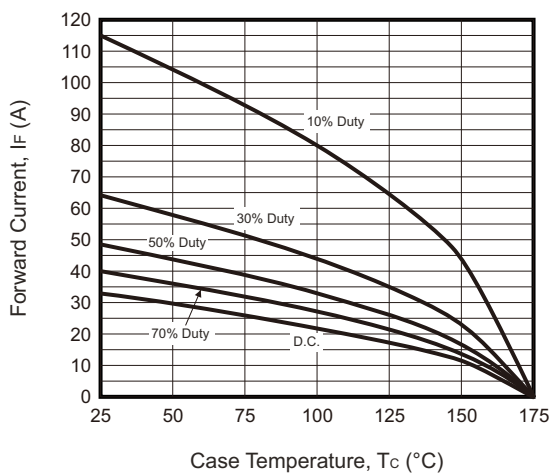
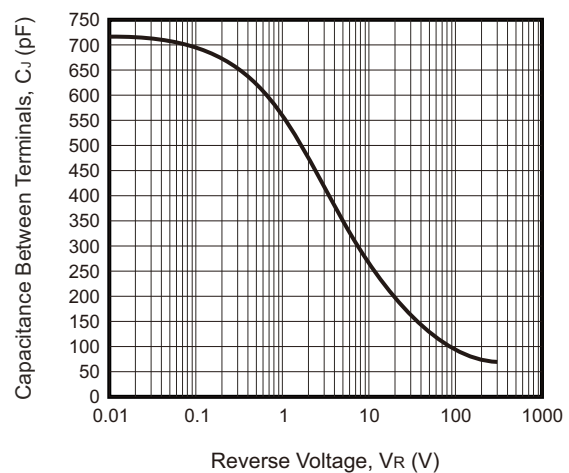
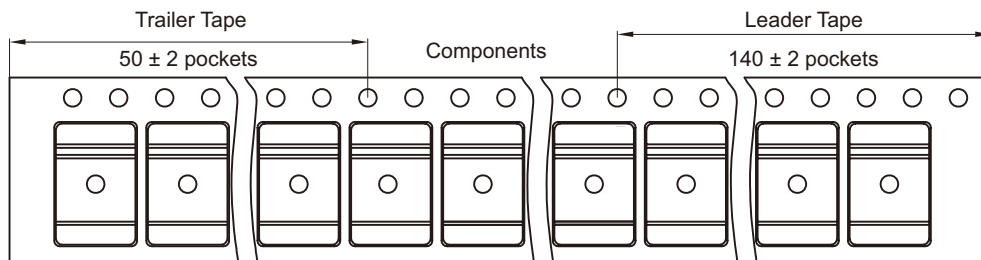
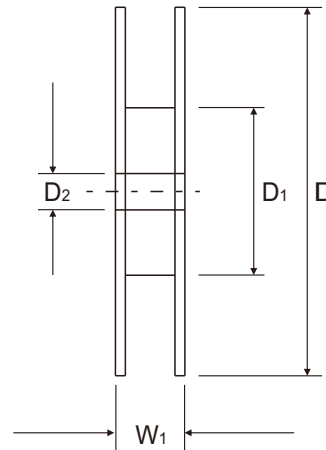
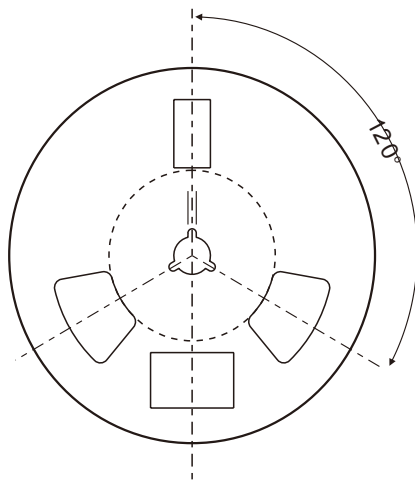
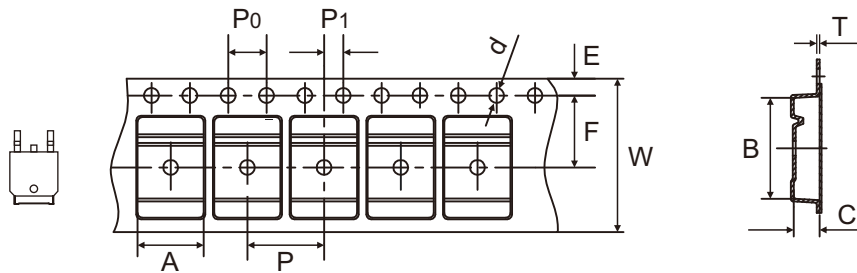

Fig.4 - Capacitance vs. Reverse Voltage



Company reserves the right to improve product design, functions and reliability without notice. REV:C

Reel Taping Specification



TO-252 (D-PAK)	SYMBOL	A	B	C	d	D	D1	D2
	(mm)	6.90 ± 0.10	10.50 ± 0.10	2.70 ± 0.10	1.55 ± 0.05	332 Max	100.00 ± 2.00	13.00 Min
	(inch)	0.272 ± 0.004	0.413 ± 0.004	0.106 ± 0.004	0.061 ± 0.002	13.071 Max	3.937 ± 0.079	0.512 Min

TO-252 (D-PAK)	SYMBOL	E	F	P	P ₀	P ₁	T	W	W ₁
	(mm)	1.75 ± 0.10	7.50 ± 0.10	8.00 ± 0.10	4.00 ± 0.10	2.00 ± 0.10	0.30 ± 0.05	16.00 ± 0.10	22.4 Max
	(inch)	0.069 ± 0.004	0.295 ± 0.004	0.315 ± 0.004	0.157 ± 0.004	0.079 ± 0.004	0.012 ± 0.002	0.630 ± 0.004	0.882 Max

Company reserves the right to improve product design, functions and reliability without notice. REV:C

Marking Code

Part Number	Marking Code	
CDBDSC10650-G	DSC10650	G3S06510C

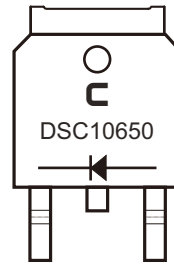

C = Comchip Logo

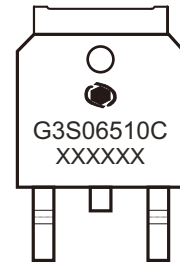

xxxxxx = Control code

Suggested P.C.B. PAD Layout

SIZE	TO-252 / DPAK	
	(mm)	(inch)
A	4.57	0.180
B	1.20	0.047
C	5.80	0.228
D	5.85	0.230
E	2.00	0.079

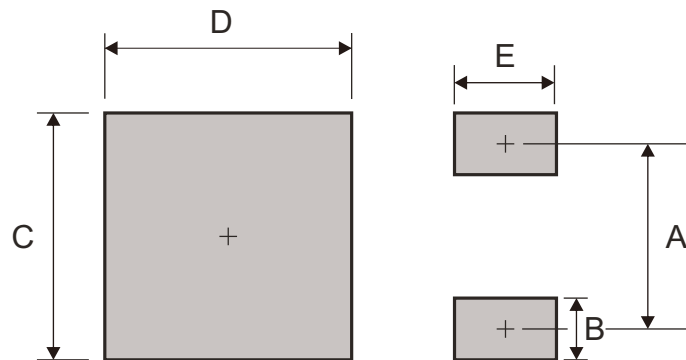

Note: 1. The pad layout is for reference purpose only.

Standard Packaging

Case Type	REEL PACK	
	REEL (pcs)	REEL SIZE (inch)
TO-252/D-PAK	2,500	13