

THIS DRAWING IS UNPUBLISHED. RELEASED FOR PUBLICATION 2018  
 © COPYRIGHT 2018 BY TYCO ELECTRONICS JAPAN G.K. ALL RIGHTS RESERVED.

REVISIONS				
P	LTR	DESCRIPTION	DATE	APVD
K		REVISED PER ECR-16-006694	19MAY2016	K.K E.T
L		REVISED PER ECR-18-000718	19JAN2018	M.J E.I

1-178128-3: AS SHOWN.  
 REFER TO SHEET 1 FOR 2,3,4POS.

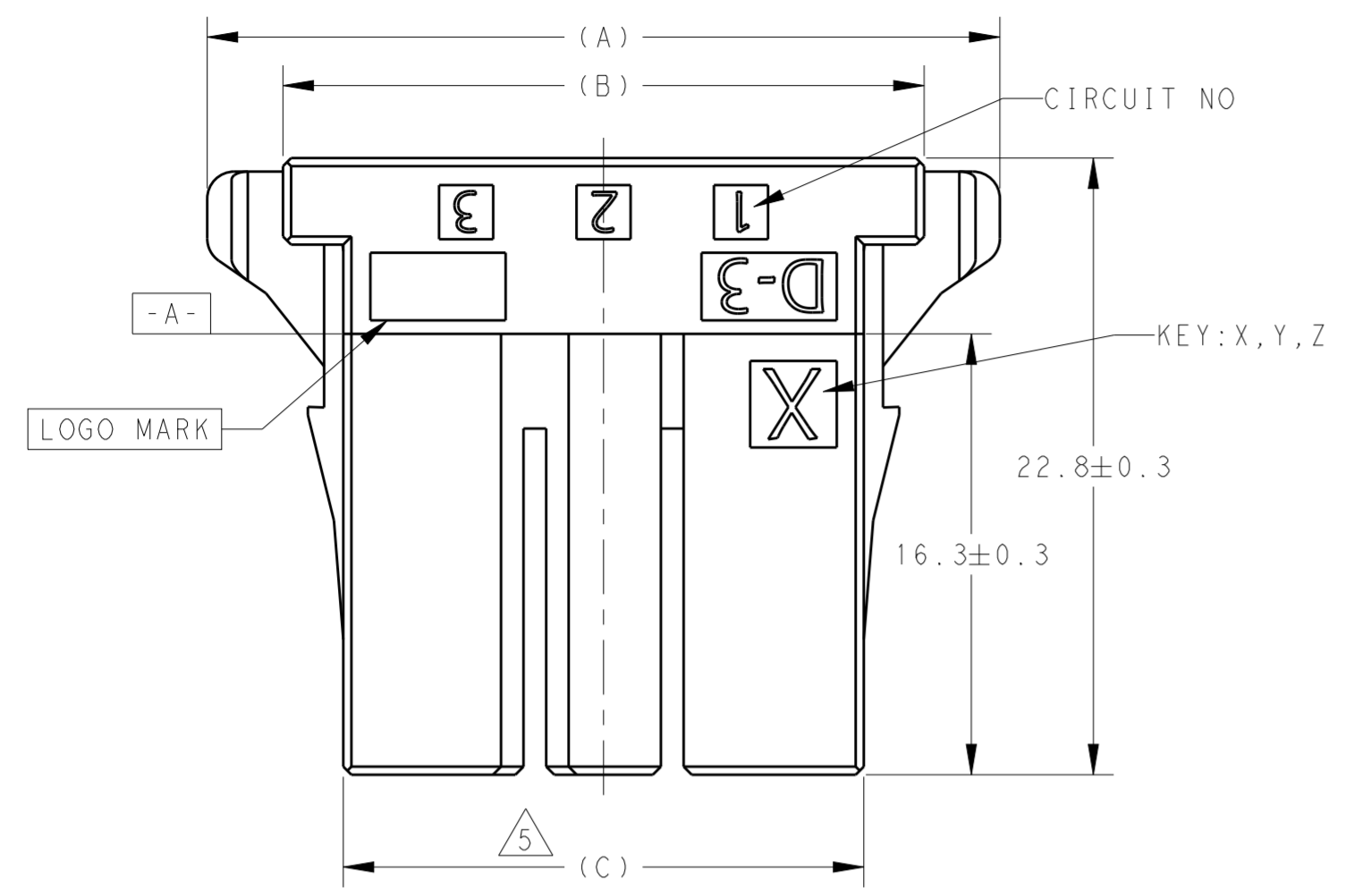

- 1 MATERIAL: GLASS FILLED THERMO PLASTIC, POLYESTER. COLOR: BLACK.
- 2 NOTE DELETED.
- 3 PRODUCT SPEC: 108-5349.
- 4 THE SHAPE, SIZE AND POSITION OF THE CHARACTER SHOW THE OUTLINE THEY DON'T SHOW DETAILS
- 5 THIS DIMENSION MUST BE MEASURED AT -A- OF HSG.

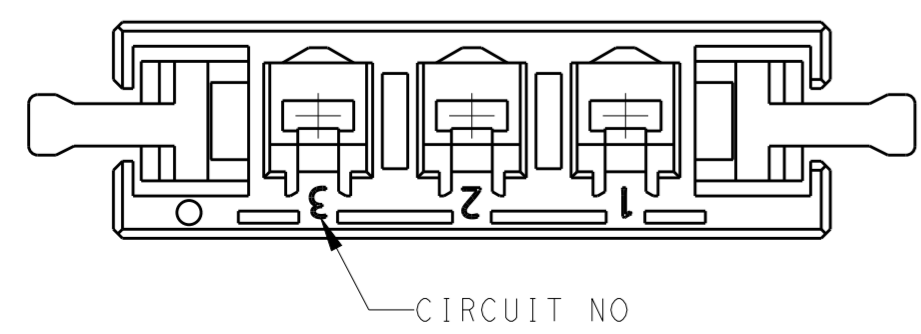
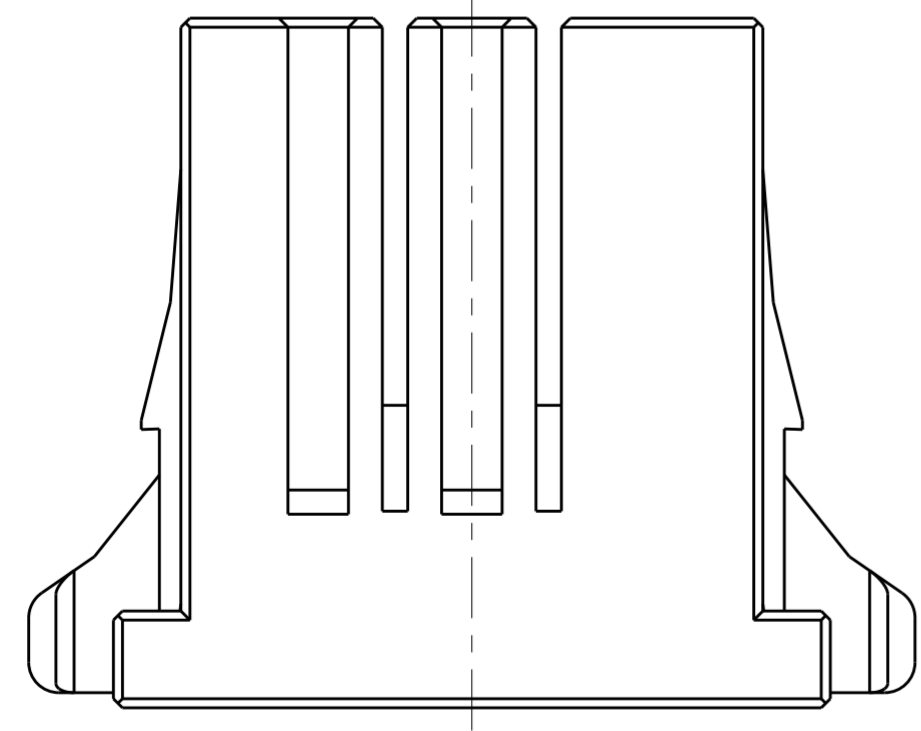
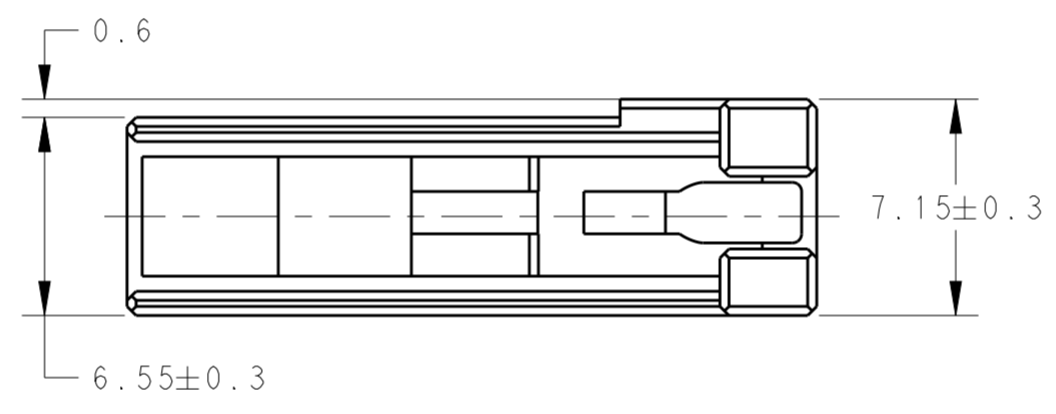
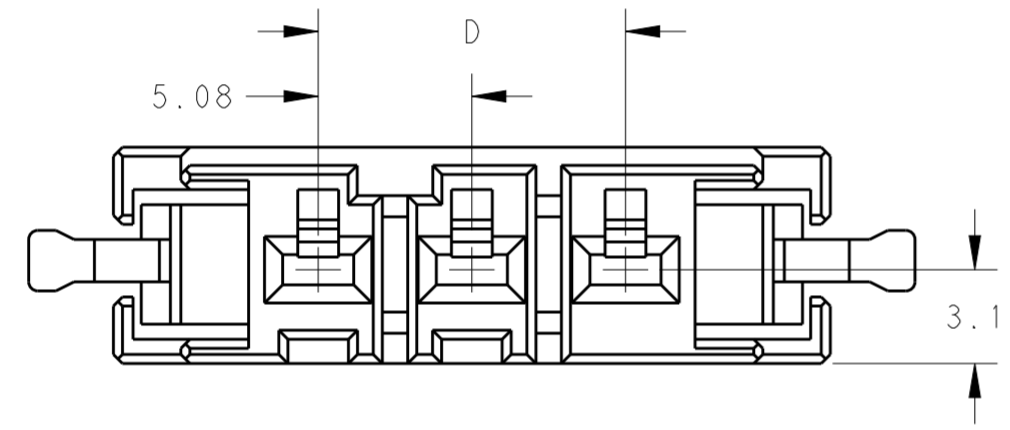

	Y	15.24	24.32	29.18	34.78	2-178128-4
	X	15.24	24.32	29.18	34.78	1-178128-4
	Z	10.16	19.24	24.10	29.7	3-178128-3
	Y	10.16	19.24	24.10	29.7	2-178128-3
	X	10.16	19.24	24.10	29.7	1-178128-3
	Y	5.08	14.16	19.02	24.62	2-178128-2
	X	5.08	14.16	19.02	24.62	1-178128-2
KEYING LOCATION	KEYING	D	C	B	A	PART NO

THIS DRAWING IS A CONTROLLED DOCUMENT.

DIMENSIONS: mm	TOLERANCES UNLESS OTHERWISE SPECIFIED:	DWN N. MATSUBARA 01DEC93	TE Connectivity NAME DYNAMIC D-3200, 5.08 PITCH RECEPTACLE HOUSING(KEY: X,Y) SIZE CAGE CODE DRAWING NO RESTRICTED TO A200779 C-178128
	0 PLC ±	CHK S. MANABE 13DEC95	
	1 PLC ±0.2	APVD S. MANABE 13DEC95	
	2 PLC ±0.25	PRODUCT SPEC 108-5349	
	3 PLC ±0.3	APPLICATION SPEC -	WEIGHT -
	4 PLC ±	CUSTOMER DRAWING	SCALE 4:1 SHEET 1 OF 2 REV L
MATERIAL	ANGLES ±3°		
	FINISH -		

THIS DRAWING IS UNPUBLISHED. RELEASED FOR PUBLICATION 2018  
 © COPYRIGHT 2018 BY TYCO ELECTRONICS JAPAN G.K. ALL RIGHTS RESERVED.

REVISIONS				
P	LTR	DESCRIPTION	DATE	APVD
-	-	SEE SHEET 1	-	-

1-178128-5: AS SHOWN.  
 REFER TO SHEET 2 FOR 5,6 POS.

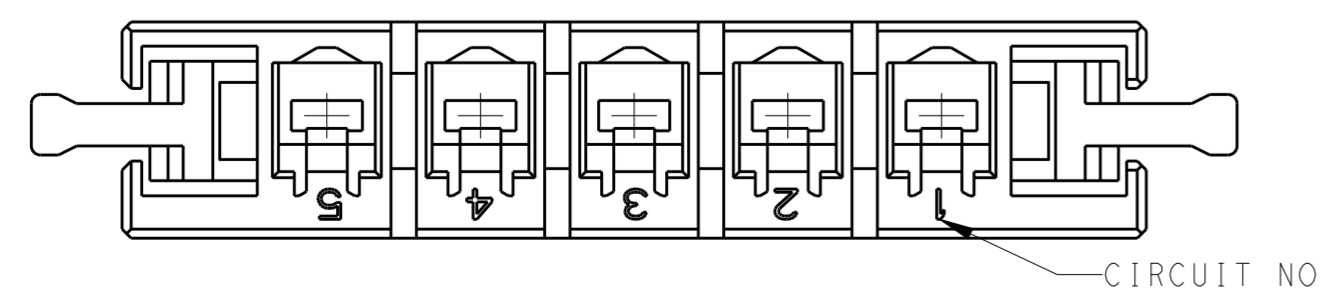
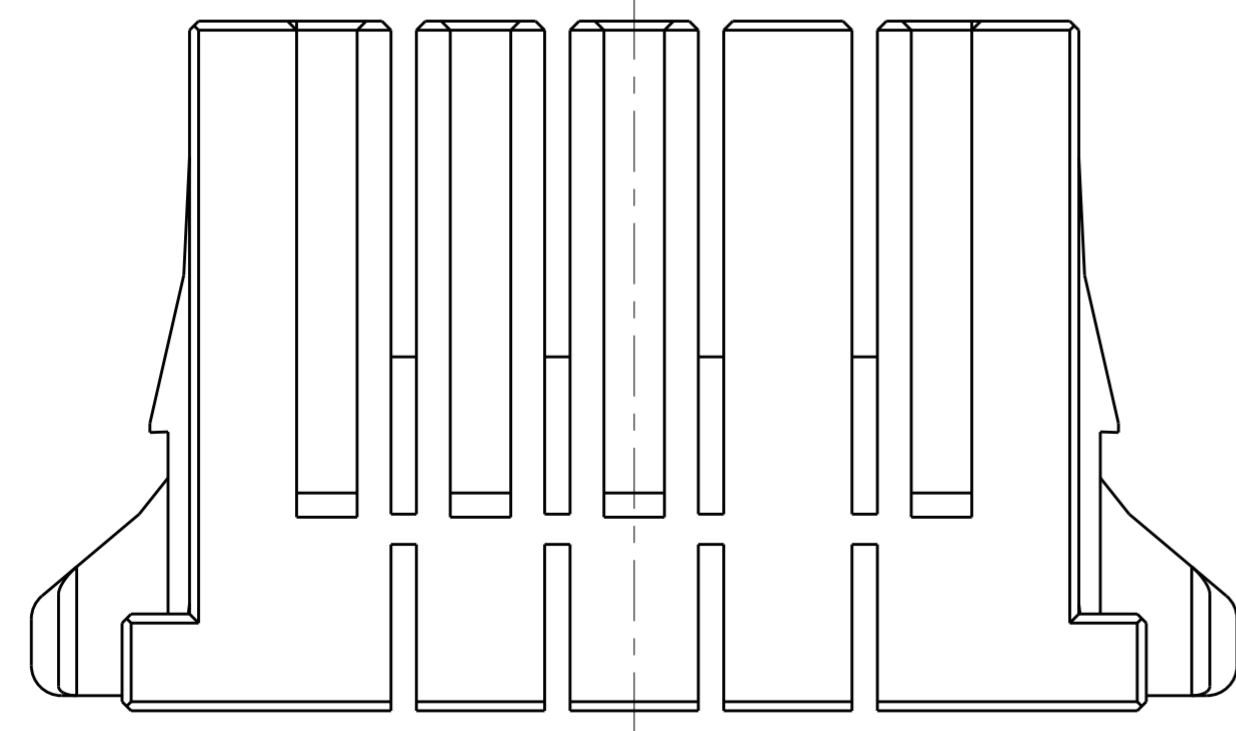
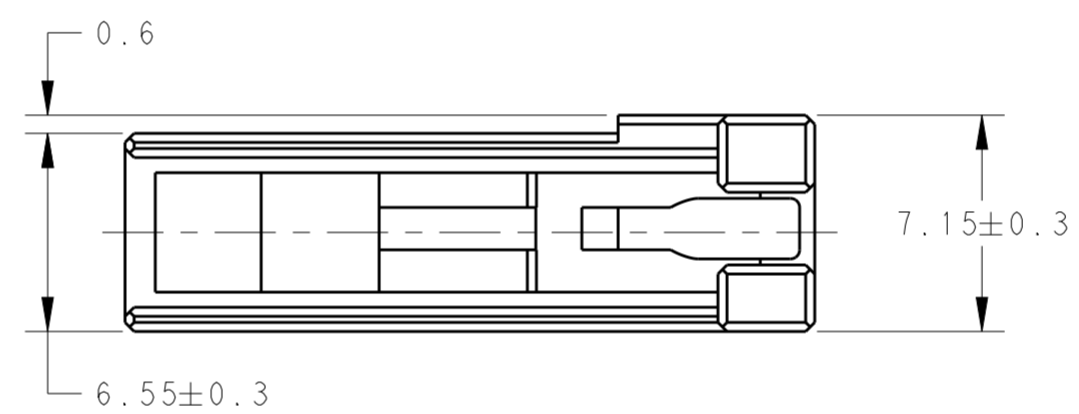
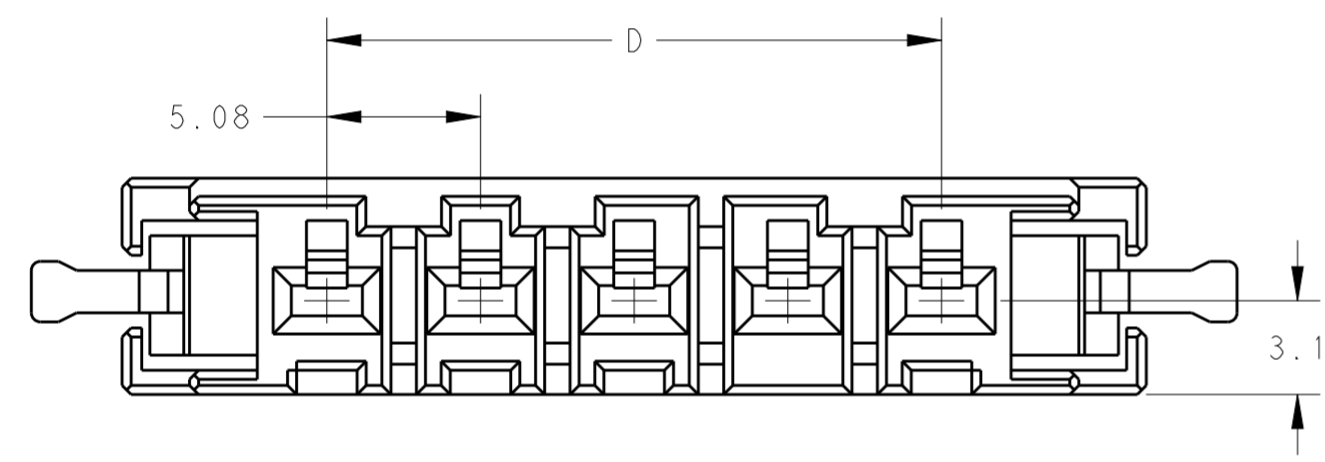
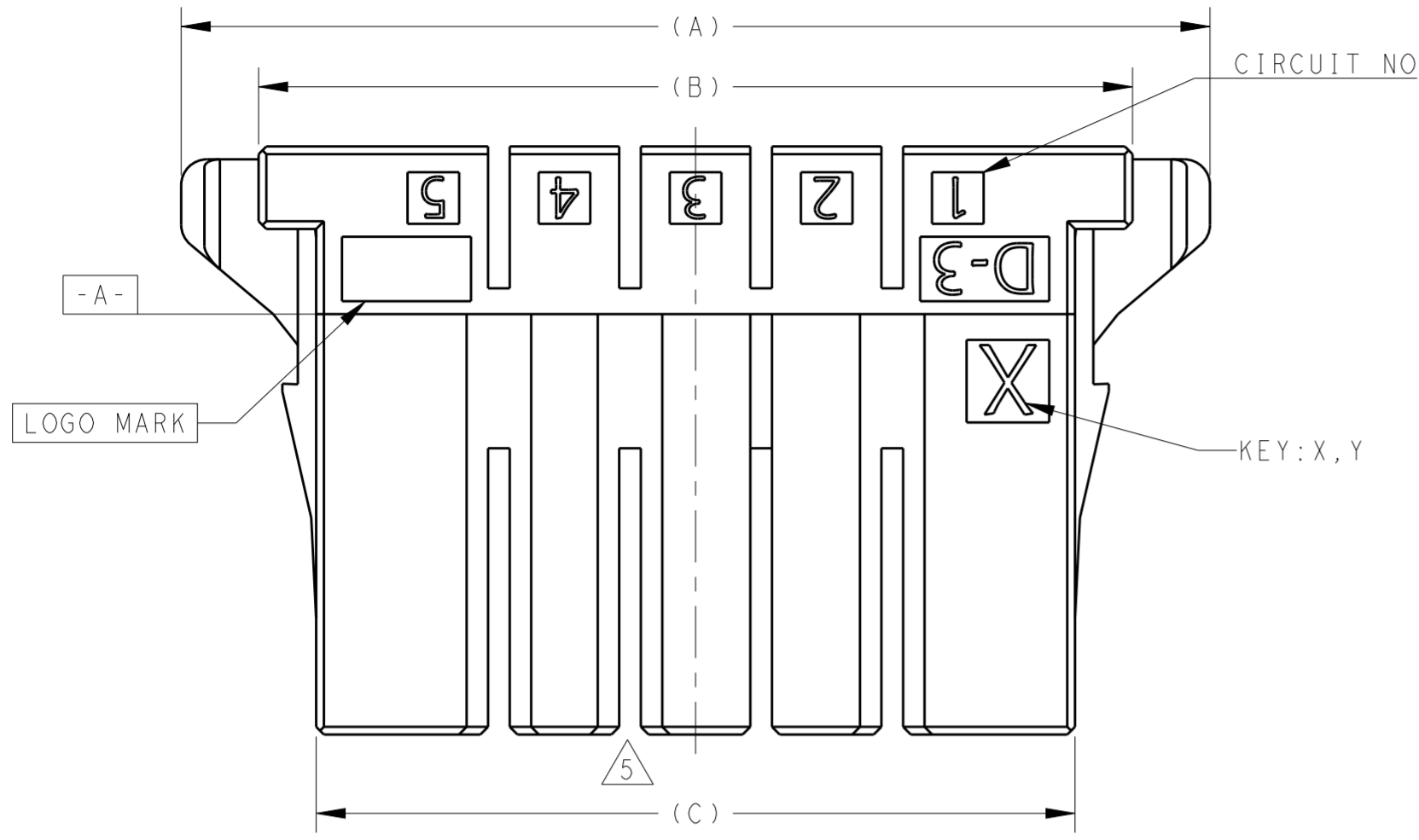

	Y	25.4	34.48	39.34	44.94	2-178128-6
	X	25.4	34.48	39.34	44.94	1-178128-6
	Y	20.32	29.4	34.26	39.86	2-178128-5
	X	20.32	29.4	34.26	39.86	1-178128-5
KEYING LOCATION	KEYING	D	C	B	A	PART NO

THIS DRAWING IS A CONTROLLED DOCUMENT.		DWN SEE SHEET 1	TE Connectivity			
DIMENSIONS: mm		CHK SEE SHEET 1				
TOLERANCES UNLESS OTHERWISE SPECIFIED:		APVD SEE SHEET 1	NAME DYNAMIC D-3200, 5.08 PITCH RECEPTACLE HOUSING(KEY: X,Y)			
0 PLC ±		PRODUCT SPEC SEE SHEET 1	SIZE	CAGE CODE	DRAWING NO	RESTRICTED TO
1 PLC ± SEE SHEET 1		APPLICATION SPEC	A200779	C-178128		
2 PLC ±			SCALE	SHEET	OF	REV
3 PLC ±			4:1	2	2	L
4 PLC ±						
ANGLES ±		WEIGHT				
FINISH						
MATERIAL SEE SHEET 1		CUSTOMER DRAWING				

# Mouser Electronics

Authorized Distributor

Click to View Pricing, Inventory, Delivery & Lifecycle Information:

[TE Connectivity:](#)

[1-178128-6](#)