

Pin Cylinders

2 auto switches can be mounted on a cylinder, even with the $\varnothing 4$ bore size (5 mm stroke).



Double acting / **Series CJP2**

One-touch fitting can be connected.

(Panel mount type)

$\varnothing 2$ one-touch fitting, miniature fitting, and speed controller can be connected.

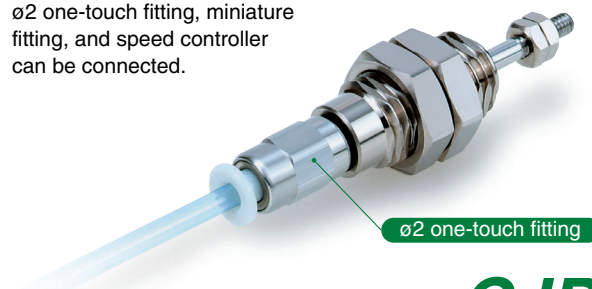

Single acting / **Series CJP**



Series CJP2/CJP

Small and Light

Double acting / **Series CJP2**

- Full length: Shortened by 6 to 9.5 mm. **Scale: 100%**
- Weight: Reduced by 55 to 65%

New aluminum body is light weight compared with the conventional CJP series.
(Compared with the basic model CJP cylinder without auto switch)

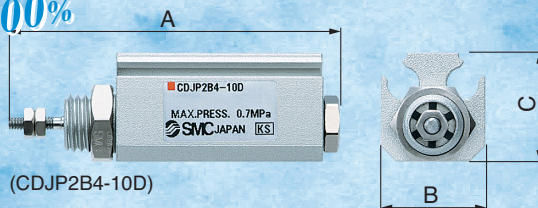

(CDJP2B4-10D)

Dimensions

Unit: mm

Bore size	A	B	C
4	29 + stroke (34 + stroke)	14	14.5
6	33 + stroke (38 + stroke)	14	16.5
10	39.5 + stroke (44.5 + stroke)	15	19
16	43.5 + stroke (48.5 + stroke)	20	24.5

* (): Dimension for built-in magnet type

Weight

Unit: g

Stroke	Bore size (mm)			
	4	6	10	16
5	11	16	27	42
10	13	18	29	46
15	15	21	32	50
20	17	23	35	54
25	—	25	37	58
30	—	—	40	63
35	—	—	43	67
40	—	—	45	71

Single acting / **Series CJP**

Panel mount type (CJPB4-5)

Scale: 100%

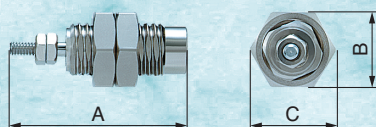

Embedded type (CJPS4-5)

Scale: 100%

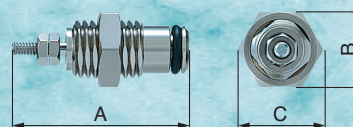

Dimensions

Unit: mm

Bore size	A			B	C
	5 st	10 st	15 st		
4	23.5	31.5	39.5	10	11.5
6	27.5	34.5	41.5	12	13.9
10	32.5	39	46	19	22
15	37.5	43.5	50	27	31

Weight

Unit: g

Stroke (mm)	Bore size (mm)			
	4	6	10	15
5	10	10.6	28	75
10	13	13.1	33	82
15	15	15.6	38	92

Variation

Series	Action	Bore size (mm)	Standard stroke (mm)	Mounting ^{Note 2)}
CJP2	Double acting, Single rod	4	5, 10, 15 (20) ^{Note 1)}	Basic Flange Foot Clevis Trunnion
		6	5, 10, 15, 20, 25	
		10	5, 10, 15, 20, 25, 30, 35, 40	
		16	5, 10, 15, 20, 25, 30, 35, 40	

Series	Action	Bore size (mm)	Standard stroke (mm)	Mounting
CJP	Single acting, spring return	4	5, 10, 15	Panel mount type, Embedded type
		6	5, 10, 15	
		10	5, 10, 15	
		15	5, 10, 15	

Note 1) A stroke of 20 is available with a standard product only. Note 2) Bore size of $\phi 4$ is available with basic mounting only.

Related Products



$\phi 2$ Speed Controller
Series AS



Pin Cylinder: Double Acting, Single Rod

Series CJP2

ø4, ø6, ø10, ø16

How to Order

Standard CJP2 **F** **10** - **15** **D** - **-** - **-**

Built-in magnet CDJP2 **F** **10** - **15** **D** - **-** - **M9B** **S** - **-**

With auto switch (Built-in magnet)

Mounting

Symbol	Mounting	Standard	Built-in magnet
B	Basic	●	●
F	Flange	●	●
L	Foot	●	●
D	Clevis	●	●
T	Trunnion	●	●

* Bore size of 4 mm is available with basic mounting only.
* Mounting bracket is shipped together (but not assembled).

Bore size

4	4 mm
6	6 mm
10	10 mm
16	16 mm

Cylinder standard stroke (mm)

ø4	5, 10, 15, (20) ^{Note}
ø6	5, 10, 15, 20, 25
ø10, ø16	5, 10, 15, 20, 25, 30, 35, 40

Note) A stroke of 20 is available with a standard product only.

Number of auto switches

-	2 pcs.
S	1 pc.

Auto switch

-	Without auto switch (Built-in magnet)
---	---------------------------------------

* For the applicable auto switch model, refer to the below table.
* Auto switches are shipped together, (but not assembled).

Rod end thread

-	With thread
B	Without thread

Double acting

Applicable Auto Switches / For detailed auto switch specifications, refer to page 17 through to 21.

Type	Special function	Electrical entry	Indicator light	Wiring (Output)	Load voltage		Auto switch model		Lead wire length (m)*				Pre-wired connector	Applicable load		
					DC	AC	Electrical entry direction	Electrical entry direction	0.5 (-)	1 (M)	3 (L)	5 (Z)		IC circuit	Relay, PLC	
Reed switch	-	Grommet	Yes	3-wire (NPN equiv.)	—	5 V	—	A96V**	A96**	●	—	●	—	—	IC circuit	—
				2-wire	24 V	12 V	100 V	A93V**	A93**	●	—	●	—	—	—	Relay, PLC
					5 V, 12 V	100 V or less	A90V**	A90**	●	—	●	—	—	—	IC circuit	
Solid state switch	-	Grommet	Yes	3-wire (NPN)	24 V	5 V, 12 V	—	M9NV	M9N	●	—	●	○	○	IC circuit	Relay, PLC
				3-wire (PNP)				M9PV	M9P	●	—	●	○	○	IC circuit	
				2-wire				M9BV	M9B	●	—	●	○	○	—	
				3-wire (NPN)				M9NVV	M9NV	●	●	●	○	○	IC circuit	
				3-wire (PNP)				M9PVV	M9PV	●	●	●	○	○	IC circuit	
				2-wire				M9BVV	M9BV	●	●	●	○	○	—	
				3-wire (NPN)				M9NAV*1	M9NA*1	○	○	●	○	○	IC circuit	
				3-wire (PNP)				M9PAV*1	M9PA*1	○	○	●	○	○	IC circuit	
				2-wire				M9BAV*1	M9BA*1	○	○	●	○	○	—	

* Lead wire length symbols: 0.5 m - (Example) M9N
1 m M M9NWM
3 m L M9NL
5 m Z M9NZ

** The D-A9□(V) switch is not attachable to ø4.

* Auto switches marked with "○" are made to order specification.

* For details about auto switches with pre-wired connector, refer to SMC's "Best Pneumatics" catalogue.

* Auto switches are shipped together, (but not assembled).

Series CJP2



JIS Symbol

Double acting, Single rod

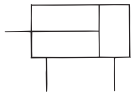

Made to Order: Individual Specifications

(For details, refer to page 11)

Symbol	Specifications
-X1666	Interchangeability of clevis and trunnion types



Made to Order

(For details, refer to page 22, 23.)

Symbol	Specifications
-XA□	Change of rod end type
-XB6	Heat resistant cylinder (150°C)
-XB7	Cold resistant cylinder
-XC19	Intermediate stroke (5 mm spacer)
-XC22	Fluororubber seals

Theoretical Output

(N)

Bore size (mm)	Operating direction	Operating pressure (MPa)		
		0.3	0.5	0.7
4	IN	2.8	4.7	6.6
	OUT	3.8	6.3	8.8
6	IN	6.4	10.6	14.8
	OUT	8.5	14.1	19.8
10	IN	19.8	33	46.2
	OUT	23.6	39.3	55
16	IN	51.8	86.4	121
	OUT	60.3	100.5	140.7



Moisture Control Tube IDK Series



When operating an actuator with a small diameter and a short stroke at a high frequency, the dew condensation (water droplet) may occur inside the piping depending on the conditions.

Simply connecting the moisture control tube to the actuator will prevent dew condensation from occurring. For details, refer to **the IDK series in the Best Pneumatics No. 6.**

Specifications

Action	Double acting, Single rod		
Maximum operating pressure	0.7 MPa		
Minimum operating pressure	ø4	0.15 MPa	
	ø6	0.12 MPa	
	ø10, ø16	0.06 MPa	
Proof pressure	1.05 MPa		
Ambient and fluid temperature	Without auto switch: -10 to 70°C (No freezing) With auto switch: -10 to 60°C (No freezing)		
Lubrication	Not required (Non-lube)		
Stroke length tolerance	+1.0 0		
Thread tolerance	JIS Class 2		
Rod end style	With thread/Without thread		
Piston speed	10 to 500 mm/s		
Cushion	Rubber bumper		
Mounting <small>(Note)</small>	Basic, Flange, Foot, Clevis, Trunnion		

Note) Bore size of ø4 is available with basic mounting only.

Standard Equipment Accessory

Accessory	Mounting nut (1 pc.)	Rod end nut (2 pcs.) (with thread)	Trunnion (with pin)
Mounting			
Basic	●	●	—
Flange	●	●	—
Foot	●	●	—
Clevis	—	●	—
Trunnion	—	●	●

Standard Stroke

Bore size (mm)	Stroke (mm)
4	5, 10, 15, 20 <small>Note)</small>
6	5, 10, 15, 20, 25
10	5, 10, 15, 20, 25, 30, 35, 40
16	5, 10, 15, 20, 25, 30, 35, 40

* 20 stroke of bore size 4 mm is standard type only.

Option

Bore size (mm)	6	10	16
Description			
Auto switch	D-A9□(V), D-M9□(V), D-M9□W(V)		
Single knuckle joint	I-P006A	I-P010A	I-P016A
Double knuckle joint (with pin)	Y-P006A	Y-P010A	Y-P016A

Mounting Bracket Part No.

Bore size (mm)	6	10	16
Bracket			
Flange	CP-F006A	CP-F010A	CP-F016A
Foot	CP-L006A	CP-L010A	CP-L016A
Trunnion (with pin)	CP-T006A	CP-T010A	CP-T016A

Weight

(g)

	Stroke (mm) Mounting	Bore size (mm)			
		4	6	10	16
Basic weight	5	11	16	27	42
	10	13	18	29	46
	15	15	21	32	50
	20	17	23	35	54
	25	—	25	37	58
	30	—	—	40	63
	35	—	—	43	67
	40	—	—	45	71
Bracket weight	Flange	—	5	6	16
	Foot	—	7	9	24
	Clevis	—	2	5	8
	Trunnion (with pin)	—	15	25	70
Additional weight for built-in magnet		2	3	5	7

Allowable Kinetic Energy

⚠ Caution

When driving an inertial load, operate the cylinder with a kinetic energy within the allowable value. The range in the chart below that is shown by bold solid lines indicates the relation between load weights and maximum driving speeds.

Bore size (mm)	4	6	10	16
Piston speed (m/s)	0.05 to 0.5			
Allowable kinetic energy (J)	0.75×10^{-2}	1.2×10^{-2}	2.5×10^{-2}	5.0×10^{-2}

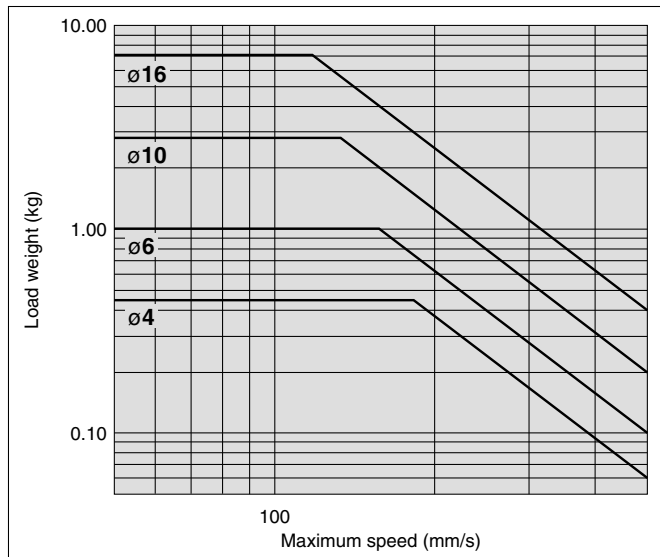

Allowable Lateral Load

Strictly observe the limiting range of lateral load on the piston rod. (Refer to the below graph.) If this product is used beyond the limits, it may shorten the machine life or cause damage.

Allowable lateral load

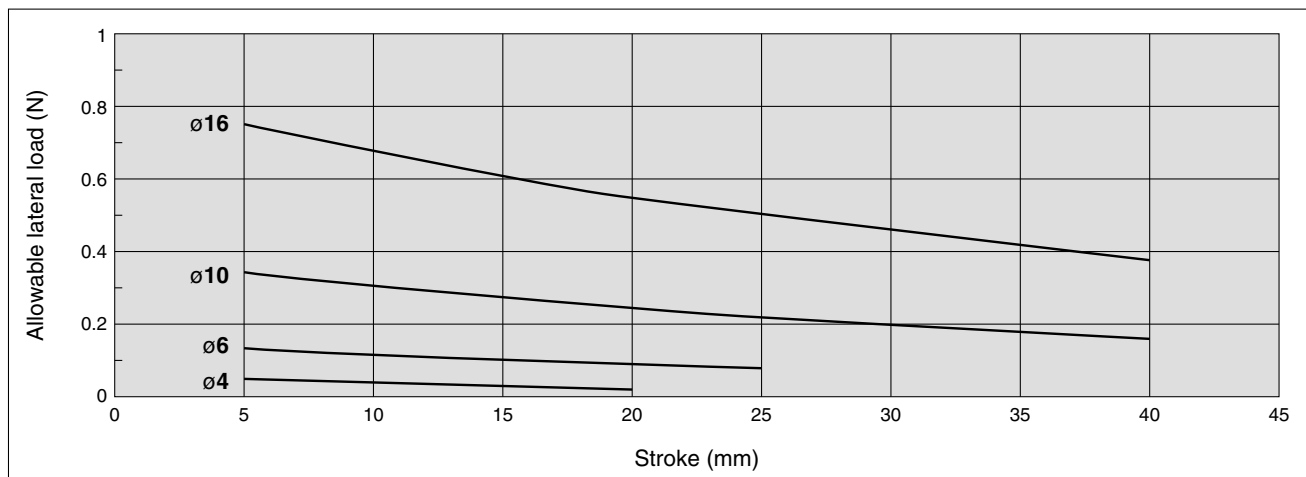
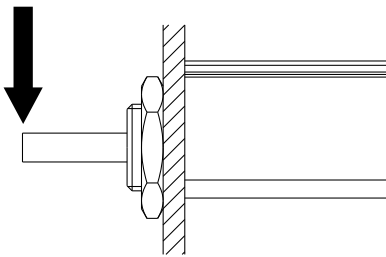

Series CJP2

Construction

C□JP2B4

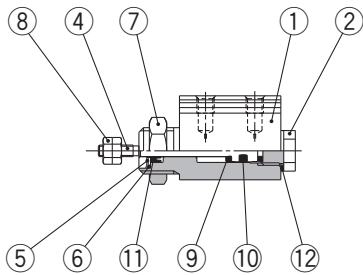

Built-in magnet

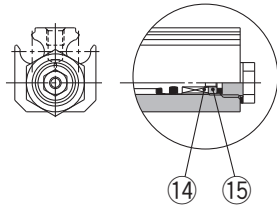

C□JP2B6

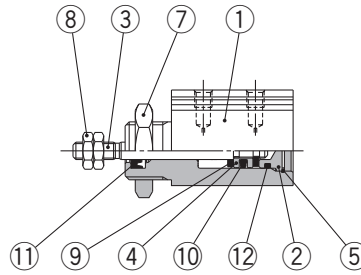

Built-in magnet

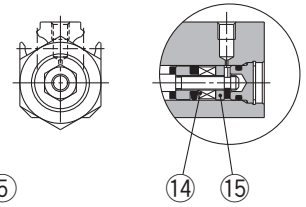

C□JP2B10, 16

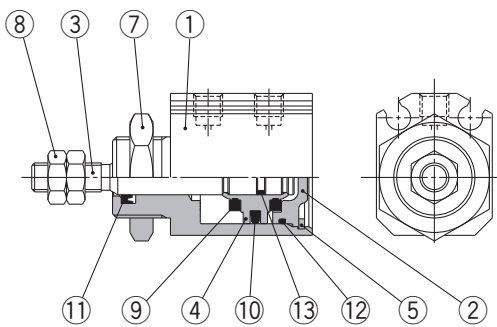

Built-in magnet

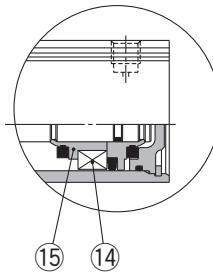

Component Parts

No.	Description	Material	Note	
1	Body	Aluminum alloy	Hard anodized	
2	Head cover	ø4, ø6, ø10	Brass	Electroless nickel plated
		ø16	Aluminum alloy	Chromated
3	Piston rod	Stainless steel		
4	Piston	ø4	Stainless steel	
		ø6, ø10	Brass	
		ø16	Aluminum alloy	Chromated
5	Snap ring	Tool steel	Phosphate coating	
6	Seal retainer	Special steel	Nickel plated	
7	Mounting nut	Brass	Electroless nickel plated	
8	Rod end nut	Steel	Nickel plated	
9	Bumper	Urethane rubber		
10	Piston seal	NBR		
11	Rod seal	NBR		
12	Gasket	ø4	Stainless steel + NBR	
		ø6, ø10, ø16	NBR	
13	Piston gasket	NBR		
14	Magnet	Magnetic material		
15	Magnet retainer	ø4, ø6, ø10	Brass	
		ø16	Aluminum alloy	Chromated

Replacement Parts: Seal Kit

Bore size (mm)	Kit no.	Contents
6	CJP2B6D-PS	Piston seal, Rod seal, Gasket, Grease pack (5 g)
10	CJP2B10D-PS	
16	CJP2B16D-PS	

* Seal kit includes above contents. Order the seal kit, based on each bore size.

Replacement Parts: Seal Kit

Standard

Bore size (mm)	Kit no.	Contents
6	CJP2B6D-PS	Set of left nos. ⑩, ⑪, ⑫.
10	CJP2B10D-PS	
16	CJP2B16D-PS	

* Seal kit includes a grease pack (5 g).

Order with the following part number when only the grease pack is needed.
Grease pack part number: GR-L-005 (5 g)

XB6/Heat-resistant cylinder (-10 to 150°C)

Bore size (mm)	Kit no.	Contents
6	CJP2B6D-XB6-PS	Set of left nos. ⑩, ⑪, ⑫.
10	CJP2B10D-XB6-PS	
16	CJP2B16D-XB6-PS	

* Seal kit includes a grease pack (5 g).

Order with the following part number when only the grease pack is needed.
Grease pack part number: GR-F-005 (5 g)

XB7/Cold-resistant cylinder

Bore size (mm)	Kit no.	Contents
6	CJP2B6D-XB7-PS	Set of left nos. ⑩, ⑪, ⑫.
10	CJP2B10D-XB7-PS	
16	CJP2B16D-XB7-PS	

* Seal kit includes a grease pack (5 g).

Order with the following part number when only the grease pack is needed.
Grease pack part number: GR-T-005 (5 g)

XC22/Fluororubber seal

Bore size (mm)	Kit no.	Contents
6	CJP2B6D-XC22-PS	Set of left nos. ⑩, ⑪, ⑫.
10	CJP2B10D-XC22-PS	
16	CJP2B16D-XC22-PS	

* Seal kit includes a grease pack (5 g).

Order with the following part number when only the grease pack is needed.
Grease pack part number: GR-L-005 (5 g)

Dimensions: Basic Mounting ($\phi 4$)

Without magnet: CJP2B4

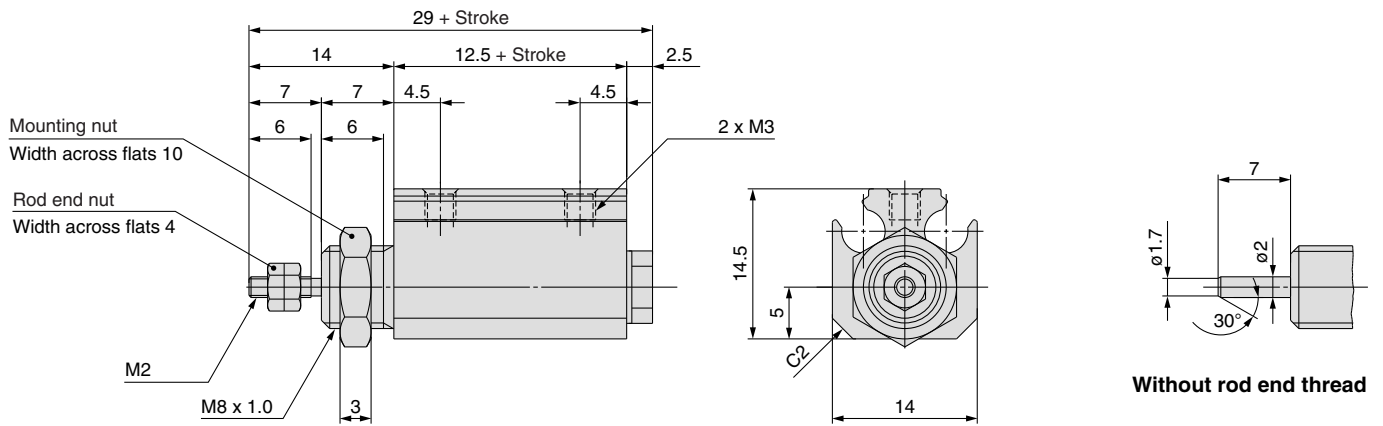

Built-in magnet: CDJP2B4

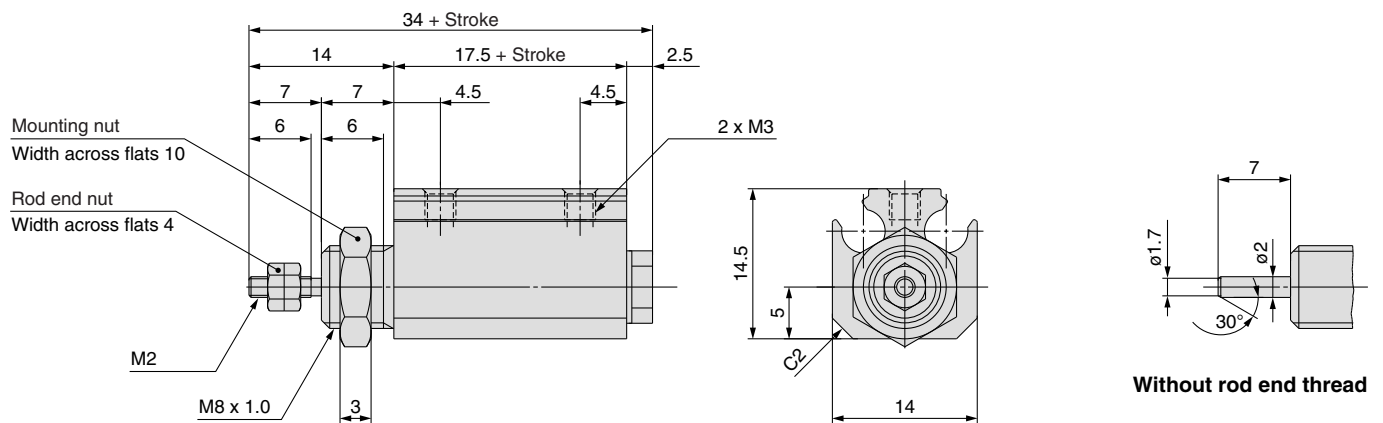

Series CJP2

Dimensions: Basic Mounting (ø6 to ø16)

Without magnet: CJP2B6 to 16

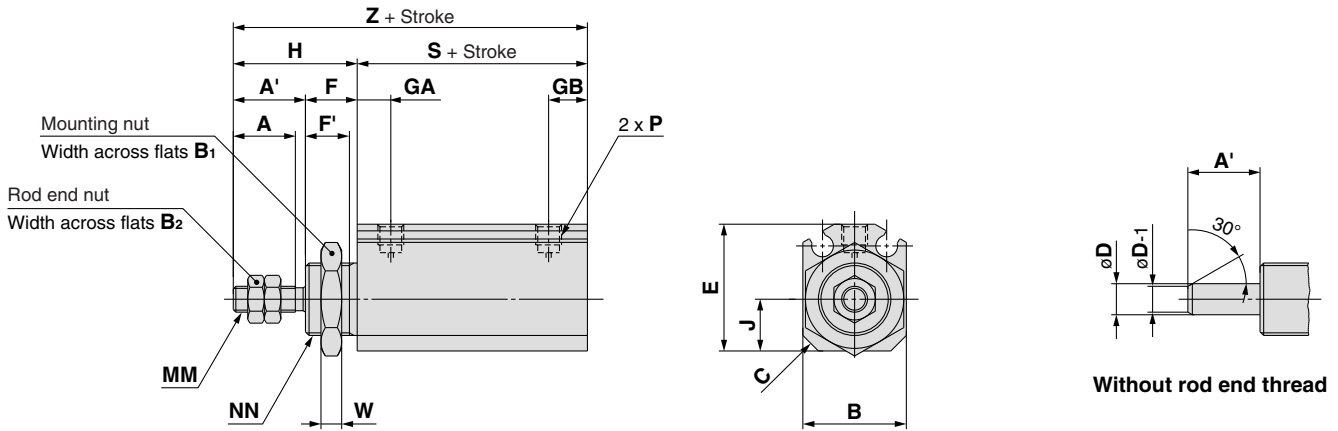

Symbol Bore size	(mm)																			
	A	A'	B	B ₁	B ₂	C	D	E	F	F'	GA	GB	H	J	MM	NN	P	S	W	Z
6	7	9	14	14	5.5	2	3	16.5	8	6.5	5.5	6.5	17	6	M3	M10 x 1.0	M3 x 0.5	16	3	33
10	10	12	15	17	7	2.5	4	19	8	6.5	6	7	20	7	M4	M12 x 1.0	M3 x 0.5	19.5	3	39.5
16	12	14	20	19	8	3	6	24.5	10	8.5	6.5	7.5	24	10	M5	M14 x 1.0	M5 x 0.8	19.5	4	43.5

Built-in magnet: CDJP2B6 to 16

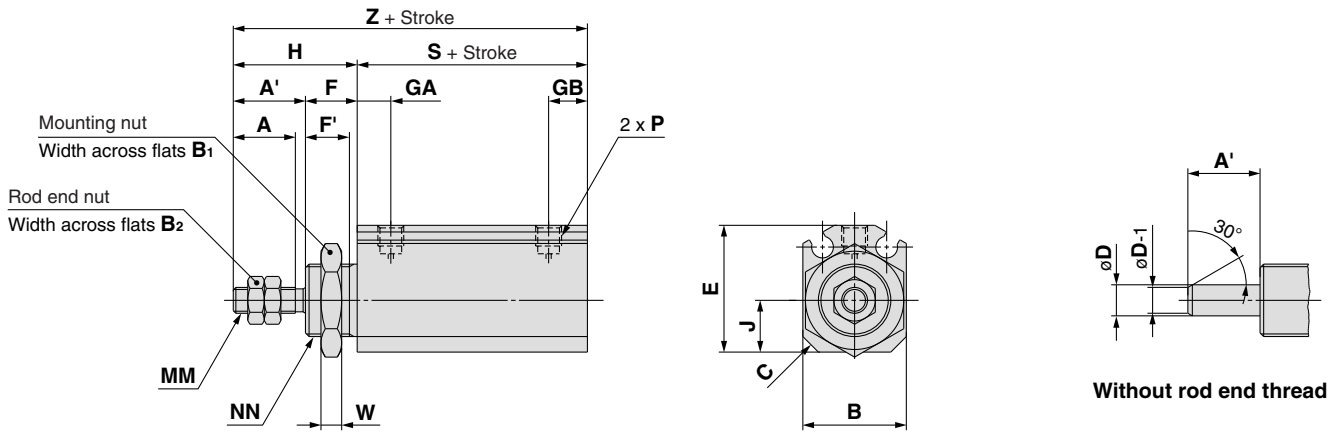

Symbol Bore size	(mm)																			
	A	A'	B	B ₁	B ₂	C	D	E	F	F'	GA	GB	H	J	MM	NN	P	S	W	Z
6	7	9	14	14	5.5	2	3	16.5	8	6.5	5.5	6.5	17	6	M3	M10 x 1.0	M3 x 0.5	21	3	38
10	10	12	15	17	7	2.5	4	19	8	6.5	6	7	20	7	M4	M12 x 1.0	M3 x 0.5	24.5	3	44.5
16	12	14	20	19	8	3	6	24.5	10	8.5	6.5	7.5	24	10	M5	M14 x 1.0	M5 x 0.8	24.5	4	48.5

Mounting Bracket Dimensions

Flange: C(D)JP2F6 to 16

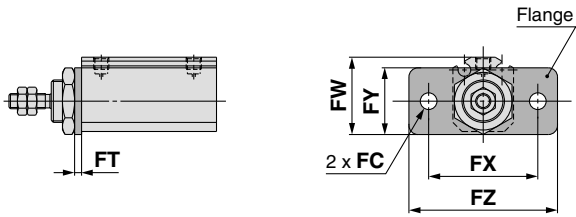

Flange

Symbol		(mm)					
Bore size	FC	FT	FW	FX	FY	FZ	
6	3.4	1.6	18.5	24	16	32	
10	4.5	1.6	21	28	18	37	
16	5.5	2.3	25.5	36	22	49	

* Other dimensions are the same as basic mounting.

Foot: C(D)JP2L6 to 16

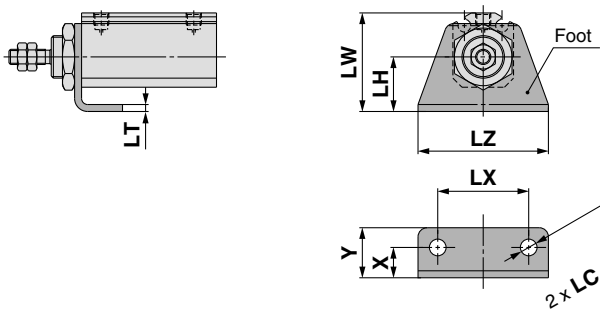

Foot

Symbol		(mm)							
Bore size	X	Y	LC	LH	LT	LW	LX	LZ	
6	6.5	10.5	3.4	11	1.6	21.5	20	28	
10	7	12	4.5	13	1.6	25	24	33	
16	10	16.5	5.5	18	2.3	32.5	30	43	

* Other dimensions are the same as basic mounting.

Clevis: C(D)JP2D6 to 16

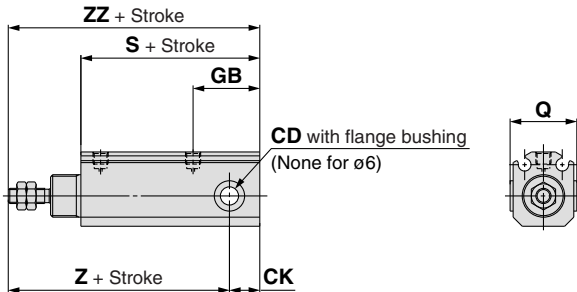

Clevis

Symbol		(mm)			
Bore size	CD	CK	GB	Q	
6	3 ^{+0.040} ₀	4	11.5	—	
10	5 ^{+0.065} ₀	6.5	18	17 ⁰ _{-0.5}	
16	6 ^{+0.065} ₀	10	22	22 ⁰ _{-0.5}	

Symbol		S		Z		ZZ	
Bore size		Without magnet	Built-in magnet	Without magnet	Built-in magnet	Without magnet	Built-in magnet
6		21	26	34	39	38	43
10		30.5	35.5	44	49	50.5	55.5
16		34	39	48	53	58	63

Trunnion: C(D)JP2T6 to 16

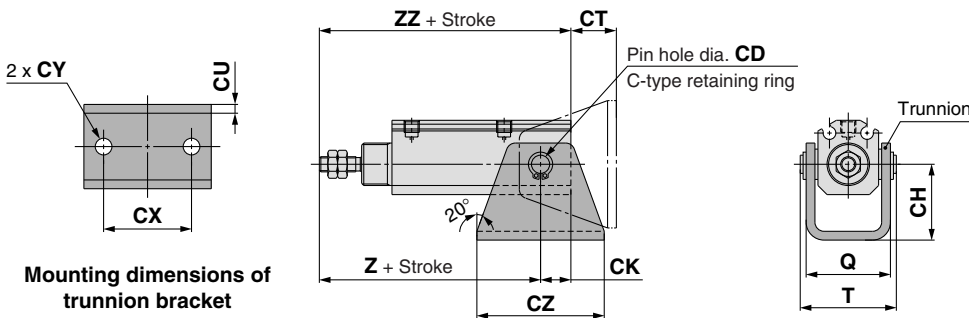

Rotation angle

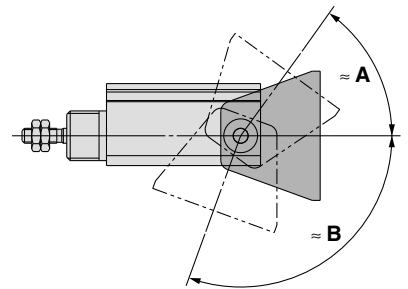

Trunnion

Symbol		(mm)												
Bore size	CD	CH	CK	CT	CU	CX	CY	CZ	Q	T	Z		ZZ	
											Without magnet	Built-in magnet	Without magnet	Built-in magnet
6	3	16	4	12	1.6	18	3.4	26	18.5	20.4	34	39	38	43
10	5	20	6.5	13.5	1.6	24	4.5	33	20.5	23.9	44	49	50.5	55.5
16	6	25	10	15	2.9	29	5.5	42	28	31.7	48	53	58	63

Applicable bore	ø6	ø10	ø16
≈ A	54°	62°	55°
≈ B	110°	110°	102°

* Provided as guidelines.
The values are varied depending on the condition.

Series CJP2

Accessory Bracket Dimensions

Single knuckle joint

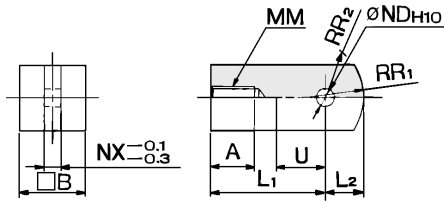

Material: Rolled steel

Part no.	Applicable bore size (mm)	A	B	L ₁	L ₂	MM	ND _{H10}	NX	R ₁	R ₂	U
I-P006A	6	5	6	12	3.5	M3	3 ^{+0.040} ₀	3	5	4	5
I-P010A	10	6.5	10	16	5.5	M4	5 ^{+0.048} ₀	5	8	6.3	7
I-P016A	16	7	12	19	7	M5	6 ^{+0.048} ₀	6	10	7.8	9

Double knuckle joint

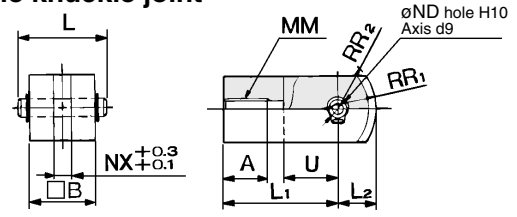

* Knuckle pin and retaining ring are included.

Material: Rolled steel

Part no.	Applicable bore size (mm)	A	B	L	L ₁	L ₂	MM	ND _{d9}	ND _{H10}	NX	R ₁	R ₂	U
Y-P006A	6	5	6	9	12	3.5	M3	3 ^{-0.020} _{-0.045}	3 ^{+0.040} ₀	3	5	4	5
Y-P010A	10	6.5	10	13.6	16	5.5	M4	5 ^{-0.030} _{-0.060}	5 ^{+0.048} ₀	5	8	6.3	7
Y-P016A	16	7	12	15.8	19	7	M5	6 ^{-0.030} _{-0.060}	6 ^{+0.048} ₀	6	10	7.8	9

Knuckle pin

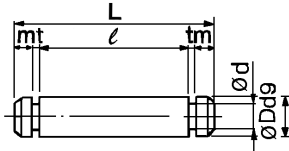

Material: Stainless steel

Part no.	Applicable bore size (mm)	D d9	L	d	l	m	t	Retaining* ring
IY-P006	6	3 ^{-0.020} _{-0.045}	9	2.85	6.2	0.75	0.65	Clip C-type 3
IY-P010	10	5 ^{-0.030} _{-0.060}	13.6	4.8	10.2	1	0.7	C-type 5
IY-P015	16	6 ^{-0.030} _{-0.060}	15.8	5.7	12.2	1	0.8	C-type 6

* Included

Trunnion pin

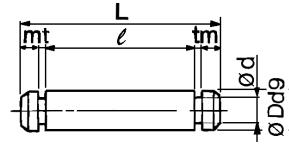

Material: Stainless steel

Part no.	Applicable bore size (mm)	D d9	L	d	l	m	t	Retaining* ring
CT-P006	6	3 ^{-0.020} _{-0.045}	20.4	2.85	17.6	0.75	0.65	Clip C-type 3
CT-P010	10	5 ^{-0.030} _{-0.060}	23.9	4.8	20.5	1	0.7	C-type 5
CT-P015	16	6 ^{-0.030} _{-0.060}	31.7	5.7	28.1	1	0.8	C-type 6

* Included

Mounting nut

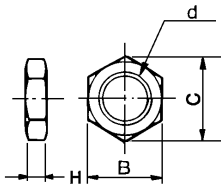

Material: Brass

Part no.	Applicable bore size (mm)	d	H	B	C
SNPS-004	4	M8 x 1.0	3	10	11.5
SNP-006	6	M10 x 1.0	3	14	16.2
SNP-010	10	M12 x 1.0	3	17	19.6
SNP-015	16	M14 x 1.0	4	19	21.9

Rod end cap

Flat type: CJ-CF□□□

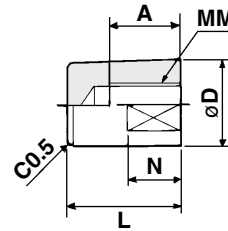

Round type: CJ-CR□□□

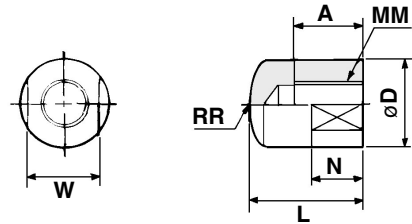

Rod end nut

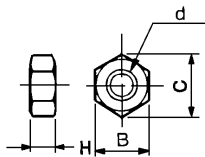

Material: Iron

Part no.	Applicable bore size (mm)	d	H	B	C
NTJ-004	4	M2	1.6	4	4.6
NTP-006	6	M3	1.8	5.5	6.4
NTP-010	10	M4	2.4	7	8.1
NTP-015	16	M5	3.2	8	9.2

Material: Polyacetal

Part no.		Applicable bore size (mm)	A	D	L	MM	N	RR	W
Flat type	Round type								
CJ-CF004	CJ-CR004	4	5	6	9	M2	3	6	5
CJ-CF006	CJ-CR006	6	6	8	11	M3	5	8	6
CJ-CF010	CJ-CR010	10	8	10	13	M4	6	10	8
CJ-CF016	CJ-CR016	16	10	12	15	M5	7	12	10

Auto Switch Proper Mounting Position (Detection at Stroke End) and Its Mounting Height

D-A9□(V), D-M9□(V), D-M9□W(V), D-M9□A(V)

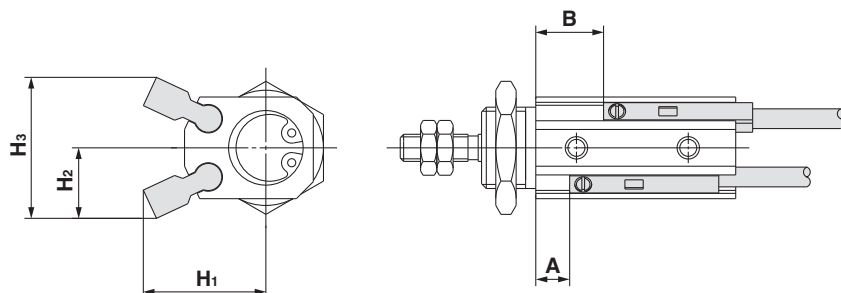

Applicable Auto Switches: D-A9□, D-A9□V

(mm)

Bore size	A (When detecting at extended stroke end position)	B (When detecting at retracted stroke end position)								H ₁	H ₂	H ₃
		5 st	10 st	15 st	20 st	25 st	30 st	35 st	40 st			
ø4	—	—	—	—	—	—	—	—	—	—	—	—
ø6	1	6	11	16	21	26	—	—	—	13	10	20
ø10	1	6	11	16	21	26	31	36	41	16	9.5	19
ø16	1	6	11	16	21	26	31	36	41	18	12	24

Applicable Auto Switches: D-M9□, D-M9□V, D-M9□W, D-M9□WV, D-M9□A, D-M9□AV

(mm)

Bore size	A (When detecting at extended stroke end position)	B (When detecting at retracted stroke end position)								H ₁	H ₂	H ₃
		5 st	10 st	15 st	20 st	25 st	30 st	35 st	40 st			
ø4	4	9	14	19	—	—	—	—	—	14.5	11.5	23
ø6	5	10	15	20	25	30	—	—	—	15	11.5	23
ø10	5	10	15	20	25	30	35	40	45	18	10.5	21
ø16	5	10	15	20	25	30	35	40	45	20	13	26

Note) Only adjust the setting position after confirming the auto switch is properly activated.

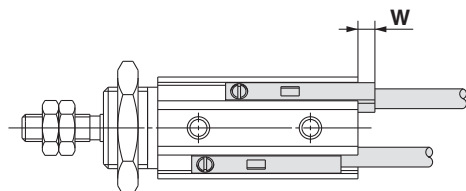

Mounting: Basic, Flange, Foot

(mm)

Auto switch model	D-M9□ D-M9□W	D-M9□V D-M9□WV	D-M9□A	D-M9□AV	D-A90 D-A96 D-A9□V	D-A93
Bore size	W					
ø4	6	4	8	6	—	—
ø6	6	4	8	6	2	4.5
ø10	2.5	0.5	4.5	2.5	0	1
ø16	2.5	0.5	4.5	2.5	0	1

Mounting: Clevis, Trunnion

(mm)

Auto switch model	D-M9□ D-M9□W	D-M9□V D-M9□WV D-A9□ D-A9□V	D-M9□A	D-M9□AV
Bore size	W			
ø4	—	—	—	—
ø6	1	0	3	2
ø10	0	0	2	2
ø16	0	0	2	2

* 0 (zero) denotes the auto switch does not protrude from the end surface.

Series CJP2 Auto Switch Mounting

Operating Range

Auto switch model	Bore size (mm)			
	4	6	10	16
D-A9□(V)	—	5	6	7
D-M9□(V)	2.5	2.5	3	3.5
D-M9□W(V)				
D-M9□A(V)				

* Since the operating range is provided as a guideline including hysteresis, it cannot be guaranteed (assuming approximately ±30% dispersion). It may vary substantially depending on an ambient environment.

Minimum Stroke for Auto Switch Mounting

No. of auto switches mounted	Applicable auto switch model (mm)	
	D-M9□, D-M9□V	D-M9□W, D-M9□WV D-M9□A, D-M9□A(V) D-A9□, D-A9□V
1	5	5
2	5	10

Mounting and Moving Auto Switches

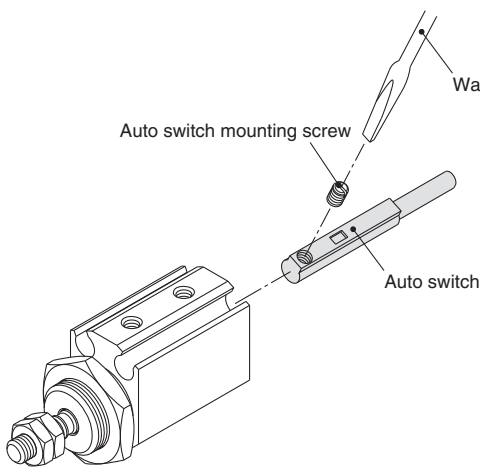

- ① Fit an auto switch into the auto switch mounting groove to set it roughly to the mounting position for an auto switch.
- ② After reconfirming the detecting position, tighten the auto switch mounting screw* to secure the auto switch.
- ③ Modification of the detecting position should be made in the condition of ①.

* When tightening an auto switch mounting screw, use a watchmaker's screwdriver with a handle of approximately 5 to 6 mm in diameter.
(Use a tightening torque of approximately 0.10 to 0.20 N·m.)

Tightening torque for auto switch mounting screw (N·m)

Auto switch model	Tightening torque
D-A9□(V)	0.10 to 0.20
D-M9□(V) D-M9□W(V) D-M9□A(V)	0.05 to 0.15

⚠ Specific Product Precautions

Before handling auto switches, refer to pages 8 to 12 for Auto Switches Precautions.

⚠ Caution

1. If auto switch cylinders are used in parallel, keep the distance between cylinders in accordance with the below chart.

Mounting Pitch (mm)

Auto switch model	Bore size (mm)			
	4	6	10	16
D-A9□(V)	—	20	25	30
D-M9□(V) D-M9□W(V) D-M9□A(V)	25	25	30	35

Use caution not to use them, getting closer than the specified pitch. Otherwise, it may cause auto switch to malfunction.

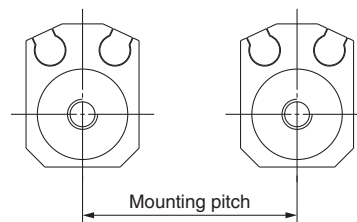

Series CJP2

Made to Order: Individual Specifications

Please contact SMC for detailed dimensions, specifications and lead times.



1 Clevis / Trunnion Type Mounting Interchangeable

Symbol
-X1666

CJP2 series standard model no. — X1666

• Clevis / Trunnion type mounting interchangeable (Former CJP)

Specifications

Applicable series	CJP2
Bore size	ø6, ø10, ø16

Other specifications	Same as standard type.
----------------------	------------------------

- * ø6 is available for both standard and built-in magnet types.
- * ø10 and ø16 are available for the standard type (The built-in magnet type is interchangeable.)

Dimensions

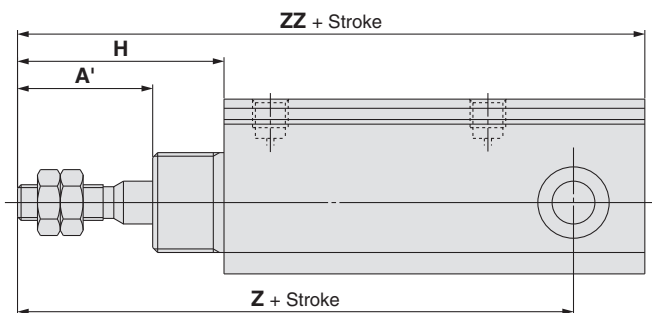

Bore size(mm)	A'	H	Z	ZZ
6	18.5 (13.5)	26.5 (21.5)	43.5	47.5
10	17	25	49	55.5
16	19	29	53	63

- * Dimensions other than above are same as basic type.
- (): For the built-in magnet type



Series CJP2 Specific Product Precautions

Be sure to read this before handling the products. Please consult with SMC for the use other than the specifications.

Mounting

⚠ Caution

Mounting nut maximum tightening torque and panel width

- ① Do not apply more torque than the maximum torque range when mounting the cylinder or bracket. Also, do not attach a panel with a thickness beyond the specified range.

Cylinder bore size	Thread	Maximum tightening torque (N·m)	A dimension maximum value (mm)
ø4	M8 x 1	6.2	3
ø6	M10 x 1	12.5	4
ø10	M12 x 1	21.0	4
ø16	M14 x 1	34.0	5

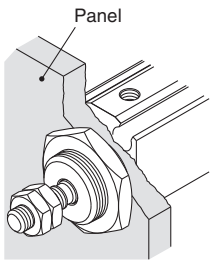

Panel mounting

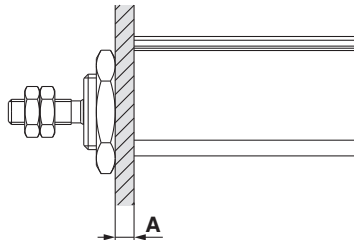

Panel maximum thickness

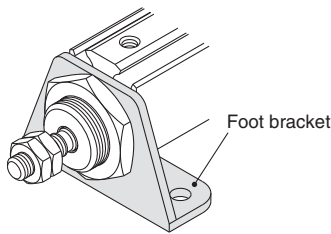

Foot mounting

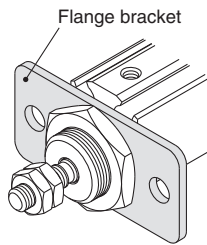

Flange mounting

- ② Do not apply more tightening torque than the below specified range when attaching a load on the rod end, rod end cap, single or double knuckle joint.

Applicable bore size	Thread size	Maximum tightening torque (N·m)
ø4	M2 x 0.4	0.1
ø6	M3 x 0.5	0.3
ø10	M4 x 0.7	0.8
ø16	M5 x 0.8	1.6

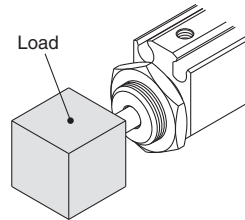

Rod end load mounting

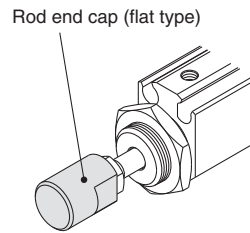

Rod end cap (flat type) mounting

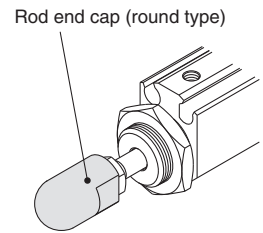

Rod end cap (round type) mounting

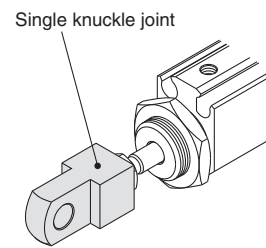

Single knuckle joint mounting

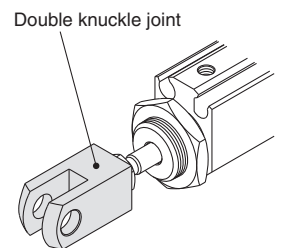

Double knuckle joint mounting

Piping

⚠ Caution

The piping port size of CJ2□6 and CJP2□10 is M3 x 0.5. If using piping tube O.D. ø6, piping is possible on M3 One-touch fittings (applicable tube O.D. ø4) when used with a reducer (ex. KQ2R04-06 <plug-in type>, KQ2L04-06 <plug-in elbow type>).

* For details of One-touch fittings, refer to Best Pneumatics No. 7.

Disassembly and Maintenance

⚠ Caution

Snap ring installation / removal

- To replace seals or grease the cylinder during maintenance, use an appropriate pair of pliers (tool for installing a C-type retaining ring for hole). After re-installing the cylinder, make sure that the retaining ring is placed securely in the groove before supplying air.
- To remove and install the retaining ring for the knuckle pin or the trunnion pin, use an appropriate pair of pliers (tool for installing a C-type retaining ring for hole). In particular, use a pair of ultra-mini pliers, for removing and installing the retaining rings on the ø6 cylinder. Do not disassemble the CJP4 cylinder. Do not loosen or remove the head cover.

Pin Cylinder: Single Acting, Spring Return

Series CJP

ø4, ø6, ø10, ø15

A short stroke miniature cylinder with a shorter overall length.

The installation space can be significantly reduced because this cylinder can be recessed directly into a machine body or installed on a panel. Thus, the machine can be made more compact.

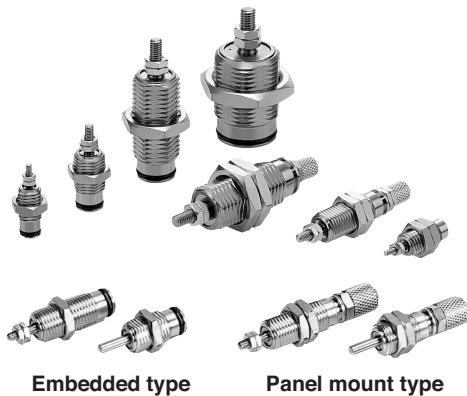

JIS Symbol

Single acting, Spring return



Made to Order
(For details, refer to page 22, 23.)

Symbol	Specifications
XC17	Pin cylinder with rod quenched
XC22	Fluoro rubber seals

Mounting

Panel mount type Embedded type

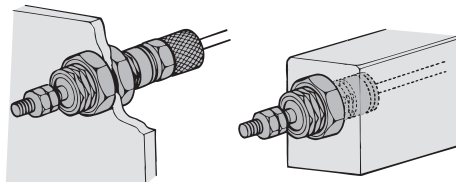

Moisture Control Tube IDK Series



When operating an actuator with a small diameter and a short stroke at a high frequency, the dew condensation (water droplet) may occur inside the piping depending on the conditions.

Simply connecting the moisture control tube to the actuator will prevent dew condensation from occurring. For details, refer to **the IDK series in the Best Pneumatics No. 6.**

How to Order

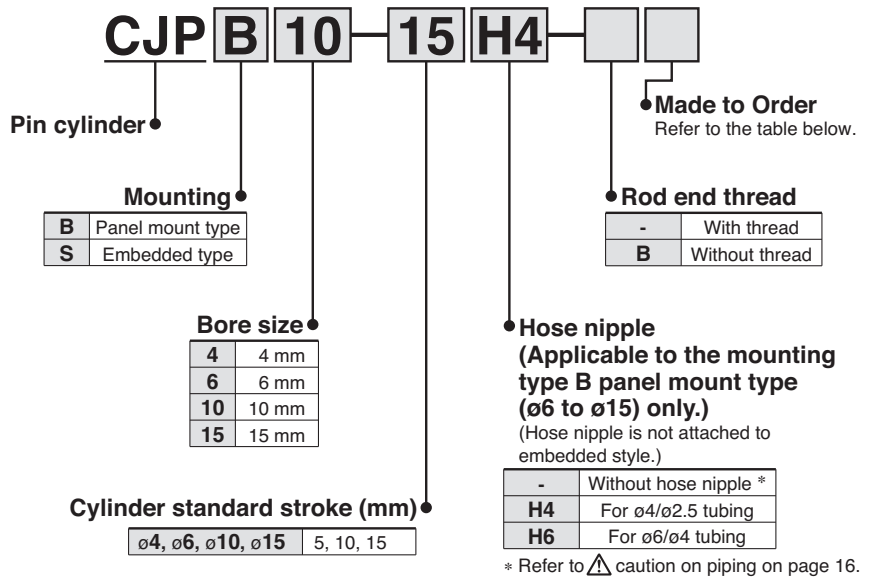

Specifications

Action	Single acting, Spring return	
Maximum operating pressure	0.7 MPa	
Minimum operating pressure	ø4	0.3 MPa
	ø6	0.2 MPa
	ø10, ø15	0.15 MPa
Proof pressure	1.05 MPa	
Ambient and fluid temperature	-10 to 70°C (No freezing)	
Lubrication	Not required (Non-lube)	
Piston speed	50 to 500 mm/s	
Cushion	None	
Stroke length tolerance	+1.0 0	
Thread tolerance	JIS Class 2	
Rod end style	With thread/Without thread	
Mounting	Panel mount type	Embedded type
Accessory (Standard equipment)	Standard equipment	Mounting nut (2) Rod end nut (2) *
	Option	Hose nipple (Except ø4)
		Mounting nut (1) Gasket (1) Rod end nut (2) *

* When rod end is threaded.

Application Examples

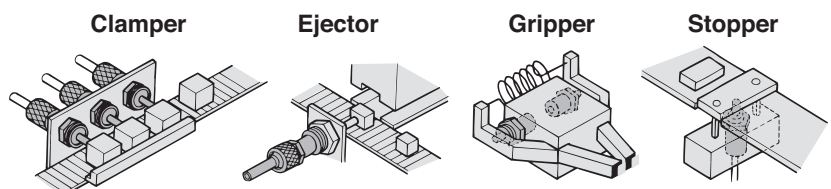

Series CJP

Standard Stroke

Bore size (mm)	Stroke (mm)
4	5, 10, 15
6	5, 10, 15
10	5, 10, 15
15	5, 10, 15

Weight

(g)

Model	Stroke (mm)		
	5	10	15
CJP□4	10	13	15
CJP□6	10.6	13.1	15.6
CJP□10	28	33	38
CJP□15	72	82	92

* Weight of hose nipple (4 g) for panel mounting is excluded.

Theoretical Output

(N)

Bore size (mm)	Operating direction	Operating pressure (MPa)		
		0.3	0.5	0.7
4	OUT	0.97	3.48	6.00
	IN	1.0		
6	OUT	4.56	10.2	15.9
	IN	1.42		
10	OUT	17.6	33.3	49.0
	IN	2.45		
15	OUT	42.2	77.5	113
	IN	4.41		

Spring Reaction Force

(N)

Bore size (mm)	Stroke (mm)	Retracted side	Extended side
4	5, 10, 15	2.80	1.00
6	5, 10, 15	3.92	1.42
10	5, 10, 15	5.98	2.45
15	5, 10, 15	10.80	4.41

* Same spring force for each stroke.

Hose Nipple Dedicated for Panel Mount Type

(With fixed orifice)

Applicable tubing	Part no.
For ø4/ø2.5 tubing	CJ-5H-4
For ø6/ø4 tubing	CJ-5H-6

Construction (Not possible to disassemble.)

Panel mount type

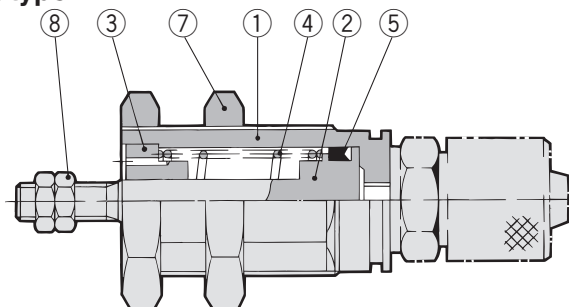

Embedded type

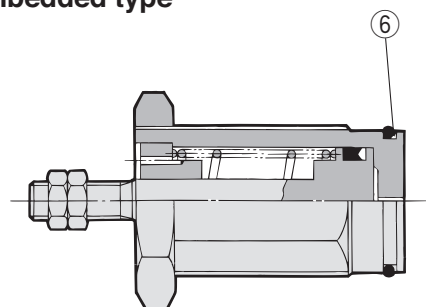

Component Parts

No.	Description	Material	Note
1	Cover	Brass	Electroless nickel plated
2	Piston	Stainless steel	
3	Collar	Oil-impregnated sintered alloy	ø4 Brass + Electroless nickel plated
			ø6, ø10 Bronze
4	Return spring	Steel wire	Zinc chromated
5	Piston seal	NBR	
6	Gasket	NBR	Special product (O-ring) embedded type only
7	Mounting nut	Brass	Electroless nickel plated
8	Rod end nut	Steel	Nickel plated

Mounting nut

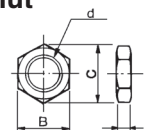

Material: Brass

Part no.	Applicable bore size (mm)	d	H	B	C
SNPS-004	4	M8 x 1.0	3	10	11.5
SNPS-006	6	M10 x 1.0	3	12	13.9
SNPS-010	10	M15 x 1.5	4	19	22
SNPS-015	15	M22 x 1.5	5	27	31

Dedicated Nut / Part No.

Description	Bore size (mm)	4	6	10	15
	Mounting nut		SNPS-004	SNPS-006	SNPS-010
Rod end nut		NTJ-004	NTP-006	NTP-010	NTP-015

Rod end nut

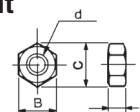

Material: Steel

Part no.	Applicable bore size (mm)	d	H	B	C
NTJ-004	4	M2	1.6	4	4.6
NTP-006	6	M3	1.8	5.5	6.4
NTP-010	10	M4	2.4	7	8.1
NTP-015	15	M5	3.2	8	9.2

Replacement Parts / Gasket

Bore size (mm)	Order no.	Contents
4	CJPS4-G	Above no. ⑥
6	CJPS6-G	
10	CJPS10-G	
15	CJPS15-G	

* For the plug mounting type
 * Since gaskets (10 pcs./set) do not include a grease pack (10 g), order it separately.
Grease pack part number: GR-S-010 (10g)

* Dedicated for the embedded type.

Allowable Kinetic Energy

⚠ Caution

When driving an inertial load, operate the cylinder with a kinetic energy within the allowable value. The range in the chart below that is shown by bold solid lines indicates the relation between load weights and maximum driving speeds.

Bore size (mm)	4	6	10	15
Piston speed (m/s)	0.05 to 0.5			
Allowable kinetic energy (J)	0.5×10^{-3}	3×10^{-3}	8×10^{-3}	19×10^{-3}

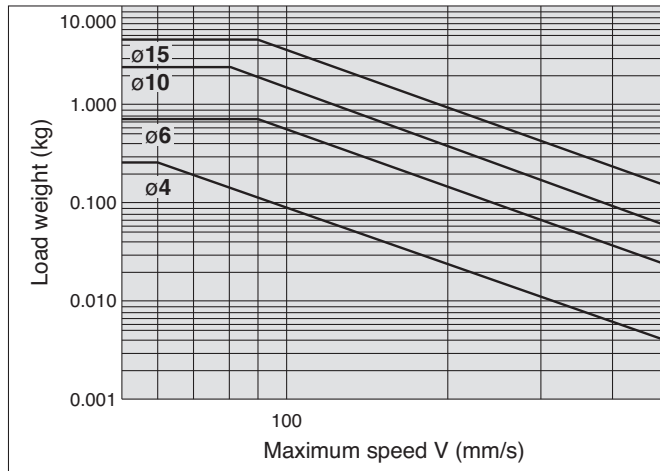

Allowable Lateral Load

Strictly observe the limiting range of lateral load on the piston rod. (Refer to the below graph.) If this product is used beyond the limits, it may shorten the machine life or cause damage.

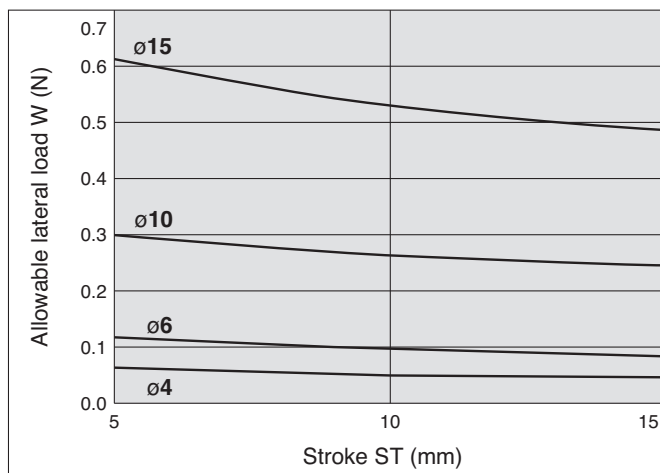

Series CJP

Recommended Mounting Hole Dimensions for Embedded Type

When embedded

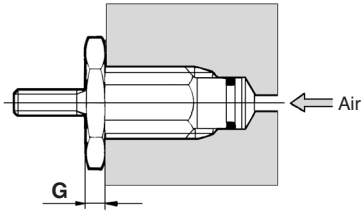

Machining dimensions for mounting

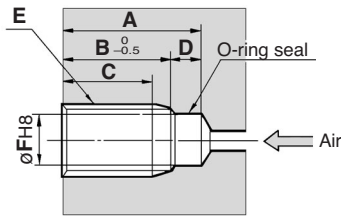

Bore size (mm)	Stroke	A	B	C	D	E	F	G	(mm)
4	5	12	8.5	6	3.5	M8 x 1.0	6.5	3	
	10	20	16.5	14					
	15	28	24.5	22					
6	5	16	12.5	10	3.5	M10 x 1.0	8.5	3	
	10	23	19.5	17					
	15	30	26.5	24					
10	5	17	13.5	10.5	3.5	M15 x 1.5	12	4	
	10	23.5	20	17					
	15	30.5	27	24					
15	5	19	14.5	11.5	4.5	M22 x 1.5	19	5	
	10	25	20.5	17.5					
	15	31.5	27	24					

Note) E and ϕF should be machined in a concentric manner.

Dimensions: Panel Mount Type

CJPB4

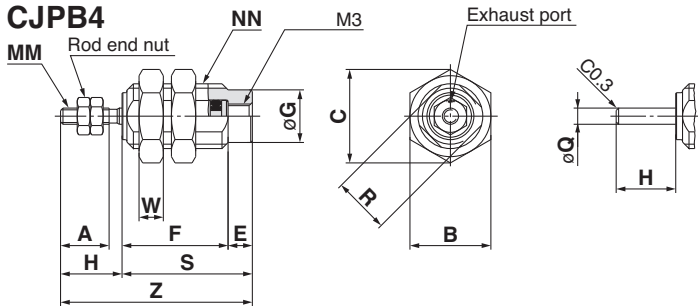

CJPB6, 10, 15

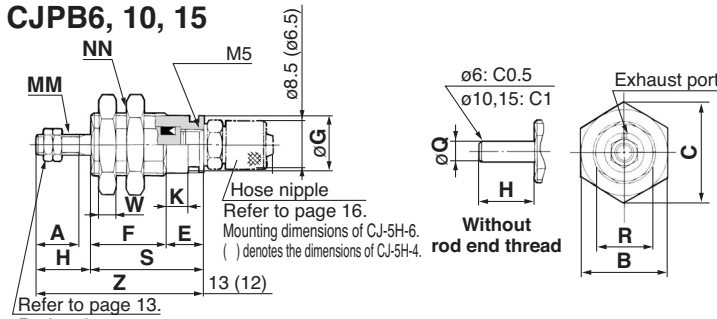

Bore size (mm)	A	B	C	E	F			G	H	K	MM
					5 st	10 st	15 st				
4	6	10	11.5	3	13	21	29	6.5	7.5	—	M2
6	7	12	13.9	6	12.5	19.5	26.5	8.5	9	3.5	M3
10	10	19	22	6	14.5	21	28	12	12	3.5	M4
15	12	27	31	7	16.5	22.5	29	19	14	4.2	M5

Bore size (mm)	NN	R	S			W	Z			Q
			5 st	10 st	15 st		5 st	10 st	15 st	
4	M8 x 1.0	7	16	24	32	3	23.5	31.5	39.5	2
6	M10 x 1.0	9	18.5	25.5	32.5	3	27.5	34.5	41.5	3
10	M15 x 1.5	13	20.5	27	34	4	32.5	39	46	5
15	M22 x 1.5	20	23.5	29.5	36	5	37.5	43.5	50	6

Dimensions: Embedded Type

CJPS4

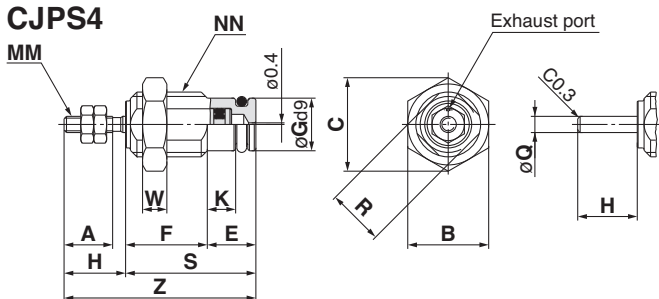

CJPS6, 10, 15

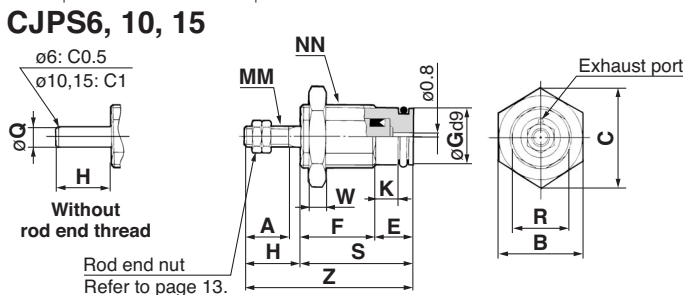

Bore size (mm)	A	B	C	E	F			G	H	K	MM
					5 st	10 st	15 st				
4	6	10	11.5	6	10	18	26	6.5	7.5	3.5	M2
6	7	12	13.9	6	12.5	19.5	26.5	8.5	9	3.5	M3
10	10	19	22	6	14.5	21	28	12	12	3.5	M4
15	12	27	31	7	16.5	22.5	29	19	14	4.2	M5

Bore size (mm)	NN	R	S			W	Z			Q
			5 st	10 st	15 st		5 st	10 st	15 st	
4	M8 x 1.0	7	16	24	32	3	23.5	31.5	39.5	2
6	M10 x 1.0	9	18.5	25.5	32.5	3	27.5	34.5	41.5	3
10	M15 x 1.5	13	20.5	27	34	4	32.5	39	46	5
15	M22 x 1.5	20	23.5	29.5	36	5	37.5	43.5	50	6

⚠ Specific Product Precautions

Be sure to read this before handling. Consult with SMC for the use other than the specifications.

Piping

⚠ Caution

The following fittings are recommended for this cylinder connection. However, there may be a case where the piston speed exceeds 500 mm/sec. even with the recommended fittings for this cylinder. Use a speed controller in such cases.

Cylinder bore size	Applicable bore size	Fitting type	Connection thread	Model
ø4	ø2	One-touch fitting	M3 x 0.5	KQ2□02-M3G
		Miniature fitting		M-3AU-2
One-touch fitting		M5 x 0.8	KQ2□02-M5N	
Miniature fitting			M-5AU-2	
ø6 ø10 ø15	ø4/2.5	Dedicated hose nipple (with fixed orifice)	M5 x 0.8	CJ-5H-4
	ø6/4			CJ-5H-6

* Please be aware that cylinder speed may slow down on the retracting side when using the above one-touch fittings and miniature fittings with a cylinder bore size of ø15.

Hose nipple

CJ-5H-4
(For ø4/ø2.5 tubing)

CJ-5H-6
(For ø6/ø4 tubing)

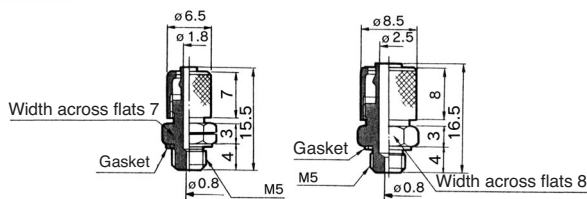

In addition to the above fittings and hose nipples, the below fittings can also be attached to the cylinder. When using the below fittings be sure to provide a speed controller after adjusting it to 500 mm/s or less.

Cylinder bore size	Applicable bore size	Fitting type	Connection thread	Model
ø4	3.2	One-touch fitting	M3 x 0.5	KQ2□23-M3G
	4			KQ2□04-M3G
ø6 ø10 ø15	3.2		M5 x 0.8	KQ2□23-M5□
	4			KQ2□04-M5□
	6			KQ2□06-M5□

Recommended Speed Controller

Applicable bore size	Connection thread	Elbow type meter-in	Universal type meter-in	In-line type meter-in
ø2	M3	AS1211F-M3-02	—	AS1002F-02
	M5	AS1211F-M5E-02A	—	
ø3.2	M3	AS1211F-M3-23	AS1311F-M3-23	AS1002F-23
	M5	AS1211F-M5E-23A	AS1311F-M5E-23A	
ø4	M3	AS1211F-M3-04	AS1311F-M3-04	AS1002F-04
	M5	AS1211F-M5E-04A	AS1311F-M5E-04A	
ø6	M5	AS1211F-M5E-06A	AS1311F-M5E-06A	AS1002F-06

* For details about one-touch fittings, miniature fittings and speed controllers (applicable tubing O.D. ø2 only), refer to the catalogue ES50-25 (B edition or later). Also, for details about speed controllers (applicable tubing O.D. ø3.2 to ø6), refer to SMC's "Best Pneumatics" catalogue.

* Refer to the Fittings and Tubing Precautions (Best Pneumatics No. 7) for how to handle one-touch fittings.

Mounting

⚠ Caution

Do not use the cylinder in such a way that a load could be applied to the piston rod during the retraction.

The spring that is built into the cylinder provides only enough force to retract the piston rod. Thus, if a load is applied, the piston rod will not be able to retract to the end of the stroke.

Series CJP2

Auto Switch Specifications

Auto Switch Common Specifications

Type	Reed switch	Solid state switch
Leakage current	None	3-wire: 100 μ A or less 2-wire: 0.8 mA or less
Operating time	1.2 ms	1 ms or less
Impact resistance	300 m/s ²	1000 m/s ²
Insulation resistance	50 M Ω or more at 500 Mega VDC (between lead wire and case)	
Withstand voltage	1000 VAC for 1 minute (between lead wire and case)	1000 VAC for 1 minute (between lead wire and case)
Ambient temperature	-10 to 60°C	
Enclosure	IEC529 standard IP67, JIS C 0920 waterproof construction	
Standard	Conforming to CE Standards	

Lead Wire Length

Lead wire length indication

(Example) D-M9P **L**

Lead wire length

-	0.5 m
M	1 m
L	3 m
Z	5 m

Note 1) Applicable auto switch with 5 m lead wire "Z"

Solid state switch: Manufactured upon receipt of order as standard.

Note 2) For 1 m(M), available with D-M9□W(V) only.

Contact Protection Boxes: CD-P11, CD-P12

<Applicable switch model>

D-A9/A9□V

The auto switches above do not have a built-in contact protection circuit. Therefore, please use a contact protection box with the switch for any of the following cases:

- ① Where the operation load is an inductive load.
- ② Where the wiring length to load is greater than 5 m.
- ③ Where the load voltage is 100 VAC.

The contact life may be shortened. (Due to permanent energising conditions.)

Specifications

Part no.	CD-P11		CD-P12
Load voltage	100 VAC	200 VAC	24 VDC
Maximum load current	25 mA	12.5 mA	50 mA

* Lead wire length — Switch connection side 0.5 m
Load connection side 0.5 m



Internal Circuit

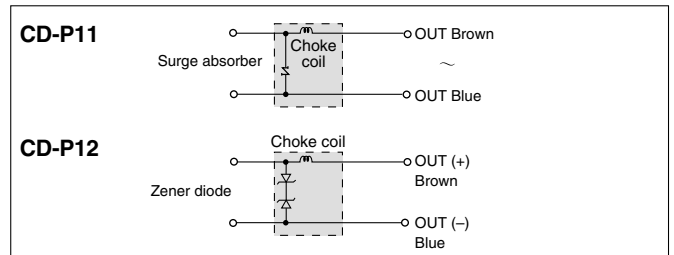

Dimensions

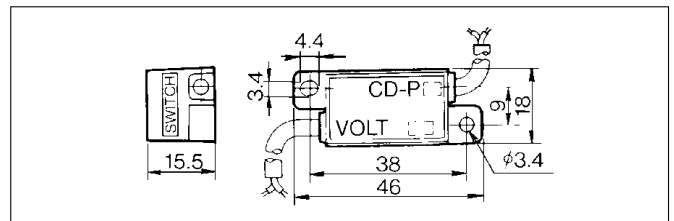

Connection

To connect a switch unit to a contact protection box, connect the lead wire from the side of the contact protection box marked SWITCH to the lead wire coming out of the switch unit. Keep the switch as close as possible to the contact protection box, with a lead wire length of no more than 1 metre.

Auto Switch Connections and Examples

Basic Wiring

Solid state 3-wire, NPN

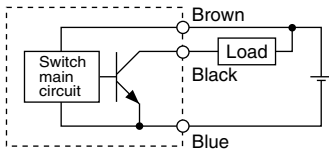

Solid state 3-wire, PNP

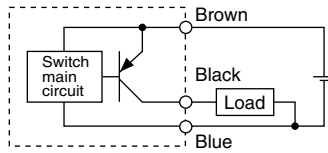

2-wire (Solid state)

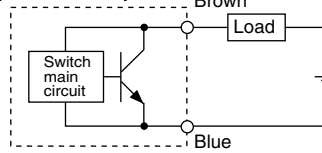

2-wire (Reed)

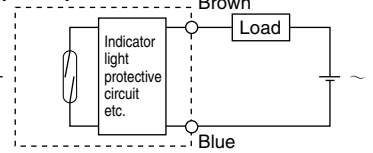

(Power supplies for switch and load are separate.)

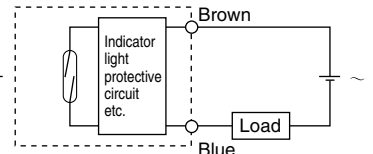
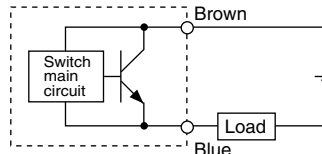
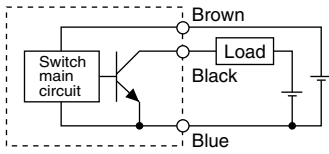

Example of Connection to PLC (Programmable Logic Controller)

• Sink input specification 3-wire, NPN

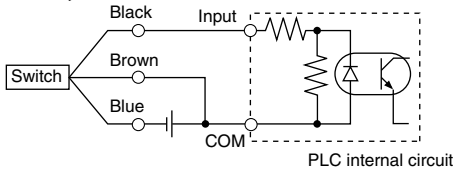

• Source input specification 3-wire, PNP

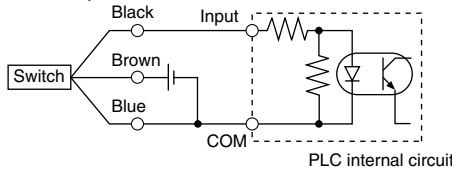

Connect according to the applicable PLC input specifications, since the connection method will vary depending on the PLC input specifications.

2-wire

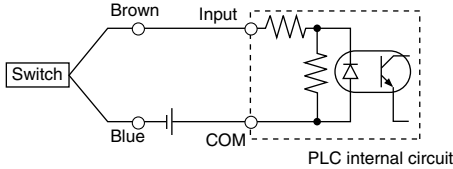

2-wire

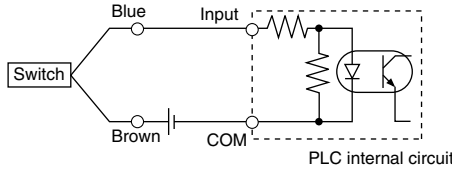

Example of AND (Serial) and OR (Parallel) Connection

• 3-wire

AND connection for NPN output (using relays)

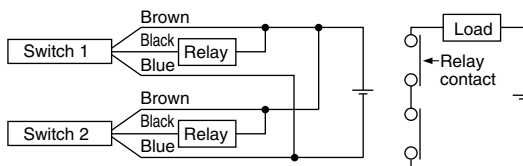

AND connection for NPN output (performed with switches only)

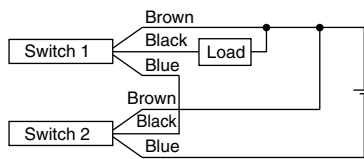

OR connection for NPN output

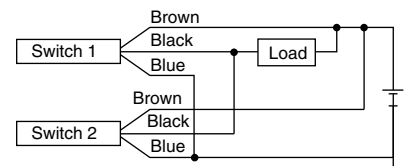

The indicator lights will illuminate when both switches are turned ON.

2-wire with 2-switch AND connection

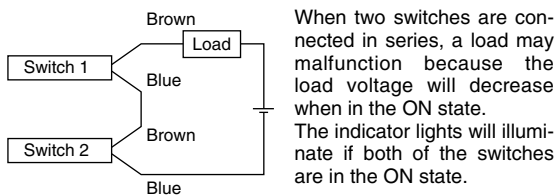

When two switches are connected in series, a load may malfunction because the load voltage will decrease when in the ON state. The indicator lights will illuminate if both of the switches are in the ON state.

$$\begin{aligned} \text{Load voltage at ON} &= \text{Power supply voltage} - \text{Residual voltage} \times 2 \text{ pcs.} \\ &= 24 \text{ V} - 4 \text{ V} \times 2 \text{ pcs.} \\ &= 16 \text{ V} \end{aligned}$$

Example: Power supply is 24 VDC.
Internal voltage drop in switch is 4 V.

2-wire with 2-switch OR connection

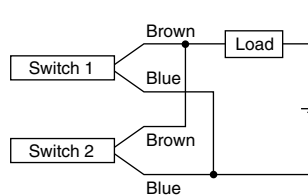

(Solid state)

When two switches are connected in parallel, a malfunction may occur because the load voltage will increase when in the OFF state.

$$\begin{aligned} \text{Load voltage at OFF} &= \text{Leakage current} \times 2 \text{ pcs.} \\ &\quad \times \text{Load impedance} \\ &= 1 \text{ mA} \times 2 \text{ pcs.} \times 3 \text{ k}\Omega \\ &= 6 \text{ V} \end{aligned}$$

Example: Load impedance is 3 kΩ.
Leakage current from switch is 1 mA.

(Reed)

Because there is no current leakage, the load voltage will not increase when turned OFF. However, depending on the number of switches in the ON state, the indicator lights may sometimes dim or not light because of the dispersion and reduction of the current flowing to the switches.

Reed Switch: Direct Mounting Style

D-A90(V)/D-A93(V)/D-A96(V)



For details about certified products conforming to international standards, visit us at www.smcworld.com.

Auto Switch Specifications

PLC: Programmable Logic Controller

Grommet



Caution

Operating Precautions

Fix the switch with the existing screw installed on the switch body. The switch may be damaged if a screw other than the one supplied, is used.

Auto Switch Internal Circuit

D-A90(V)

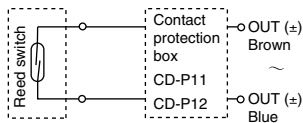

D-A93(V)

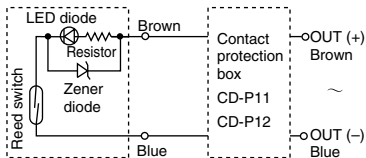

D-A96(V)

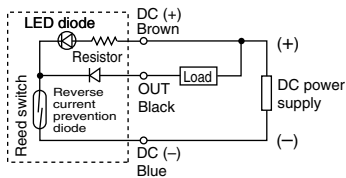

- Note) ① In a case where the operation load is an inductive load.
 ② In a case where the wiring load is greater than 5 m.
 ③ In a case where the load voltage is 100 VAC.

Use the auto switch with a contact protection box in any of the above mentioned cases. (For details about the contact protection box, refer to page 17.)

D-A90/D-A90V (Without indicator light)						
Auto switch part no.	D-A90	D-A90V	D-A90	D-A90V	D-A90	D-A90V
Electrical entry direction	In-line	Perpendicular	In-line	Perpendicular	In-line	Perpendicular
Applicable load	IC circuit, Relay, PLC					
Load voltage	24 VAC/DC or less		48 VAC/DC or less		100 VAC/DC or less	
Maximum load current	50 mA		40 mA		20 mA	
Contact protection circuit	None					
Internal resistance	1 Ω or less (including lead wire length of 3 m)					
D-A93/D-A93V/D-A96/D-A96V (With indicator light)						
Auto switch part no.	D-A93	D-A93V	D-A93	D-A93V	D-A96	D-A96V
Electrical entry direction	In-line	Perpendicular	In-line	Perpendicular	In-line	Perpendicular
Applicable load	Relay, PLC				IC circuit	
Load voltage	24 VDC		100 VAC		4 to 8 VDC	
Load current range and max. load current	5 to 40 mA		5 to 20 mA		20 mA	
Contact protection circuit	None					
Internal voltage drop	D-A93 — 2.4 V or less (to 20 mA)/3 V or less (to 40 mA) D-A93V — 2.7 V or less				0.8 V or less	
Indicator light	Red LED illuminates when ON.					
Standard	Conforming to CE Standards					

Lead wires

D-A90(V)/D-A93(V) — Oilproof heavy-duty vinyl cable: $\phi 2.7$, 0.18 mm² x 2 cores (Brown, Blue), 0.5 m
 D-A96(V) — Oilproof heavy-duty vinyl cable: $\phi 2.7$, 0.15 mm² x 3 cores (Brown, Black, Blue), 0.5 m

Note 1) Refer to page 17 for reed switch common specifications.

Note 2) Refer to page 17 for lead wire lengths.

Weight

Unit: g

Auto switch part no.	D-A90(V)	D-A93(V)	D-A96(V)
Lead wire length 0.5 m	6	6	8
Lead wire length 3 m	30	30	41

Dimensions

Unit: mm

D-A90/D-A93/D-A96

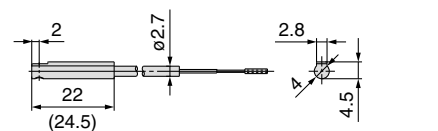
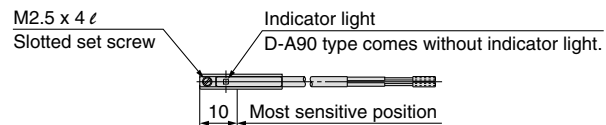

(): dimensions for D-A93.

D-A90V/D-A93V/D-A96V

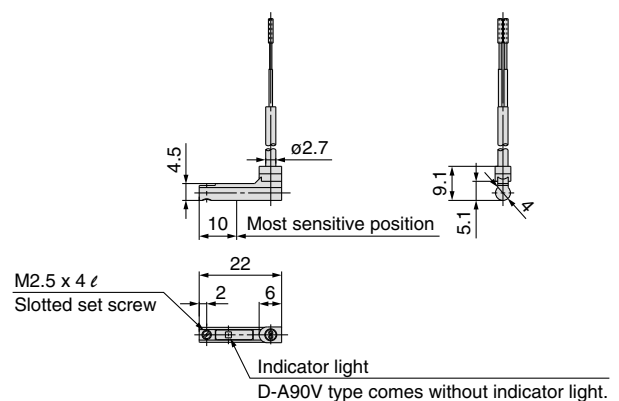

Solid State Switch: Direct Mounting Style D-M9N(V)/D-M9P(V)/D-M9B(V) C €



For details about certified products conforming to international standards, visit us at www.smcworld.com.

Grommet

- 2-wire load current is reduced (2.5 to 40 mA).
- Lead free
- UL certified (style 2844) lead cable is used.
- Flexibility is 1.5 times greater than the conventional model (SMC comparison).
- Using flexible cable as standard spec.

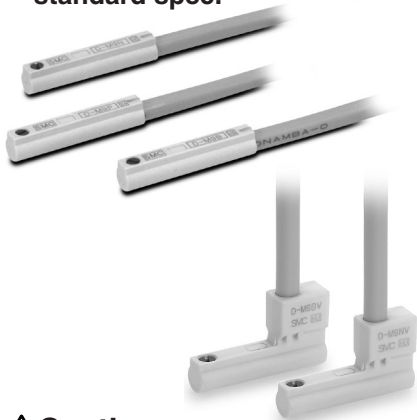

Caution

Operating Precautions

Fix the switch with the existing screw installed on the switch body. The switch may be damaged if a screw other than the one supplied, is used.

Auto Switch Internal Circuit

D-M9N(V)

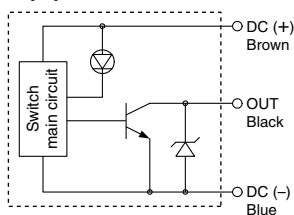

D-M9P(V)

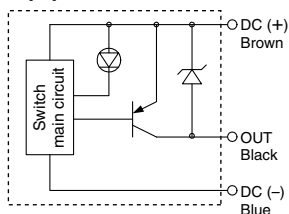

D-M9B(V)

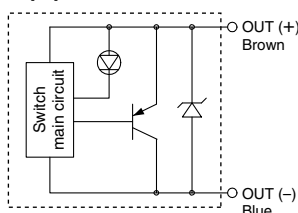

Auto Switch Specifications

PLC: Programmable Logic Controller

D-M9□/D-M9□V (With indicator light)						
Auto switch part no.	D-M9N	D-M9NV	D-M9P	D-M9PV	D-M9B	D-M9BV
Electrical entry direction	In-line	Perpendicular	In-line	Perpendicular	In-line	Perpendicular
Wiring type	3-wire				2-wire	
Output type	NPN		PNP		—	
Applicable load	IC circuit, Relay, PLC				24 VDC relay, PLC	
Power supply voltage	5, 12, 24 VDC (4.5 to 28 V)				—	
Current consumption	10 mA or less				—	
Load voltage	28 VDC or less		—		24 VDC (10 to 28 VDC)	
Load current	40 mA or less				2.5 to 40 mA	
Internal voltage drop	0.8 V or less				4 V or less	
Leakage current	100 μA or less at 24 VDC				0.8 mA or less	
Indicator light	Red LED illuminates when ON.					
Standard	Conforming to CE Standards					

Lead wires

Oilproof heavy-duty vinyl cable: $\phi 2.7 \times 3.2$ ellipse

D-M9B(V) 0.15 mm² x 2 cores

D-M9N(V), D-M9P(V) 0.15 mm² x 3 cores

Note 1) Refer to page 17 for solid state switch common specifications.

Note 2) Refer to page 17 for lead wire lengths.

Weight

Unit: g

Auto switch part no.	D-M9N(V)	D-M9P(V)	D-M9B(V)	
Lead wire length (m)	0.5	8	8	7
	3	41	41	38
	5	68	68	63

Dimensions

Unit: mm

D-M9□

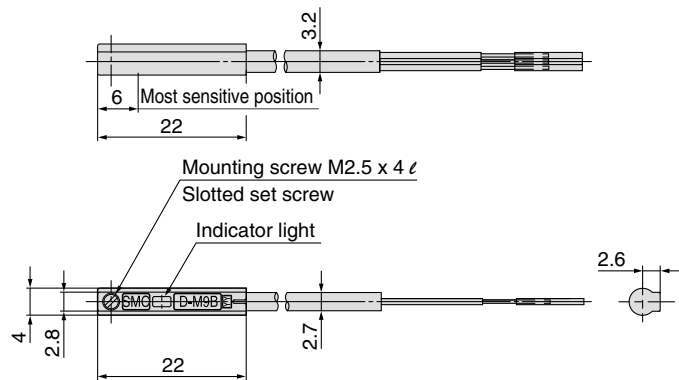

D-M9□V

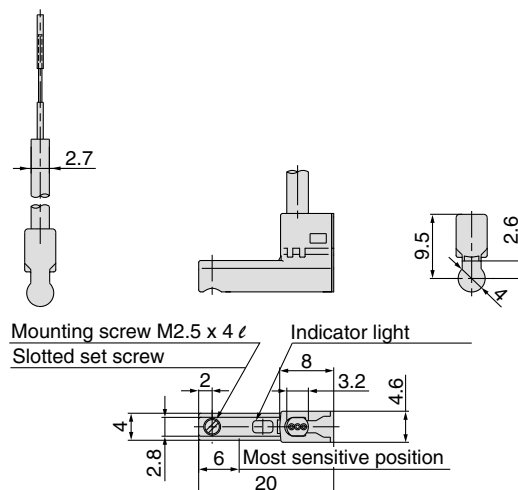

2-Colour Indication Solid State Switch: Direct Mounting Style

D-M9NW(V)/D-M9PW(V)/D-M9BW(V)



For details about certified products conforming to international standards, visit us at www.smcworld.com.

Grommet

- 2-wire load current is reduced (2.5 to 40 mA).
- RoHS compliant
- UL certified (style 2844) lead cable is used.
- Flexibility is 1.5 times greater than the conventional model (SMC comparison).
- Using flexible cable as standard spec.
- The optimum operating position can be determined by the colour of the light. (Red → Green → Red)



Auto Switch Specifications

PLC: Programmable Logic Controller

D-M9□W/D-M9□WV (With indicator light)						
Auto switch part no.	D-M9NW	D-M9NWV	D-M9PW	D-M9PWV	D-M9BW	D-M9BWV
Electrical entry direction	In-line	Perpendicular	In-line	Perpendicular	In-line	Perpendicular
Wiring type	3-wire				2-wire	
Output type	NPN		PNP		—	
Applicable load	IC circuit, Relay IC, PLC				24 VDC relay, PLC	
Power supply voltage	5, 12, 24 VDC (4.5 to 28 VDC)				—	
Current consumption	10 mA or less				—	
Load voltage	28 VDC or less		—		24 VDC (10 to 28 VDC)	
Load current	40 mA or less				2.5 to 40 mA	
Internal voltage drop	0.8 V or less at 10 mA (2 V or less at 40 mA)				4 V or less	
Leakage current	100 μA or less at 24 VDC				0.8 mA or less	
Internal voltage drop	Operating position Red LED illuminates. Optimum operating position Green LED illuminates.					
Standard	Conforming to CE Standards					

● Lead wires

- Oilproof heavy-duty vinyl cable: $\phi 2.7 \times 3.2$ ellipse
- D-M9BW(V) 0.15 mm² x 2 cores
- D-M9NW(V), D-M9PW(V) 0.15 mm² x 3 cores

Note 1) Refer to page 17 for solid state switch common specifications.

Note 2) Refer to page 17 for lead wire lengths.

Auto Switch Internal Circuit

D-M9NW(V)

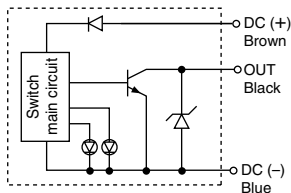

D-M9PW(V)

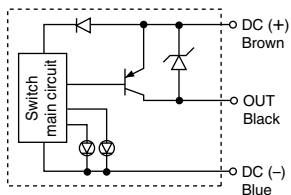

D-M9BW(V)

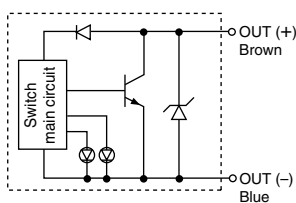

Indicator light / Display method

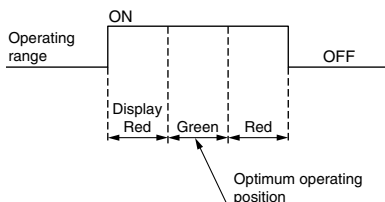

Weight

Unit: g

Auto switch part no.	D-M9NW(V)	D-M9PW(V)	D-M9BW(V)
Lead wire length (m)			
0.5	8	8	7
1	14	14	13
3	41	41	38
5	68	68	63

Dimensions

Unit: mm

D-M9□W

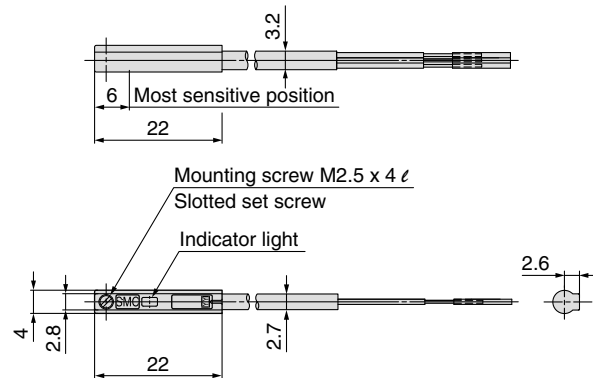

D-M9□WV

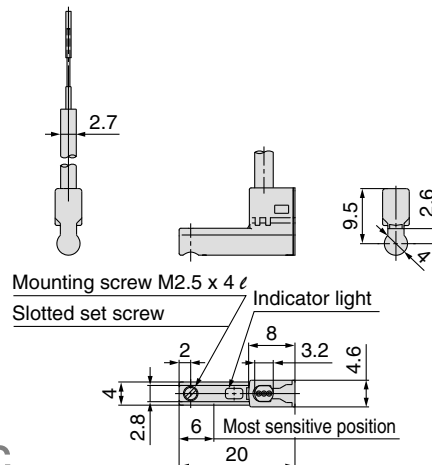

Series CJP2/CJP

Simple Specials: Made to Order



Please contact SMC for detailed specifications, lead times, and prices.

Simple Specials We apply the Simple Made to Order system to the below specials. Contact your SMC representative for details.

Symbol	Description	Double acting, Single rod CJP2	Single acting, Single rod CJP	Bore size	
				CJP2	CJP
1 XA0, 1, 10, 11	Change of rod end shape	●		ø6 to ø16	ø6 to ø15
Made to Order					
1 XB6	Heat resistant cylinder (150°C)	●		ø6 to ø16 ^{Note)}	—
2 XB7	Cold resistant cylinder	●		ø6 to ø16 ^{Note)}	—
3 XC17	Pin cylinder with rod quenched		●	—	ø6 to ø15
4 XC22	Fluoro rubber seals	●	●	ø6 to ø16	ø6 to ø15

Note) Except clevis, trunnion type, with switch.

Simple Specials

1 Change of rod end shape XA0, XA1, XA10, XA11

If a rod-end configuration different from standard is required.

- SMC will make appropriate arrangements if no dimensions, tolerances, or finish instructions are given in the diagram.
- Standard dimensions marked with "*" will be as follows a relation to the rod diameter (D).
 $D \leq 6 \rightarrow D-1 \text{ mm}$ $6 < D \leq 25 \rightarrow D-2 \text{ mm}$ $D > 25 \rightarrow D-4 \text{ mm}$
- In the case of double rod and single acting spring return type, fill in the dimension for when the rod is retracted.

Symbol: **A0**

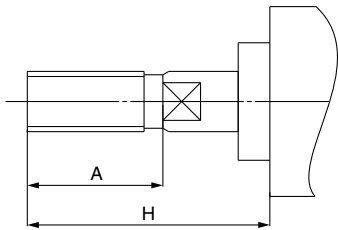

Symbol: **A1**

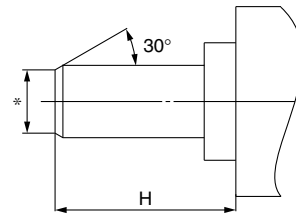

Symbol: **A10**

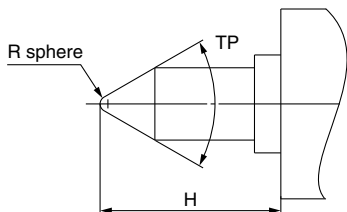

Symbol: **A11**

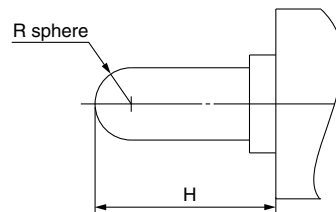

Series CJP2/CJP Made to Order

Please contact SMC for detailed specifications, lead times, and prices.



1 Heat Resistant Cylinder (−10 to 150°C) **Symbol XB6**

An air cylinder in which the seal material and grease are changed, so that it can be used at even higher temperatures up to 150°C from −10°C.

How to Order

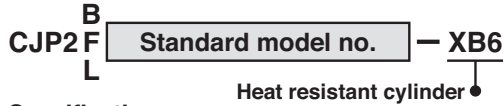

Specifications

Ambient temperature range	−10 to 150°C
Seals material	Fluoro rubber
Grease	Heat resistant grease

Specifications other than above and external dimensions	Same as standard.
---	-------------------

- 🔍 Note 1) Operate without lubrication from a pneumatic system lubricator.
 Note 2) Please contact SMC for details on the maintenance intervals for this cylinder, which differ from those of the standard cylinder.
 Note 3) It is impossible to make built-in magnet type and one with an auto switch.
 Note 4) Piston speed ranged is from 50 to 500 mm/s.

⚠ Warning Precautions

Be aware that smoking cigarettes, etc. after your hands have come into contact with the grease used in this cylinder can create a gas that is hazardous to humans.

2 Cold Resistant Cylinder **Symbol XB7**

An air cylinder in which the seal material and grease are changed, so that it can be used at even lower temperatures down to −40°C.

How to Order

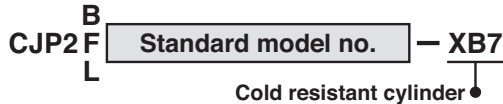

Specifications

Ambient temperature range	−40 to 70°C
Seals material	Low nitrite rubber
Grease	Cold resistant grease
Auto switch	Not mountable
Dimensions	Same as standard.

Additional specifications	Same as standard.
---------------------------	-------------------

- 🔍 Note 1) Operate without lubrication from a pneumatic system lubricator.
 Note 2) Use dry air which is suitable for heatless air dryer, etc. not to cause the moisture to be frozen.
 Note 3) Please contact SMC for details on the maintenance intervals for this cylinder, which differ from those of the standard cylinder.
 Note 4) Mounting an auto switch is impossible.

3 Pin Cylinder with Rod Quenched **Symbol XC17**

The carbon-steel piston rod is induction hardened and chromate surfaced.

How to Order

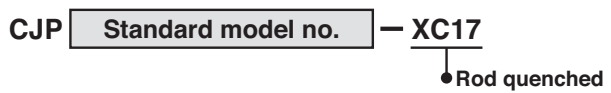

Note) Additional symbol for “-B” (without thread) is unnecessary when indicating the model no.

Specifications: Same as standard.

Construction (Dimensions are the same as standard.)

Panel mount type: CJPB

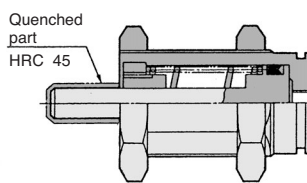

Embedded type: CJPS

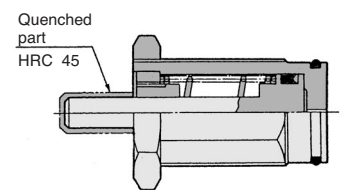

4 Fluoro Rubber Seals **Symbol XC22**

How to Order



Specifications

Seal material	Fluoro rubber
Ambient temperature	With auto switch: −10 to 60°C (No freezing) ^{Note 1)} Without auto switch: −10 to 70°C (No freezing) ^{Note 1)}

Specifications other than above and external dimensions	Same as standard.
---	-------------------

- 🔍 Note 1) Please confirm with SMC, as the type of chemical and the operating temperature may not allow the use of this product.
 Note 2) Cylinders with auto switches can also be produced; however, auto switch related parts (auto switch units, mounting bracket, built-in magnets) are the same as standard products. Before using these, please contact SMC regarding their suitability for the operating environment.





Series CJP2/CJP

Safety Instructions

These safety instructions are intended to prevent a hazardous situation and/or equipment damage. These instructions indicate the level of potential hazard by labels of "**Caution**", "**Warning**" or "**Danger**". To ensure safety, be sure to observe ISO 4414 ^{Note 1)}, JIS B 8370 ^{Note 2)} and other safety practices.

■ Explanation of the Labels

Labels	Explanation of the labels
 Danger	In extreme conditions, there is a possible result of serious injury or loss of life.
 Warning	Operator error could result in serious injury or loss of life.
 Caution	Operator error could result in injury ^{Note 3)} or equipment damage. ^{Note 4)}

Note 1) ISO 4414: Pneumatic fluid power – General rules relating to systems

Note 2) JIS B 8370: General Rules for Pneumatic Equipment

Note 3) Injury indicates light wounds, burns and electrical shocks that do not require hospitalisation or hospital visits for long-term medical treatment.

Note 4) Equipment damage refers to extensive damage to the equipment and surrounding devices.

■ Selection/Handling/Applications

1. The compatibility of the pneumatic equipment is the responsibility of the person who designs the pneumatic system or decides its specifications.

Since the products specified here are used in various operating conditions, their compatibility for the specific pneumatic system must be based on specifications or post analysis and/or tests to meet the specific requirements. The expected performance and safety assurance are the responsibility of the person who has determined the compatibility of the system. This person should continuously review the suitability of all items specified, referring to the latest catalogue information with a view to giving due consideration to any possibility of equipment failure when configuring a system.

2. Only trained personnel should operate pneumatically operated machinery and equipment.

Compressed air can be dangerous if handled incorrectly. Assembly, handling or repair of pneumatic systems should be performed by trained and experienced operators. (Understanding JIS B 8370 General Rules for Pneumatic Equipment, and other safety rules are included.)

3. Do not service machinery/equipment or attempt to remove components until safety is confirmed.

1. Inspection and maintenance of machinery/equipment should only be performed once measures to prevent falling or runaway of the driver objects have been confirmed.
2. When equipment is removed, confirm that safety process as mentioned above. Turn off the supply pressure for this equipment and exhaust all residual compressed air in the system, and release all the energy (liquid pressure, spring, condenser, gravity).
3. Before machinery/equipment is restarted, take measures to prevent quick extension of a cylinder piston rod, etc.

4. Contact SMC if the product will be used in any of the following conditions:

1. Conditions and environments beyond the given specifications, or if product is used outdoors.
2. Installation on equipment in conjunction with atomic energy, railway, air navigation, vehicles, medical equipment, food and beverages, recreation equipment, emergency stop circuits, clutch and brake circuits in press applications, or safety equipment.
3. An application which has the possibility of having negative effects on people, property, requiring special safety analysis.
4. If the products are used in an interlock circuit, prepare a double interlock style circuit with a mechanical protection function for the prevention of a breakdown. And, examine the devices periodically if they function normally or not.

■ Exemption from Liability

1. SMC, its officers and employees shall be exempted from liability for any loss or damage arising out of earthquakes or fire, action by a third person, accidents, customer error with or without intention, product misuse, and any other damages caused by abnormal operating conditions.

2. SMC, its officers and employees shall be exempted from liability for any direct or indirect loss or damage, including consequential loss or damage, loss of profits, or loss of chance, claims, demands, proceedings, costs, expenses, awards, judgments and any other liability whatsoever including legal costs and expenses, which may be suffered or incurred, whether in tort (including negligence), contract, breach of statutory duty, equity or otherwise.

3. SMC is exempted from liability for any damages caused by operations not contained in the catalogues and/or instruction manuals, and operations outside of the specification range.

4. SMC is exempted from liability for any loss or damage whatsoever caused by malfunctions of its products when combined with other devices or software.



Series CJP2 Auto Switches Precautions 1

Be sure to read this before handling.

Design and Selection

⚠ Warning

1. Confirm the specifications.

Read the specifications carefully and use this product appropriately. The product may be damaged or malfunction if it is used outside the range of specifications of current load, voltage, temperature or impact. We do not guarantee any damage in any case the product is used outside of the specification range.

2. Keep wiring as short as possible.

<Reed switch>

As the length of the wiring to a load gets longer, the rush current at switching ON becomes greater, and this may shorten the product's life. (The switch will stay ON all the time.)

Use a contact protection box when the wire length is 5 m or longer.

<Solid state switch>

Although wire length should not affect switch function, use a wire 100 m or shorter.

If the wiring is longer it will likely increase noise although the length is less than 100 m.

When the wire length is long, we recommend attaching the ferrite core to the both ends of the cable to prevent excess noise.

3. Do not use a load that generates surge voltage. If a surge voltage is generated, the discharge occurs at the contact, possibly resulting in the shortening of product life.

<Reed switch>

If driving a load such as a relay that generates a surge voltage, use a contact protection box.

<Solid state switch>

Although a zener diode for surge protection is connected at the output side of a solid state auto switch, damage may still occur if the surge is applied repeatedly. When a load, such as a relay or solenoid, which generates surge is directly driven, use a type of switch with a built-in surge absorbing element.

4. Cautions for use in an interlock circuit

When an auto switch is used for an interlock signal requiring high reliability, devise a double interlock system to avoid trouble by providing a mechanical protection function, or by also using another switch (sensor) together with the auto switch. Also perform periodic maintenance and confirm proper operation.

5. Do not make any modifications to the product.

Do not take the product apart. It may cause human injuries and accidents.

⚠ Caution

1. Take note of the internal voltage drop of the switch.

<Reed switch>

1) Switches with an indicator light (Except D-A96, A96V)

- If auto switches are connected in series as shown below, take note that there will be a large voltage drop because of internal resistance in the light emitting diodes. (Refer to internal voltage drop in the auto switch specifications.)

[The voltage drop will be "n" times larger when "n" auto switches are connected.]

Even though an auto switch operates normally, the load may not operate.



- In the same way, when operating under a specified voltage, although an auto switch may operate normally, the load may not operate. Therefore, the formula below should be satisfied after confirming the minimum operating voltage of the load.

$$\text{Supply voltage} - \text{Internal voltage drop of switch} > \text{Minimum operating voltage of load}$$

2) If the internal resistance of a light emitting diode causes a problem, select a switch without an indicator light (Model D-A90, A90V).

<Solid state switch>

3) Generally, the internal voltage drop will be greater with a 2-wire solid state auto switch than with a reed switch. Take the same precautions as in 1).

Also, note that a 12 VDC relay is not applicable.

2. Pay attention to leakage current.

<Solid state switch>

With a 2-wire solid state auto switch, current (leakage current) flows to the load to operate the internal circuit even when in the OFF state.

$$\text{Operating current of load (OFF condition)} > \text{Leakage current}$$

If the criteria given in the above formula are not met, it will not reset correctly (stays ON). Use a 3-wire switch if this specification will not be satisfied.

Moreover, leakage current flow to the load will be "n" times larger when "n" auto switches are connected in parallel.

3. Ensure sufficient clearance for maintenance activities.

When designing an application, be sure to allow sufficient clearance for maintenance and inspections.

4. Minimum stroke for auto switch mounting

The minimum stroke value for mounting one or two auto switches is obtained when the switch can detect at the cylinder stroke ends.

However, even if the switch is mounted at the proper position within the minimum stroke range, it may not be able to detect when the piston stops in the middle of the stroke due to a stopper, etc. It may also turn on in the middle of a stroke.



Series CJP2 Auto Switches Precautions 2

Be sure to read this before handling.

Design and Selection

Warning

5. Use the cylinder and switch in proper combination.

The auto switch is pre-adjusted to activate properly for an auto-switch-capable SMC cylinder.
If the auto switch is mounted improperly, used for another brand of cylinder or used after the alternation of the machine installation, the switch may not activate properly.

Mounting and Adjustment

Warning

1. Instruction manual

Install the products and operate them only after reading the instruction manual carefully and understanding its contents. Also keep the manual where it can be referred to as necessary.

2. Do not drop or bump.

Do not drop, bump or apply excessive impacts (300 m/s² or more for reed switches and 1000 m/s² or more for solid state switches) while handling. Although the body of the switch may not be damaged, the inside of the switch could be damaged and cause a malfunction.

3. Mount switches using the proper fastening torque.

When a switch is tightened beyond the range of fastening torque, the mounting screws, mounting bracket or switch may be damaged. On the other hand, tightening below the range of fastening torque may allow the switch to slip out of position.

4. Mount a switch at the centre of the operating range.

Adjust the mounting position of an auto switch so that the piston stops at the centre of the operating range (the range in which a switch is ON). (The mounting position shown in a catalogue indicates the optimum position at stroke end.) If mounted at the end of the operating range (around the borderline of ON and OFF), operation will be unstable or the service life will be shortened.

<D-M9□(V)>

When the D-M9□(V) auto switch is used to replace old series auto switch, it may not activate depending on operating condition because of its shorter operating range.

Such as

- Application where the stop position of actuator may vary and exceed the operating range of the auto switch, for example, pushing, pressing, clamping operation, etc.
- Application where the auto switch is used for detecting an intermediate stop position of the actuator. (In this case the detecting time will be reduced.)

In these applications, set the auto switch to the centre of the required detecting range.

Caution

1. Do not carry an actuator by the auto switch lead wires.

Never carry a cylinder (actuator) by its lead wires. This may not only cause broken lead wires, but it may cause internal elements of the switch to be damaged by the stress.

2. Fix the switch with appropriate screw installed on the switch body. If using other screws, switch may be damaged.

Wiring

Warning

1. Confirm proper insulation of wiring.

Be certain that there is no faulty wiring insulation (contact with other circuits, ground fault, improper insulation between terminals, etc.). Damage may occur due to excess current flow into a switch.

2. Do not wire with power lines or high voltage lines.

Wire separately from power lines or high voltage lines, avoiding parallel wiring or wiring in the same conduit with these lines. Control circuits, including auto switches, may malfunction due to noise from these other lines.

Caution

1. Avoid repeatedly bending or stretching lead wires.

It will result in a broken lead wire. Especially when the auto switch is used with a trunnion bracket and bending stress is repeatedly applied to the lead wire, affix the lead wire near the switch to give it an approximate bending radius of more than R40 to R80 mm.

Also, if bending or stretching force is applied to the connection between the lead wire and the switch, the sheath may be peeled or result in a broken lead wire. Be careful not to apply excessive force to the connection.

2. Be sure to connect the load before power is applied.

<2-wire type>

If the power is turned ON when an auto switch is not connected to a load, the switch will be instantly damaged because of excess current.

It is the same as when the 2-wire brown cord (+, output) is directly connected to the (+) power supply terminal.

3. Do not allow short circuit of loads.

<Reed switch>

If the power is turned ON with a load in a short circuited condition, the switch will be instantly damaged because of excess current flow into the switch.

<Solid state switch>

Model D-M9□(V) and all models of PNP output type switches do not have built-in short circuit prevention circuits. If loads are short circuited, the switches will be instantly damaged, as in the case of reed switches.

Take special care to avoid reverse wiring with the power supply line (brown) and the output line (black) on 3-wire type switches.



Series CJP2 Auto Switches Precautions 3

Be sure to read this before handling.

Wiring

⚠ Caution

4. Avoid incorrect wiring.

<Reed switch>

A 24 VDC switch with indicator light has polarity. The brown lead wire is (+) and the blue lead wire is (-).

1) If connections are reversed, a switch will operate, however, the light emitting diode will not light up.

Also note that a current greater than that specified will damage a light emitting diode and it will no longer operate.

Applicable models:

D-A93, D-A93V

<Solid state switch>

1) If connections are reversed on a 2-wire type switch, the switch will not be damaged if protected by a protection circuit, but the switch will always stay in an ON state. However, it is still necessary to avoid reversed connections, since the switch could be damaged by a load short circuit in this condition.

2) If connections are reversed (power supply line + and power supply line -) on a 3-wire type switch, the switch will be protected by a protection circuit. However, if the power supply line (+) is connected to the blue wire and the power supply line (-) is connected to the black wire, the switch will be damaged.

<D-M9□(V)>

D-M9□(V) does not have built-in short circuit protection circuit. Be aware that if the power supply connection is reversed (e.g. (+) power supply wire and (-) power supply wire connection is reversed), the switch will be damaged.

5. When the cable sheath is stripped, confirm the stripping direction. The insulator may be split or damaged depending on the direction. (D-M9□(V) only)

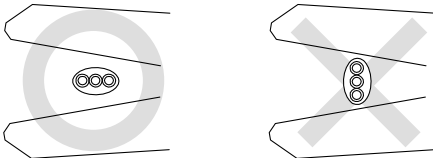

Recommended Tool

Model name	Model no.
Wire stripper	D-M9N-SWY

* Stripper for a round cable (ø2.0) can be used for a 2-wire type cable.

Operating Environment

⚠ Warning

1. Never use in an atmosphere of explosive gases.

The construction of auto switches is not intended to prevent explosion. Never use in an atmosphere with an explosive gas since this may cause a serious explosion.

2. Do not use in an area where a magnetic field is generated.

Auto switches will malfunction or magnets inside actuators will become demagnetised.

3. Do not use in an environment where the auto switch will be in water or continually exposed to water.

Although switches, satisfy IEC standard IP67 construction (JIS C 0920: waterproof construction), do not use switches in applications where continually exposed to water splash or spray. Poor insulation or swelling of the potting resin inside switches may cause malfunction.

4. Do not use in an environment with oil or chemicals.

Consult with SMC if auto switches will be used in an environment with coolant, cleaning solvent, various oils or chemicals. If auto switches are used under these conditions for even a short time, they may be adversely affected by improper insulation, malfunction due to swelling of the potting resin, or hardening of the lead wires.

5. Do not use in an environment with temperature cycles.

Consult with SMC if switches are used where there are temperature cycles other than normal temperature changes, as they may be adversely affected internally.

6. Do not use in an environment where there is excessive impact shock.

<Reed switch>

When excessive impact (300 m/s² or more) is applied to a reed switch during operation, the contact point will malfunction and generate or cut off a signal momentarily (1 ms or less). Consult with SMC regarding the need to use a solid state switch depending upon the environment.

7. Do not use in an area where surges are generated.

<Solid state switch>

When there are units (solenoid type lifter, high frequency induction furnace, motor, radio equipment etc.) which generate large surges or electromagnetic waves in the area around actuators with solid state auto switches, this may cause deterioration or damage to the switches. Avoid sources of surge generation and crossed lines.



Series CJP2 Auto Switches Precautions 4

Be sure to read this before handling.

Operating Environment

Caution

1. Avoid accumulation of iron debris or close contact with magnetic substances.

When a large amount of ferrous debris such as machining chips or spatter is accumulated, or a magnetic substance (something attracted by a magnet) is brought into close proximity with an auto switch actuator, it may cause the auto switch (actuator) to malfunction due to a loss of the magnetic force inside the actuator.

2. Consult with SMC concerning water resistance, elasticity of lead wires, usage at welding sites, etc.

3. Do not use in direct sunlight.

4. Do not mount the product in locations where it is exposed to radiant heat.

Maintenance

Warning

1. Perform the following maintenance periodically in order to prevent possible danger due to unexpected auto switch malfunction.

1) Securely tighten switch mounting screws.

If screws become loose or the mounting position is dislocated, retighten them after readjusting the mounting position.

2) Confirm that there is no damage to lead wires.

To prevent faulty insulation, replace switches or repair lead wires, etc., if damage is discovered.

3) Confirm the lighting of the green light on the 2-colour indicator type switch.

Confirm that the green LED is on when stopped at the established position. If the red LED is on, the mounting position is not appropriate. Readjust the mounting position until the green LED lights up.

2. Maintenance procedures are outlined in the operation manual.

Not following proper procedures could cause the product to malfunction and could lead to damage to the equipment or machine.

3. Removal of equipment, and supply/exhaust of compressed air

Before any machinery or equipment is removed, first ensure that the appropriate measures are in place to prevent the fall or erratic movement of driven objects and equipment, then cut off the electric power and reduce the pressure in the system to zero. Only then should you proceed with the removal of any machinery and equipment.

When machinery is restarted, proceed with caution after confirming that appropriate measures are in place to prevent actuators from sudden movement.



EUROPEAN SUBSIDIARIES:



Austria

SMC Pneumatik GmbH (Austria).
Girakstrasse 8, A-2100 Korneuburg
Phone: +43 2262-62280, Fax: +43 2262-62285
E-mail: office@smc.at
http://www.smc.at



France

SMC Pneumatique, S.A.
1, Boulevard de Strasbourg, Parc Gustave Eiffel
Bussy Saint Georges F-77607 Marne La Vallée Cedex 3
Phone: +33 (0)1-6476 1000, Fax: +33 (0)1-6476 1010
E-mail: contact@smc-france.fr
http://www.smc-france.fr



Netherlands

SMC Pneumatics BV
De Ruyterkade 120, NL-1011 AB Amsterdam
Phone: +31 (0)20-5318888, Fax: +31 (0)20-5318880
E-mail: info@smcpneumatics.nl
http://www.smcpneumatics.nl



Spain

SMC España, S.A.
Zuazobidea 14, 01015 Vitoria
Phone: +34 945-184 100, Fax: +34 945-184 124
E-mail: post@smc.smces.es
http://www.smces.es



Belgium

SMC Pneumatics N.V./S.A.
Nijverheidsstraat 20, B-2160 Wommelgem
Phone: +32 (0)3-355-1464, Fax: +32 (0)3-355-1466
E-mail: post@smcpneumatics.be
http://www.smcpneumatics.be



Germany

SMC Pneumatik GmbH
Boschring 13-15, D-63329 Egelsbach
Phone: +49 (0)6103-4020, Fax: +49 (0)6103-402139
E-mail: info@smc-pneumatik.de
http://www.smc-pneumatik.de



Norway

SMC Pneumatics Norway A/S
Vollsveien 13 C, Granfos Næringspark N-1366 Lysaker
Tel: +47 67 12 90 20, Fax: +47 67 12 90 21
E-mail: post@smc-norge.no
http://www.smc-norge.no



Sweden

SMC Pneumatics Sweden AB
Ekhagsvägen 29-31, S-141 71 Huddinge
Phone: +46 (0)8-603 12 00, Fax: +46 (0)8-603 12 90
E-mail: post@smcpneumatics.se
http://www.smc.nu



Bulgaria

SMC Industrial Automation Bulgaria EOOD
16 klement Ohridski Blvd., fl.13 BG-1756 Sofia
Phone: +359 2 9744492, Fax: +359 2 9744519
E-mail: office@smc.bg
http://www.smc.bg



Greece

SMC Hellas EPE
Anageniseos 7-9 - P.C. 14342, N. Philadelphia, Athens
Phone: +30-210-2717265, Fax: +30-210-2717766
E-mail: sales@smchellas.gr
http://www.smcchellas.gr



Poland

SMC Industrial Automation Polska Sp.z o.o.
ul. Konstruktorska 11A, PL-02-673 Warszawa.
Phone: +48 22 548 5085, Fax: +48 22 548 5087
E-mail: office@smc.pl
http://www.smc.pl



Switzerland

SMC Pneumatik AG
Dorfstrasse 7, CH-8484 Weisslingen
Phone: +41 (0)52-396-3131, Fax: +41 (0)52-396-3191
E-mail: info@smc.ch
http://www.smc.ch



Croatia

SMC Industrijska automatika d.o.o.
Crnomerec 12, 10000 ZAGREB
Phone: +385 1 377 66 74, Fax: +385 1 377 66 74
E-mail: office@smc.hr
http://www.smc.hr



Hungary

SMC Hungary Ipari Automatizálási Kft.
Budafoki út 107-113, H-1117 Budapest
Phone: +36 1 371 1343, Fax: +36 1 371 1344
E-mail: office@smc.hu
http://www.smc.hu



Portugal

SMC Sucursal Portugal, S.A.
Rua de Engº Ferreira Dias 452, 4100-246 Porto
Phone: +351 22-610-89-22, Fax: +351 22-610-89-36
E-mail: postpt@smc.smces.es
http://www.smces.es



Turkey

Entek Pnömatik San. ve Tic Ltd. Sti.
Perpa Tic. Merkezi Kat: 11 No: 1625, TR-80270 Okmeydanı Istanbul
Phone: +90 (0)212-221-1512, Fax: +90 (0)212-221-1519
E-mail: smc-entek@entek.com.tr
http://www.entek.com.tr



Czech Republic

SMC Industrial Automation CZ s.r.o.
Hudcova 78a, CZ-61200 Brno
Phone: +420 5 414 24611, Fax: +420 5 412 18034
E-mail: office@smc.cz
http://www.smc.cz



Ireland

SMC Pneumatics (Ireland) Ltd.
2002 Citywest Business Campus, Naas Road, Saggart, Co. Dublin
Phone: +353 (0)1-403 9000, Fax: +353 (0)1-464-0500
E-mail: sales@smcpneumatics.ie
http://www.smcpneumatics.ie



Romania

SMC Romania srl
Str Frunzei 29, Sector 2, Bucharest
Phone: +40 213205111, Fax: +40 213261489
E-mail: smcromania@smcromania.ro
http://www.smcromania.ro



UK

SMC Pneumatics (UK) Ltd
Vincent Avenue, Crownhill, Milton Keynes, MK8 0AN
Phone: +44 (0)800 1382930 Fax: +44 (0)1908-555064
E-mail: sales@smcpneumatics.co.uk
http://www.smcpneumatics.co.uk



Denmark

SMC Pneumatik A/S
Knudsminde 4B, DK-8300 Odder
Phone: +45 70252900, Fax: +45 70252901
E-mail: smc@smc-pneumatik.dk
http://www.smcdk.com



Italy

SMC Italia S.p.A
Via Garibaldi 62, I-20061Carugate, (Milano)
Phone: +39 (0)2-92711, Fax: +39 (0)2-9271365
E-mail: mailbox@smcitalia.it
http://www.smcitalia.it



Russia

SMC Pneumatik LLC.
4B Sverdlovskaja nab, St. Petersburg 195009
Phone: +812 718 5445, Fax: +812 718 5449
E-mail: info@smc-pneumatik.ru
http://www.smc-pneumatik.ru



Estonia

SMC Pneumatics Estonia OÜ
Laki 12-101, 106 21 Tallinn
Phone: +372 (0)6 593540, Fax: +372 (0)6 593541
E-mail: smc@smcpneumatics.ee
http://www.smcpneumatics.ee



Latvia

SMC Pneumatics Latvia SIA
Smerla 1-705, Riga LV-1006, Latvia
Phone: +371 781-77-00, Fax: +371 781-77-01
E-mail: info@smclv.lv
http://www.smclv.lv



Slovakia

SMC Priemyselna Automatizacia, s.r.o.
Námestie Martina Benku 10, SK-81107 Bratislava
Phone: +421 2 444 56725, Fax: +421 2 444 56028
E-mail: office@smc.sk
http://www.smc.sk



Finland

SMC Pneumatics Finland Oy
PL72, Tiistinniityntie 4, SF-02031 ESPOO
Phone: +358 207 513513, Fax: +358 207 513595
E-mail: smcfi@smc.fi
http://www.smc.fi



Lithuania

SMC Pneumatics Lietuva, UAB
Savanoriu pr. 180, LT-01354 Vilnius, Lithuania
Phone: +370 5 264 81 26, Fax: +370 5 264 81 26



Slovenia

SMC industrijska Avtomatika d.o.o.
Grajski trg 15, SLO-8360 Zuzemberk
Phone: +386 738 85240 Fax: +386 738 85249
E-mail: office@smc.si
http://www.smc.si



OTHER SUBSIDIARIES WORLDWIDE:

ARGENTINA, AUSTRALIA, BOLIVIA, BRASIL, CANADA, CHILE,
CHINA, HONG KONG, INDIA, INDONESIA, MALAYSIA, MEXICO,
NEW ZEALAND, PHILIPPINES, SINGAPORE, SOUTH KOREA,
TAIWAN, THAILAND, USA, VENEZUELA

<http://www.smceu.com>
<http://www.smcworld.com>