

MCX 75 Ohm Right Angle Crimp Type Plug - Captivated Contact

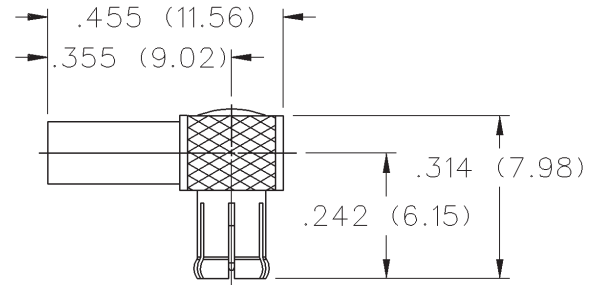

CABLE TYPE	GOLD PLATED
RG-179	133-8433-101

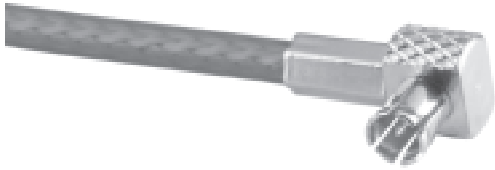
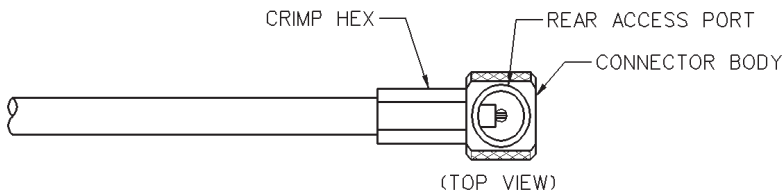
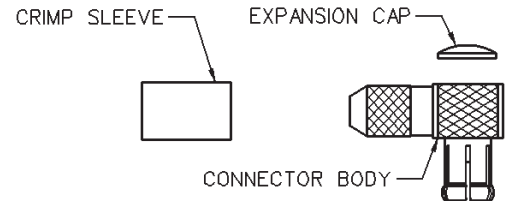
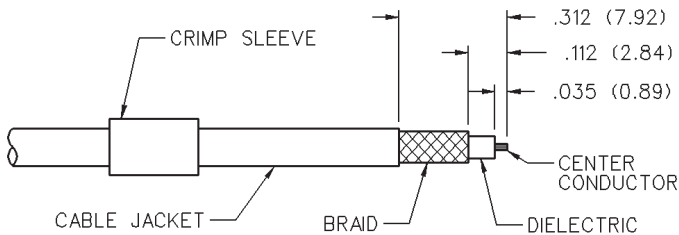

CABLE TYPE	PART NUMBER	CRIMP HEX
RG-179	133-8433-101	.128 (3.25)

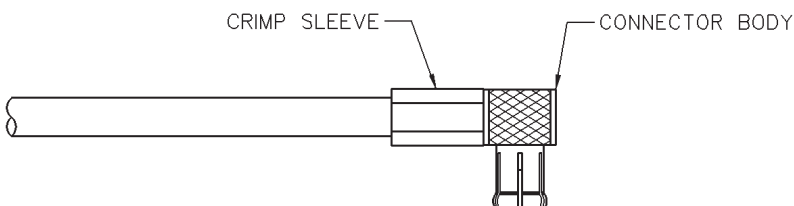
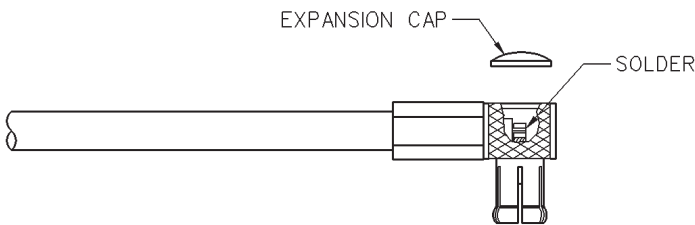

1. Identify connector parts.
2. Strip cable to dimensions shown. Do not nick braid or center conductor. A wire stripper of correct size is recommended for this step. Twist stranded center conductor into tight bundle and tin (optional). Slide crimp sleeve onto cable as shown.
3. Flair braid and slide cable into body making certain that the cable dielectric bottoms on center contact. Arrange braid uniformly around crimp stem. Slide crimp sleeve over braid and crimp securely using recommended crimp tool.
4. Solder center conductor to contact through rear access port. Use a minimum amount of solder for a full fillet joint. **.020 (0.51) diameter solder is recommended.**
5. Place expansion cap in access port and seat with .156 (3.96) diameter flat punch or MCX hand assembly tool 141-0000-908. Shrink heat shrink tubing over crimp sleeve if applicable.

MCX - 75 Ohm Connectors



Specifications

INCHES (MILLIMETERS)
CUSTOMER DRAWINGS AVAILABLE UPON REQUEST

ELECTRICAL RATINGS

Impedance: 75 Ohms
Frequency Range: 0-6 GHz
VSWR: (f = GHz)

	Straight Cabled Connectors	Right Angle Cabled Connectors
RG-179 cable	1.13 + .04f	1.07 + .04f
In-series adapters	1.07 + .03f	
Between series adapters, loads	1.05 + .01f	
Matching pad	1.05 + .05f	
Uncabled receptacles	N/A	

Working Voltage: (Vrms maximum)†

Connectors for Cable Type	Sea Level	70K Feet
RG-179	335	85
Uncabled receptacles, adapters	335	85
Loads, matching pad	N/A	

Dielectric Withstanding Voltage: (VRMS minimum at sea level)

Connectors for RG-179	1000
Uncabled receptacles, adapters	1000
Loads, matching pad	N/A

Corona Level: (Volts minimum at 70,000 feet)†

Connectors for RG-179	250
Uncabled receptacles, adapters	250
Loads, matching pad	N/A

Insertion Loss: (dB maximum, tested at 1 GHz)

Straight cable connectors	0.1 dB
Right angle cable connectors	0.2 dB
Uncabled receptacles, adapters, matching pad	N/A

Insulation Resistance: 10,000 megohms minimum

Contact Resistance: (milliohms maximum)

	Initial	After Environmental
Center contact (straight cabled connectors, uncabled receptacles)	5.0	8.0
Center contact (right angle cabled connectors)	5.0	15.0
Center contact (loads, matching pads)	N/A	
Outer contact	1.0	1.5
Braid to body (gold plated connectors)	1.0	N/A

RF Leakage: (dB typical tested at 2.5 GHz)

Cable connectors	-55 dB typical
Uncabled receptacles, adapters, loads, matching pads	N/A

RF High Potential Withstanding Voltage: (Vrms minimum, tested at 4 and 7 MHz)†

Connectors for RG-179	700
Uncabled receptacles, adapters	600
Loads, matching pad	N/A

Power Rating: (Loads and matching pad only) 1.0 watt at +25°C derated linearly to 0.5 watt at +125°C

MECHANICAL RATINGS

Engagement Design: Compatible with CECC 22220, Series MCX 50 Ohm

Engagement Force: 5.6 pounds maximum axial force

Disengagement Force: 8 pounds maximum axial force, 1 pound min.

Contact Retention: 2.3 pounds min. axial force (captivated contacts)
1 inch-ounce min. torque (uncabled receptacles)

Cable Retention:

	Axial Force* (pounds)	Torque (in-oz)
Connectors for RG-179	20	N/A
Connectors for RG179 DS	25	N/A

*or cable breaking strength whichever is less

ENVIRONMENTAL RATINGS (Meets or exceed the applicable paragraph of MIL-C-39012)

Durability: 500 cycles minimum

Temperature Range: All connectors: - 65°C to + 165°C

Loads and matching pads: - 65°C to + 125°C

Thermal Shock: MIL-STD-202, Method 107, Condition F

Temperature Coefficient: Loads and matching pad: +/- 300ppm/°C

Corrosion: MIL-STD-202, Method 101, Condition B

Shock: MIL-STD-202, Method 213, Condition B

Vibration: MIL-STD-202, Method 204, Condition B

Moisture Resistance: MIL-STD-202, Method 106

MATERIAL SPECIFICATIONS

Bodies: Brass per QQ-B-626, gold plated** per MIL-G-45204 .00001" min. Interface spring - beryllium copper per QQ-C-530, gold plated per MIL-G-45204 .00003" min.

Contacts: Male - brass per QQ-B-626 or beryllium copper per QQ-C-530, gold plated per MIL-G-45204 .00003" min.

Female - beryllium copper per QQ-C-530, gold plated per MIL-G-45204 .00003" min.

Insulators: PTFE fluorocarbon per ASTM D 1710 and ASTM D 1457

Expansion Caps: Brass per QQ-B-613, gold plated per MIL-G-45204 .00001" min.

Crimp Sleeves: Copper per WW-T-799, gold plated per MIL-G-45204 .00001" min.

Mounting Hardware: Brass (nuts) per QQ-B-626 or phosphor bronze (lockwashers) QQ-B-750, gold plated per MIL-G-45204 .00001" min.

†Avoid user injury due to misapplication.

See safety advisory definitions inside front cover.

** All gold plated parts include a .00005" min. nickel underplate barrier layer.

MATING ENGAGEMENT FOR 75 OHM MCX SERIES (INTERMATEABLE WITH CECC 22220 50 OHM MCX)

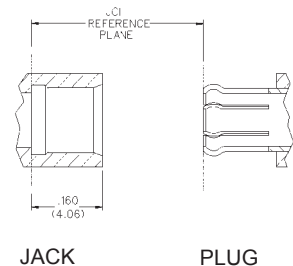
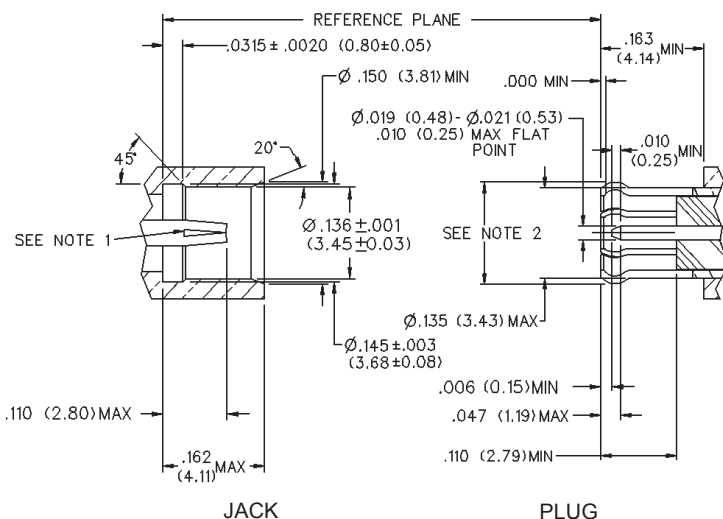

NOTES

- ID of contact to meet VSWR mating characteristics and connector durability when mated with a dia. .019-.021 (0.48-0.53) male contact.
- Must meet the force to engage and disengage when mated with mating part.
- Interface shall intermate with MCX 50 Ohm interface per CECC 22220.

Mouser Electronics

Authorized Distributor

Click to View Pricing, Inventory, Delivery & Lifecycle Information:

[Cinch Connectivity Solutions:](#)

[133-8433-101](#)