

Conductive Elastomer Engineering Handbook

Products and Custom Integrated Solutions

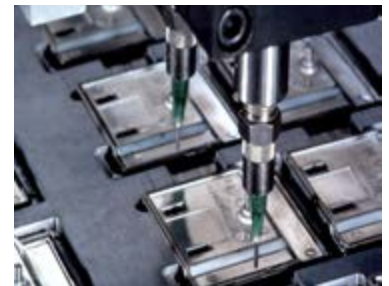

WARNING: The products described in this catalog can expose you to chemicals including Carbon black extracts, Naphthalene, N-methyl Pyrrolidone, Titanium Dioxide, Ethylene Oxide, Ethyl Benzene, Tetrafluoroethylene, Lead, Nickel Compounds, 1,3Butadiene, DiChloromethane, Chloroprene, Di(2-ethylhexyl)phthalate(DEHP), Antimony Oxide, which are known to the State of California to cause cancer, and Methyl Chloride, Lead, 1,3 Butadiene, Toluene, EthyleneOxide, Di(2-ethylhexyl)phthalate(DEHP) which are known to the State of California to cause birth defects or other reproductive harm. For more information go to www.P65Warnings.ca.gov.

Conductive Elastomer Engineering Handbook

Products and Custom Integrated Solutions

CONTENTS

Section 1. Electromagnetic Interference (EMI) Shielding Theory.....	3
Section 2. Corrosion Resistance.....	8
Section 3. Conductive Elastomer Gasket Design Guide.....	16
Section 4. Performance Data	33
Section 5. CHO-SEAL Conductive Elastomer Materials.....	43
Section 6. CHO-SEAL Extrusion Product Guide	52
Section 7. CHO-SEAL Molded Product Guide	74
Section 8. CHOFORM and ParPHorm Form-In-Place (FIP).....	112
Section 9. CHO-MUTE 9005 and 9025 Microwave Absorbers.....	123
Section 10. Integrated EMI Solutions.....	131
Section 11. Parker Chomerics Capabilities.....	142
Section 12. Parker Chomerics Glossary of Terms.....	143
Section 13. Industry Organizations and Standards.....	146
Section 14. Parker Chomerics Sales Terms and Conditions.....	148
Section 15. Parker Chomerics Contact Locations.....	152

SECTION 1

EMI Shielding Theory

Theory of Shielding and Gasketing

Fundamental Concepts

A knowledge of the fundamental concepts of EMI shielding will aid the designer in selecting the gasket inherently best suited to a specific design.

All electromagnetic waves consist of two essential components, a magnetic field, and an electric field. These two fields are perpendicular to each other, and the direction of wave propagation is at right angles to the plane containing these two components. The relative magnitude between the magnetic (H) field and the electric (E) field depends upon how far away the wave is from its source, and on the nature of the generating source itself. The ratio of E to H is called the wave impedance, Z_w .

If the source contains a large current flow compared to its potential, such as may be generated by a loop, a transformer, or power lines, it is called a current, magnetic, or low impedance source. The latter definition is derived from the fact that the ratio of E to H has a small value. Conversely, if the source operates at high voltage, and only a small amount of current flows, the source impedance is said to be high, and the wave is commonly referred to as an electric field. At very large distances from the source, the ratio of E to H is equal for either wave regardless of its origination. When this occurs, the wave is said to be a plane wave, and the wave impedance is equal to 377 ohms, which is the intrinsic impedance of free space. Beyond this point all waves essentially lose their curvature, and the surface containing the two components becomes a plane instead of a section of a sphere in the case of a point source of radiation.

The importance of wave impedance can be illustrated by considering what happens when an electromagnetic wave encounters a discontinuity. If

the magnitude of the wave impedance is greatly different from the intrinsic impedance of the discontinuity, most of the energy will be reflected, and very little will be transmitted across the boundary. Most metals have an intrinsic impedance of only milliohms. For low impedance fields (H dominant), less energy is reflected, and more is absorbed, because the metal is more closely matched to the impedance of the field. This is why it is so difficult to shield against magnetic fields. On the other hand, the wave impedance of electric fields is high, so most of the energy is reflected for this case.

Consider the theoretical case of an incident wave normal to the surface of a metallic structure as illustrated in Figure 1-1. If the conductivity of the metal wall is infinite, an electric field equal and opposite to that of the incident electric field components of the wave is generated in the shield. This satisfies the boundary condition that the total tangential electric field must vanish at the boundary. Under these ideal conditions, shielding should be perfect because the two fields exactly cancel one another. The fact that the magnetic fields are in phase means that the current flow in the shield is doubled.

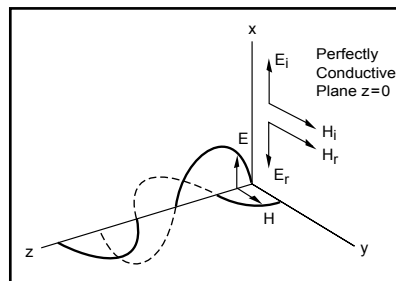

Figure 1-1 Standard Wave Pattern of a Perfect Conductor Illuminated by a Normally Incident, +X Polarized Plane Wave

Shielding effectiveness of metallic enclosures is not infinite, because the conductivity of all metals is finite. They can, however, approach very large values. Because metallic shields have less than infinite conductivity, part of the field is transmitted across the boundary and supports a current in the metal as illustrated in Figure 1-2. The amount of

current flow at any depth in the shield, and the rate of decay is governed by the conductivity of the metal and its permeability. The residual current appearing on the opposite face is the one responsible for generating the field which exists on the other side.

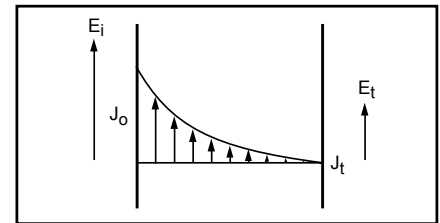

Figure 1-2 Variation of Current Density with Thickness for Electrically Thick Walls

Our conclusion from Figures 1-2 and 1-3 is that thickness plays an important role in shielding. When skin depth is considered, however, it turns out that thickness is only critical at low frequencies. At high frequencies, even metal foils are effective shields.

The current density for thin shields is shown in Figure 1-3. The current density in thick shields is the same as for thin shields. A secondary reflection occurs at the far side of the shield for all thicknesses. The only difference with thin shields is that a large part of the re-reflected wave may appear on the front surface. This wave can add to or subtract from the primary reflected wave depending upon the phase relationship between them. For this reason, a correction factor appears in the shielding calculations to account for reflections from the far surface of a thin shield.

A gap or slot in a shield will allow electromagnetic fields to radiate through the shield, unless the current continuity can be preserved across the gaps. The function of an EMI gasket is to preserve continuity of current flow in the shield.

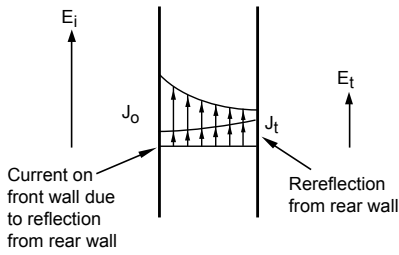

Figure 1-3 Variation of Current Density with Thickness for Electrically Thin Wall

If the gasket is made of a material identical to the walls of the shielded enclosure, the current distribution in the gasket will also be the same assuming it could perfectly fill the slot. (This is not possible due to mechanical considerations.)

The flow of current through a shield including a gasket interface is illustrated in Figure 1-4. Electromagnetic leakage through the seam can occur in two ways. First, the energy can leak through the material directly. The gasket material shown in Figure 1-4 is assumed to have lower conductivity than the material in the shield. The rate of current decay, therefore, is also less in the gasket. It is apparent that more current will appear on the far side of the shield.

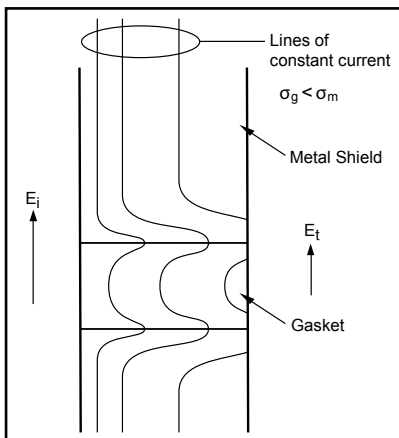

Figure 1-4 Lines of Constant Current Flow Through a Gasketed Seam

This increased flow causes a larger leakage field to appear on the far side of the shield. Second, leakage can occur at the interface between the gasket and the shield.

If an air gap exists in the seam, the flow of current will be diverted to those points or areas which are in contact. A change in the direction of the flow of current alters the current distribution in the shield as well as in the gasket. A high resistance joint does not behave much differently than open seams. It simply alters the distribution of current somewhat. A current distribution for a typical seam is shown in Figure 1-4. Lines of constant current flow spaced at larger intervals indicate less flow of current. It is important in gasket design to make the electrical properties of the gasket as similar to the shield as possible, maintain a high degree of electrical conductivity at the interface, and avoid air, or high resistance gaps.

Shielding and Gasket Equations¹

The previous section was devoted to a physical understanding of the fundamental concepts of shielding and gasketing. This section is devoted to mathematical expressions useful for general design purposes. It is helpful to understand the criteria for selecting the parameters of a shielded enclosure.

In the previous section, it was shown that electromagnetic waves incident upon a discontinuity will be partially reflected, and partly transmitted across the boundary and into the material. The effectiveness of the shield is the sum total of these two effects, plus a correction factor to account for reflections from the back surfaces of the shield. The overall expression for shielding effectiveness is written as:

$$S.E. = R + A + B \tag{1}$$

where
 S.E. is the shielding effectiveness² expressed in dB,
 R is the reflection factor expressed in dB,
 A is the absorption term expressed in dB, and
 B is the correction factor due to reflections from the far boundary expressed in dB.

Table 1-1

The reflection term is largely dependent upon the relative mismatch between the incoming wave and the surface impedance of the shield. Reflection terms for all wave types have been worked out by others.³ The equations for the three principal fields are given by the expressions:

$$R_E = 353.6 + 10 \log_{10} \frac{G}{f^2 \mu r_1^2} \tag{2}$$

$$R_H = 20 \log_{10} \left(\frac{0.462}{r_1} \sqrt{\frac{\mu}{Gf}} + 0.136r_1 \sqrt{\frac{fG}{\mu}} + 0.354 \right) \tag{3}$$

$$R_p = 108.2 + 10 \log_{10} \frac{G \times 10^6}{\mu f} \tag{4}$$

where

R_E , R_H , and R_p are the reflection terms for the electric, magnetic, and plane wave fields expressed in dB.

G is the relative conductivity referred to copper,

f is the frequency in Hz,

μ is the relative permeability referred to free space,

r_1 is the distance from the source to the shield in inches.

Table 1-2

The absorption term A is the same for all three waves and is given by the expression:

$$A = 3.338 \times 10^{-3} \times t \sqrt{\mu f G} \tag{5}$$

where

A is the absorption or penetration loss expressed in dB, and t is the thickness of the shield in mils

Table 1-3

The factor B can be mathematically positive or negative (in practice it is always negative), and becomes insignificant when $A > 6$ dB. It is usually only important when metals are thin, and at low frequencies (i.e., below approximately 20 kHz).

$$B \text{ (in dB)} = 20 \log_{10} \left| 1 - \left(\frac{K-1}{K+1} \right)^2 \right| \left(10^{-A/10} \right) \left(e^{-j.227A} \right) \tag{6}$$

where

A = absorption losses (dB)

$|K| = |Z_s/Z_H| = 1.3(\mu/fr^2G)^{1/2}$

Z_s = shield impedance

Z_H = impedance of the incident magnetic field

Table 1-4

References
 1. Much of the analysis discussed in this section was performed by Robert B. Cowdell, as published in "Nomograms Simplify Calculations of Magnetic Shielding Effectiveness" EDN, page 44, September 1, 1972.
 2. Shielding Effectiveness is used in lieu of absorption because part of the shielding effect is caused by reflection from the shield, and as such is not an absorption type loss.
 3. Vasaka, G.J., Theory, Design and Engineering Evaluation of Radio-Frequency Shielded Rooms, U.S. Naval Development Center, Johnsville, Pa., Report NADC-EL-54129, dated 13 August, 1956

The preceding equation was solved in two parts. A digital computer was programmed to solve for B with a preselected value of A, while $|K|$ varied between 10^4 and 10^3 . The results are plotted in Graph 1-2.

The nomograph shown in Figure 1-7 was designed to solve for $|K|$ in equation (6). Note that when ZH becomes much smaller than ZS ($K > 1$), large positive values of B may result. These produce very large and unrealistic computed values of S.E., and imply a low frequency limitation on the B equation. In practical cases, absorption losses (A) must be calculated before B can be obtained.¹

A plot of reflection and absorption loss for copper and steel is shown in Graph 1-1. This illustration gives a good physical representation of the behavior of the component parts of an electromagnetic wave. It also illustrates why it is so much more difficult to shield magnetic fields than electric fields or plane waves. Note: In Graph 1-1, copper offers more shielding effectiveness than steel in all cases except for absorption loss. This is due to the high permeability of iron.

These shielding numbers are theoretical, hence they are very high (and unrealistic) practical values.

If magnetic shielding is required, particularly at frequencies below 14 kHz, it is customary to neglect all terms in equation (1) except the absorption term A. Measurements of numerous shielded enclosures bears this out. Conversely, if only electric field, or plane wave protection is required, reflection is the important factor to consider in the design.

The effects of junction geometry, contact resistance, applied force and other factors which affect gasket performance are discussed in the design section which follows.

Polarization Effects

Currents induced in a shield flow essentially in the same direction as the electric field component of the inducing wave. For example, if the electric component of a wave is vertical, it is known as a vertically polarized wave, and it will cause

a current to flow in the shield in a vertical direction.

A gasket placed transverse to the flow of current is less effective than one placed parallel to the flow of current.

A circularly polarized wave contains equal vertical and horizontal components, so gaskets must be equally effective in both directions. Where polarization is unknown, gasketed junctions must be designed and tested for the worse condition; that is, where the flow of current is parallel to the gasket seam.

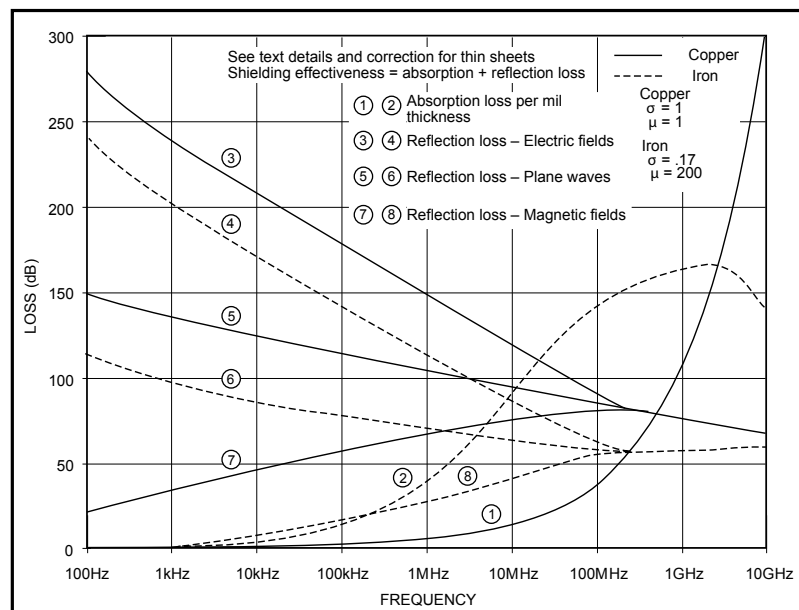

Graph 1-1 Shielding Effectiveness of Metal Barriers

References

1. Robert B. Cowdell, "Nomograms Simplify Calculations of Magnetic Shielding Effectiveness" EDN, page 44, September 1, 1972.

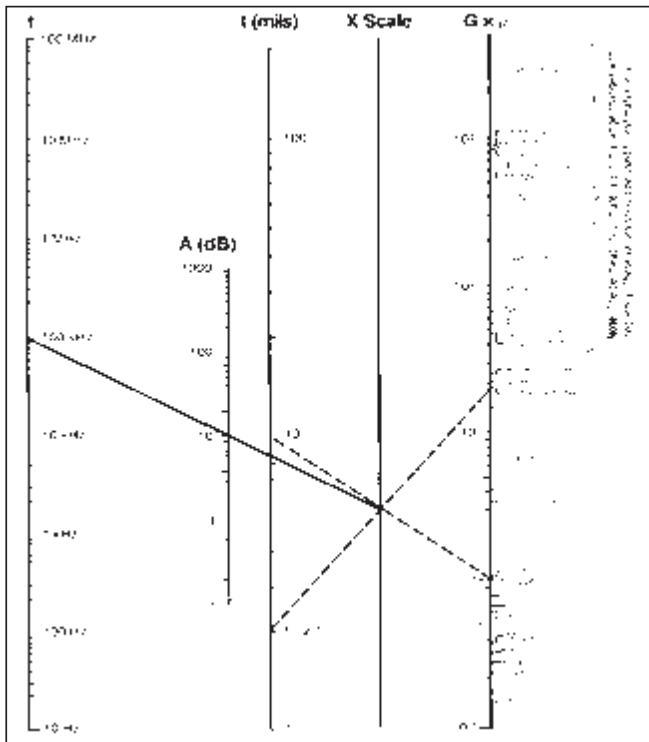

Figure 1-5 Absorption Loss Nomograph¹

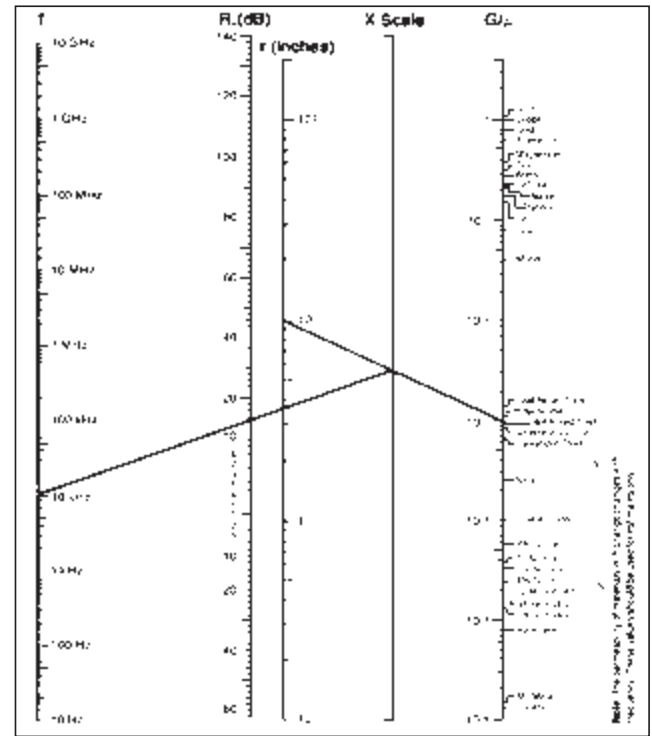

Figure 1-6 Magnetic Field Reflection Loss Nomograph, R_H ¹

Nomographs

The nomographs presented in Figures 1-5 through 1-9 will aid the designer in determining absorption and magnetic field reflection losses directly¹. These nomographs are based on the equations described in the previous section.

Absorption Loss - Figure 1-5:

Given a desired amount of absorption loss at a known frequency, determine the required thickness for a known metal:

- Locate the frequency on the f scale and the desired absorption loss on the A scale.

Place a straight-edge across these points and locate a point on the unmarked X scale (Example: $A = 10$ dB, $f = 100$ kHz).

- Pivot the straight-edge about the point on the unmarked X scale to various metals noted on the $G \times \mu$ scale. A line connecting the $G \times \mu$ scale and the point on the unmarked scale will give the required thickness

on the t scale. (Example: for copper $t = 9.5$ mils, cold rolled steel $t = 2.1$ mils). Some care must be exercised in using these charts for ferrous materials because μ varies with magnetizing force.

Magnetic Field Reflection - Figure 1-6

To determine magnetic field reflection loss R_H :

- Locate a point on the G/μ scale for one of the metals listed. If the metal is not listed, compute G/μ and locate a point on the numerical scale.
- Locate the distance between the energy source and the shield on the r scale.
- Place a straight-edge between r and G/μ and locate a point on the unmarked X scale (Example: $r = 10$ inches for hot rolled steel).
- Place a straight-edge between the point on the X scale and the desired frequency on the f scale.
- Read the reflection loss from the

R_H scale. (For $f = 10$ kHz, $R_H = 13$ dB).

- By sweeping the f scale while holding the point on the X scale, R_H versus frequency can be obtained. (For $f = 1$ kHz, $R_H = 3.5$ dB). (Note that thickness is not a factor in calculating reflection losses.)

References

- Robert B. Cowdell, "Nomograms Simplify Calculations of Magnetic Shielding Effectiveness" EDN, page 44, September 1, 1972.

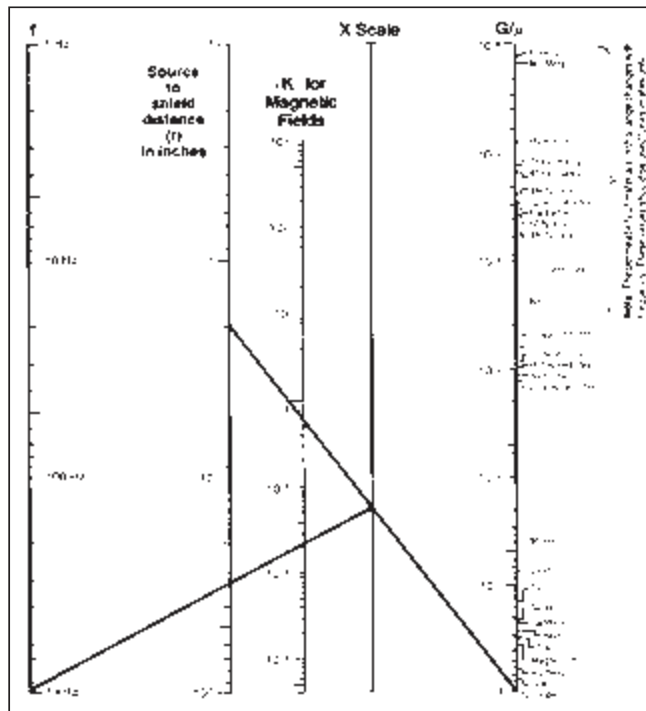
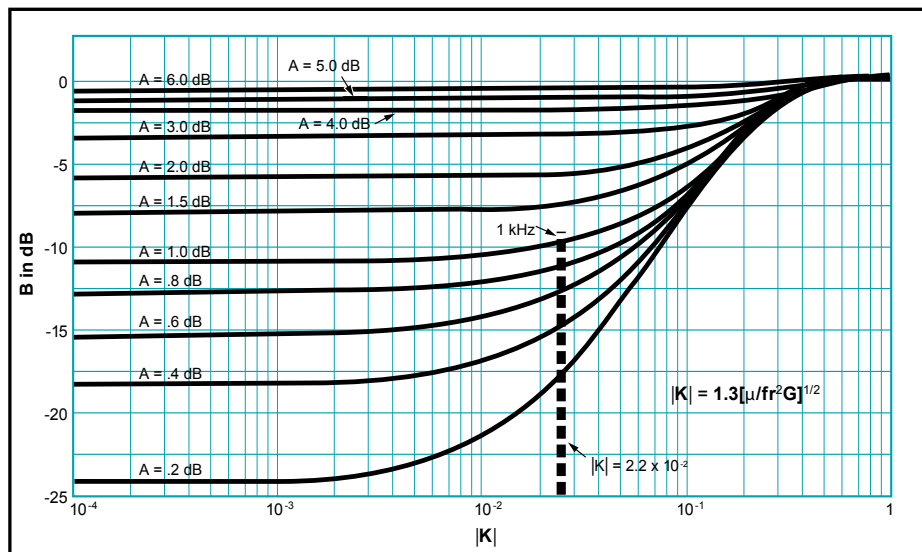

Figure 1-7 Magnetic Field Secondary Reflection loss Factor Nomograph¹



Graph 1-2 Solving for Secondary Reflection loss [B]¹

Magnetic Field Secondary Reflection Losses $|K|$ Figure 1-7 and Graph 1-2:

To determine the magnetic field secondary reflection loss factor $|K|$ to solve for B:

Given: $r = 2$ inches for 0.0162 in. thick copper and $A = 1.3$ dB.
Find B at 1 kHz.

a. Draw a line between copper

on the G/μ scale and $r = 2$ inches on the "source to shield distance scale." Locate a point on the X scale.

b. Draw a line from the point on the X scale to 1 kHz on the f scale.

c. At its intersection with the $|K|$ scale, read $|K| = 2.2 \times 10^{-2}$.

d. Proceed to Graph 1-2.

e. On Figure 1-9, locate $|K| = 2.2 \times 10^{-2}$ on the horizontal scale.

f. Move vertically to intersect the $A = 1.3$ curve (interpolate), and then horizontally to find $B = -8.5$ dB.

References

1. Robert B. Cowdell, "Nomograms Simplify Calculations of Magnetic Shielding Effectiveness" EDN, page 44, September 1, 1972.

SECTION 2

Corrosion Resistance

CORROSION

Corrosion

All metals are subject to corrosion. That is, metal has an innate tendency to react either chemically or electro-chemically with its environment to form a compound which is stable in that environment.

Most electronic packages must be designed for one of four general environments:

Class A. Controlled Environment

Temperature and humidity are controlled. General indoor, habitable exposure.

Class B. Uncontrolled Environment

Temperature and humidity are not controlled. Exposed to humidities of 100 percent with occasional wetting and temperature extremes. Outdoor exposure or exposure in uncontrolled warehouses.

Class C. Marine Environment

Shipboard exposure or land exposure within two miles of salt water where conditions of Class A are not met.

Class D. Space Environment

Exposure to high vacuum and high radiation.

Galvanic Corrosion

The most common corrosion concern related to EMI gaskets is galvanic corrosion. For galvanic corrosion to occur, a unique set of conditions must exist: two metals capable of generating a voltage between them (any two unlike metals will do), electrically joined by a current path, and immersed in a fluid capable of dissolving the less noble of the two (an electrolyte). In summary, the conditions of a battery must exist. When these conditions

Table 2-1: Minimum Finish Requirements

Minimum Finish Requirements for Structural Metals			
Metal	ENVIRONMENT		
	Class A	Class B	Class C
Carbon and Alloy Steel	0.0005 in. zinc plate 0.0003 in. tin	0.0005 in. zinc plate 0.001 in. zinc 0.0005 in. tin	0.003 in. nickel 0.001 in. tin
Corrosion-Resistant Steels	No finish required	No finish required; 0.0005 in. nickel to prevent tarnish	No finish required; 0.001 in. nickel to prevent tarnish
Aluminum 2000 & 7000 series	Chromate conversion coat (MIL-DTL-5541F, Type II, Class 3)	Chromate conversion coat (MIL-DTL-5541F, Type II, Class 3) plus conductive epoxy or urethane	Chromate conversion coat plus conductive epoxy or urethane or non-conductive TopCoat
Aluminum 3000, 5000, 6000 series	No finish required, unless shielding requirements are high (see above)	Chromate conversion coat (MIL-DTL-5541F, Type II, Class 3) plus conductive epoxy or urethane	Chromate conversion coat plus conductive epoxy or urethane or non-conductive TopCoat
Copper and Copper Alloys	0.0003 in. tin	0.0005 in. tin	0.003 in. nickel 0.001 in. tin
Magnesium	0.0003 in. tin	0.0005 in. tin	0.001 in. tin
Zinc Base Castings	No finish required	0.0003 in. tin	0.0005 in. tin

do exist, current will flow and the extent of corrosion which will occur will be directly related to the total amount of current the galvanic cell produces.

When an EMI gasket is placed between two metal flanges, the first condition is generally satisfied because the flanges will probably not be made of the same metal as the gasket (most flanges are aluminum or steel, and most EMI gaskets contain Monel, nickel, aluminum, silver, tin, etc.). The second condition is satisfied by the inherent conductivity of the EMI gasket. The last condition could be realized when the device/system is placed in service. If the environment is salt spray or atmospheric humidity, and this moisture is allowed to collect at the flange/gasket interface, the combination can provide the

electrolyte for the solution of ions.

Many users of EMI gaskets select Monel mesh or Monel wire-filled materials because they are often described as "corrosion-resistant." Actually, they are only corrosion-resistant in the sense that they do not readily oxidize over time, even in the presence of moisture. However, in terms of electrochemical compatibility with aluminum flanges, Monel is extremely active and its use requires extensive edge sealing and flange finish treatment to prevent galvanic corrosion. Most galvanic tables do not include Monel, because it is not a commonly used structural metal. The galvanic table given in MIL-STD-1250 does include Monel, and shows it to have a 0.6 volt potential difference with respect to aluminum – or almost the same as silver.

Finishes

Table 2-1 shows the minimum finish necessary to arrest chemical corrosion and provide an electrically conductive surface for the common metals of construction. Only the Class A, B, and C environments are shown in the table because the space environment is a non-corrosive environment (i.e., metals are not generally affected by the space environment).

Some metals require finishing because they chemically corrode. These are listed in Table 2-1, and should be finished in accordance with the table. To select a proper finish for metals not given in Table 2-1, refer to the material groupings of Table 2-2. Adjacent groups in Table 2-2 are compatible. Another excellent source of information on corrosion-compatible finishes for EMI shielded flanges is ARP 1481, developed and published by SAE's AE-4 Committee (Electromagnetic Compatibility).

When a finish is required to make two mating metals compatible, finish the metal which is found in the lower numbered grouping of Table 2-2.

For example, to couple metals separated by two or more groups (e.g., 4 to 2), find a finish which appears in Group 3 and 4. The Group 3 metal should be plated onto the Group 2 metal to make metals 2 and 4 compatible. The reason for this is, if the finish metal breaks down, or is porous, its area will be large in comparison to the exposed area of the Group 2 metal, and the galvanic corrosion will be less.

On aluminum, chromate conversion coatings (such as Iridite) can be considered as conductive finishes. MIL-DTL-5541, Type II, Class 3 conversion coatings are required to have less than 200 milliohms resistance when measured at 200 psi contact pressure after 168 hours of exposure to a 5 percent salt spray. Suggested MIL-DTL-5541, Type II, Class 3 coatings are SurTec 650 and CHEMEON TCP.

Table 2-2: Metals Compatibility

Metals Compatibility	
Group	Metal Groupings*
1	Gold - Platinum - Gold/Platinum Alloys - Rhodium - Graphite - Palladium - Silver - Silver Alloys - Titanium - Silver Filled Elastomers - Silver Filled Coatings
2	Rhodium - Graphite - Palladium - Silver - Silver Alloys - Titanium - Nickel - Monel - Cobalt - Nickel and Cobalt Alloys - Nickel Copper Alloys - AISI 300 Series Steels - A286 Steel - Silver Filled Elastomers - Silver Filled Coatings
3	Titanium - Nickel - Monel - Cobalt - Nickel and Cobalt Alloys - Nickel Copper Alloys - Copper - Bronze - Brass - Copper Alloys - Silver Solder - Commercial Yellow Brass and Bronze - Leaded Brass and Bronze - Naval Brass - Steels AISI 300 Series, 451, 440, AM 355 and PH hardened - Chromium Plate - Tungsten - Molybdenum - Certain Silver Filled Elastomers
4	Leaded Brass and Bronze - Naval Brass - Steels AISI 431, 440, 410, 416, 420, AM 355 and PH hardened - Chromium Plate - Tungsten - Molybdenum - Tin-Indium - Tin Lead Solder - Lead - Lead Tin Solder - Aluminum 2000 and 7000 Series - Alloy and Carbon Steel - Certain Silver Filled Elastomers - CHO-SHIELD 2000 Series Coatings
5	Chromium Plate - Tungsten - Molybdenum - Steel AISI 410, 416, 420, Alloy and Carbon - Tin - Indium - Tin Lead Solder - Lead - Lead Tin Solder - Aluminum - All Aluminum Alloys - Cadmium - Zinc - Galvanized Steel - Beryllium - Zinc Base Castings
6	Magnesium - Tin

*Each of these groups overlap, making it possible to safely use materials from adjacent groups.

Organic Finishes

Organic finishes have been used with a great deal of success to prevent corrosion. Many organic finishes can be used, but none will be effective unless properly applied. The following procedure has been used with no traces of corrosion after 240 hours of MIL-STD-810 salt fog testing.

Aluminum panels are cleaned with a 20% solution of sodium hydroxide and then chromate conversion coated per MIL-DTL-5541, Type II, Class 3 (immersion process). The conversion coated panels are then coated with a MIL-C-46168 Type 2 urethane coating, except in the areas where electrical contact is required. For additional information, refer to Design Guides for Corrosion Control, page 12.

The finish coat can be any suitable urethane coating that is compatible with the MIL-C-46168 coating. It is important to note that test specimens without the MIL-C-46168 coating will show some signs of corrosion, while coated test specimens will show no traces of corrosion.

Corrosion Proof Flange Design with CHO-SHIELD 2000 Series Coatings

CHO-SHIELD 2001, 2002, and 2003 electrically conductive coatings provide corrosion protection for enclosure flanges which mate with EMI shielding gaskets. They can also provide a corrosion resistant conductive surface coating on aluminum or plastic substrates.

CHO-SHIELD 2000 series coatings are three-part, copper-filled urethanes with filler systems treated to remain electrically stable at elevated temperatures. A number of stabilizers prevent the copper from corroding in high humidity and/or marine environments.

CHO-SHIELD 2001 and 2003 contain soluble chromates to minimize the effects of galvanic corrosion of the aluminum substrate, even in the event of a coating scratch. The CHO-SHIELD 2002 coating, primarily intended for composite substrates or as 2001 repair coating, is chromate-free. They can also provide a corrosion resistant conductive surface coating on aluminum or plastic substrates.

Gasket Selection

In the early 1960s, Chomerics invented CHO-SEAL® 1215, an electrically conductive elastomeric gasket specifically designed to address progressive requirements within the Electromagnetic Interference and Electromagnetic Compatibility (EMI/EMC) marketplace. This revolutionary gasket material, consisting of silver plated copper particles dispersed within a silicone resin system provided a gasket capable of offering both electromagnetic shielding and a degree of environmental protection. In the early 1980s Chomerics changed the market with the development of Cho-Seal 1285, a silver plated aluminum filled silicone material which provided improved environmental protection with increased corrosion resistance. In the early 90's, Chomerics released Cho-Seal 1298, a passivated silver plated aluminum fluorosilicone which again, further advance conductive elastomer technology in the area of environmental protection. Now, with the recent release of the nickel aluminum particle filled series of conductive elastomers, Chomerics has once again revolutionized the conductive elastomer gasket market with the development of CHO-SEAL 6502 and 6503 nickel-aluminum filled conductive elastomers.

The CHO-SEAL nickel-plated aluminum (Ni/Al) filled materials have been proven to simultaneously provide the best corrosion resistance (per CHO-TM101), and the highest degree of shielding effectiveness (Per CHO-TP09/IEEE STD 299) after long term aging tests of any EMI shielding elastomer gasket material. Ni/Al particles have also proven to have a lower transfer impedance (Per CHO-TM-TP10/SAE ARP 1705) than conductive elastomers comprised of other fillers. Chomerics new material types designated as CHO-SEAL 6502 and CHO-SEAL 6503 are Silicone and Fluorosilicone elastomers respectively.

The combination of nickel and aluminum within the filler are inherently stable and have the best galvanic compatibility with chem filmed aluminum flanges which results in optimum durability and stability. Nickel-plated aluminum particle filled elastomers provide the lowest amount of flange pitting

due to galvanic corrosion. CHO-SEAL Ni/Al materials reduce flange pitting on all chromate treated flanges as compared to Ag/Al filled materials by 20 to 50%.

That being said, silver-bearing elastomers can still be a viable solution. A common misconception is that all silver-bearing conductive elastomers behave galvanically as silver. Experiments designed to show the galvanic effects of silver-filled elastomer gaskets on aluminum flanges have shown them to be far less corrosion than predicted. Silver-plated-aluminum filled elastomers exhibit the least traces of galvanic corrosion. (See Table 2-3).

Tables of galvanic potential do not accurately predict the corrosivity of metal-filled conductive elastomers because of the composite nature of these materials. Also, these tables do not measure directly two important aspects of conductive elastomer "corrosion resistance": 1) the corrosion of the mating metal flange and 2) the retention of conductivity by the elastomer after exposure to a corrosive environment which is necessary for EMI shielding and grounding. Instead of using a table of galvanic potentials, the corrosion caused by different conductive elastomers was determined directly by measuring the weight loss of a T6061-T6 grade aluminum coupon in contact with the conductive

elastomer (after exposure to a salt fog environment)

The electrical stability of the elastomer was determined by measuring its volume resistivity per CEPS-0002 before and after exposure. This galvanic corrosion tests were performed in accordance with Chomerics Test Method CHO-TM101.

Table 2-3: Corrosion Potentials for Metals and Gasket Materials

Corrosion Potentials of Various Metals and EMI Gasket Materials (in 5% NaCl at 21°C, after 15 minutes immersion)	
Material	E _{corr} vs. SCE* (Millivolts)
Pure Silver	-25
Silver-filled elastomer	-50
Monel mesh	-125
Silver-plated-copper filled elastomer	-190
Silver-plated-aluminum filled elastomer	-200
Copper	-244
Nickel	-250
Tin-plated Beryllium-copper	-440
Tin-plated copper-clad steel mesh	-440
Aluminum* (1100)	-730
Silver-plated-aluminum filled elastomer (die-cut edge)	-740

*Standard Calamel Electrode. Aluminum Alloys approximately -700 to -840 mV vs. SCE in 3% NaCl. Mansfield, F. and Kenkel, J.V., "Laboratory Studies of Galvanic Corrosion of Aluminum Alloys," Galvanic and Pitting Corrosion - Field and Lab Studies, ASTM STP 576, 1976, pp. 20-47.

Table 2-4a: 168 Hour Typical Elastomers-Galvanic Compatibility Exposure to Salt Spray / Salt Fog

Substrate	Filler				
	Nickel-Plated Aluminum*	Passivated Silver-Plated Aluminum	Silver-Plated Aluminum	Nickel-Plated Graphite	Silver-Plated Copper
Aluminum: 6061-T6 Conversion Coated Type I, Class 3 Finish (Hexavalent)	Excellent	Excellent	Excellent / Good	Fair	Poor
Aluminum: 6061-T6 Conversion Coated Type II, Class 3 Finish (Trivalent)	Excellent	Excellent	Good	Fair	Poor
Aluminum: 6061-T6 Unplated	No Data	Good	Fair	Fair / Poor	Not Recommended
Stainless Steel: 304SS, 316SS	Excellent	Excellent	Excellent	Excellent	No Data
Electroless Nickel .002" thick	Good	Good	Good	Poor	No Data
Magnesium	Not Recommended	Not Recommended	Not Recommended	Not Recommended	Not Recommended

Table 2-4b: 504 Hour Typical Elastomers-Galvanic Compatibility Exposure to Salt Spray / Salt Fog

Aluminum: 6061-T6 Conversion Coated Type I, Class 3 Finish (Hexavalent)	Excellent	Good	Fair	Poor	Not Recommended
Aluminum: 6061-T6 Conversion Coated Type II, Class 3 Finish (Trivalent)	Good	Good	Fair	Poor	Not Recommended

This test method was used to determine, in a quantitative manner, the corrosivity of a conductive elastomer toward a metallic substrate after exposure to a salt fog environment. Chomerics utilizes two test methods for these evaluations - CHO-TM100 and CHO-TM101. The only difference between these test methods is that CHO-TM101 does not include the electrical resistance measurement included in CHO-TM100. The CHO-TM100/101 test fixture shown below illustrates how the conductive elastomer and aluminum coupon are held in contact by compression between two cylindrical Delrin blocks. Compressive force is supplied by a central stainless steel bolt which is environmentally sealed on each end by the use of a non-conductive gasket to prevent fluid from penetrating into the middle of the fixture. Figure 2-1 illustrates the test fixture that was used.

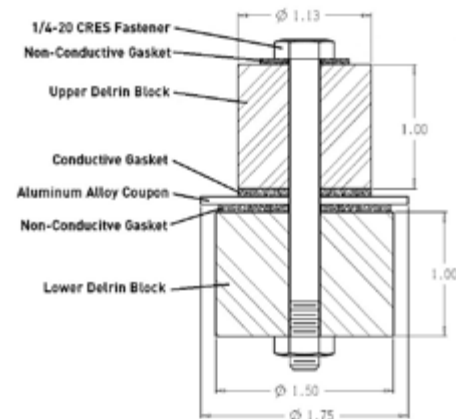

Figure 2-1
Test Fixture

The neutral salt fog exposure for this evaluation was in accordance with ASTM B117 for a duration of 504 hours. After the test samples were disassembled, cleaned and dried according to the test method, they were then evaluated according to the test method.

The corrosivity of the conductive elastomer material is proportional to the weight loss of the aluminum alloy coupon. Weight loss of the coupon is calculated as follows:

$$\text{Weight Loss (mg)} = [\text{Initial Weight (mg)} - \text{Final Weight (mg)}]$$

The gasket materials evaluated were Chomerics CHO-SEAL 6503 nickel-aluminum filled fluorosilicone, CHO-SEAL 6502 nickel-aluminum filled silicone,

CHO-SEAL 1298 passivated silver-

aluminum filled fluorosilicone, CHO-SEAL 6460 nickel-aluminum and nickel-graphite filled EPDM, CHO-SEAL 6452 nickel-graphite filled EPDM, CHO-SEAL 1285 silver-aluminum filled silicone and CHO-SEAL S6305 nickel-graphite filled silicone.

All gasket materials were die cut from molded and/or extruded grades. This shows the worst case scenario as the filler powder is directly exposed and not encapsulated by the elastomer system. It is expected that molded sample disks would perform better due to the fact that the particles are fully encapsulated in the elastomer due to the molding process. Coupons were made of 6061-T6 aluminum and conversion coated to MIL-DTL-5541, Type II, Class 3.

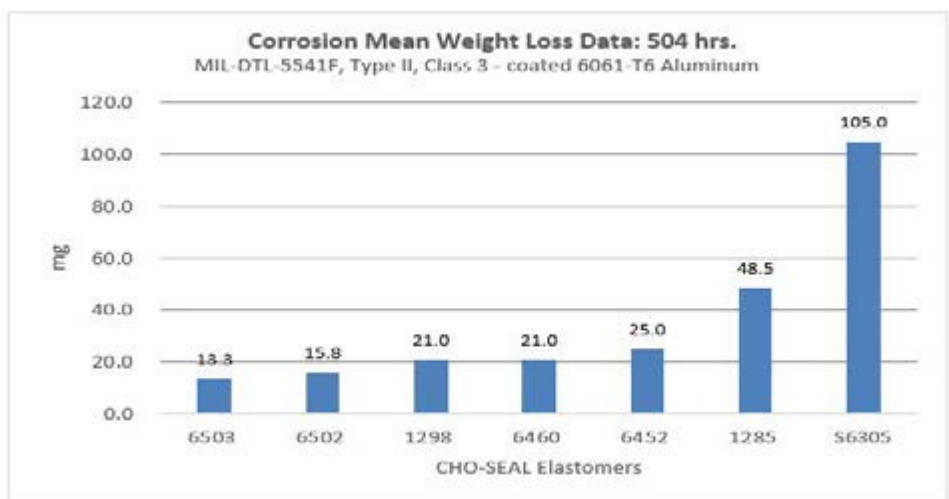

Graph 2-1: Corrosion Coupon Weight

CHO-TM 101



Figure 2-2
Picture of Corrosion Coupon
After 504 hours salt spray / salt fog

Graph 2-1 shows the aluminum weight loss results for a variety of conductive elastomers. The aluminum weight loss shows nearly a magnitude difference between the least corrosive CHO-SEAL 6503 nickel-aluminum filled silicone and most corrosive of the group tested, S6305 nickel-graphite in silicone. For silver-containing elastomers, the filler substrate that the silver is plated on is the single most important factor in determining the overall corrosion caused by the conductive elastomer.

Design Guides for Corrosion Control

The foregoing discussion is not intended to suggest that corrosion should be of no concern when flanges are sealed with nickel-aluminum or silver-bearing conductive elastomers. Rather, corrosion control by and large presents the same problem whether the gasket is nickel-aluminum, silver-filled or Monel wire-filled. Furthermore, the designer must understand the factors which promote galvanic activity and strive to keep them at compatible/safe levels.

By “safe”, it should be recognized that some corrosion is likely to occur (and may be generally tolerable) at the outer (unsealed) edges of a flange after long-term exposure to salt-fog environments. This is especially true if proper attention has not been given to flange materials and finishes. The objective should be control of corrosion within acceptable limits.

The key to corrosion control in flanges sealed with EMI gaskets is proper design of the flange and gasket (and, of course, proper selection of the gasket material). A properly designed interface requires a moisture-sealing gasket whose thickness, shape and compression-deflection characteristics allow it to fill all gaps caused by uneven or unflat flanges, surface irregularities, bowing between fasteners and tolerance buildups. If the gasket is designed and applied correctly, it will exclude moisture and inhibit corrosion on the flange faces and inside the package.

Some specific design suggestions for

proper corrosion control at EMI flanges are:

1. Select nickel-aluminum filled elastomers for best overall sealing and corrosion protection against MIL-DTL-5541, Type II, Class 3 coated aluminum. CHO-SEAL 6502 and 6503 nickel-aluminum materials offer more corrosion resistance than silver-filled elastomers (see Figure 2-2 and Graph 2-1).

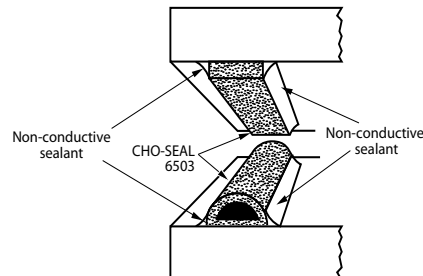

Figure 2-3. “Seal-to-seal” design incorporating CHO-SEAL® 6503 conductive silver-aluminum fluorosilicone gaskets on both mating flange surfaces. Gaskets are bonded and edge sealed to prevent moisture from entering the gasket/flange area.

2. Closely behind the corrosion performance of the nickel-aluminum gaskets described above are silver-

plated-aluminum filled elastomers against MIL-DTL-5541, Type II, Class 3 coated aluminum. CHO-SEAL 1298 material offers more corrosion resistance than any other silver-filled elastomer.

3. For aircraft applications, consider “seal-to-seal” designs, with same gasket material applied to both flange surfaces (see Figure 2-3).

4. To prevent corrosion on outside edges exposed to severe corrosive environments, consider dual conductive/non-conductive gaskets (see Figure 2-4) – or – allow the non-conductive protective paint (normally applied to outside surfaces) to intrude slightly under the gasket mating surface (see Figure 2-5).

DUAL FUNCTIONALITY GASKETS, “Co-Extruded and Co-Molded”

Co-Extruded and Co-Molded gaskets (dual gaskets with both a conductive and a non-conductive element, cured in parallel) provide additional environmental sealing and corrosion protection. Seam vulcanization ensures the long term integrity and stability of the gasket.

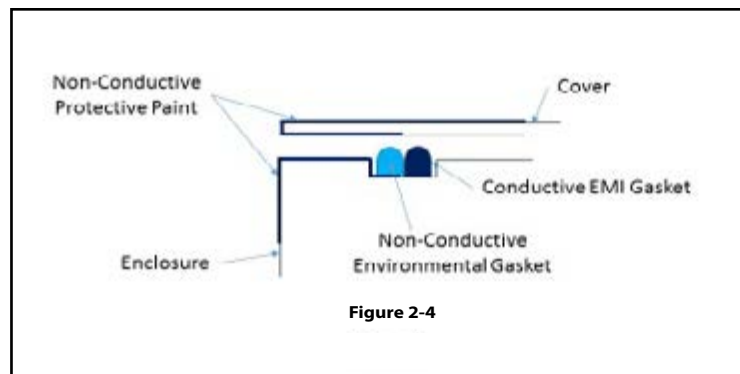

Figure 2-4

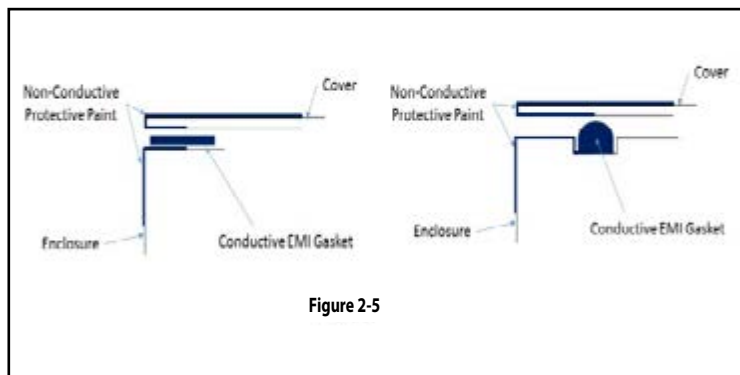

Figure 2-5

Co-Extruded and Co-Molded gaskets permit the use of existing flange designs, while offering attachment alternatives via the less expensive, non-conductive material. Compared to bonding and mounting separate gaskets or double-groove designs, Co-Extruded and Co-Molded gaskets offer design, cost and handling advantages.

5. If moisture is expected to reach the flange interfaces in Class C (marine) environments, flange surfaces should be coated or plated to make them more compatible with the EMI gasket material. Chomerics' CHO-SHIELD 2000 series coatings are recommended for passivated silver-plated aluminum filled elastomer, nickel-plated aluminum filled elastomers or Monel wire gaskets, and tin plating for tin-plated gaskets.

6. Avoid designs which create sump areas for moisture to pool. Provide drainage and/or drain holes for all parts which would become natural sumps.

7. Provide dessicants for parts which will include sumps but cannot be provided with drain holes. Dessicant filters can also be provided for air intake.

8. Avoid sharp edges or protrusions. Dovetail designs, although useful for retaining a gasket, typically damage the conductive gasket due to overfill of the available groove area. A maximum gasket cross sectional area comparison to the minimum groove cross sectional area calculation should be run prior to consideration of a dovetail design.

9. Select proper protective finishes.

The definition of a "safe" level of galvanic activity must clearly be expanded to include the requirements of the design. If all traces of corrosion must be prevented (e.g., airframe applications) the structure must be properly finished or must be made of materials which will not corrode in the use environment. In these cases, the outside edges of EMI-gasket flanges might also require peripheral sealing as defined in MIL-STD-1250, MIL-STD-889 or MIL-STD-454. The MIL-STD-1250 document does deserve special mention. Although the document was developed many years prior to the availability of CHO-SEAL conductive elastomers, it offers the following useful corrosion control methods applicable to electronic enclosures:

A. Bonds made by conductive gaskets or adhesives and involve dissimilar metals/contact, shall be sealed with organic sealant.

B. When conductive gaskets are used, provision shall be made in design for environmental and electromagnetic seal. Where practical, a combination gasket with conductive metal encased in resin or elastomer shall be preferred.

C. Attention is drawn to possible moisture retention when sponge elastomers are used. Materials that "wick" or are hygroscopic (like sponge core mesh gaskets) shall not be used.

D. Because of the serious loss in conductivity caused by corrosion, special precautions such as environmental seals or external sealant beads shall be taken when wire mesh gaskets of Monel or silver are used in conjunction with aluminum or magnesium.

E. Cut or machined edges of laminated, molded, or filled plastics shall be sealed with impervious materials.

F. In addition to suitability for the intended application, nonmetallic materials shall be selected which have the following characteristics:

- a. Low moisture absorption;
- b. Resistance to fungi and microbial attack;
- c. Stability throughout the temperature range;
- d. Freedom from outgassing;
- e. Compatibility with other materials in the assembly;
- f. Resistance to flame and arc;
- g. For outdoor applications, ability to withstand weathering.

Corrosion and Electrical Resistance

A common misconception is that a measurement of DC resistance can predict shielding effectiveness.

Over the years, material science evolution has been proven that EMI gaskets with higher DC resistance can actually produce higher levels of shielding effectiveness in some cases than a gasket with low measured

DC resistance. A DC resistance measurement is also just a resistance value at DC and not over the frequency spectrum typically called for in EMI compliance specifications, such as that required by the FCC and/or MIL-STD-461.

Many factors have an impact on shielding effectiveness of a conductive elastomer EMI gasket and the DC resistance value is only one. Other aspects of EMI gasket and enclosure seam design which effect shielding effectiveness are as follows:

Gasket aspects:

1. Particle morphology – size and shape – ability to bite through conversion coatings
2. Elemental composition of the particle – i.e. permeability, absorption properties
3. Elemental composition of the plating on the particle – i.e. permeability, absorption properties
4. Plating thickness
5. Compounding control and filler loading %
6. EMI gasket surface conductivity and volume resistivity
7. EMI gasket geometry
8. EMI gasket footprint contact size on mating surfaces
9. Gasket deflection %

Enclosure aspects:

- A. Type of metal substrate– aluminum, steel etc.
- B. Conversion coating or plating finish
- C. Fasteners/bolts – quantity, separation, generated gasket compression load
- D. Gasket groove (if used)
- E. Ancillary metal to metal contacts – i.e. hinge etc.

In general, silver-containing elastomers are more electrically stable in a salt fog environment than nickel-containing elastomers. However, as you will see in the following section, DC measurements of volume resistivity do not always predict Shielding Effectiveness levels.

Corrosion and Shielding Effectiveness

When determining what EMI gasket material is best suited for an application one must consider many factors. An EMI gasket producing the best corrosion control may not provide the highest or necessary shielding effectiveness. It has been proven that the best corrosion control EMI gasket may not be necessary in all designs and that electrical conductivity and/or grounding is the primary concern.

Chomerics has developed a new shielding effectiveness (SE) test method known as CHO-TP09 which is based on IEEE-STD-299, the IEEE Standard Test Method for Measuring the Effectiveness of Electromagnetic Shielding Enclosures. The CHO-TP09 test method evaluates an EMI gasket test panel set mounted on the wall of a shielded enclosure. The benefit of CHO-TP09 is that it enables comparative SE testing of gasket panel sets before and after environmental

exposure cycling using a standardized test set-up and procedure.

The CHO-TP09 test plate sets used for this evaluation consist of two 6061-T6 aluminum plates manufactured to the specifications detailed in CHO-TP09 and illustrated on page 40.

All aluminum test plates were surface treated with trivalent (MIL-DTL-5541F, Type II, Class 3) chromate conversion coatings. Incorporating the conversion coating best represents how the gaskets are typically used in final applications.

In addition to the test plates, non-conductive Lexan shims were used as compression stops to target a nominal EMI gasket deflection of 13.1%. The shim, illustrated in Figure 4-9 on page 40 (4 pieces), is designed to fit the bolt pattern on the plate sets and prevent uneven gasket deflection in regions adjacent to the bolts.

The assembled “test sets” were cycled through multiple accelerated environmental aging scenarios including: 125°C +/- 1°C static dry heat; 85°C +/- 1°C and 85% RH +/- 5% RH static heat and humidity; and static neutral (ASTM B117) 5% salt fog (35°C +/- 1°C). The test sets were taken out

of the environmental chambers and measured for shielding effectiveness at intervals of 500, 1000 and 2000 hours.

Illustrated below is the initial shielding effectiveness test data of the nickel-aluminum filled silicone as well as the SE measured for the test sets exposed to Dry Heat, Heat and Humidity and Salt Fog.

The test data included shown below in Graph 2-2 illustrates that CHO-SEAL 6503 Ni/Al filled materials are superior in shielding effectiveness before and after environmental exposure compared to the CHO-SEAL 1298 passivated Ag/Al filled elastomer in Graph 2-3. This supports the contention that higher DC resistance can still produce higher shielding effectiveness. Even after 500 hours of salt fog exposure the nickel-aluminum filled elastomers maintain a shielding effectiveness > 63dB for this test method. The shielding effectiveness test results maintain > 80dB after temperature and temperature/humidity exposure of 1000 and 2000 hours respectively.

CORROSION

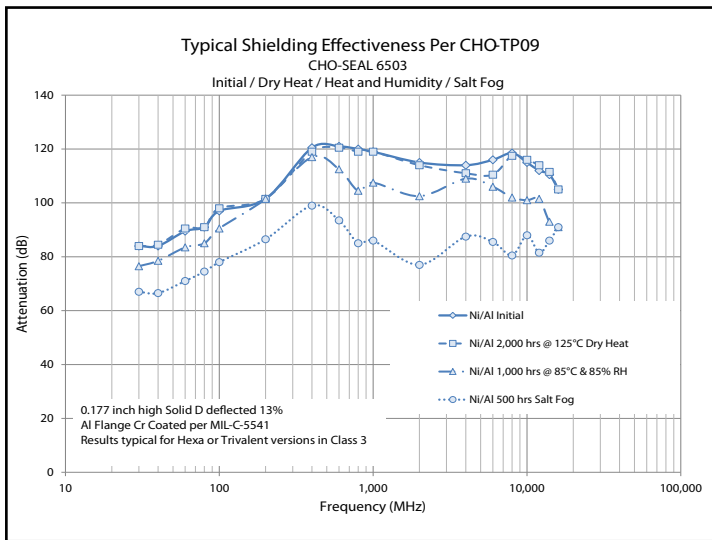

Graph 2-2

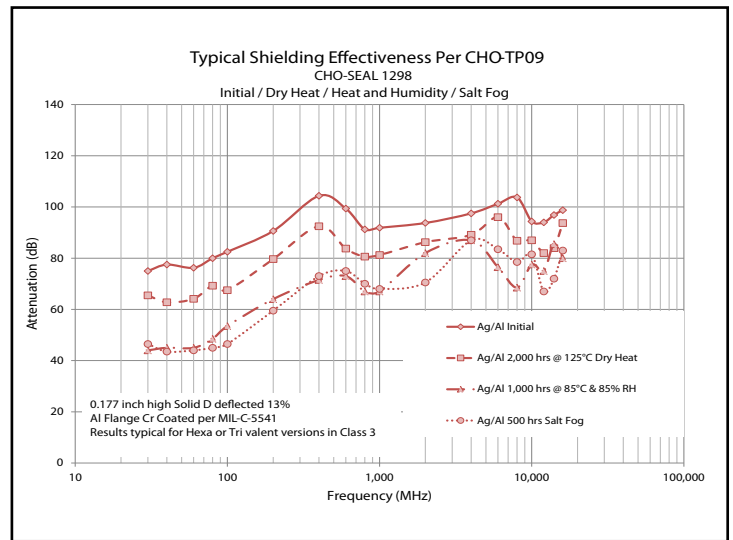

Graph 2-3

Reference Parker Chomerics' Test Report:
2009_11_17-SR 5510.09_TR-1043-EN-November-2009

The reader should take note that this evaluation was set up to create a harsh exposure evaluation in a corrosive environment – NOT – an evaluation to maximize shielding effectiveness. Following recommended EMI gasket design guidelines for corrosive environments will produce significantly greater shielding effectiveness test results. See section on Design Guides for Corrosion Control above.

Inclusion of test data for all materials within this catalog is not practical, nor necessary to support this conclusion. The shielding effectiveness curves shown herein are a composite of results taken over several months of testing on a variety of gasket materials, flange treatments and environmental exposure conditions. This information, and further specifics on the test data/methods can be found in the Test Reports found online at www.parker.com/chomerics

Choosing the right EMI conductive gasket requires knowledge of both electrical and mechanical requirements. Shear forces, environmental effects, compression set, method of application and pricing are just some of the factors influencing choice of gasket which is best for a particular application. Materials must be both cost-effective as well as ensuring equipment and system compliance with Military and Commercial EMI/EMC test requirements and environmental test requirements. In order to help ensure a successful equipment and/or system test cycle why not start by designing in the best gasket available to help get you there – Chomerics CHO-SEAL 6502/6503.

Fluid Resistance

Table 2-5 below illustrate the change in physical properties of CHO-SEAL S6305 (nickel-graphite filled silicone) after exposure to a variety of common

household fluids.

Table 2-6 lists a qualitative assessment of temperature and harsh fluid resistance by unfilled elastomer type. It's important to note that these are typical properties of an unfilled elastomer. In all cases, the customer is encouraged to evaluate specific CHO-SEAL materials to the requirements demanded by the application.

Table 2-5: Gasket Materials Exposure to Common Fluids.

Exposure of CHO-SEAL® S6305 to Common Household Fluids Tensile/Elongation in accordance with ASTM D412				
Exposure Conditions: 70 hours @ 22°C/50% RH		Pre-Exposure	Post-Exposure	% Change
ClearVue®	Tensile [psi]	200	178	-11%
	Elongation [%]	289	317	10%
Formula 409®	Tensile [psi]	200	197	-2%
	Elongation [%]	289	219	-24%
Windex®	Tensile [psi]	200	202	1%
	Elongation [%]	289	166	-43%
Carpet Cleaner	Tensile [psi]	203	207	2%
	Elongation [%]	414	443	7%
Coffee	Tensile [psi]	203	211	4%
	Elongation [%]	414	439	6%
Cola	Tensile [psi]	203	199	-2%
	Elongation [%]	414	433	5%
Hairspray	Tensile [psi]	203	207	2%
	Elongation [%]	414	326	-21%
Tire Cleaner	Tensile [psi]	203	175	-14%
	Elongation [%]	414	418	1%
Vinyl Protectant	Tensile [psi]	203	172	-15%
	Elongation [%]	414	433	5%
Tap Water	Tensile [psi]	203	199	-2%
	Elongation [%]	414	439	6%
Windshield Washer Solvent	Tensile [psi]	203	207	2%
	Elongation [%]	414	418	1%

Table 2-6: Gasket Material Exposure to Temperature and Harsh Fluids.

Typical Elastomer Fluid Resistance			
Exposure/Fluid	Elastomer Choice		
	Silicone	Fluorosilicone	EPDM
High Temp	Excellent	Good	Fair
Low Temp	Excellent	Excellent	Excellent
ASTM 1 Oil	Fair/Good	Good	Poor
Hydraulic Fluids (Phosphate Ester)	Poor	Poor	Good
Hydrocarbon Fuels	Poor	Good	Poor
Ozone, Weather	Good	Good	Good
STB (NBC Decontamination Fluid)	Poor	Fair/Good	Good
Dilute Acids	Fair	Good	Good

SECTION 3

Conductive Elastomer Gasket Design

Gasket Junction Design

The ideal gasketing surface is rigid and recessed to completely house the gasket. Moreover it should be as conductive as possible. Metal surfaces mating with the gasket ideally should be non-corrosive. Where reaction with the environment is inevitable, the reaction products should be electrically conductive or easily penetrable by mechanical abrasion. It is here that many gasket designs fail. The designer could not, or did not treat the mating surface with the same care as that given to the selection of the gasketing material.

By definition, a gasket is necessary only where an imperfect surface exists. If the junction were perfect, which includes either a solidly welded closure, or one with mating surfaces infinitely stiff, perfectly flat, or with infinite conductivity across the junction, no gasket would be necessary. The more imperfect the mating surfaces, the more critical the function of the gasket. Perfect surfaces are expensive. The final solution is generally a compromise between economics and performance, but it should not be at the expense of neglecting the design of the flange surfaces.

The important property that makes a conductive elastomer gasket a good EMI/EMP seal is its ability to provide good electrical conductivity across the gasket-flange interface. Generally, the better the conformability and conductivity, the higher the shielding effectiveness of the gasket. In practice, it has been found that surface conductivity of both the gasket and the mating surfaces is the single most important property that makes the gasketed seam effective; i.e., the resistance between the flange and gasket should be as low as possible.

At this stage of the design every effort should be given to choosing a

flange that will be as stiff as possible consistent with the construction used and within the other design constraints.

1. Flange Materials

Flanges are generally made of the same material as the basic enclosure for reasons of economy, weldability, strength and resistance to corrosion. Wherever possible, the flanges should be made of materials with the highest possible conductivity. It is advisable to add caution notes on drawings not to paint the flange mating surfaces. If paint is to be applied to outside surfaces, be sure that the contact surfaces are well masked before paint is applied, and then cleaned after the masking tape is removed. If the assembled units are subject to painting or repainting in the field, add a cautionary note in a conspicuous location adjacent to the seal that the seal areas are to be masked before painting.

Ordinarily, the higher the conductivity of a material, the more readily it oxidizes – except for noble metals such as gold and silver. Gold is impervious to oxidation, and silver, although it oxidizes, forms oxides that are soft and relatively conductive.

Most oxides, however, are hard. Some of the oxide layers remain thin while others build up to substantial thickness in relatively short time. These oxides form insulating, or semi-conducting films at the boundary between the gasket and the flanges. This effect can be overcome to a degree by using materials that do not oxidize readily, or by coating the surface with a conductive material that is less subject to oxidation. Nickel plating is generally recommended for aluminum parts, although tin has become widely accepted. Zinc is primarily used with steel. Consult the applicable specifications before selecting a finish. A good guide to finishing EMI shielded flanges for

aerospace applications has been published by SAE Committee AE-4 (Electromagnetic Compatibility) under the designation ARP 1481. A discussion of corrosion control follows later in this guide.

2. Advantages of Grooved Designs

All elastomer materials are subject to “Compression Set,” especially if over compressed. Because flange surfaces cannot be held uniformly flat when the bolts are tightened (unless the flanges are infinitely stiff), gaskets tend to overcompress in the areas of the bolts. Proper groove design is required to avoid this problem of over compression. A groove also provides metal-to-metal contact between the flange members, thereby reducing contact resistance across the junction.

A single groove will suffice for most designs. Adding a second groove parallel to the first adds approximately 6 dB to the overall performance of a single-groove design. Adding more grooves beyond the second does not increase the gasketing effectiveness significantly.

3. Flange Design Considerations

Most designers fight a space limitation, particularly in the vicinity of the gasketed seam. Complex fasteners are often required to make the junctions more compact.

The ideal flange includes a groove for limiting the deflection of a gasket. The screw or bolt fasteners are mounted outboard of the gasket to eliminate the need for providing gaskets under the fasteners. A machined flange and its recommended groove dimensions are shown in Figure 3-1. The gasket may be an “O” or “D”-shaped gasket, either solid or hollow.

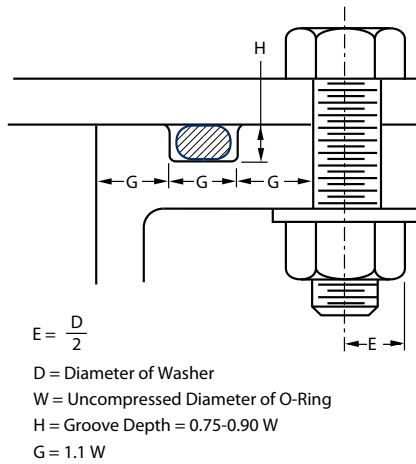

Figure 3-1. Machined Flange with Gasket Groove

Solid conductive O-rings are normally limited to a deflection of 25 percent, see Table 3-1. Therefore, the minimum compressed height of the O-ring (also the groove depth) is related to the uncompressed height (or diameter) by the expression $H = 0.75 W$, where W is the uncompressed diameter. The width of the groove, G , should be equal to $1.1 W$. Allow sufficient void in the groove area to provide for a maximum gasket fill of 97 percent. Conductive elastomer gaskets may be thought of as “incompressible fluids.” For this reason, sufficient groove cross sectional area must be allowed for the largest cross-sectional area of the gasket when tolerances are taken into account. Never allow groove and gasket tolerance accumulations to cause an “over-filled” groove (see gasket tolerances in section which follows).

When a seal is used to isolate pressure environments in addition to EMI, the bottom of the gasket groove should have a surface finish of 32-64 $\mu\text{in.}$ (RMS) to minimize leakage along the grooves. Avoid machining methods that produce longitudinal (circumferential) scratches or chatter marks. Conversely, a surface that is too smooth can cause the gasket to “roll over” or twist in its groove.

The minimum distance from the edge

of the groove to the nearest terminal edge, whether this terminal be the edge of a casting, a change in cross section, or a fastening device, should be equal to the groove width, G .

Bolts should be located a minimum distance, E (equal to one-half the diameter of the washer used under the head of the bolt) from the edge of the flange.

Square or rectangular cross section gaskets can be used in the same groove provided sufficient void is allowed for displacement of the elastomer. A good design practice is not to allow the height of the gasket to exceed the base width. A better, or a more optimum ratio is a height-to-width ratio of one-half. Tall gaskets tend to roll over when loaded.

The thickness of a flange is governed by the stiffness required to prevent excessive bowing between fastener points. Fewer, but larger bolts, require a thicker flange to prevent excessive deflections. For calculations of elastic deformation, refer to pages 21-26.

O-shaped and D-shaped gaskets may also be used in sheet metal flanges. The gaskets can be retained in a U-channel or Z-retainer, and are deflection-limited by adjusting the channel or retainer dimensions with

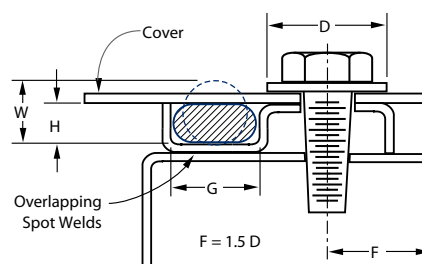

Figure 3-2. Shaped Sheet Metal Container

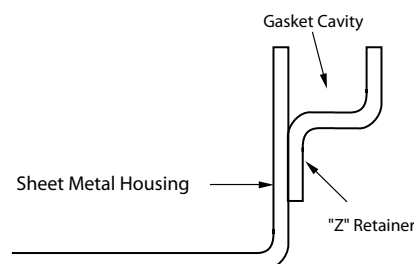

Figure 3-3. Z-Retainer Forms Gasket Cavity

respect to gasket height. Suggested retainer configurations are shown in Figures 3-2 and 3-3.

A basic difference between flanges constructed from sheet metal and those which are machined from castings is that the bolts cannot be located as close to the edge of the part when the flange is made of sheet metal. Note, in Figure 3-2, F is recommended to be $1.5 D$, where D is the diameter of the washer.

Flat gaskets are ordinarily used with sheet metal or machined flanges as typically illustrated in Figure 3-4. Bolt holes in the flanges should be located at least 1.5 times the bolt diameter from the edge of the flange to prevent tearing when the metal is punched.

If the holes are drilled, the position of the holes should be not less than the thickness of the gasket material

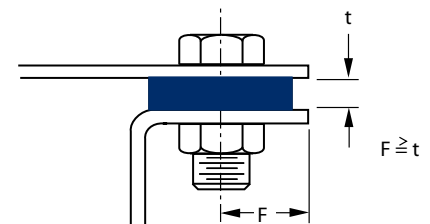

Figure 3-4. Flat Gasket on Sheet Metal Flange

from the edge of the flange. If holes must be placed closer to the edge than the recommended values, ears or slots should be considered as shown in Figure 3-5. Holes in flat gaskets should be treated in a similar manner.

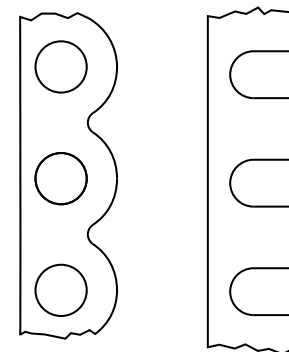

Figure 3-5. Ears or Slots in Sheet Metal Flanges or Flat Gaskets

4. Dimensional Tolerances

Grooves should be held to a machined tolerance of ± 0.002 in. Holes drilled into machined parts should be held to within ± 0.005 in. with respect to hole location. Location of punched holes should be within ± 0.010 in. Sheet metal bends should be held to $+0.030$ and -0.000 in. Gasket tolerances are given in the "Selection of Seal Cross Section," later in this guide.

5. Waveguide Flanges

The three concerns for waveguide flanges are to ensure maximum transfer of electromagnetic energy across the flange interface to prevent RF leakage from the interface, and to maintain pressurization of the waveguide. Conductive elastomeric gaskets provide both an electrical and a seal function. For flat cover flanges, a die-cut sheet gasket (CHO-SEAL 1239 material), incorporating expanded metal reinforcement to control gasket creep into the waveguide opening, provides an excellent seal. Raised lips around the gasket cut-out improve the power handling and pressure sealing capability of the gasket. Choke flanges are best sealed with molded circular D-Section gaskets, and contact flanges with molded rectangular D-gaskets in a suitable groove (both in CHO-SEAL 1212 material).

The peak power handling capabilities of waveguide flanges are limited primarily by misalignment and sharp edges of flanges and/or gaskets. Average power handling is limited by the heating effects caused by contact resistance of the flange-gasket interface ("junction resistance").

Selection of Seal Cross Section

Selection of the proper conductive elastomer gasket cross section is largely one of application, compromise, and experience with similar designs used in the past. Some general rules, however, can be established as initial design guidelines in selecting the class of gasket to be used.

1. Flat Gaskets

When using flat gaskets, care must be taken not to locate holes closer to the edge than the thickness of the gasket, or to cut a web narrower than the gasket thickness.

This is not to be confused with the criteria for punching holes in sheet metal parts discussed earlier.

Keep in mind also that flat gaskets should be deflected typically 10 percent, compared with 15 /18 percent for solid D / Soild O gaskets and 50% inside diameter for hollow gaskets. Standard thicknesses for flat gaskets are 0.020, 0.032, 0.045, 0.062, 0.093 and 0.125 in. (see General Tolerances, Table 3-2.)

Where possible, the flange should be bent outward so that the screws or bolts do not penetrate the shielded compartment (see Figure 3-6). If the flange must be bent inward to save space, the holes in the gasket must fit snugly around the threads of the bolts to prevent leakage along the threads and directly into the compartment. This calls for closely toleranced holes and accurate registration between the holes in the flange and the holes in the gasket, and would require machined dies (rather than rule dies) to produce the gasket. An alternate solution can be achieved by adding an EMI seal under the heads of bolts penetrating the enclosure, or by using an insert similar to an acorn nut that has been inserted in the flange and flared to make the joint RF-tight. "Blind nuts" can also be welded or attached with a conductive epoxy adhesive (see Figure 3-7).

2. Shaped or Molded Gaskets

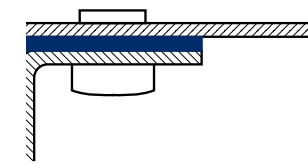

Figure 3-6. External Bolting Prevents EMI Leakage

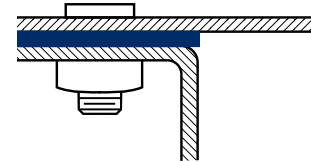

Figure 3-7. Insert Pressed-In and Flared Makes EMI Tight Joint (Alternate: Weld or Cement with Conductive Epoxy)

Groove designs for solid O and D configurations are more effective because these shapes accommodate a larger deflection range than a rectangular cross section (see Table 3-1), while maintaining a sufficient gasket loading for most weather sealing requirements. For lower closure force, and even more gasket deflection range, a hollow O, D, P or Mushroom D profile should be considered. However, these profiles may not provide weather sealing under challenging conditions because of their relatively lower compression loads.

Fasteners should be located such that pressure distribution is uniform at the corners (see Figure 3-8).

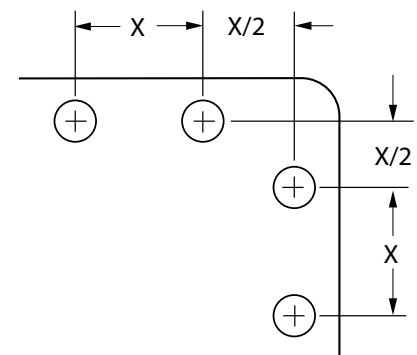

Figure 3-8. Fastener Location Near Corners

3. Hollow Gaskets

Hollow gasket configurations are very useful when large gaps are encountered, or where low closure forces are required. Hollow gaskets are often less expensive, and they can be obtained with or without attachment tabs. Hollow gaskets with tabs are referred to in the text and in the tables as "P-gaskets". The minimum wall thickness of hollow gaskets is typically 0.020 in. depending on material. Contact Chomerics' Applications Engineering Department for details. Hollow gaskets will compensate for a large lack of uniformity between mating surfaces because they can be compressed to the point of eliminating the hollow area.

4. Compression Limits

When compression cannot be controlled, compression stops should be provided to prevent gasket rupture caused by over-compression. Grooves provide built-in compression stops. Figure 3-9 and Table 3-1 gives nominal recommended compression ranges for CHO-SEAL and CHO-SEAL materials, assuming standard tolerances.

5. Elongation

The tensile strength of conductive elastomer gaskets is not high. It is

good practice to limit elongation to less than 10 percent.

6. Splicing

When grooves are provided for gasket containment, two approaches are possible. A custom gasket can be molded in one piece and placed into the desired groove, or a strip gasket can be spliced to length and fitted to the groove. To properly seat a spliced solid "O" cross section gasket, the inner radius of the groove at the corners must be equal to or greater than 1.5 times the gasket cross section diameter. Other cross sections need a greater inner radius and may not be practical due to twisting when bent around corners. Splices can be simply butted (with no adhesive) or bonded with a conductive or non-conductive compound. If it has been decided that a spliced gasket will provide a satisfactory seal, the decision between splicing and molding should be based on cost, flash and tolerance. When a standard extrusion is available, splicing is generally recommended. For custom extrusions, splicing is generally more cost effective in quantities over 500 feet.

7. Gasket Limitations Imposed by Manufacturing Methods

Current manufacturing technology

limits conductive elastomer gasket configurations to the following dimensions and shapes :

■ Die-cut Parts

Maximum Overall Size: 32 in. long x 32 in. wide x 0.125 in. thick (81 cm x 81 cm x 3.18 mm)

Minimum Cross Section: Width-to-thickness ratio 1:1 (width is not to be less than the thickness of the gasket).

■ Molded Parts

Currently available in any solid cross section, but not less than 0.040 in. in diameter. The outer dimensions of the gasket are limited to 34 inches in any direction. Larger parts can be made by splicing. Molded parts will include a small amount of flash (0.008 in. width and 0.005 in. thickness, maximum).

■ Extruded Parts

No limitation on length. Minimum solid cross-section is limited to 0.030 in. extrusions. Wall thickness of hollow extrusions varies with material but 0.020 in. can be achieved with most materials (S6308, 1215, 1273).

Table 3-1. Recommended Gasket Deflection

Recommended Deflection for Various Conductive Elastomer Shapes			
Cross Section Geometry	Min. Deflection	Nominal Deflection	Max. Deflection
Solid O	10% O.D.	18% O.D.	25% O.D.
Solid D	8% Height	15% Height	20% Height
Rectangular (including die-cut)	5% Height	10% Height	15% Height
Hollow O, D and P	10%-15%* O.D.	50% of inside opening	100% of inside opening

NOTE: For increased deflection requirements, Chomerics can provide specific shapes.
*15% on thin wall <0.030"
10% on walls ≥ 0.030"

Deflection Range	øW	Deflection Range	H	Deflection Range	T	Deflection Range	A	øB
0.007-0.018 (0.178-0.457)	0.070 (1.778)	0.005-0.014 (0.127-0.356)	0.068 (1.727)	0.001-0.003 (0.025-0.076)	0.020 (0.508)	0.020-0.080 (0.508-2.032)	0.200 (5.08)	0.080 (2.032)
0.010-0.026 (0.254-0.660)	0.103 (2.616)	0.007-0.018 (0.178-0.457)	0.089 (2.261)	0.002-0.005 (0.051-0.127)	0.032 (0.813)	0.025-0.125 (0.635-3.175)	0.250 (6.35)	0.125 (3.175)
0.013-0.031 (0.330-0.787)	0.125 (3.175)	0.010-0.026 (0.254-0.660)	0.131 (3.327)	0.003-0.009 (0.076-0.229)	0.062 (1.575)	0.036-0.255 (0.914-6.477)	0.360 (9.144)	0.255 (6.477)
0.014-0.035 (0.356-0.889)	0.139 (3.531)	0.012-0.031 (0.305-0.787)	0.156 (3.962)	0.005-0.014 (0.127-0.356)	0.093 (2.362)			
		0.014-0.035 (0.356-0.889)	0.175 (4.445)					

Figure 3-9. Gasket Deflection Ranges

(mm dimensions in parentheses)

8. General Tolerances

Table 3-2 provides general tolerances for conductive elastomer gaskets. It is important to note that all flat die-cut, molded, and extruded gaskets are subject to free-state variation in the unrestrained condition. The use of inspection fixtures to verify conformance of finished parts is common and recommended where appropriate.

Also note that "Overall Dimensions" for flat die-cut gaskets and molded gaskets includes any feature-to-feature dimensions (e.g., edge-to-edge, edge-to-hole, hole-to-hole).

9. Gasket Cross Section Based on Junction Gaps

Gasket geometry is largely determined by the largest gap allowed to exist in the junction. Sheet metal enclosures will have larger variations than machined or die castings. The ultimate choice in allowable gap tolerance is a compromise between cost, performance and the reliability required during the life of the device. When a value analysis is conducted, it should be made of the entire junction, including the machining required, special handling,

treatment of the surfaces and other factors required to make the junction functional. Often, the gasket is the least expensive item, and contributes to cost-effectiveness by allowing loosely-toleranced flanges to be made EMI-tight.

The maximum gap allowed to exist in a junction is generally determined by the minimum electrical performance expected of the seal. A secondary consideration must be given to the barrier as a pressure seal if gas pressures of significant magnitude are expected. The gasket will blow out if the pressure is too high for the gap.

The minimum gap allowed in the junction is determined by the allowable squeeze that can be tolerated by the gasket material. Deflection of conductive elastomer gaskets is given in Figure 3-9. Flat gaskets may be deflected as much as 6-10 percent (nominal), depending on initial thickness and applied force. O-shaped gaskets are normally deflected 10 to 25 percent; however, greater deflections can be achieved by manipulating cross section configuration.

Determination of the exact gasket

thickness is a complex problem involving electrical performance, flange characteristics, fastener spacing and the properties of the gasket material. However, an initial estimate of the necessary thickness of a noncontained gasket can be determined by multiplying the difference in the expected minimum and maximum flange gaps by a factor of 4, as illustrated in Figure 3-10. A more detailed discussion, and a more accurate determination of gasket performance under loaded flange conditions, can be found in the Fastener Requirements section.

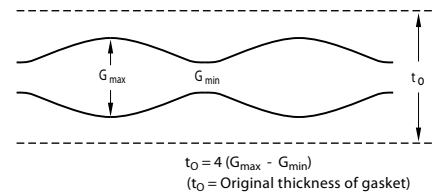

Figure 3-10. Gasket Deflection Along a Flange

Table 3-2. General Tolerances

FLAT DIE-CUT GASKETS		MOLDED GASKETS		EXTRUDED STRIP GASKETS	
inch (mm)	Tolerance	inch (mm)	Tolerance	inch (mm)	Tolerance
Overall Dimensions		Overall Dimensions		Cut Length	
≤10 (254)	±0.010 (0.25)	0.100 to 1.500 (2.54 to 38.10)	±0.010 (0.25)	<1.000 (25.40)	±0.020 (0.51)
>10 to ≤15 (254 to 381)	±0.020 (0.51)	1.501 to 2.500 (38.13 to 63.50)	±0.015 (0.38)	1.0 to 30.000 (25.40 to 762)	±0.062 (1.58)
>15 (>381)	±0.20% Nom. Dim.	2.501 to 4.500 (63.53 to 114.30)	±0.020 (0.51)	>30.000 (762)	±0.20% Nom. Dim.
Thickness		4.501 to 7.000 (114.33 to 177.80)		Cross Section	
0.020 (0.51)	±0.004 (0.10)	>7.000 (>177.80)	±0.35% Nom. Dim.	<0.200 (5.08)	±0.005 (0.13)
0.032 (0.81)	±0.005 (0.13)	Cross Section		0.200-0.349 (5.08-8.86)	±0.008 (0.20)
0.045 (1.14)	±0.006 (0.15)	0.039 to 0.069 (1.02 to 1.75)	±0.003 (0.08)	0.350-0.500 (8.89-12.70)	±0.010 (0.25)
0.062 (1.57)	±0.007 (0.18)	0.070 to 0.100 (1.78 to 2.54)	±0.004 (0.11)	>0.500 (12.70)	±3% Nom. Dim.
0.093 (2.36)	±0.010 (0.25)	0.101 to 0.200 (2.57 to 5.08)	±0.005 (0.13)		
0.125 (3.18)	±0.010 (0.25)	0.201 to 0.350 (5.11 to 8.89)	±0.008 (0.20)		
>0.125 (>3.18)	Contact a Chomerics Applications or Sales Engineer				
Hole Diameters	+/- 0.010 (0.25)				
Location of Hole Center ±0.010 (0.25)					

FASTENER REQUIREMENTS

1. Applied Force

Most applications do not require more than 100 psi (0.69 MPa) to achieve an effective EMI seal. Waveguide flanges often provide ten times this amount. Hollow strips require less than 10 pounds per in. Compression deflection data for many shapes, sizes and materials is included in the Performance Data section of this Design Guide.

The force required at the point of least pressure, generally midway between fasteners, can be obtained by using a large number of small fasteners spaced closely together. Alternatively, fasteners can be spaced further apart by using stiffer flanges and larger diameter bolts. Sheet metal parts require more fasteners per unit length than castings because they lack stiffness.

To calculate average applied force required, refer to load-deflection curves for specific gasket materials and cross sections (see Performance Data).

2. Fastener Sizes and Spacing

Fastener spacing should be determined first. As a general rule, fasteners should not be spaced more than 2.0 inches (50 mm) apart for stiff flanges, and 0.75 inch (19 mm) apart for sheet metal if high levels of shielding are required. An exception to the rule is the spacing between fasteners found in large cabinet doors, which may vary from 3 inches (76.02 mm) between centers to single fasteners (i.e., door latches). The larger spacings are compensated for by stiffer flange sections, very large gaskets, and/or some reduction in electrical performance requirements.

The force per bolt is determined by dividing the total closure force by the number of bolts. Select a fastener with a stress value safely below the allowable stress of the fastener.

3. Flange Deflection

The flange deflection between fasteners is a complex problem involving the geometry of the flange and the asymmetrical application of forces in two directions. The one-dimensional solution, which treats the flange as a simple beam on an elastic foundation, is much easier to analyze and gives a good first order approximation of the spacings required between fasteners, because most EMI gaskets are sandwiched between compliant flanges

Variation in applied forces between fasteners can be limited to ± 10 percent by adjusting the constants of the flange such that

$$\beta d = 2,$$

where

$$\beta = \sqrt[4]{\frac{k}{4 E_f I_f}}$$

k = foundation modulus of the seal
 E_f = the modulus of elasticity of the flange
 I_f = the moment of inertia of the flange and seal

d = spacing between fasteners

The modulus of elasticity (E_f) for steel is typically 3×10^7 . The modulus for aluminum is typically 1×10^7 , and for brass it is about 1.4×10^7 .

The foundation modulus (k) of seals is typically 10,000 to 15,000 psi.

The moment of inertia (I_f) of rectangular sections, for example, may be obtained from the following expression²:

$$\text{where } I_f = \frac{bh^3}{12}$$

b = the width of the flange in contact with the gasket (inches) and
 h = the thickness of the flange (inches).

Example

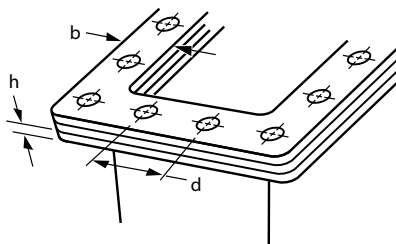

Figure 3-11. Bolt Spacings for Flanges

Calculate the bolt spacings for flanges with a rectangular cross-section, such as shown in Figure 3-11, where

h is the thickness of the flange.
 b is the width of the flange.

d is the spacing between fasteners.

Assume the flange is to be made of aluminum.

To maintain a pressure distribution between bolts of less than ± 10 percent, βd must be equal to 2 (see Figure 3-12 and discussion).

Assume an average foundation modulus (k) of 12,500 psi for the

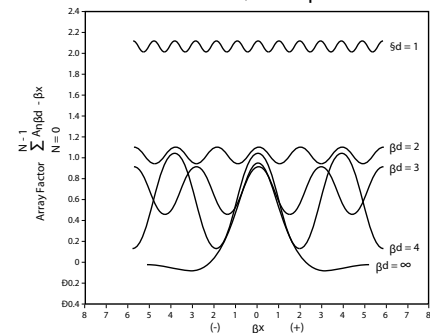

Figure 3-12. Array Factor vs. Spacing

seal. If the actual modulus is known (stress divided by strain), substitute that value instead.

The bolt spacings for aluminum flanges for various thicknesses and widths have been calculated for the previous example and are shown in Figure 3-13.

The previous example does not take into account the additional stiffness contributed by the box to which the flange is attached, so the results are somewhat conservative.

Actual deflection vs. distance between fasteners may be computed from the following expression:

where p is the force applied by the fastener, and k are the constants of the flange

$$y = \frac{\beta p}{2k} \sum_{n=0}^{N-1} A_{n\beta d - \beta x}$$

as determined previously. N represents the number of bolts in the array.

References

- Galagan, Steven, *Designing Flanges and Seals for Low EMI, Microwaves*, December 1966.
- Roark, R. J., *Formulas for Stress and Strain*, McGraw-Hill, 4th Ed., p. 74.

The array factor denoted by the summation sign adds the contribution of each fastener in the array. The array factor for various bolt spacings (βd) is shown in Figure 3-13. Although any value can be selected for βd , a practical compromise between deflection, bolt spacing and electrical performance is to select a bolt spacing which yields a value βd equal to 2.

For $\beta d = 2$, the flange deflection fluctuates by ± 10 percent. Minimum deflection occurs midway between fasteners and is 20 percent less than the deflection directly under the

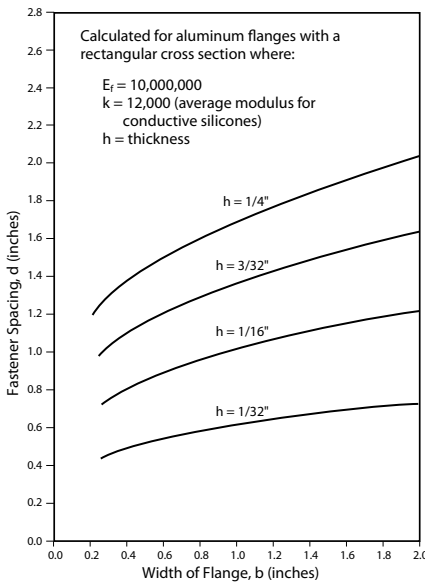

Figure 3-13. Fastener Spacing

fasteners. The variation in deflection is approximately sinusoidal.

Table 3-3 lists a few recommendations for bolts and bolt spacings in various thin cross section aluminum flanges.

Bolt spacings for waveguide flanges are fixed by Military and EIA Standards. Waveguide flanges normally have bolts located in the middle of the long dimension of the flange because the flow of current is most intense at this point.

Table 3-3: Bolt/Spacing Recommendations

SCREW SIZE	Centerline to Centerline (in.)	Cover Thickness (in.)	Max. Torque to Prevent Stripping for UNC-2A Thread (in.-lbs.)
#2	3/8	0.062	4.5
#4	3/4	0.125	10.0
#6	1	0.125	21.0
#8	1 1/4	0.156	37.5
#10	1 3/8	0.156	42.5

Table 3-4: Recommended Torque Values

For reference only. Actual torque values need to be calculated by the design engineer, for each individual application.

RECOMMENDED TORQUE VALUES FOR MILD STEEL BOLTS							
Size	Threads per in.	Max. Recommended				Basic Pitch Dia. (inches)	Basic Pitch Dia. (mm)
		Torque (in.-lbf)	Torque (Nm)	Tension* K = 0.20 (lbs.)	Tension* K = 0.20 (kN)		
#4	40	4.75	0.537	248	1.10	0.0958	2.433
	48	6	0.678	313	1.39	0.0985	2.433
#5	40	7	0.791	322	1.43	0.1088	2.764
	44	8.5	0.961	386	1.72	0.1102	2.799
#6	32	8.75	0.989	372	1.65	0.1177	2.990
	40	11	1.243	452	2.01	0.1218	3.094
#8	32	18	2.034	626	2.79	0.1437	3.650
	36	20	2.260	685	3.05	0.1460	3.708
#10	24	23	2.599	706	3.14	0.1629	4.138
	32	32	3.616	943	4.19	0.1697	4.310
1/4"	20	80	9.040	1839	8.18	0.2175	5.525
	28	100	11.300	2205	9.81	0.2268	5.761
5/16"	18	140	15.820	2533	11.27	0.2764	7.021
	24	150	16.950	2628	11.69	0.2854	7.249
3/8"	16	250	28.250	3738	16.63	0.3344	8.494
	24	275	31.075	3952	17.58	0.3479	8.837
7/16"	14	400	45.200	5114	22.75	0.3911	9.934
	20	425	48.025	5247	23.34	0.4050	10.287
1/2"	13	550	62.150	6111	27.18	0.4500	11.430
	20	575	64.975	6150	27.36	0.4675	11.875
9/16"	12	725	81.925	7130	31.72	0.5084	12.913
	18	800	90.400	7599	33.80	0.5264	13.371
5/8"	11	1,250	141.250	11,042	49.12	0.5660	14.376
	18	1,400	158.200	11,887	52.87	0.5889	14.958

$$*Tension = \frac{Torque (in-lbf \text{ or } Nm)}{K \times Bolt \text{ Dia (in or m)}^f}$$

K is the Nut Factor, sometimes called the friction factor. The value of K depends on several components and can vary from reference to reference. Two typical examples of K are given below and many more exist.

- K = 0.20 Dry (un-lubricated) mid-size steel bolt
- K = 0.15 Lubricated bolt

^fBasic Pitch Diameter

4. Common Fasteners

Many different types of fasteners are available, but bolts are the most widely used fastening devices. The approximate torque required to apply adequate force for mild steel bolts is shown in Table 3-4.

These values are approximate and will be affected by the type of lubricants used (if any), plating, the type of washers used, the class and finish of the threads, and numerous other factors.

The final torque applied to the fasteners during assembly should be 133 percent of the design value to overcome the effect of stress-relaxation. When torqued to this value, the gasket will relax over a period of time and then settle to the design value.

Torque may be converted to tension in the bolts by applying the formula in Table 3-4.

Frequently the general value of 0.2 for the coefficient of friction can result in torque and bolt estimates which may be seriously in error. Excessive bolt preload may lead to RF leakage. Therefore, if lubricants are used for any reason, refer to the literature for the proper coefficient values to be applied.

In soft materials, such as aluminum, magnesium and insulating materials, inserts should be provided if the threads are "working threads." A thread is considered a "working thread" if it will be assembled and disassembled ten or more times.

Torque loss caused by elongation of stainless steel fasteners should also be considered. High tensile strength hardware is advised when this becomes a problem, but care must be taken of the finish specified to minimize galvanic corrosion.

Thermal conductivity of high tensile strength hardware is lower than most materials used in electro-mechanical packaging today, so that the enclosure expands faster than the hardware and usually helps to

tighten the seal. Should the equipment be subjected to low temperatures for long periods of time, the bolts may require tightening in the field, or can be pretightened in the factory under similar conditions.

Under shock and vibration, a stack up of a flat washer, split helical lockwasher and nut are the least reliable, partly because of elongation of the stainless steel fasteners, which causes the initial loosening. The process is continued under shock and vibration conditions. Elastic stop nuts and locking inserts installed in tapped holes have proven to be more reliable under shock and vibration conditions, but they cost more and are more expensive to assemble.

5. Electrical Performance as a Function of Fastener Spacing

For bolt spacings equal to or approaching one-half wavelength at the highest operating frequency being considered, the shielding effectiveness at the point of least pressure is the governing value.

For example, assume that a gasket is sandwiched between two flanges which, when fastened together with bolts, have a value of βd equal to 2. Figure 3-12 shows that a value of $\beta d = 2$ represents a deflection change of ± 10 percent about the mean deflection point. Because applied pressure is directly proportional to deflection, the applied pressure also varies by ± 10 percent.

Shielding effectiveness values for typical silver-plated-copper filled, die-cut gaskets as a function of applied pressure are shown in Figure 3-14. The curves show that the shielding effectiveness varies appreciably with applied pressure, and changes as a function of the type of field considered. Plane wave attenuation, for example, is more sensitive to applied pressure than electric or magnetic fields.

Thus, in determining the performance

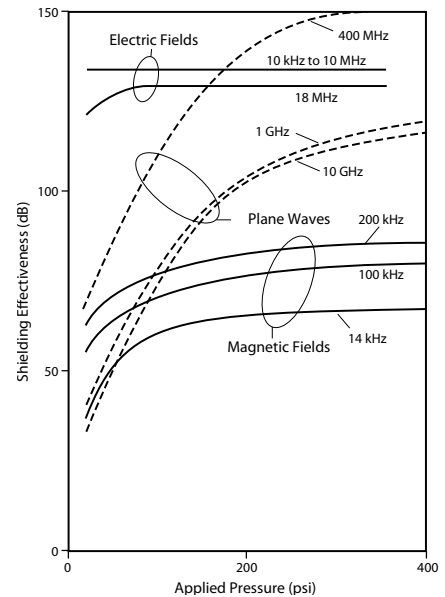

Figure 3-14. Shielding Effectiveness vs. Applied Pressure

to be expected from a junction, find the value for an applied pressure which is 10 percent less (for $\beta d = 2$) than the value exerted by the bolts directly adjacent to the gasket. For example, examine a portion of a typical gasket performance curve as shown in Figure 3-15.

The average shielding effectiveness of the gasketed seam is a function of the mean applied pressure, p_m .

For spacings which approach or are equal to one-half wavelength, the shielding effectiveness is a function of the minimum pressure, p_1 . Therefore, the applied pressure must be 20 percent higher to achieve the required performance.

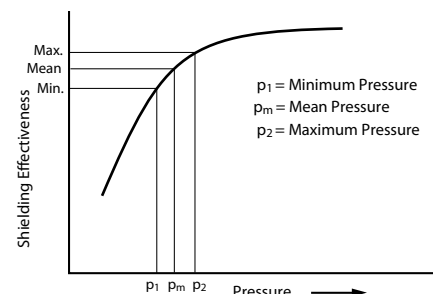

Figure 3-15. Typical Gasket Performance Curve

For this condition, the space between the fasteners can be considered to be a slot antenna loaded with a lossy dielectric. If the slot is completely filled, then the applied pressure must be 20 percent higher as cited. Conversely, if the slot is not completely filled (as shown in Figure 3-16), the open area will be free to radiate energy through the slot.

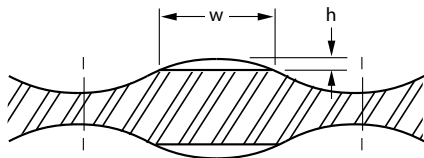

Figure 3-16. Unfilled Slot is Free to Radiate When Spacing is Equal to 1/2 Wavelength

The cut-off frequency for polarizations parallel to the long dimension of the slot will be determined by the gap height, h . The cut-off frequency for the polarization vector perpendicular to the slot will be determined by the width of the slot, w . The attenuation through the slot is determined by the approximate formula:

$$A(\text{dB}) = 54.4d / \lambda c$$

where

d = the depth of the slot,

and

λc is equal to $2w$ or $2h$,
depending upon the
polarization being considered.

This example also illustrates why leakage is apt to be more for polarizations which are perpendicular to the seam.

For large values of βd , the percentage adjustments must be even greater. For example, the percentage increase required to satisfy $\beta d = 3$ is 64 percent. It is desirable, therefore, that βd should be kept as small as possible. This can be achieved by using stiff flanges or spacing bolts closer together.

Designing a Solid-O Conductive Elastomer Gasket-in-a-Groove

The “solid-O profile” is the most often specified conductive elastomer EMI gasket for several key reasons. Compared to other solid cross sections, it offers the widest deflection range to compensate for poorly tolerated mating surfaces and to provide reliable EMI shielding and pressure sealing. It can be installed in a relatively small space, and is the most easily installed and manufactured. It also tends to be less prone to damage, due to the absence of angles, corners or other cross section appendages.

The “gasket-in-a-groove” design offers five significant advantages over surface-mounted EMI gaskets:

1. Superior shielding, due to substantial metal-to-metal contact achieved when the mating surfaces are bolted together and “bottom out”. (Flat die-cut gaskets prevent metal-to-metal contact between mating flange members, which reduces EMI shielding performance – especially in low frequency magnetic fields.)

2. Positive control over sealing performance. Controlling the size of the gasket and groove can ensure that required shielding and sealing are achieved with less careful assembly than is required for flat gaskets. In other words, the gasket-in-a-groove is more foolproof.

3. Built-in compression stop provided by the groove eliminates the risk of gasket damage due to excessive compression.

4. A gasket retention mechanism can be provided by the groove, eliminating the need for adhesives or mounting frames.

5. High current-handling characteristics of the metal-to-metal flange design improves the EMP and lightning protection offered by an enclosure.

This section presents the method for calculating groove and gasket dimensions which will permit the shielding system to function under worst-case tolerance conditions. Adherence to these general guidelines will result in optimum shielding and sealing for typical electronics “boxes”. It should be understood that they may not be suitable for designing shielding

for sheet metal cabinets, doors, rooms or other large, unconventional enclosures.

Important Notes:

The guidelines presented here are intended to consider only “solid O” gasket cross sections. The calculations for hollow O, solid and hollow D, and custom gasket cross sections differ from these guidelines in several key areas, refer to Table 4-1.

Chomerics generally does not recommend bonding solid O gaskets in grooves. If for some reason your design requires gasket retention, contact Chomerics’ Applications Engineering Department for specific recommendations, since the use of adhesives, dove-tailed grooves or “friction-fit” techniques require special design considerations not covered here, and may not be applicable to your specific application.

Extreme design requirements or unusually demanding specifications are also beyond the scope of the guidelines presented here. Examples would include critical specifications for pressure sealing, exceptionally high levels of EMI shielding, exceptional resistance to corrosion, harsh chemicals, high temperatures, heavy vibration, or unusual mounting and assembly considerations.

Mechanical Considerations Causes of Seal Failure

In order to produce a gasket-in-a-groove system which will not fail, the designer must consider three mechanical causes of seal failure: gasket over-deflection and associated damage (see Figure 3-20); groove over-fill, which can destroy the gasket (see Figure 3-21); gasket under-deflection as loss of seal (see Figure 3-22).

Designing to avoid these problems is made more complicated by the effects of:

- worst-case tolerance conditions
- deformation of the cover (cover bowing)
- poor fit of mating surfaces.

The key to success involves selection of the appropriate gasket size and material, and careful design of the corresponding groove.

Deflection Limits

In nearly every solid-O application, Chomerics recommends a minimum deflection of 10% of gasket diameter. This includes adjustments for all worst-case tolerances of both the gasket and groove, cover bowing, and lack of conformity between mating surfaces. We recommend not exceeding a maximum gasket deflection of 25% of gasket diameter, considering all gasket and groove tolerances. Keeping with these limits, the overall design goal is 18% nominal compression of the gasket.

Although sometimes modified to accommodate application peculiarities, these limits have been established to allow for stress relaxation, aging, compression set, elastic limits, thermal expansion, etc.

Maximum Groove Fill

Solid elastomer gaskets (as opposed to foam elastomer gaskets) seal by changing shape to conform to mating surfaces. They should be considered as incompressible fluids, and therefore cannot change volume. The recommended limit is 97% groove fill under worst-case tolerances of both gasket and groove. The largest gasket cross sectional area must fit into the smallest cross sectional groove area.

Analyzing Worst-Case Tolerances

Figures 3-17 through 3-19 illustrate the issues of concern, and identify the parameters which should be considered in developing an effective design.

Figures 3-20 and 3-21 illustrate two different cases which can result in gasket damage in the area of torqued bolts. In Figure 3-20, the relationship between groove depth and gasket diameter is critical in avoiding over-deflection. In Figure 3-21, sufficient groove volume must be provided for a given gasket volume to permit the gasket to deflect without over-filling the groove.

As shown in Figure 3-22, cover deformation and groove sizing must be controlled to make sure the gasket is sufficiently deflected to seal the system.

Since a single gasket and groove are employed for the entire perimeter, the design must be optimized for each of the worst-case examples illustrated in Figures 3-20 through 3-22.

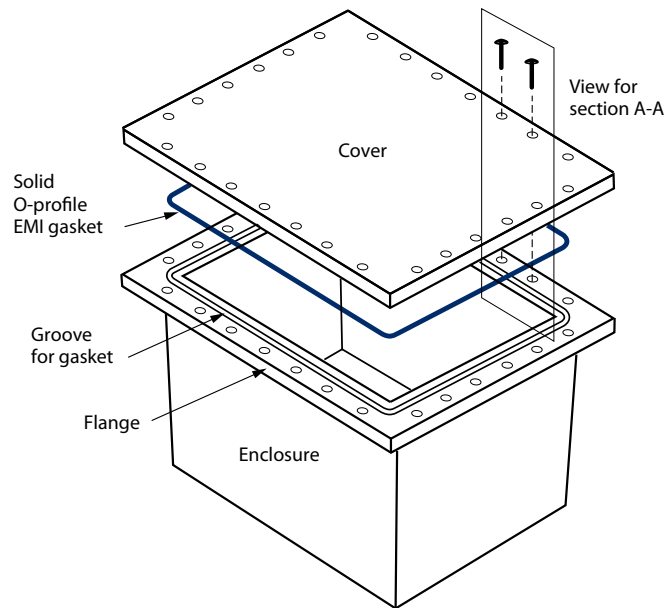

Figure 3-17. Exploded View of Electronic Enclosure

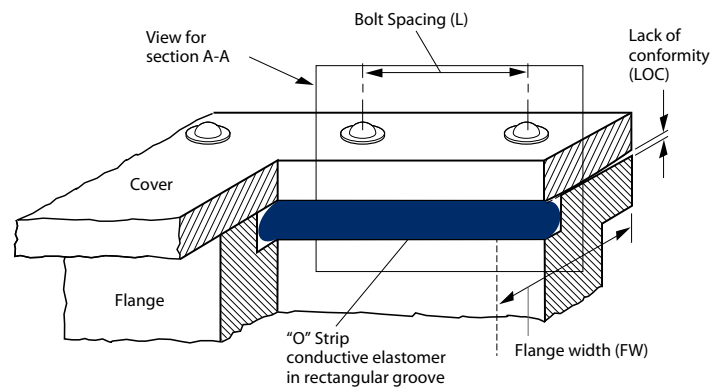

Figure 3-18. Cut-away View of Assembly

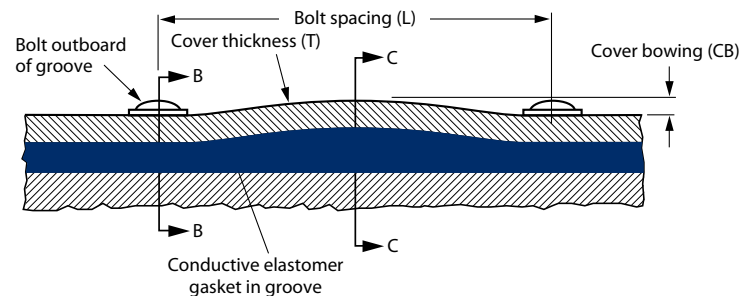
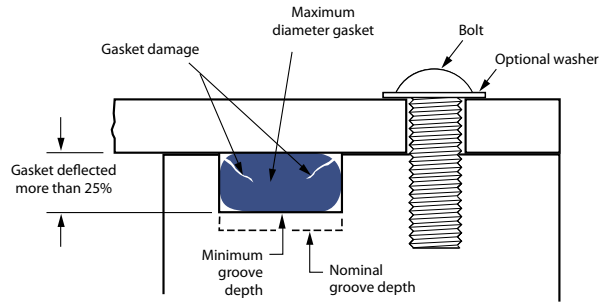

Figure 3-19. Section A-A of Assembled Enclosure Flange and Gasket (Sectioned midway through gasket and groove)

Figure 3-20 Section B-B from Figure 3-19 – Worst Case Maximum Deflection (Maximum gasket diameter, minimum groove depth)

Problem: Gasket too tall for minimum groove depth (deflection beyond elastic limit). Results in gasket damage or fracture.



Solution: Over-deflection avoided with smaller maximum gasket diameter and/or deeper minimum groove depth.

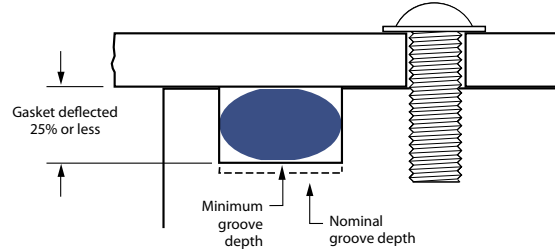
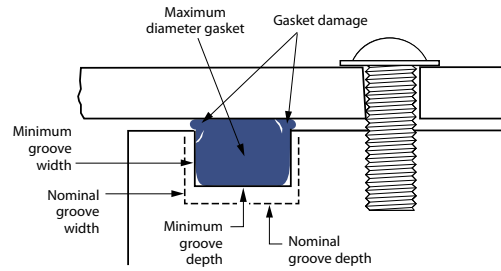

Figure 3-21 Section B-B from Figure 3-19 – Worst Case Maximum Groove Fill (Maximum gasket diameter in minimum groove depth and width)

Problem: Minimum groove dimension cannot accommodate maximum gasket diameter, resulting in gasket damage.



Solution: Groove over-fill avoided with smaller maximum gasket diameter and/or greater minimum groove depth and/or width.

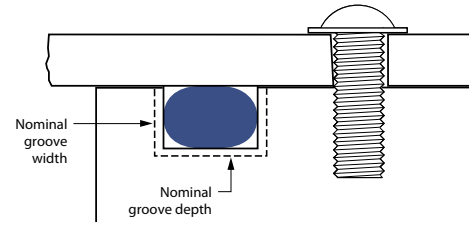
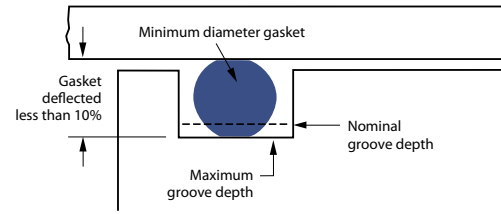
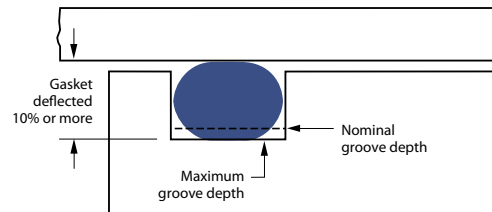

Figure 3-22 Section C-C from Figure 3-19 – Worst Case Minimum Deflection (Minimum gasket diameter in maximum depth groove, aggravated by cover bowing and lack of conformity between mating surfaces)

Problem: Gasket will not be deflected the recommended 10% minimum. Combined effects of tolerances, cover bowing, and lack of conformity can result in complete loss of cover-to-gasket contact over time, and consequent seal failure.



Solution: Under-deflection avoided with larger minimum gasket diameter and/or shallower maximum groove depth.



Calculating the Dimensions and Tolerances for the Groove and Solid O EMI Gasket

Figure 3-23 diagrams the calculation and decision sequence required to determine the dimensions for a Solid O groove system. Because the relationship between groove depth and gasket diameter is central to Solid O seal performance, groove depth is selected as the key variable to determine first.

Start by making an educated guess as to reasonable values for groove and gasket sizes and tolerances, based on desired nominal gasket deflection of 18%, see Table 4-1.

For example, if 0.025 in. of gasket deflection is desired, start with a nominal gasket diameter of 0.139 in. This is calculated by dividing the desired total gasket deflection by 0.18 to estimate the required gasket size. (Total Gasket Deflection \div 0.18 = Approx. Nominal Gasket Size.) This relationship is an alternate form of Formula 1 on the next page. Final groove dimensions can only be determined after completing all of the calculations called for in Figure 3-23, and arriving at values which remain within the recommended limits for gasket deflection and groove fill.

Figure 3-23. Procedure for Calculating Solid O Gasket and Groove Dimensions

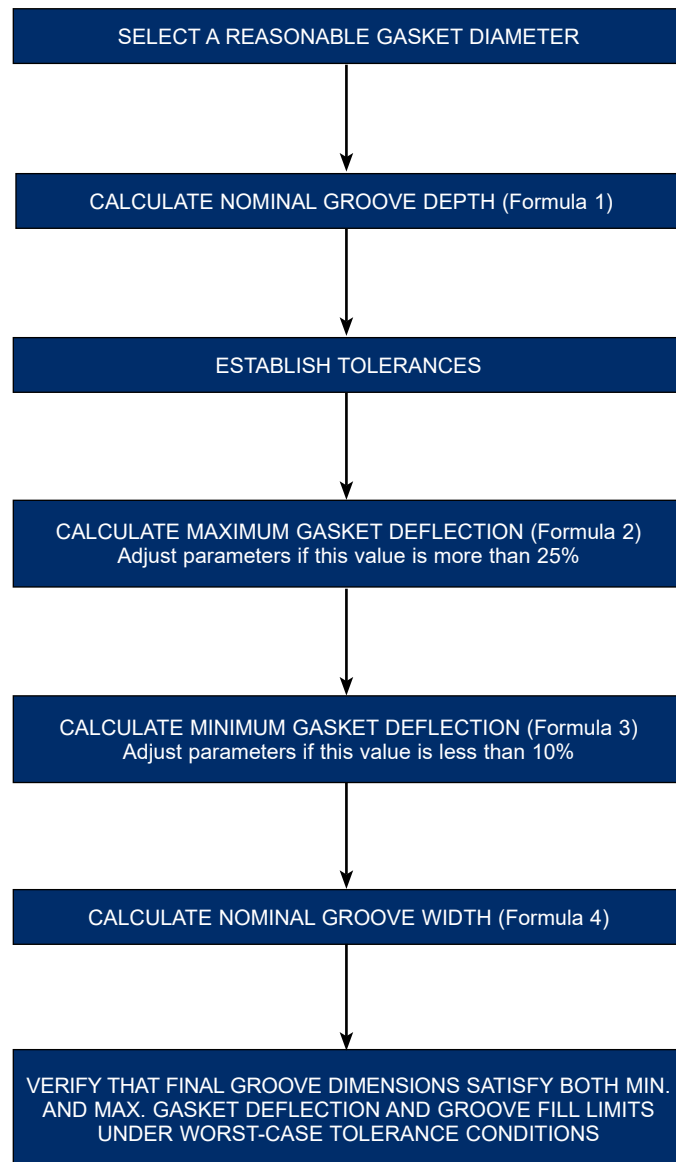

Formulas (see definition of terms at right)

1. Nominal Groove Depth

$$GrD_{nom} = 0.82 GaD_{nom}$$

2. Maximum Gasket Deflection

(Worst Case, expressed as a % of gasket diameter)

$$GaDf_{max} = 100 \left[\frac{(GaD_{nom} + GaT) - (GrD_{nom} - GrDT)}{(GaD_{nom} + GaT)} \right]$$

3. Minimum Gasket Deflection

(Worst Case, expressed as a % of gasket diameter)

$$a. GaDf_{min} = 100 \left[\frac{(GaD_{nom} - GaT) - (GrD_{nom} + GrDT) - CB - LOC}{(GaD_{nom} - GaT)} \right]$$

where

$$b. CB_{min} = \frac{GDF \times L_{max}^4}{FW_{min} \times T^3 \times E \times 32}$$

(Note: Formula must be adjusted when using metric units)

and

$$c. LOC = 0.001 \text{ in. for machined surfaces with surface roughness of } 32\text{-}64 \text{ } \mu\text{in. RMS.}$$

(For discussion, see Terms.)

4. Nominal Groove Width

$$a. GaA_{max} = 0.7854 * (GaD_{nom} + GaT)^2$$

$$b. GrW_{min} = \frac{GaA_{max}}{GrD_{min}}$$

$$c. GrW_{nom} = GrW_{min} + GrWT$$

$$*Note: 0.7854 = \frac{\pi}{4}$$

Terms

All values may be calculated in inches or mm unless otherwise indicated.

GaA_{max} – Maximum gasket cross section area (in² or mm²)

GaD_{nom} – Nominal gasket diameter

GaT – Gasket tolerance (difference between max. and nom. or min. and nom.)

GrW_{min} – Minimum groove width

GrWT – Groove width tolerance

GrW_{nom} – Nominal groove width

GrD_{min} – Minimum groove depth

GrD_{nom} – Nominal groove depth

GrDT – Groove depth tolerance (difference between max. and nom. or min. and nom.)

GaDf_{max} – Maximum gasket deflection (%)

GaDf_{min} – Minimum gasket deflection (%)

L_{max} – Maximum bolt spacing

FW_{min} – Minimum flange width

T_{min} – Minimum cover thickness

GDF – Gasket deflection force (ppi or Newtons per meter).

Note: For the purpose of this guide, the GDF value should represent the worst-case minimum gasket deflection arising from cover bowing. For example, the GDF is taken at 10% deflection for the calculation in Formula 3b.

E – Young’s modulus. (For aluminum, use 1 x 10⁷ psi, or 7 x 10⁵ kg/cm².)

CB – Cover bowing, generally calculated by modeling the elastic deformation of the cover as a uniformly loaded beam with two fixed supports. (The moment of inertia of the cover is modeled as a rectangular beam, the “height” of which is taken to be equal to the cover thickness, while “width” is considered equal to flange width. The moment of inertia can be adjusted for cover configurations other than flat. Refer to an engineering handbook for the necessary revisions to Formula 3b.) An assumption is made that one side of a cover/flange interface is infinitely stiff, typically the flange. If this is not essentially true, elastic deformation of each is computed as though the other were infinitely stiff, and the two values combined.

LOC – Lack of conformity, the measure of the mismatch between two mating surfaces when bolted together, expressed in inches. Experience has shown that machined surfaces with a surface roughness of 32-64 μin. RMS exhibit an LOC of 0.001 in. It is left to the engineer’s judgment to determine LOC for other surfaces. LOC can be determined empirically from measurements made of actual hardware. In this guide, LOC applies only to the surfaces which form the EMI shielding interface.

Gasket Mounting Choices

Our various EMI gasket mounting techniques offer designers cost-effective choices in both materials and assembly. These options offer aesthetic choices and accommodate packaging requirements such as tight spaces, weight limits, housing materials and assembly costs. Most Chomerics gaskets attach using easily repairable systems. Our Applications Engineering Department can provide full details on EMI gasket mounting. The most common systems are shown here with the available shielding products.

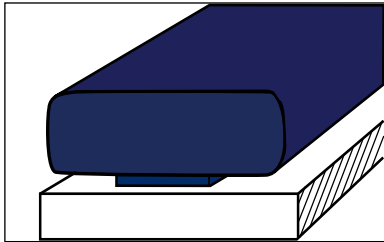

Pressure-Sensitive Adhesive

Quick, efficient attachment strip

- Molded sheets, cut parts and Extruded Conductive Elastomers

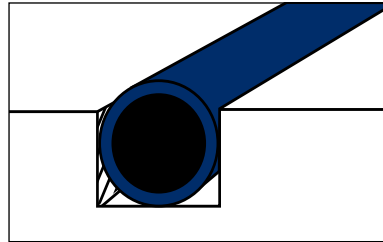

Friction Fit in a Groove

Prevents over-deflection of gasket
Retaining groove required

- Molded and Extruded Conductive Elastomers

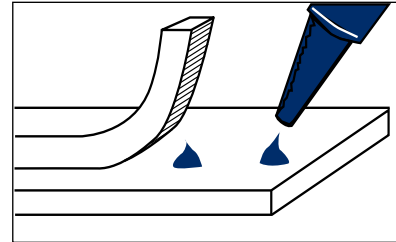

Adhesive Compounds

Spot bonding non-conductive or conductive spot bonding

- Conductive Elastomers

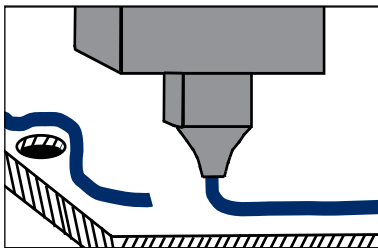

Robotically Dispensed Form-in-Place Conductive Elastomer

Chomerics' CHOFORM[®] automated technology applies high quality conductive elastomer gaskets to metal or plastic housings. Manufacturing options include Chomerics facilities and authorized Application Partners.

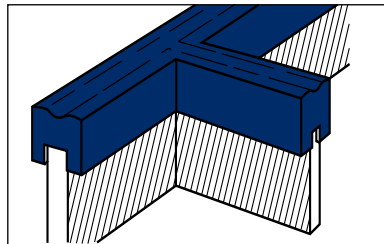

Friction Fit on Tangs

Accommodates thin walls, intricate shapes

- Conductive Elastomers

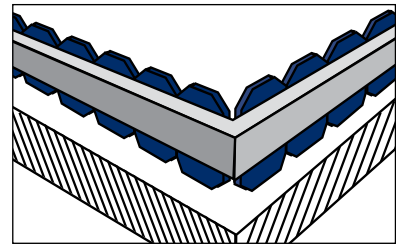

Spacer Gaskets

Fully customized, integral conductive elastomer and plastic spacer provide economical EMI shielding and grounding in small enclosures. Locator pins ensure accurate and easy installation, manually or robotically.

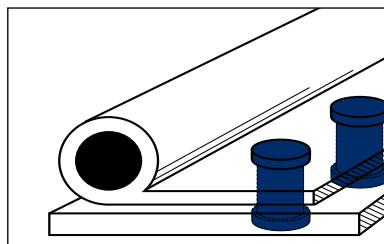

Rivets/Screws

Require integral compression stops
Require mounting holes on flange

- Conductive Elastomers

PRESSURE SENSITIVE ADHESIVE (PSA) BACKING

With regard to gasket electrical conductivity, Parker Chomerics does not recommend the addition/use of PSA. If a PSA system is deemed necessary, Chomerics offers the following guidance.

All published conductive elastomer electrical performance material specifications are for materials WITHOUT PSA backing. Depending on how they are used, a PSA system may reduce the gasket through flange conductivity and/or shielding effectiveness to varying degrees. We recommend the material be tested in the application to ensure the desired performance is achieved.

Applications such as an EMI connector gasket which requires the lowest electrical resistance ground connection should not incorporate a PSA system.

GENERAL APPLICATIONS GUIDANCE

Use of PSA as an attachment method for elastomer materials is meant to aid in initial assembly operations vs. a long term means of permanent attachment. The application method of gasket attachment is easy and effective with a clean surface. Simply clean the surface prior to mounting the gasket as defined on Page 32, surface preparation. Remove the release film and position the gasket using light pressure. When

the gasket is properly positioned, firmly press onto the flange.

ADVANTAGES

- Peel strength in excess of 4.5 pounds per inch of width (ppi)., for extruded parts.
- Extruded parts with PSA are available in continuous length or cut to length. (Note: Some cross sections cannot be packaged in continuous lengths).
- Eliminate fasteners or other adhesives.
- Can function as a “third hand” to facilitate difficult installations.
- Available with fluorosilicones as a permanent attachment method.
- Quick stick – readily adheres to clean surfaces.
- Conformable adhesion to curved surfaces.
- Resists humidity, moisture, natural elements.
- Eliminates alternative RTV solvent emissions and long set-up times.

DISADVANTAGES

- Not available on round cross-sections.
- Not recommended for applications where solvent resistance is essential.
- Not recommended for applications where resistance to excessive abuse due to moving parts or traffic is required.

Fluorocarbon and EPDM sheet stock materials are not available with PSA.

SHELF LIFE

Shelf life of the sheet stock with PSA is one year from date of manufacture. Sheet stock without adhesive has an indefinite shelf life.

PSA USE ON MOLDED SHEETS

All standard silicone and fluorosilicone SHEETS of .020 inch (0.51 mm) thickness or greater are available with a thin, acrylic, electrically conductive, pressure sensitive adhesive (PSA) backing.

If PSA is used, minimum deflection may need to be increased to obtain desired shielding results.

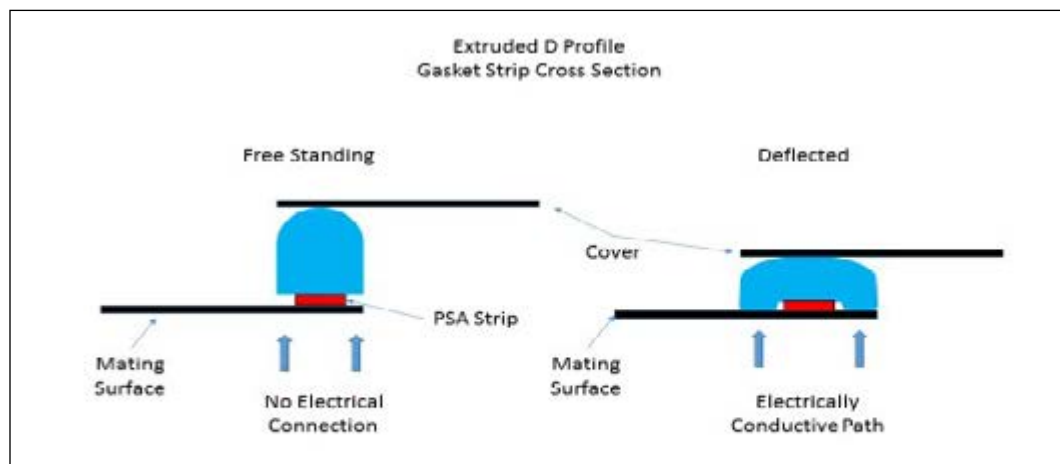

Figure 3-24

PRESSURE SENSITIVE ADHESIVE (PSA) BACKING - continued**PSA USE ON EXTRUDED STRIPS**

Some EXTRUDED STRIPS are provided with a non-conductive pressure sensitive adhesive (PSA) tape. This acrylic based PSA does not appreciably affect the through flange resistance of the EMI gasket because the PSA is typically sized to 50% of the gasket footprint. The remainder of the conductive gasket makes direct contact against the substrate as illustrated in Figure 3-24. The advantages of the non-conductive over a conductive PSA is that the non-conductive is stronger, doesn't add another galvanic couple to the interface and is more cost effective. This non-conductive pressure sensitive

adhesive (PSA) tape is available on most extruded profiles with a flat tape attachment area, such as D, P, K and Rectangular cross sections.

Minimum gasket deflection must be achieved and maintained to ensure gasket performance.

Typical properties for this adhesive used on our extruded conductive elastomers are shown in Table 3-5 below.

AVAILABLE WIDTHS OF PSA, INCH (MM)

- 0.050 (1.27)
- 0.090 (2.29)
- 0.125 (3.17) min. recommended
- 0.160 (4.06)
- 0.200 (5.08)
- 0.250 (6.35)
- 0.300 (7.62)
- 0.375 (9.53)
- 0.500 (12.70)

In general, pressure-sensitive adhesive requires a minimum of 0.125 inch (3.17 mm) flat mating surface. For this reason, Chomerics does not supply PSA on solid or hollow O strips.

Table 3-5: Pressure-Sensitive Adhesive - Typical Properties

	EXTRUSION	MOLDING
Adhesive Description	Pressure-sensitive acrylic with poly release liner	Pressure-sensitive acrylic filled with silver plated copper particles
Operating Temperature Range	-20 to 150°F (-29 to 66°C); PSA will function for short periods of time at 200°F (93°C); ultimate high temperature limit is 250°F (121°C).	-22 to 257°F (-30 to 125°C)
Shelf Life Conditions (from date of manufacture of elastomer with PSA)	1 year at 70°F (21°C)/50% RH	1 year at 70°F (21°C)/50% RH
Typical Peel Strength on Aluminum Per ASTM D1000, 90° peel	6.0 lb/inch (1.05 N/mm)	2.5 lb/inch (.438 N/mm)
Product Composition (thickness)	Composite 8.0 mil	1.5 mil
*Conductivity	N/A	<0.10 ohm/in ² (<0.0016 ohm/cm ²)
RoHS	Compliant	Compliant

*CEPS-0002 Test Method

Instructions for Surface Preparation and Installing Gaskets with PSA

SURFACE PREPARATION OF METALLIC SUBSTRATES

Optimal performance of the pressure-sensitive adhesive requires that the substrates to which these gaskets must adhere are cleaned prior to application. Chomerics has developed specific, easy-to-follow procedures for preparing the following substrates:

- Phosphate-coated steel
- Conversion-coated aluminum
- Stainless and mild steel

It is essential to follow these cleaning instructions to ensure maximum adhesion of the PSA to metal substrates. *Failure to comply with the appropriate cleaning process could result in poor adhesion. Proper safety precautions should be followed to protect the operator.*

MATERIALS REQUIRED:

3M Scotch-Brite® Pads or equivalent, Rubber gloves, Safety glasses, Lint-free cotton wipes; Methyl Ethyl Ketone (MEK), Acetone or Isopropyl Alcohol (IPA).

SURFACE PREPARATION OF CONVERSION-COATED ALUMINUM AND PHOSPHATE-COATED STEEL

1. Using a clean, lint-free cotton applicator, moistened with MEK, acetone or IPA, wash the aluminum surface until all traces of contamination have been removed.
2. Clean the surface until the cotton applicator shows no discoloration.

3. If discoloration still exists, continue washing, changing the cotton applicator each time, until clean. *Note: With phosphate coatings, it is very hard to remove all discoloration from the surface so it is up to the operator to determine the cleanliness of the surface prior to bonding. Typically, cleaning the surface 3 times is required.*
4. Allow the substrate to dry completely at room temperature. After the cleaning sequence is complete, do not touch the substrate with bare hands.
5. If the cleaned surfaces do not have the PSA'ed EMI gasket applied within an 8 hour period, rewash using the above process.

SURFACE PREPARATION OF STAINLESS OR MILD STEEL

1. Using a 3M Scotch-Brite® pad or equivalent, lightly abrade the steel surface.
2. Blow the dust residue off of the steel surface with oil-free filtered air.
3. Follow Steps 1 through 5 from the previous section to complete the surface preparation.

GASKET INSTALLATION PROCEDURE

1. For Extrusions, cut gasket material to specific lengths per drawing. If gasket is one piece, such as a four-corner spliced gasket, pre-fit the assembly to ensure fit and location.

2. For Molded sheets or die cut parts, prefit the gasket to ensure fit and location.
3. Remove a portion of the PSA release liner and position the gasket. Press firmly against the gasket to tack in place. Continue pressing along the entire length of gasket or surface area until it is positioned and aligned to the mating surface.
4. Using a rubber roller, apply moderate pressure to the entire gasket to ensure complete contact between the PSA and substrate. *Note: It is important during the rolling procedure that the operator not apply excessive pressure to the gasket. Extreme pressure will cause the gasket to elongate and creep as it relaxes, which may cause an intermittent bond to the substrate surface.*

OPTIMUM PSA APPLICATION TEMPERATURE

Temperatures below 50°F (10°C) can cause poor gasket adhesion to the substrate. The ideal gasket installation room temperature is 50-100°F (10-38°C) 60% RH, ambient room temperature. All materials should be stored at this temperature when not in use. Hardware and gasket materials stored below 50°F (10°C) should be brought to room temperature before installing gasket.

Performance Data: Conductive Elastomers

Compression-Deflection

While standard test procedures have been established for measuring the deflection of elastomers under compressive loads, the practical use of such data is to provide a qualitative comparison of the “deformability” of different elastomeric shape and material combinations. For solid elastomeric based materials, such as the CHO-SEAL product family, Chomerics uses a modified version of ASTM D575 where we define a 0.5 inch diameter sample size for sheet stock and define the speed of the compression versus deflection test (i.e. the cross head rate of compression).

Solid (non-foam) elastomers are essentially incompressible materials; i.e., they can change their shape, but cannot change their volume. So when a solid elastomer is subject to a compressive load, it yields by deformation of the part. Because of this behavior, the actual deflection of a gasket under a compressive load depends upon the size and shape of the gasket, as well as on its modulus and the magnitude of the load.

Table 4-1: Recommended Deflections

Recommended Deflection for Various Conductive Elastomer Shapes			
Cross Section Geometry	Min. Deflection	Nominal Deflection	Max. Deflection
Solid O	10% O.D.	18% O.D.	25% O.D.
Solid D	8% Height	15% Height	20% Height
Rect-angular (including die-cut)	5% Height	10% Height	15% Height
Hollow O, D and P	10%-15%* O.D.	50% of inside opening	100% of inside opening

NOTE: For increased deflection requirements, Chomerics can provide specific shapes.
*15% on thin wall <0.030”
10% on walls ≥ 0.030”

In addition, the presence of other features which restrict this gasket deformation, such as a groove wall, will also increase the compression load.

The design of an EMI seal should consider the shape of the cross section, independent of material and use the recommended gasket deflection ranges given below in Table 4-1. Going below the minimum compression target is unlikely to eliminate electrical contact resistance, and therefore deteriorate the desired shielding effectiveness. Gasket designs should avoid exceeding the maximum deflection limits shown in Table 4-1 to avoid damaging the enclosure structure and the EMI gasket material, which will also deteriorate the shielding effectiveness.

There is an approximate relationship between the forces required to deflect an unfilled elastomer a given amount, and the hardness of the elastomer. In general, the harder the elastomer, the greater the force required. However, in the case of Chomerics’ metal particle-filled elastomers, this relationship is much less definite, and in some instances, these materials demonstrate deflection/hardness and deflection/thickness behavior contrary to that which would be anticipated for conventional solid elastomer compounds.

The inclusion of metal particles in the elastomer results in a mechanically structured material. This mechanical structure has a marked effect on the deflection of the elastomer under compressive loads, and in some instances, harder materials deflect more than softer materials.

Compressive load-deflection data for many popular conductive elastomer materials and shapes are given in Graphs 4-1 thru 12. (For cord stock extruded strip gaskets, it is more convenient to express the load in terms of pounds-force per linear inch

of gasket instead of pounds per square inch).

It is not practical to provide compression deflection data for all gasket cross sections and/or possible groove combinations. Chomerics offers many unusual gasket cross sections. In addition, some of the smaller diameter cross sections create unique challenges due to gasket and enclosure tolerances. For compression-deflection data on these unique situations of other Chomerics gaskets, contact our Applications Engineering Department.

Note on Gasket Deflection and Closure Force:

We do not recommend basing material selection primarily on hardness. Unlike unfilled elastomers, material hardness is not always an accurate indicator of deflection properties. The geometry of the gasket is generally the most important determinant of deflection under load.

For applications requiring large gasket deflection with minimum closure force, a hollow part geometry is recommended. Contact Chomerics Applications Engineering for assistance where necessary.

Please refer to the product specification data included within the next several pages for technical information regarding:

- Compression-Deflection
- Stress Relaxation
- Compression Set
- EMP Survivability
- Vibration Resistance
- Heat Aging
- Outgassing
- Volume Resistivity

Sheet Stock Compression / Deflection Data

Graph 4-1

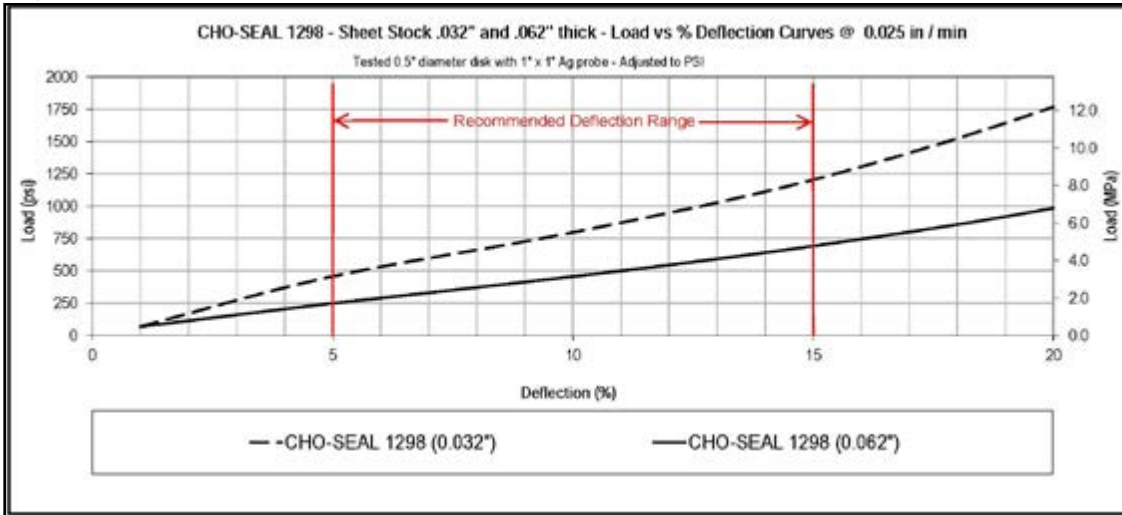

Graph 4-2

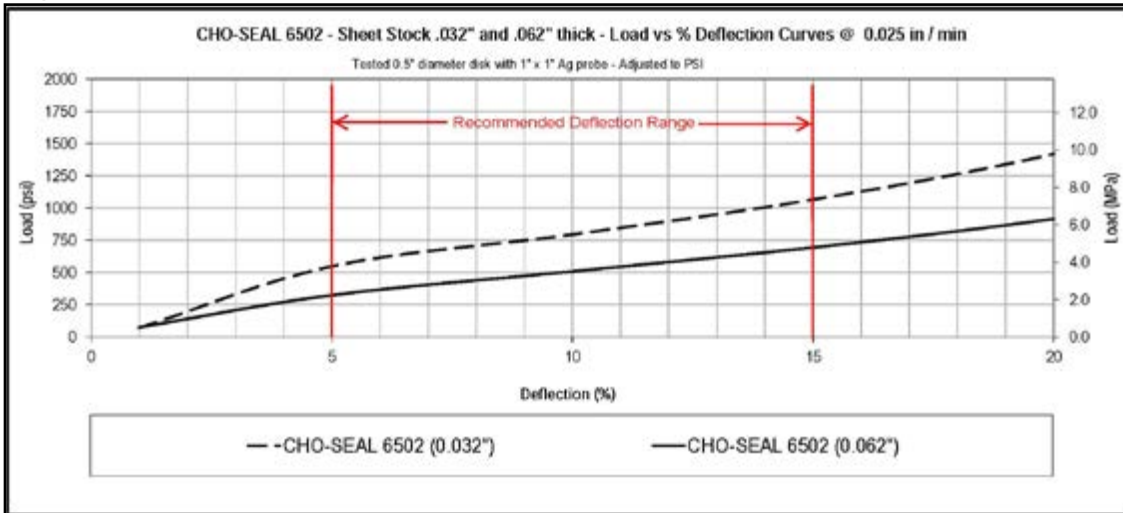

Graph 4-3

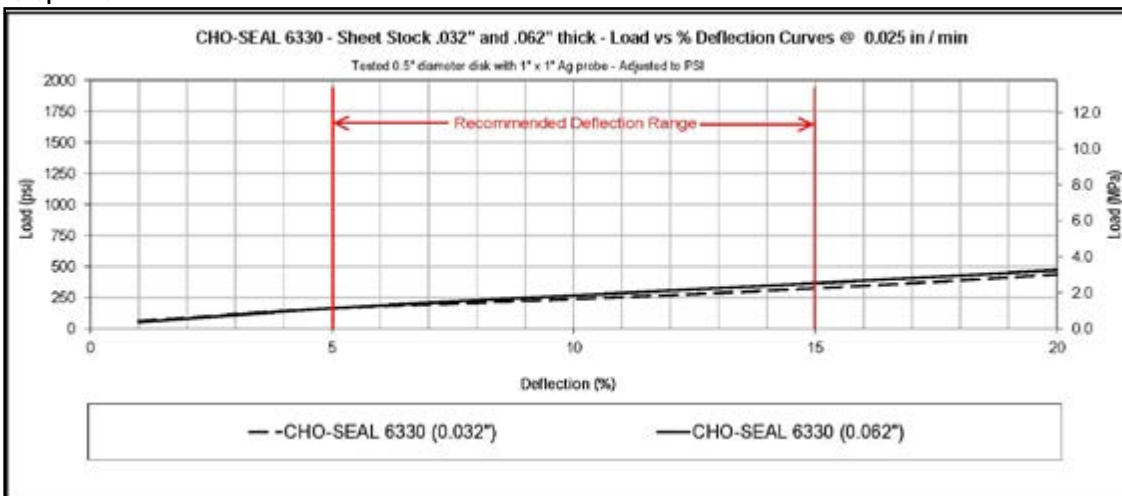

Performance

Sheet Stock Compression / Deflection Data - *continued*

Graph 4-4

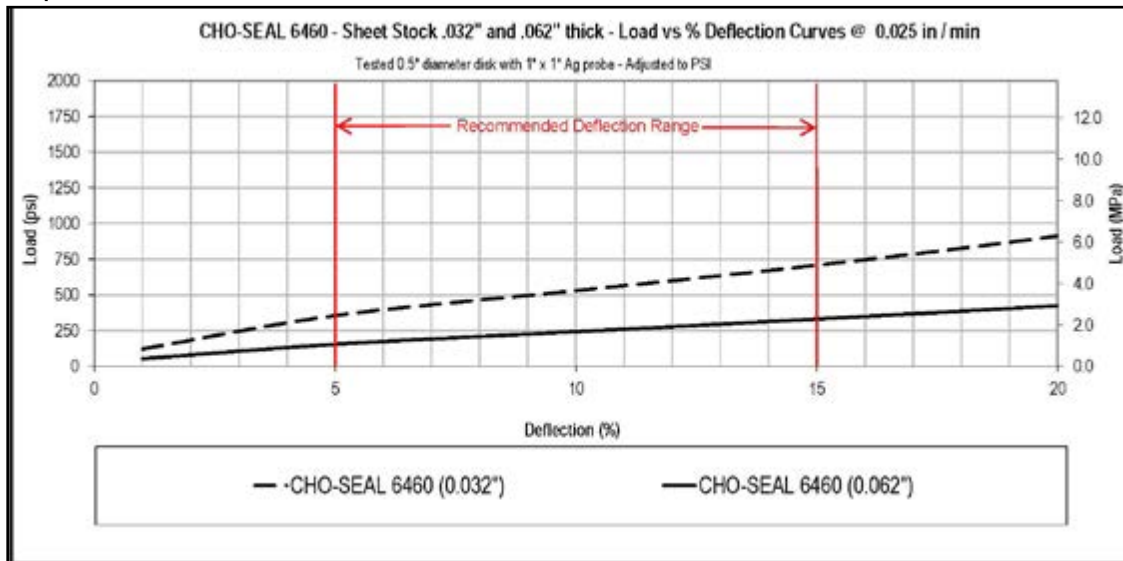

Graph 4-5

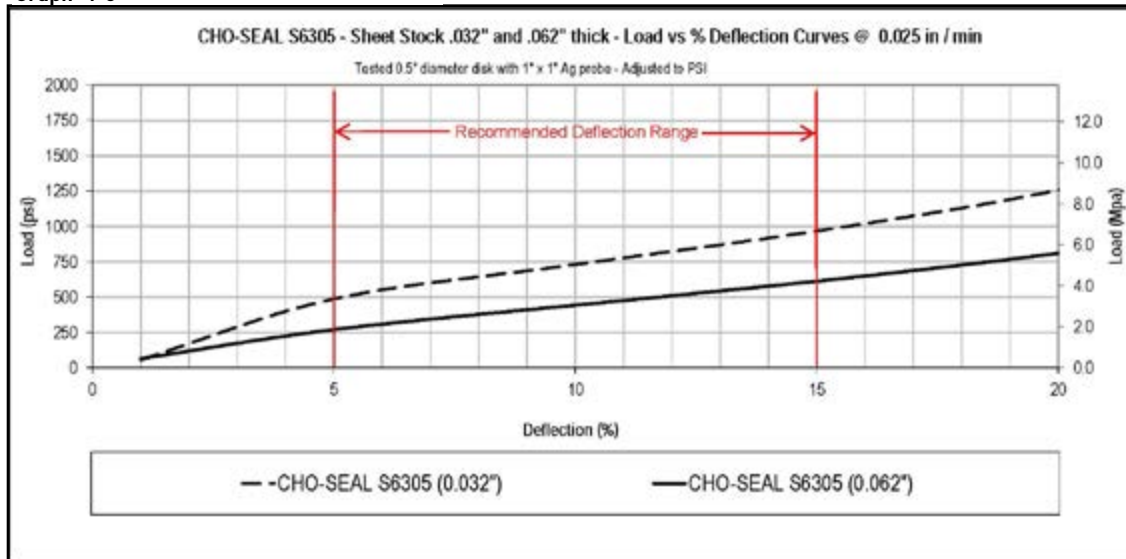

Extrusion Compression / Deflection Data

Graph 4-6

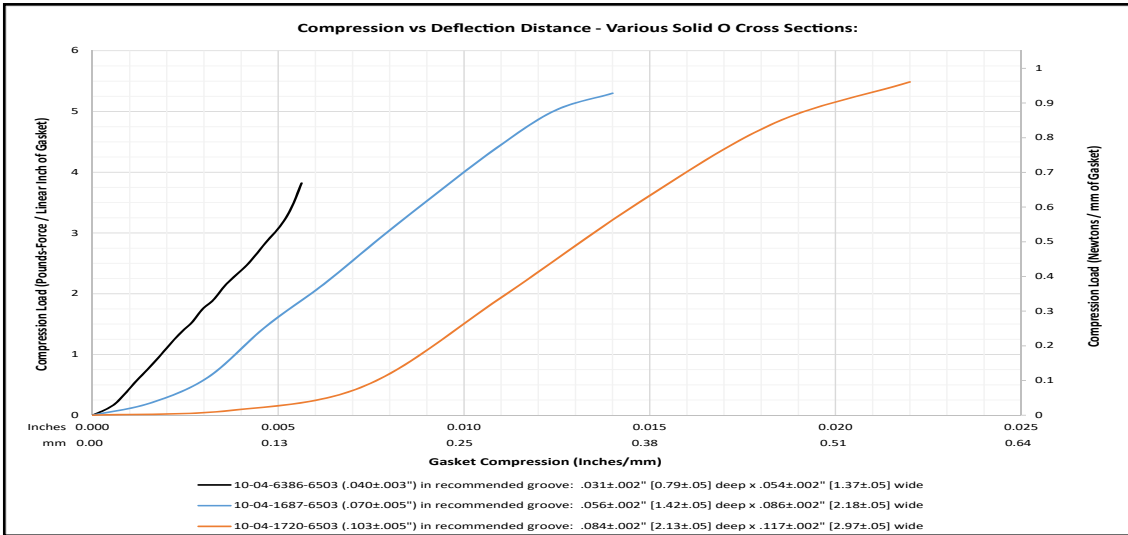

Graph 4-7

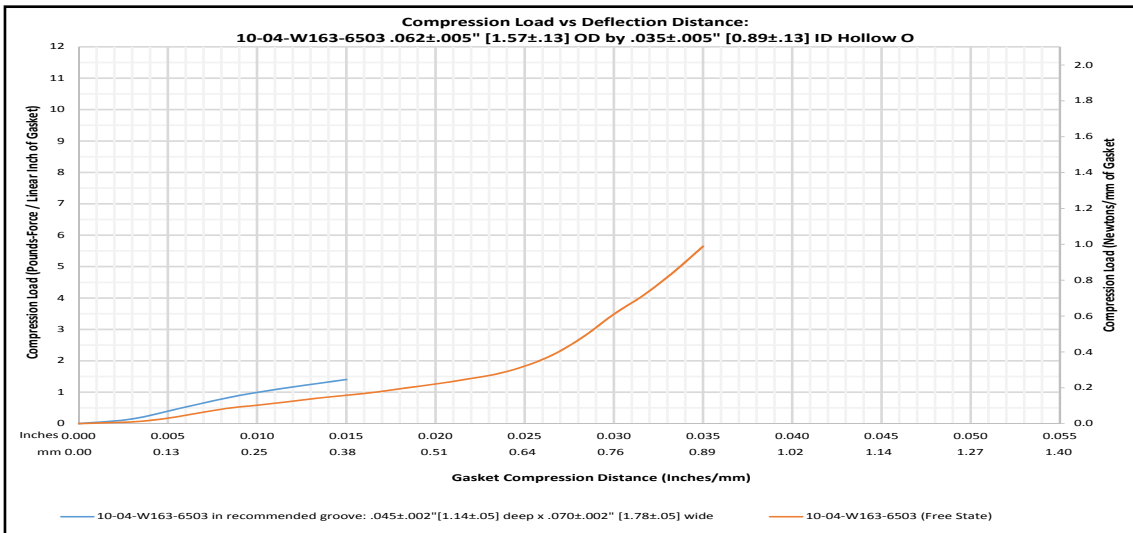

Graph 4-8

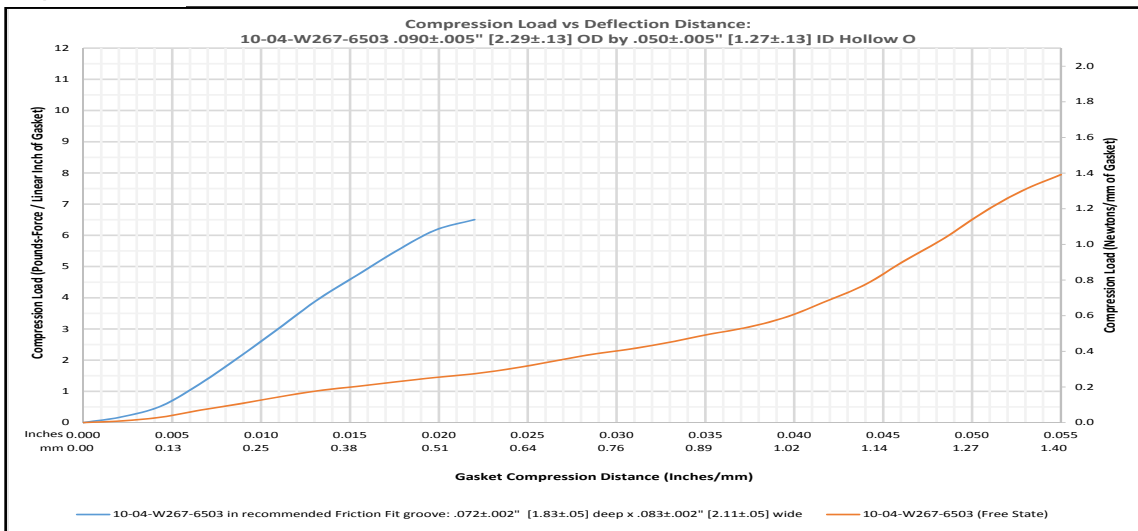

Performance

Extrusion Compression / Deflection Data - *continued*

Graph 4-9

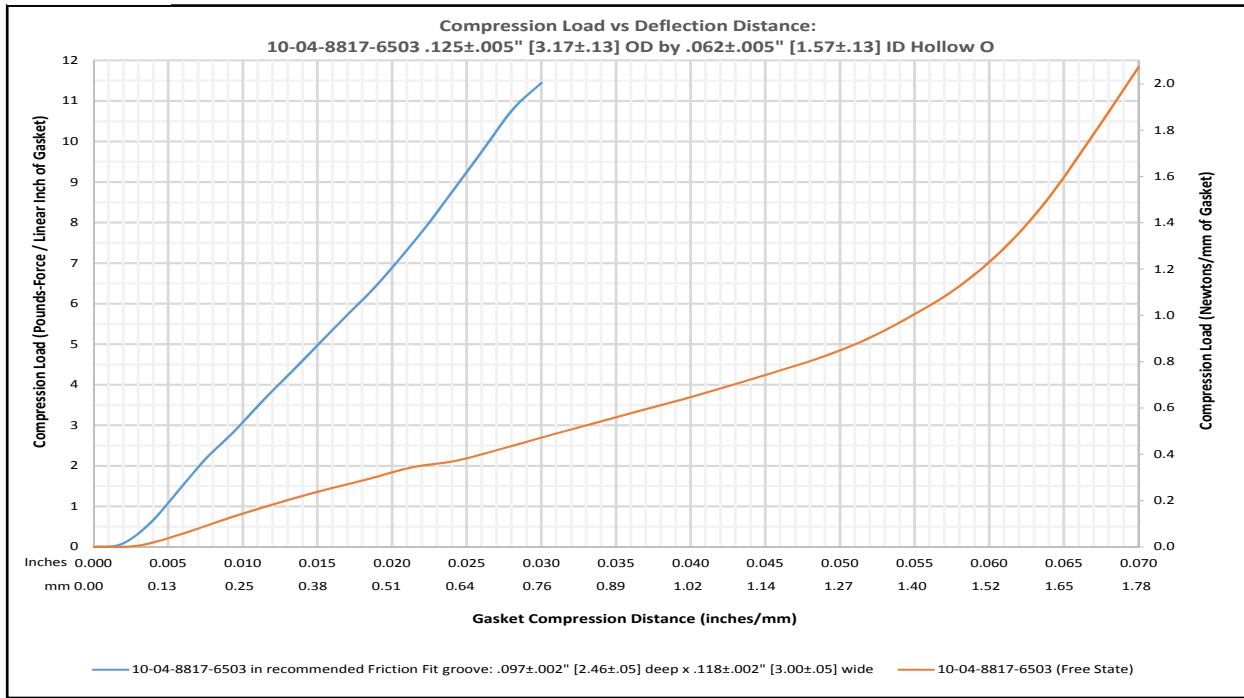

Performance

Graph 4-10

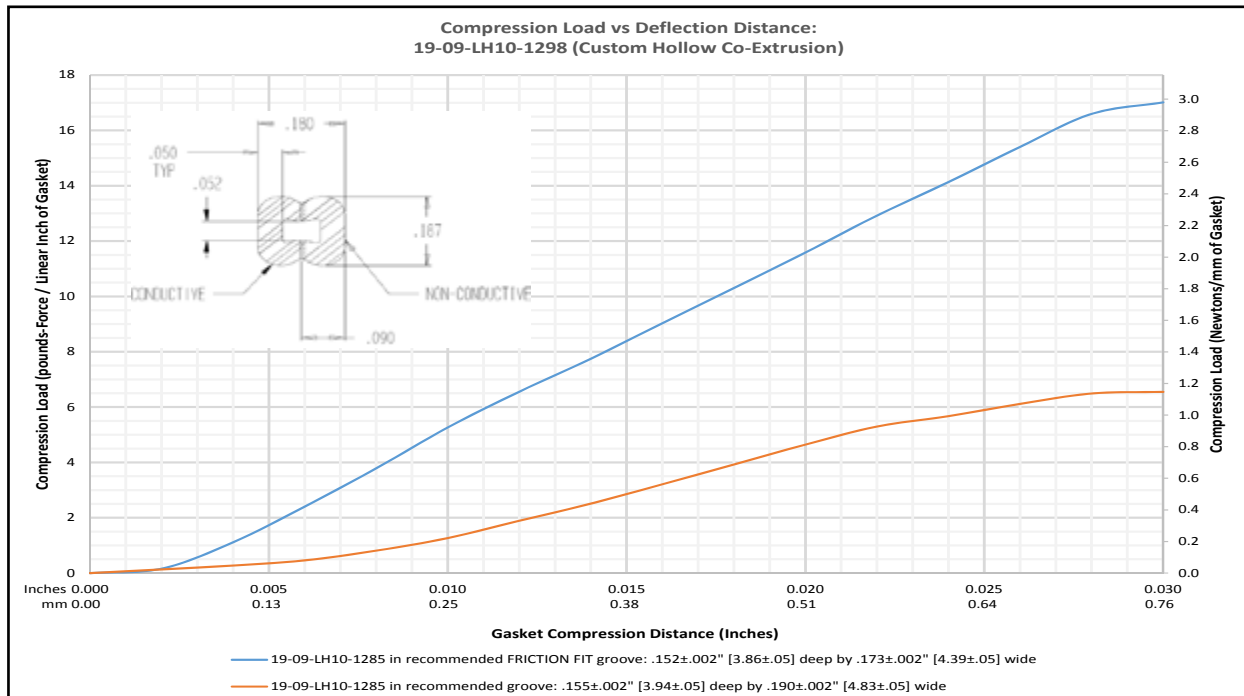

Stress Relaxation

As important as Compression Set and Compression-Deflection, is the Stress Relaxation characteristic of a gasket.

If an elastomer gasket is subject to a compressive load, it will deflect. There is a stress/strain relationship, which for an elastomer is generally non-linear except for very small deflections. After the load is applied, a stress decay occurs within the polymer resulting from the internal rearrangement of the molecular structure. An approximate rule is that the relaxed stress for cured silicone will finally settle at 70 to 75 percent of the initial stress.

There are two ways in which an elastomer gasket can be loaded to a desired value. One way is to load it to a point, let it relax, and reapply the load to restore the original stress. The next time it will relax, but not as much. If this is repeated a sufficient number of times, the correct static load on the gasket will reach equilibrium.

A more practical way to reach the design value of stress is to load the gasket to 125 percent of its final design value, so that after the relaxation process is completed the gasket will settle to 100 percent of the design load. This is very reproducible.

Graph 4-11 shows a typical stress relaxation curve for Chomerics' conductive elastomers.

Compression Set

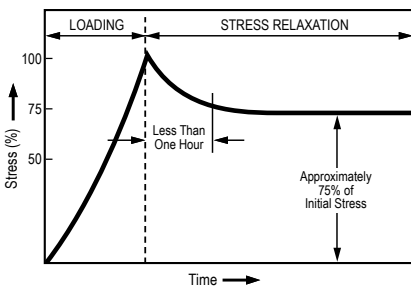

Graph 4-11. Stress Relaxation

When any elastomer is deformed for a period of time, some of the deformation is retained permanently even after the load is

removed. The amount of permanent deformation, as measured by ASTM D395, is termed "Compression Set." Compression set is measured under conditions of constant deflection (ASTM D395 Method B) and is normally expressed as a percentage of the initial deflection, not as a percentage of the initial height (Figure 4-1)

For gaskets that are used once, or where the gasket/flange periphery relationship is constant (such as a door gasket), compression set is of minor significance if the original load condition and the service temperature are within the design limitations of the gasket material.

For gaskets that are randomly resealed one or more times in normal service life, it is important that the maximum change in gasket thickness does not exceed twice the maximum mismatch between the opposing mating surfaces.

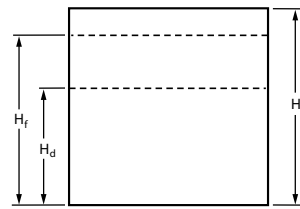

H_i = Initial height
 H_d = Deflected height (Normally 75% of H_i)
 H_f = Final height (After load is removed)

$$\text{Compression Set} = \frac{(H_i - H_f)}{(H_i - H_d)} \times 100\%$$

Figure 4-1. Formula for Calculation of Compression Set

Shielding Effectiveness

Understanding Shielding Effectiveness (SE) test data supplied from manufacturers of EMI gaskets and shielding materials can be a confusing trip down the land of the unknown. EMI gasket manufacturers have good intention when they publish test data on their material's that illustrate a gaskets has shielding effectiveness capability in excess of 120 – 150dB. In most cases a user will find that the shielding effectiveness they achieve in their own application is far short of the data published.

The actual gasket used for shielding effectiveness testing in these cases typically does not look anything like a

gasket used in an actual application. For example, in some cases the gasket used to create the test data for a catalog is 1 inch wide, 0.062 inch thick and is usually compressed between two flanges with ¼-20 bolts which are 2 inches apart. Other than a few military shelters designed in the past, where have you ever seen this type of gasket design in common practice?

The type of test described above is also common with some EMI gasket material qualification standards such as MIL-DTL-83528. However, keep in mind this is simply a material qualification standard.

Parker Chomerics has developed a number of Shielding Effectiveness test methods that are intended to provide test data that the reader should expect to get in their own application.

Test data is provided in Parker – Chomerics based on MIL-DTL-83528, CHO-TP08 and CHO-TP09.

This outline is intended to explain the more common shielding effectiveness test methods, the methods used by Parker – Chomerics and the advantages and dis-advantages of each.

IEEE-STD-299 - This is the most fundamental shielding effectiveness test standard. The foundation of this document when created was originally MIL-STD-285 which was canceled in 1997. The most important thing to understand is that this standard is for testing shielding effectiveness of ELECTROMAGNETIC SHIELDED ENCLOSURES.

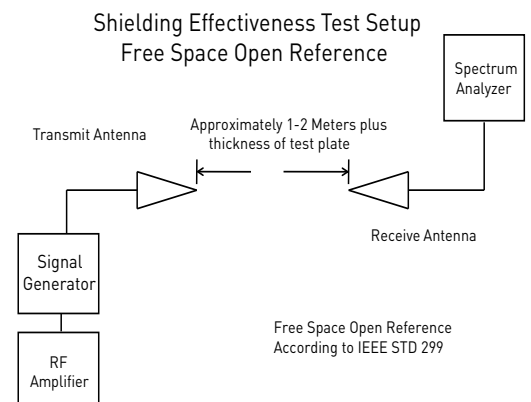

Figure 4-2. Free Space Open Reference

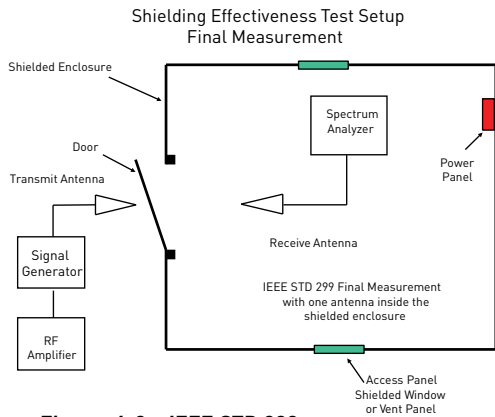

Figure 4-3. IEEE STD 299

Although a shielded enclosure is made up of EMI shielding materials as written, the standard is not an EMI shielding material test method. The general principle of the test method is to compare the level of a signal transmitted between two antennas in “free space” (Figure 4-2) to the signal level when one is put inside the shielded room (Figure 4-3). The test method covers magnetic fields (9kHz to 20MHz), electric fields (20MHz to 300MHz) and plane waves (300MHz to 18GHz). Occasionally the test method is used at extended frequencies both below 9kHz and above 18GHz. The standard requires the enclosure is tested a variety of positions, locations and antenna polarizations.

MIL-DTL-83528 – This is a CONDUCTIVE ELASTOMER EMI GASKET MATERIAL QUALIFICATION STANDARD. The standard includes test methods for a number of key EMI gasket elements including, Volume resistivity, Temp, Vibration Electromagnetic Pulse (EMP, as well as shielding effectiveness. Each different conductive elastomer material is classified as a different Material Type with associated limits.

The EMP test method ensures that a gasket material can transfer a current pulse of 9KA through the material to simulate the EMP phenomena and maintain the specified volume resistivity before and after.

The shielding effectiveness test uses a specific gasket configuration has a cross section which is 1 inch

wide and .062 inch thick. The overall configuration is a “picture frame” that has a 24 inch inside dimension and 26 inch outside dimension. The test method follow the basic standard outlined in IEEE-STD-299 above with two changes. First, the shielded enclosure has a 24 inch square cut out on one wall with a 1 inch wide perimeter flange with a bolt hole configuration to mount the test gasket sample to. A 26 inch square aluminum cover plate is placed over, and bolted to the gasket surface and the bolts are torqued to maintain a constant gasket deflection of 10%. Second, the reference measurement is made by transmitting a signal through the open 24 inch aperture (Figure 4-4), not in free space as done in the IEEE test. This minimized the effects of the shielded room and aperture size which synthetically raises the Shielding Effectiveness. The smaller the aperture, the more the impact at lower frequencies due to the signal wave length. Shielding effectiveness is calculated by comparing the level of a signal transmitted between two antennas through the aperture to the signal level after the test gasket and cover panel are mounted in place (Figure 4-5).

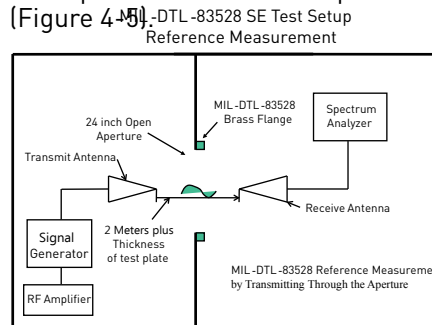

Figure 4-4

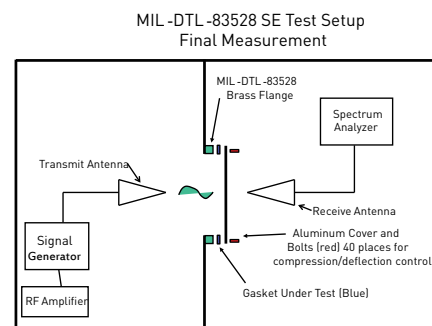

Figure 4-5

This standard was developed to allow EMI gasket manufacturers to obtain material approval and be listed on the Military Qualified Products List (QPL) for use in Military EMI design applications. Achieving the same level of shielding effectiveness in the actual application was NOT intended based on the fact that a typical gasket design is very different than the gasket used for the MIL-DTL-83528 Material qualification.

Parker Chomerics CHO-TP08 – Parker Chomerics developed this test method to provide shielding effectiveness test data on EMI gasket materials THAT WOULD CLOSELY REFLECT what a customer would get for SE in their actual application.

For this test method, Parker – Chomerics changed the items from the test setup in the MIL-DTL-83528 described above that had a significant impact on the SE performance of the EMI gasket. The intent was to create a test method with a focus on the gasket performance specifically, and remove test conditions that “synthetically” changed (improved) the test results. First, the 1 inch wide by 0.062 thick gasket was replaced with a small common EMI gasket extrusion (Figure 4-6).

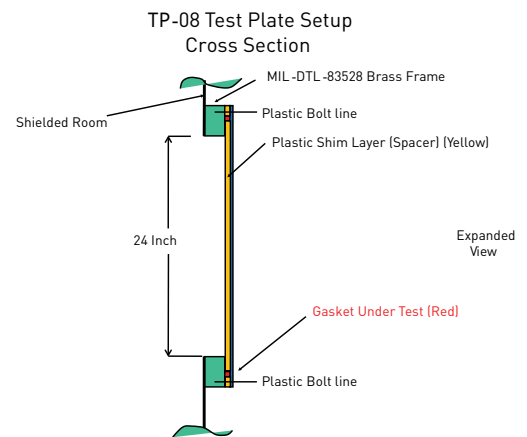

Figure 4-6

Second, the aluminum test plate was attached to a plastic layer. A groove was cut completely through the plastic layer sized for the extrusion. Test plastic layer isolated the aluminum plate from the opposing mating surface.

The plastic layer also created a compression stop to ensure a proper/uniform "nominal" deflection of the gasket. Third, the metal bolts were changed to plastic bolts to eliminate the electrical connection created by the metal bolts. In this configuration, the only electrical conductive path between the two mating surfaces is through the EMI gasket material. This maximizes the focus on the EMI gasket and not the test fixtures, bolts and any metal to metal contact between the mating surfaces like present in a typical "gasket in a groove".

As done for the MIL-DTL-83528 test, the reference measurement is made by transmitting a signal through the open 24 inch aperture (Figure 4-4), not in free space as done in the IEEE test. Shielding effectiveness is calculated by comparing the level of a signal transmitted between two antennas through the aperture to the signal level after the test gasket and cover panel are mounted in place (Figure 4-5).

Shielding effectiveness test results produced from this test method are similar to what a user would find in their own application. In many cases the SE value is lower because in the real world there are metal connections other than the gasket i.e. hinges, bolts etc. Keep in mind that there are many factors impact shielding effectiveness i.e. conversion coatings, gasket deflection, fasteners/hinges and cover deflection. Not all aspects of user configurations can be evaluated in a simple SE test.

Parker Chomerics CHO-TP09
Parker Chomerics developed this test method to provide shielding effectiveness test data on EMI gasket materials THAT ARE TESTED BEFORE AND AFTER ENVIRONMENTAL EXPOSURE.

For this test method, two plates are assembled together (Test Set) with an EMI gasket and compression stops. The Test Set is sized to allow it to be put in a typical environmental chamber. Shielding effectiveness testing is performed before and after environmental exposure. This is

typically done at durations of 336 hours, 502 hours and 1000 hours to replicate "real world conditions". Environmental exposure is typically 85/8 temperature/humidity and/or salt fog condition. Other environmental exposures and durations are all possible. The key to this test method is that the Test Sets are never disassembled during the test cycle. The gasket position, deflection and connection to the mating surfaces is not disturbed.

Below are two drawings that illustrate both the Test Set Frame (Figure 4-7) and The Test Set Cover (Figure 4-8).

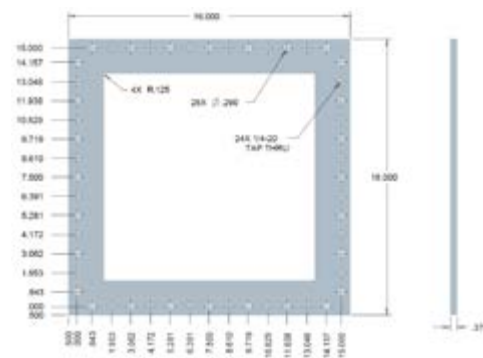

Figure 4-7. CHO-TP09 Aluminum Frame.

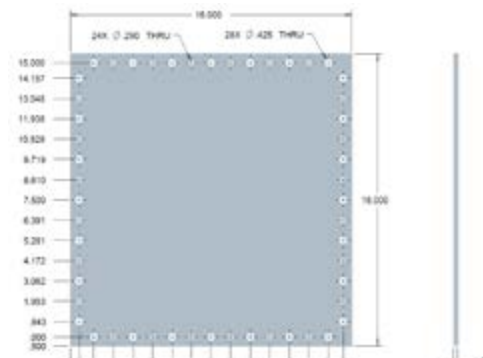

Figure 4-8. CHO-TP09 Aluminum Cover.

The plastic spacer used to separate the Set Sets and create the proper gasket deflection are either in 4 piece strip form down each side or washers around each bolt. Here again, the thickness of the compression stops is typically set for "nominal deflection" of the gasket (Figure 4-9).

Metal bolts are used in the Test Set assembly to hold it all together.

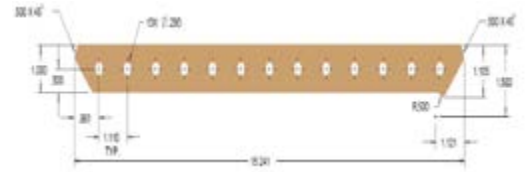

Figure 4-9 - TP09 Plastic Compression Stop

Metal bolts are used so that the fully assembled Test Set can withstand the temperature exposure and maintain the gasket position and deflection. Plastic bolts in these temperature conditions were found to break, warp and or stretch which changed the gasket position and deflection.

This test is routinely performed using test plates that have been conversion coated to MIL-DTL-5541, Type I or II, Class 3. Here again, the presents of the conversion coating replicates a real world condition.

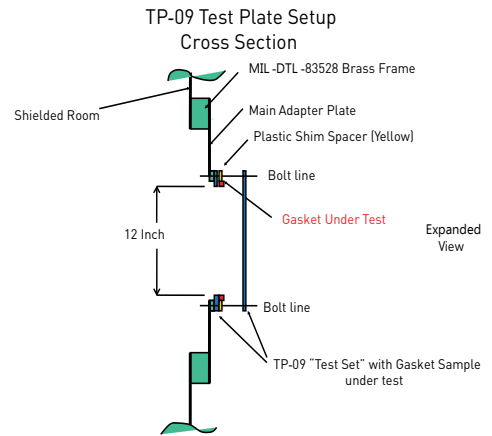

Figure 4-10

As done for the MIL-DTL-83528 and CHO-TP08 test, the reference measurement is made by transmitting a signal through the open 24 inch aperture (Figure 4-4), not in free space as done in the IEEE test. Shielding effectiveness is calculated by comparing the level of a signal transmitted between two antennas through the aperture after the test gasket and cover panel are mounted in place (Figure 4-5).

EMP Survivability

In order for an enclosure to continue providing EMI isolation during and after an EMP (Electro-Magnetic Pulse) environment, the conductive gaskets at joints and seams must be capable of carrying EMP-induced current pulses without losing their conductivity. The conductive elastomer material specification MIL-DTL-83528 contains a qualification test requirement specific for EMP survivability (Section 4.5.16).

Graph 4-12 shows the EMP current response of various types of conductive elastomer gaskets.

Note that gaskets based on silver-plated-glass fillers (CHO-SEAL 1350 and 1310) may become nonconductive at low levels of EMP current. Figure 4-11 is an electron microscope photo which clearly shows the damage mechanism where the silver plating is "blown away" at the electrical contact point between particles. This phenomena is created due to the thickness in the silver plating applied to the glass particle (sphere). Only the silver plated surface carries the EMP current since the particle has a non-conductive glass core material. Thinner plating thicknesses cannot carry the electrical current created by the EMP current pulse. The silver plating can be applied to the glass particle thick enough to carry the EMP current pulse and therefore the silver-glass material type CHO-SEAL 1350 has been included in the MIL-DTL-83528 standard (Type M). However, most manufacturers of silver glass filled

elastomer do not silver plate (control) the particles in-house and/or produce particles with an inconsistent plating thickness which will produce test result failures under EMP current pulse testing. Although Parker Chomerics does plate conductive particles in-house to control this, Parker Chomerics still does not recommend the use of silver-glass filled conductive elastomer gaskets when EMP is a design consideration.

Silver-plated-copper filled (1215) gaskets have the highest resistance to EMP type currents, showing no loss of conductivity even at 2.5 kA/inch of gasket (peak-to-peak). Pure silver (1224) and silver-plated-aluminum filled (1285) gaskets have less current carrying capability than silver-plated-copper materials, but are generally acceptable for EMP hardened systems (depending on specific EMP threat levels, gasket cross section dimensions, etc.).

Chomerics specialty materials CHO-SEAL 1298 containing silver-plated-aluminum in fluorosilicone, 6502 containing nickel-plated-aluminum in silicone and 6503 containing nickel-plated-aluminum in fluorosilicone are not listed as a material type within MIL-DTL-83528 however, these materials have been successfully tested to the EMP requirements of MIL-DTL-83528 and have maintained a post test volume resistivity of < 0.010 Ohm-cm.

EMP Survivability data for many other Chomerics "non-MIL-DTL-83528" conductive elastomer materials does exist. Contact Chomerics Applications Engineering department for further information.

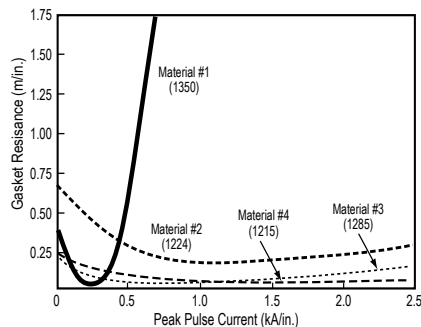

Graph 4-12. EMP Current Response of Conductive Elastomer Gaskets

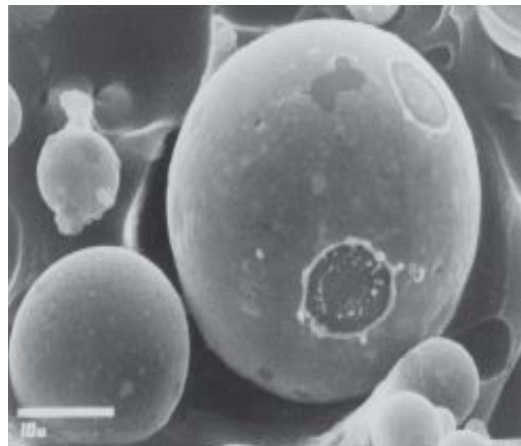

Figure 4-11. Scanning Electron Microscopy Illustrates EMP Damage Mechanism for Silver/Glass Elastomers

Vibration Resistance

Certain conductive elastomers are electrically stable during aircraft level vibration environments, while others are not.

The key factor which determines vibration resistance is the shape and surface texture of the filler particles. Smooth, spherical fillers (such as those used in silver-plated-glass materials) only make point to point contact in the elastomer matrix and tend to move apart during vibration. As described in the EMP Section above, lower quality plating processes also produce thin coatings that are easily "rubbed" away under vibration. These issues lead to a dramatic increases in resistance and loss of shielding effectiveness (although they may recover some of their initial properties in conductivity after the vibration has ended). Rough, less spherical particles resist vibration with very little electrical degradation.

Graph 4-13 shows the effects of vibration on three types of conductive gaskets. Although Chomerics silver-plated-copper, silver-plated-aluminum, nickel-plated-aluminum filled gaskets, with rough, irregular particle agglomerations, exhibits excellent stability during vibration, users of conductive elastomers should be aware that smooth, spherical silver-plated-copper or aluminum fillers can be almost as unstable as silver-plated-glass fillers.

Vibration test data for many other Chomerics "non-MIL-DTL-83528" conductive elastomer materials does exist. Contact Chomerics Applications Engineering department for further information.

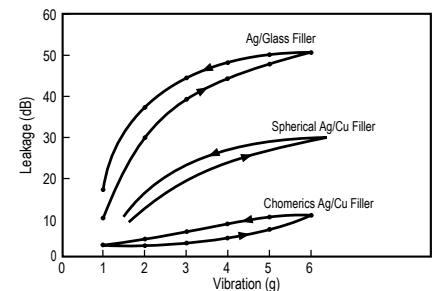

Graph 4-13. Effects of Vibration on Shielding Effectiveness of Conductive Elastomer Gaskets

Heat Aging

The primary aging mechanism which affects electrical stability of conductive elastomers is the oxidation of filler particles. For materials based on pure silver fillers, particle oxidation is not generally a problem because the oxide of silver is relatively soft and reasonably conductive. If the filler particles are non-noble (such as copper, nickel, aluminum, etc.) they will oxidize readily over time and become nonconductive. Even silver-plated base metal powders, such as silver-plated-copper or silver-plated-aluminum will become non-conductive over time if the plating is not done properly (or if other processing variables are not properly controlled). These are generally batch control problems, with each batch being potentially good or bad.

The most reliable method of predicting whether a batch will be electrically stable is to promote the rate at which poorly plated or processed particles will oxidize, by heat aging in an air circulating oven. For qualification, 1000 hours (42 days) at maximum rated use temperature (with the gasket sample deflected 7-10% between flanges) is the recommended heat aging test for accelerating the effects of long-term aging at normal ambient temperatures. A quicker heat aging test, which correlates well with the 1000 hour test and is useful for QC acceptance testing, involves a 48 hour/150°C oven bake with the gasket sample on an open wire-grid tray (rather than being clamped between flanges). Graph 4-14 shows typical data for volume resistivity versus time for each of these tests.

Note: It is essential that no source of free sulfur be placed in the aging oven, as it will cause the material to degrade electrically and mask any oxidation aging tendencies. Common sources of sulfur are neoprenes, most cardboards and other paper products.

Outgassing

Many spacecraft specifications

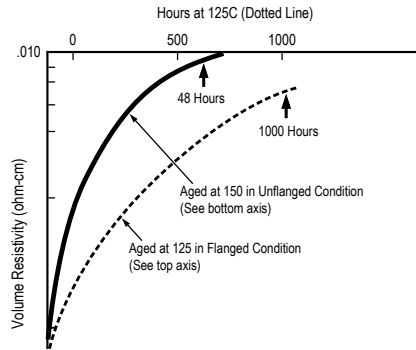

Graph 4-14. Typical heat aging characteristics of Chomerics plated-powder-filled conductive elastomers. Flanged 1000-hr test recommended for qualification. Unflanged 48-hr. test recommended for QC acceptance.

require that nonmetallic components be virtually free of volatile residues which might outgas in the hard vacuum environment of space. The standard test method for determining outgassing behavior is ASTM E595, which provides

for measurement of total mass loss (TML) and collected volatile condensable materials (CVCM) in a vacuum environment. Data for a number of Chomerics conductive elastomers, based on ASTM E595 testing done by NASA Goddard Spaceflight Center, is presented in Table 4-2. The normal specification limits or guide-lines on outgassing for NASA applications are 1% TML max., and 0.1% CVCM max.

Lightning Strike Resistance

Lightning strike testing of CHO-SEAL® 1298 material has demonstrated survivability beyond 5kA/n. The survivability of any system to lightning strike is dependent on specific flange design. For detailed information, contact Chomerics' Applications Department or request Chomerics' test Report TR34A.

Table 4-2: Outgassing Data for Conductive Elastomers

Outgassing Data for Conductive Elastomers (Per ASTM E595)				
	Special Post Curing	TML % Limit <1.0%	CVCM% Limit <0.1%	NASA GSFC Data Reference
CHO-SEAL 1215	None	0.45	0.10	15142
CHO-SEAL 1217	None	0.45	0.01	15231
CHO-SEAL 1221	None	0.35	0.02	15249
CHO-SEAL 1224	None	0.41	0.10	15211
CHO-SEAL 1285	None	0.62	0.09	15251
CHO-SEAL 1287	None	0.63	0.03	15165
CHO-SEAL 1298	None	0.12	0.02	28381
CHO-SEAL S6305	Yes	0.15	0.09	23961
CHO-SEAL 6370	Yes	0.19	0.10	23964
CHO-SEAL 6503	None	0.52	0.04	22931

CHOMERICS' CORROSION PROTECTION PUBLICATIONS

- Test Method CHO-TM100 Parker Chomerics Test Method for Assessing Galvanic Corrosion Caused Conductive Elastomers
- Test Method CHO-TM101 Parker Chomerics Test Method for Assessing Galvanic Corrosion Caused Conductive Elastomers
- Test Method CHO-TP08 Parker Chomerics Test Method for Shielding Effectiveness
- Test Method CHO-TP09 Parker Chomerics Test Procedure for S.E. Measurements of EMI Gaskets including Environmental Exposure
- Test Report CHO-TC002 Parker Chomerics Test Report for Product Evaluation: Carbon Filled TPE Elastomer Corrosion Resistance

CHO-SEAL Conductive Elastomer Materials

INTRODUCTION

CONDUCTIVE ELASTOMER SELECTION GUIDE

Tables 5-1 and 5-2 contained herein provide selection guidelines for Chomerics' most general-purpose EMI elastomer materials. With the exception of certain limitations noted under "Remarks", these materials are electrically stable over time and provide excellent moisture and pressure sealing. They are all medium-durometer materials and differ mainly in shielding performance and corrosion resistance. (Nickel-plated aluminum materials are significantly more corrosion-resistant than silver-plated copper, silver-plated aluminum, and silver-plated nickel filled materials against aluminum.)

- Availability
- Design Flexibility
- Cost Effectiveness
- Proven Performance

...just four of the reasons why conductive elastomer gaskets are so often the right EMI shielding solution!

Once used mainly to shield critical defense and aerospace electronic systems, Parker Chomerics conductive elastomers have become the progressive choice for packaging designers of consumer, telecommunications, business, industrial equipment, automotive, medical devices and much more.

Conductive elastomers are reliable over the life of the equipment. The same gasket is both an EMI shield and an environmental seal. Elastomer gaskets resist compression set, accommodate low closure force, and help control airflow. They're available in corrosion-resistant and flame-resistant grades. Their aesthetic advantages are obvious.

Almost any elastomer profile can be extruded or custom-molded with modest tooling costs and short lead times for either prototypes or large orders. Parker Chomerics can also take a customer-supplied design and deliver finished parts. Parker Chomerics offers hundreds of standard molded and extruded products. Molded products provide moisture/pressure sealing and EMI/EMP shielding when compressed properly in seals, flanges, bulkheads, and other assemblies. Extrusions provide similar benefits and are also readily lathe-cut into washers, spliced, bonded, kiss-cut, or die-cut to reduce installation labor and to conserve material, resulting in a cost-effective alternative to other methods of EMI shielding and environmental sealing.

CHO-SEAL® CONDUCTIVE ELASTOMERS

Over the years, Parker Chomerics has developed and enhanced virtually every aspect of conductive elastomer materials technology, from the earliest silver and silver-plated copper filled silicones, to the latest and more cost-effective nickel-plated aluminum and nickel-plated graphite composites. Today we offer the most comprehensive selection and highest quality products available.

Each conductive elastomer consists of a silicone, fluorosilicone, EPDM or fluorocarbon-fluorosilicone binder with a filler of pure silver, silver-plated copper, silver-plated aluminum,

silver-plated nickel, silver-plated glass, nickel-plated graphite, nickel-plated aluminum or unplated graphite particles. The development of these composites is the result of decades of research and testing, both in the laboratory and in the field. Our proprietary filler powder technology allows us to carefully control the composition, size, and morphology of the conductive particles. Their precise, uniform dispersion within the resinous binders produces materials with stable and consistent electrical and physical properties.

Parker Chomerics' conductive elastomers feature excellent resistance to compression set over a wide temperature range, resulting in years of continuous service. In addition to EMI shielding, these materials can provide an environmental or pressure seal if required.

For those materials containing silver, both packaging and storage conditions should be similar to those for other silver-containing components, such as relays or switches. They should be stored in sheet plastic, such as polyester or polyethylene, and kept away from sulfur-containing materials, such as sulfur-cured neoprene, cardboard, etc. To remove dirt, clean the elastomer with water or alcohol containing mild soap (do not use aromatic or chlorinated solvents).

Shelf life of conductive elastomers without pressure sensitive adhesive (PSA) is indefinite, with PSA is 12 months from date of manufacture. Refer to page 30 for Applications detailed guidance on PSA systems.

Tables 5-3 and 5-4 outline the properties and specification limits of Parker Chomerics' conductive elastomers. These materials are produced in a virtually unlimited variety of molded, die-cut and extruded shapes and sizes. Our Applications Engineering Department is very accessible, and ready to assist with material selection and gasket design. We welcome your inquiry.

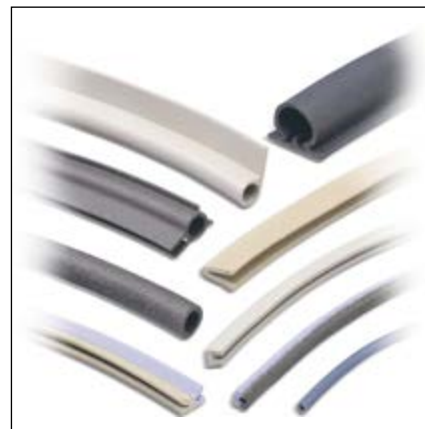

MATERIAL SELECTION

The Parker Chomerics array of conductive elastomers offers true flexibility in selecting the appropriate material for a specific application on the basis of cost and level of attenuation required. Price varies directly with shielding performance.

For some military/aerospace applications, users of conductive elastomer gaskets consider specifying materials that meet MIL-DTL-83528 where appropriate but note that newer materials may not yet be included in that specification, e.g., nickel-plated aluminum filled elastomers. To avoid the risk of system EMI or environmental seal failure, any change in conductive elastomer seal supplier (including MIL DTL- 83528 QPL suppliers) should be preceded by thorough system qualification testing.

UL 94 V-0 RATED MATERIALS

Parker Chomerics selection of UL 94 V-0 rated gasket materials includes CHO-SEAL 6370, 6371, 1273, S6305 and 1310.

CHO-SEAL gasket materials are rated at UL 94 V-0 down to a thickness of 0.013 Inch (0.33 mm). Actual thickness for each certified material, and specific conditions of use can be found in UL File #OCDT2.E140244 under Insulating Devices and Materials – Components. CHO-SEAL materials certified by UL for use in Canada can be found in UL File OCDT8.E140244. For UL Certification files, please visit www.ul.com.

Conductive Elastomer Applications

In general, certain types of Parker’s conductive elastomers are specified more often for military/ aerospace applications or for commercial applications. However, there is a considerable overlap, and our Applications Engineering department will be pleased to assist you with your product selection.





Parker Chomerics Trade Names

CHO-SEAL	METALKLIP
CHOFORM & ParPHorm	POLASHEET
CHOFOAM	POLASTRIP
CHO-BOND	PREMIER
CHO-SHIELD	SHIELDMESH
COMBO STRIP	SOFT-SHIELD
ECOPLATE	SPRINGMESH
MESH STRIP	SPRING-LINE

ELASTOMER PRODUCT OFFERING

	Material	Binder	Configuration
Military and Commercial	CHO-SEAL 6502	Silicone	Molded and Extruded
	CHO-SEAL 6503	Fluorosilicone	
	CHO-SEAL 1298	Fluorosilicone	
	CHO-SEAL 1285	Silicone	
	CHO-SEAL 1287	Fluorosilicone	
	CHO-SEAL 1215	Silicone	
	CHO-SEAL 1217	Fluorosilicone	
	CHO-SEAL S6305	Silicone	
	CHO-SEAL 6370	Silicone	Extruded
	CHO-SEAL 6371	Silicone	Molded
	CHO-SEAL 6308	Silicone	Extruded
	CHO-SEAL 6330	Silicone	Sheets Only
	CHO-SEAL L6303	Fluorosilicone	Molded and Extruded
	CHO-SEAL 1350	Silicone	Molded
	CHO-SEAL 1310	Silicone	
CHO-SEAL 1273	Silicone	Molded and Extruded	
CHO-SEAL 1270	Silicone	Molded	
CHO-SEAL 1224	Silicone		
CHO-SEAL 1221	Fluorosilicone	Molded and Extruded	
CHO-SEAL 1401	Silicone		
CHO-SEAL 1239	Silicone/Cu Mesh		
CHO-SEAL 1212	Silicone		
Specialty	CHO-SEAL 6435	EPDM	Molded
	CHO-SEAL 6307	EPDM	
	CHO-SEAL 6452	EPDM	
	CHO-SEAL 6460	EPDM	Extruded
	CHO-SEAL V6433	Fluoro/Fluorocarbon	Molded
	CHO-SEAL S6600	Silicone	

ELASTOMERS

Elastomer Binder Legend			
Silicone	Fluorosilicone	EPDM	Fluorocarbon/ Fluorosilicone
			







Shielding and Corrosion Performance					
Fair	Good	Very Good	Excellent		
					

Table 5-1: Quick Reference Guide for Selecting Conductive Elastomers - Typical Commercial and Military Applications
(M) = Molded only, (E) = Extruded only

Material	Filler	Binder	Shielding	Corrosion (on Aluminum)	MIL-DTL-83528
CHO-SEAL 6502	Nickel-Aluminum	Silicone	○○○○○○	○○○○○○	-----
CHO-SEAL 6503	Nickel-Aluminum	Fluorosilicone	○○○○○○	○○○○○○	-----
CHO-SEAL 1298	Silver-Aluminum	Fluorosilicone	○○○	○○○○	Type D
CHO-SEAL 1285	Silver-Aluminum	Silicone	○○○○○	○○○	Type B
CHO-SEAL 1287	Silver-Aluminum	Fluorosilicone	○○○	○○○	Type D
CHO-SEAL 1215	Silver-Copper	Silicone	○○○○○○	○	Type A
CHO-SEAL 1217	Silver-Copper	Fluorosilicone	○○○○○○	○	Type C
CHO-SEAL S6305	Nickel-Graphite	Silicone	○○○	○○	-----
CHO-SEAL 6370 ^(E)	Nickel-Graphite	Silicone	○○	○○	-----
CHO-SEAL 6371 ^(M)	Nickel-Graphite	Silicone	○○	○○	-----
CHO-SEAL 6308 ^(E)	Nickel-Graphite	Silicone	○○○	○○	-----
CHO-SEAL 6330 ^(M)	Nickel-Graphite	Silicone	○	○○	-----
CHO-SEAL L6303	Nickel-Graphite	Fluorosilicone	○○○	○○	-----
CHO-SEAL 1350	Silver-Glass	Silicone	○○○○○	○	Type M*
CHO-SEAL 1310 ^(M)	Silver-Glass	Silicone	○○○	○	-----
CHO-SEAL 1273	Silver-Copper	Silicone	○○○○○	○	-----
CHO-SEAL 1270** ^(M)	Silver-Copper	Silicone	○	○	-----

* Molded version of 1350 meets Mil-DTL-83528 type M specifications. Extruded version of 1350 meets Mil-DTL-83528 type M specifications except elongation (60/260).

**Limited availability

Table 5-2: Quick Reference Guide for Selecting Conductive Elastomers - Specialty Elastomers
(M) = Molded only, (E) = Extruded only

Material	Filler	Binder	Shielding	Corrosion (on Aluminum)	MIL-DTL-83528
CHO-SEAL 1224 ^(M)	Silver	Silicone	○○○○○○○○	○	Type E
CHO-SEAL 1221 ^(M)	Silver	Fluorosilicone	○○○○○○○○	○	Type F
CHO-SEAL 1401	Silver	Silicone	○○○○○	○	-----
CHO-SEAL 1239 ^(M)	Silver-Copper	Silicone/Cu Mesh	○○○○○	○	Type G
CHO-SEAL 1212 ^(M)	Silver-Copper	Silicone	○○○○○○	○	Type K
CHO-SEAL 6435 ^(M)	Silver-Nickel	EPDM	○○○	○○○	-----
CHO-SEAL 6307 ^(M)	Nickel-Graphite	EPDM	○○	○○○	-----
CHO-SEAL 6452 ^(E)	Nickel-Graphite	EPDM	○○○	○○○○	-----
CHO-SEAL 6460 ^(M)	Nickel-Aluminum	EPDM	○○○○○	○○○○○○	-----
CHO-SEAL V6433 ^(M)	Silver-Nickel	Fluoro/Fluorocarbon	○○○	○○○	-----
CHO-SEAL S6600 ^(M)	Carbon	Silicone	○	○	-----

Elastomer Binder Legend



Elastomer Filler Legend

Corrosion Resistant on Aluminum



Table 5-3: Material Guidelines - Military and Commercial

		Test Procedure (Type of Test)	CHO-SEAL 6502	CHO-SEAL 6503	CHO-SEAL 1298	CHO-SEAL 1285	CHO-SEAL 1287	CHO-SEAL 1215	
Physical	Molded (M) or Extruded (E)	--	M/E	M/E	M/E	M/E	M/E	M/E	
	Conductive Filler	--	Ni/Al	Ni/Al	Passivated Ag/Al	Ag/Al	Ag/Al	Ag/Cu	
	Elastomer Binder	--	Silicone	Fluorosilicone	Fluorosilicone	Silicone	Fluorosilicone	Silicone	
	Type (Ref. MIL-DTL-83528)	--	Not Applicable	Not Applicable	Type D	Type B	Type D	Type A	
	Volume Resistivity, ohm-cm, max., as supplied without pressure sensitive adhesive	CEPS-0002 ^c (Q/C)	0.150	0.250	Not Applicable	Not Applicable	Not Applicable	Not Applicable	Not Applicable
		MIL-DTL-83528 (Q/C)	Not Applicable	Not Applicable	0.012	0.008	0.012	0.004	
	Hardness, Shore A	ASTM D2240 (Q/C)	68 ±10	72 ±10	70 ±7	65 ±7	70 ±7	65 ±7	
	Specific Gravity	ASTM D792 (Q/C)	1.85 ± 0.25	2.05 ± 0.25	2.00 ± 0.25	2.00 ± 0.25	2.00 ± 0.25	3.50 ±0.45	
	Tensile Strength, psi (MPa), min.	ASTM D412 (Q/C)	150 (1.03)	150 (1.03)	180 (1.24)	200 (1.38)	180 (1.24)	200 (1.38)	
	Elongation, % min. or % min./max.	ASTM D412 (Q/C)	100 min	50 min	60/260	100/300	60/260	100/300	
	Tear Strength, lb/in. (kN/m), min.	ASTM D624 (Q)	40 (7.00)	35 (6.13)	35 (6.13)	30 (5.25)	35 (6.13)	40 (7.00) / 25 (4.38)	
	Compression Set, 70 hrs at 100°C, % max. ^(A)	ASTM D395, Method B (Q)	30	30	30	32	30	32	
Thermal	Low Temperature Flex TR10, °C, min.	ASTM D1329 (Q)	-55	-55	-55	-65	-55	-65	
	Maximum Continuous Use Temperature, °C ^(B)	--	125	125	160/200	160/200	160/200	125	
	Thermal Conductivity, W/m-K (Typical) 300 psi (2.07 MPa)	ASTM D5470	1.0	0.9	1.2	2.2	Not Tested	2.1	
Electrical	Shielding Effectiveness, dB, min. ^(F)	Method 1: CHO-TP08 ^c (Q)	Method 2	Method 2	Method 2	Method 2	Method 2	Method 2	
			200 kHz (H Field)	Not Tested	Not Tested	55	60	55	70
		100 MHz (E Field)	127	127	110	115	110	120	
		Method 2: MIL-DTL-83528 Para. 4.5.12 (Q)	500 MHz (E Field)	115	117	100	110	100	120
			2 GHz (Plane Wave)	116	116	95	105	95	120
		10 GHz (Plane Wave)	127	127	90	100	90	120	
	Method 3: CHO-TP09 ^c (Q)	Not Tested		75	Not Tested	75	90		
	Electrical Stability, ohm-cm, max.	Heat Aging	CEPS-0002 ^c (Q)	0.200 ^(H)	0.250 ^(H)	Not Applicable	Not Applicable	Not Applicable	Not Applicable
			MIL-DTL-83528 Para. 4.5.15 (Q/C)	Not Applicable	Not Applicable	0.015	0.010	0.015	0.010
		Resistance During Vibration	MIL-DTL-83528 Para. 4.5.13 (Q)	Not Applicable	Not Applicable	0.015	0.012	0.015	0.004
Resistance After Vibration		MIL-DTL-83528 Para. 4.5.13 (Q)	Not Applicable	Not Applicable	0.012	0.008	0.012	0.008	
Post Tensile Set Volume Resistivity	MIL-DTL-83528 Para. 4.5.9 (Q/C)	Not Applicable	Not Applicable	0.015	0.015	0.015	0.008		
Regulatory	EMP Survivability, kA per in. perimeter	MIL-DTL-83528 Para. 4.5.16 (Q)	>0.9	>0.9	>0.9	>0.9	>0.9	>0.9	
	RoHS Compliant	--	Yes	Yes	Yes	Yes	Yes	Yes	
	UL 94 Flammability Rating	UL 94	Not Tested	Not Tested	Not Tested	Not Tested	Not Tested	Not Tested	

Note A: Compression set is expressed as a percentage of deflection per ASTM D395 Method B, at 25% deflection. To determine percent recovery, subtract 0.25 of the stated compression set value from 100%. For example, in the case of 30% compression set, recovery is 92.5%.

Note B: Where two values are shown, the first represents max. operating temp. for conformance to MIL-DTL-83528 (which requires Group A life testing at 1.25 times max. operating temp.) and the second value represents the practical limit for exposure up to 1000 hrs. (compressed between flanges 7-10%). Single values conform to both definitions.

Note C: Copies of CEPS-0002, CHO-TP08 and CHO-TP09 are available from Chomerics. Contact Applications Engineering.

Note D: Heat aging condition: 100°C for 48 hrs.

Note E: Heat aging condition: 150°C for 48 hrs.

Note F: It may not be inferred that the same level of shielding effectiveness provided by a gasket material tested in the fixture per MIL-DTL-83528 Para. 4.5.12 would be provided in an actual equipment flange, since many mechanical factors of the flange design (tolerances, stiffness, fastener location and size, etc.) could lower or enhance shielding effectiveness. This procedure provides data applicable only to the test fixture design of MIL-DTL-83528, but which is useful for making comparisons between different gasket materials. The 40 GHz test data for all materials uses TP08 test method.

Note G: Heat aging condition: 200 °C for 48 hours

Note H: Heat aging condition: 125 °C for 1000 hours

continued on next page...

ELASTOMERS

Elastomer Binder Legend

Silicone



Fluorosilicone



EPDM

Fluorocarbon/
Fluorosilicone

Elastomer Filler Legend

Corrosion Resistant on Aluminum



continued...Table 5-3: Material Guidelines - Military and Commercial - continued

		Test Procedure (Type of Test)	CHO-SEAL 1217	CHO-SEAL S6305	CHO-SEAL 6370	CHO-SEAL 6371	CHO-SEAL 6308	
Physical	Molded (M) or Extruded (E)	--	M/E	M/E	E	M	E	
	Conductive Filler	--	Ag/Cu	Ni/C	Ni/C	Ni/C	Ni/C	
	Elastomer Binder	--	Fluorosilicone	Silicone	Silicone	Silicone	Silicone	
	Type (Ref. MIL-DTL-83528)	--	Type C	Not Applicable	Not Applicable	Not Applicable	Not Applicable	
	Volume Resistivity, ohm-cm, max., as supplied without pressure sensitive adhesive	CEPS-0002 ^c (Q/C)	Not Applicable	0.100	0.100	0.100	0.100	
		MIL-DTL-83528 (Q/C)	0.010	Not Applicable	Not Applicable	Not Applicable	Not Applicable	
	Hardness, Shore A	ASTM D2240 (Q/C)	75 ±7	65 ±10	60 ±10	65 ±10	65 ±10	
	Specific Gravity	ASTM D792 (Q/C)	4.00 ± 0.50	2.00 ± 0.25	2.10 ± 0.25	2.00 ± 0.25	2.00 ± 0.25	
	Tensile Strength, psi (MPa), min.	ASTM D412 (Q/C)	180 (1.24)	200 (1.38)	150 (1.03)	150 (1.03)	200 (1.38)	
	Elongation, % min. or % min./max.	ASTM D412 (Q/C)	100/300	100	100	100	75	
	Tear Strength, lb/in. (kN/m), min.	ASTM D624 (Q)	35 (6.13)	50 (8.75)	35 (6.13)	Not Tested	40 (7.00)	
	Compression Set, 70 hrs at 100°C, % max. ^(A)	ASTM D395, Method B (Q)	35	30	40	40	30	
Thermal	Low Temperature Flex TR10, °C, min.	ASTM D1329 (Q)	-55	-45	-45	-40	-60	
	Maximum Continuous Use Temperature, °C ^(B)	--	125	150	150	150	150	
	Thermal Conductivity, W/m-K (Typical) 300 psi (2.07 MPa)	ASTM D5470	Not Tested	0.8	0.9	1.1	Not Tested	
Electrical	Shielding Effectiveness, dB, min. ^(F)	Method 1: CHO-TP08 ^c (Q)	Method 2	Method 1	Method 1	Method 1	Method 1	
			200 kHz (H Field)	70	Not Tested	Not Tested	Not Tested	Not Tested
		100 MHz (E Field)	120	100	100	100	100	
		500 MHz (E Field)	120	100	100	100	100	
		2 GHz (Plane Wave)	115	100	95	80	100	
		10 GHz (Plane Wave)	110	100	95	80	100	
		40 GHz (Plane Wave)	Method 3: CHO-TP09 ^c (Q)	Not Tested	75	Not Tested	Not Tested	Not Tested
	Electrical Stability, ohm-cm, max.	Heat Aging	CEPS-0002 ^c (Q)	Not Applicable	0.250 ^e	0.250 ^(e)	0.250 ^(e)	0.250 ^e
			MIL-DTL-83528 Para. 4.5.15 (Q/C)	0.015	Not Applicable	Not Applicable	Not Applicable	Not Applicable
		Resistance During Vibration	MIL-DTL-83528 Para. 4.5.13 (Q)	0.010	Not Applicable	Not Applicable	Not Applicable	Not Applicable
Resistance After Vibration		MIL-DTL-83528 Para. 4.5.13 (Q)	0.015	Not Applicable	Not Applicable	Not Applicable	Not Applicable	
Post Tensile Set Volume Resistivity		MIL-DTL-83528 Para. 4.5.9 (Q/C)	0.015	Not Applicable	Not Applicable	Not Applicable	Not Applicable	
Regulatory	EMP Survivability, kA per in. perimeter	MIL-DTL-83528 Para. 4.5.16 (Q)	>0.9	Not Applicable	Not Applicable	Not Applicable	Not Applicable	
	RoHS Compliant	--	Yes	Yes	Yes	Yes	Yes	
	UL 94 Flammability Rating	UL 94	Not Tested	V-0	V-0	V-0	Not Tested	

Note A: Compression set is expressed as a percentage of deflection per ASTM D395 Method B, at 25% deflection. To determine percent recovery, subtract 0.25 of the stated compression set value from 100%. For example, in the case of 30% compression set, recovery is 92.5%.

Note B: Where two values are shown, the first represents max. operating temp. for conformance to MIL-DTL-83528 (which requires Group A life testing at 1.25 times max. operating temp.) and the second value represents the practical limit for exposure up to 1000 hrs. (compressed between flanges 7-10%). Single values conform to both definitions.

Note C: Copies of CEPS-0002, CHO-TP08 and CHO-TP09 are available from Chomerics. Contact Applications Engineering.

Note D: Heat aging condition: 100°C for 48 hrs.





Note E: Heat aging condition: 150°C for 48 hrs.

Note F: It may not be inferred that the same level of shielding effectiveness provided by a gasket material tested in the fixture per MIL-DTL-83528 Para. 4.5.12 would be provided in an actual equipment flange, since many mechanical factors of the flange design (tolerances, stiffness, fastener location and size, etc.) could lower or enhance shielding effectiveness. This procedure provides data applicable only to the test fixture design of MIL-DTL-83528, but which is useful for making comparisons between different gasket materials. The 40 GHz test data for all materials uses TP08 test method.

Note G: Heat aging condition: 200 °C for 48 hours

Note H: Heat aging condition: 125 °C for 1000 hours

continued on next page...

Elastomer Binder Legend			
Silicone	Fluorosilicone	EPDM	Fluorocarbon/ Fluorosilicone
			

Elastomer Filler Legend
Corrosion Resistant on Aluminum

continued...Table 5-3: Material Guidelines - Military and Commercial - continued

		Test Procedure (Type of Test)	CHO-SEAL 6330	CHO-SEAL L6303	CHO-SEAL 1350	CHO-SEAL 1310	CHO-SEAL 1273	
Physical	Molded (M) or Extruded (E)	--	Sheets Only	M/E	M/E ^(J)	M	M/E	
	Conductive Filler	--	Ni/C	Ni/C	Ag/Glass	Ag/Glass	Ag/Cu	
	Elastomer Binder	--	Silicone	Fluorosilicone	Silicone	Silicone	Silicone	
	Type (Ref. MIL-DTL-83528)	--	Not Applicable	Not Applicable	Type M ^(J)	Not Applicable	Not Applicable	
	Volume Resistivity, ohm-cm, max., as supplied without pressure sensitive adhesive	CEPS-0002 ^c (Q/C)	0.250	0.100	Not Applicable	0.010	0.004	
		MIL-DTL-83528 (Q/C)	Not Applicable	Not Applicable	0.006	Not Applicable	Not Applicable	
	Hardness, Shore A	ASTM D2240 (Q/C)	40 ±7	65 ±10	65 ±7	70 ±10	65 ±8	
	Specific Gravity	ASTM D792 (Q/C)	1.70 ± 0.25	2.20 ± 0.25	1.90 ± 0.25	1.80 ± 0.25	3.70 ± 0.25	
	Tensile Strength, psi (MPa), min.	ASTM D412 (Q/C)	120 (0.83)	150 (1.03)	200 (1.38)	200 (1.38)	175 (1.21)	
	Elongation, % min. or % min./max.	ASTM D412 (Q/C)	75	60	100/300	100	75	
	Tear Strength, lb/in. (kN/m), min.	ASTM D624 (Q)	Not Tested	35 (6.13)	30 (5.25)	Not Tested	Not Tested	
Compression Set, 70 hrs at 100°C, % max. ^(A)	ASTM D395, Method B (Q)	25	25	30	35	32		
Thermal	Low Temperature Flex TR10, °C, min.	ASTM D1329 (Q)	-40	-45	-55	-40	-65	
	Maximum Continuous Use Temperature, °C ^(B)	--	150	150	160	160	125	
	Thermal Conductivity, W/m-K (Typical) 300 psi (2.07 MPa)	ASTM D5470	0.6	0.8	1.2	Not Tested	Not Tested	
Electrical	Shielding Effectiveness, dB, min. ^(F)	Method 1: CHO-TP08 ^c (Q)	Method 3	Method 1	Method 2	Method 1	Method 1	
			200 kHz (H Field)	Not Tested	Not Tested	50	Not Tested	Not Tested
		100 MHz (E Field)	Method 2: MIL-DTL-83528 Para. 4.5.12 (Q)	75	100	125	100	100
		500 MHz (E Field)		75	100	114	100	100
		2 GHz (Plane Wave)		70	100	116	90	100
		10 GHz (Plane Wave)		70	100	124	80	100
		40 GHz (Plane Wave)	Method 3: CHO-TP09 ^c (Q)	Not Tested	Not Tested	Not Tested	Not Tested	Not Tested
	Electrical Stability, ohm-cm, max.	Heat Aging	CEPS-0002 ^c (Q)	0.250 ^(e)	0.250 ^e	Not Applicable	0.010	0.010
			MIL-DTL-83528 Para. 4.5.15 (Q/C)	Not Applicable	Not Applicable	0.015	Not Applicable	Not Applicable
		Resistance During Vibration	MIL-DTL-83528 Para. 4.5.13 (Q)	Not Applicable	Not Applicable	0.009	Not Applicable	Not Applicable
		Resistance After Vibration	MIL-DTL-83528 Para. 4.5.13 (Q)	Not Applicable	Not Applicable	0.006	Not Applicable	Not Applicable
Post Tensile Set Volume Resistivity	MIL-DTL-83528 Para. 4.5.9 (Q/C)	Not Applicable	Not Applicable	0.009	Not Applicable	Not Applicable		
Regulatory	EMP Survivability, kA per in. perimeter	MIL-DTL-83528 Para. 4.5.16 (Q)	Not Applicable	Not Applicable	>0.9	Not Applicable	Not Applicable	
	RoHS Compliant	--	Yes	Yes	Yes	Yes	Yes	
	UL 94 Flammability Rating	UL 94	Not Tested	Not Tested	Not Tested	V-0	V-0	

Note A: Compression set is expressed as a percentage of deflection per ASTM D395 Method B, at 25% deflection. To determine percent recovery, subtract 0.25 of the stated compression set value from 100%. For example, in the case of 30% compression set, recovery is 92.5%.

Note B: Where two values are shown, the first represents max. operating temp. for conformance to MIL-DTL-83528 (which requires Group A life testing at 1.25 times max. operating temp.) and the second value represents the practical limit for exposure up to 1000 hrs. (compressed between flanges 7-10%). Single values conform to both definitions.

Note C: Copies of CEPS-0002, CHO-TP08 and CHO-TP09 are available from Chomerics. Contact Applications Engineering.

Note D: Heat aging condition: 100°C for 48 hrs.

Note E: Heat aging condition: 150°C for 48 hrs.

Note F: It may not be inferred that the same level of shielding effectiveness provided by a gasket material tested in the fixture per MIL-DTL-83528 Para. 4.5.12 would be provided in an actual equipment flange, since many mechanical factors of the flange design (tolerances, stiffness, fastener

location and size, etc.) could lower or enhance shielding effectiveness. This procedure provides data applicable only to the test fixture design of MIL-DTL-83528, but which is useful for making comparisons between different gasket materials. The 40 GHz test data for all materials uses TP08 test method.





Note G: Heat aging condition: 200 °C for 48 hours

Note H: Heat aging condition: 125 °C for 1000 hours

Note J: Molded version of 1350 meets Mil-DTL-83528 type M specifications.

Extruded version of 1350 meets Mil-DTL-83528 type M specifications except elongation (60/260).

continued on next page...

Elastomer Binder Legend			
Silicone	Fluorosilicone	EPDM	Fluorocarbon/ Fluorosilicone
			

Elastomer Filler Legend
Corrosion Resistant on Aluminum

continued... Table 5-3: Material Guidelines - Military and Commercial - *continued*

		Test Procedure (Type of Test)	CHO-SEAL 1270	CHO-SEAL 1224	CHO-SEAL 1221	CHO-SEAL 1401	CHO-SEAL 1239	
Physical	Molded (M) or Extruded (E)	--	M	M	M	M/E	M	
	Conductive Filler	--	Ag/Cu	Ag	Ag	Ag	Ag/Cu	
	Elastomer Binder	--	Silicone	Silicone	Fluorosilicone	Silicone	Silicone & Expanded Cu Foil	
	Type (Ref. MIL-DTL-83528)	--	Not Applicable	Type E	Type F	Not Applicable	Type G	
	Volume Resistivity, ohm-cm, max., as supplied without pressure sensitive adhesive	CEPS-0002 ^c (Q/C)	0.050	Not Applicable	Not Applicable	Not Applicable	Not Applicable	Not Applicable
		MIL-DTL-83528 (Q/C)	Not Applicable	0.002	0.002	0.010	0.007	
	Hardness, Shore A	ASTM D2240 (Q/C)	40 ±7	65 ±7	75 ±7	45 ±5	80 ±7	
	Specific Gravity	ASTM D792 (Q/C)	2.90 ± 0.25	3.50 ±0.45	4.00 ±0.50	1.60 ± 0.25	4.75 ± 0.75	
	Tensile Strength, psi (MPa), min.	ASTM D412 (Q/C)	80 (0.55)	300 (2.07)	250 (1.72)	200 (1.38)	600 (4.14)	
	Elongation, % min. or % min./max.	ASTM D412 (Q/C)	75	200/500	100/300	75	20	
	Tear Strength, lb/in. (kN/m), min.	ASTM D624 (Q)	Not Tested	50 (8.75)	40 (7.00)	20 (3.50)	70 (12.25)	
Compression Set, 70 hrs at 100°C, % max. ^(A)	ASTM D395, Method B (Q)	30	45	60	35	Not Tested		
Thermal	Low Temperature Flex TR10, °C, min.	ASTM D1329 (Q)	-60	-65	-65	-55	Not Tested	
	Maximum Continuous Use Temperature, °C ^(B)	--	125	160/200	160/200	160/200	125	
	Thermal Conductivity, W/m-K (Typical) 300 psi (2.07 MPa)	ASTM D5470	0.8	2.8	Not Tested	0.9	1.9	
Electrical	Shielding Effectiveness, dB, min. ^(F)	Method 1: CHO-TP08 ^c (Q)	Method 3	Method 2	Method 2	Method 2	Method 2	
			200 kHz (H Field)	Not Tested	70	70	60	70
			100 MHz (E Field)	80	120	120	100	110
			500 MHz (E Field)	80	120	120	100	110
			2 GHz (Plane Wave)	70	120	120	90	110
			10 GHz (Plane Wave)	70	120	120	80	110
			40 GHz (Plane Wave)	Not Tested	Not Tested	Not Tested	Not Tested	Not Tested
	Electrical Stability, ohm-cm, max.	Heat Aging	CEPS-0002 ^c (Q)	0.100 ^e	Not Applicable	Not Applicable	Not Applicable	Not Applicable
			MIL-DTL-83528 Para. 4.5.15 (Q/C)	Not Applicable	0.010	0.010	0.015	0.010
		Resistance During Vibration	MIL-DTL-83528 Para. 4.5.13 (Q)	Not Applicable	0.010	0.010	0.015	0.007
Resistance After Vibration		MIL-DTL-83528 Para. 4.5.13 (Q)	Not Applicable	0.002	0.002	0.010	Not Applicable	
Post Tensile Set Volume Resistivity	MIL-DTL-83528 Para. 4.5.9 (Q/C)	Not Applicable	0.010	0.010	0.020	Not Applicable		
Regulatory	EMP Survivability, kA per in. perimeter	MIL-DTL-83528 Para. 4.5.16 (Q)	Not Applicable	>0.9	>0.9	>0.9	>0.9	
	RoHS Compliant	--	Yes	Yes	Yes	Yes	Yes	
	UL 94 Flammability Rating	UL 94	Not Tested	Not Tested	Not Tested	Not Tested	Not Tested	

* Molded only

Note A: Compression set is expressed as a percentage of deflection per ASTM D395 Method B, at 25% deflection. To determine percent recovery, subtract 0.25 of the stated compression set value from 100%. For example, in the case of 30% compression set, recovery is 92.5%.

Note B: Where two values are shown, the first represents max. operating temp. for conformance to MIL-DTL-83528 (which requires Group A life testing at 1.25 times max. operating temp.) and the second value represents the practical limit for exposure up to 1000 hrs. (compressed between flanges 7-10%). Single values conform to both definitions.

Note C: Copies of CEPS-0002, CHO-TP08 and CHO-TP09 are available from Chomerics. Contact Applications Engineering.

Note D: Heat aging condition: 100°C for 48 hrs.

Note E: Heat aging condition: 150°C for 48 hrs.

Note F: It may not be inferred that the same level of shielding effectiveness provided by a gasket material tested in the fixture per MIL-DTL-83528 Para. 4.5.12 would be provided in an actual equipment flange, since many mechanical factors of the flange design (tolerances, stiffness, fastener location and size, etc.) could lower or enhance shielding effectiveness. This procedure provides data applicable only to the test fixture design of MIL-DTL-83528, but which is useful for making comparisons between different gasket materials. The 40 GHz test data for all materials uses TP08 test method.

Note G: Heat aging condition: 200 °C for 48 hours

Note H: Heat aging condition: 125 °C for 1000 hours

continued on next page...

Elastomer Binder Legend

Silicone	Fluorosilicone	EPDM	Fluorocarbon/ Fluorosilicone
			

Elastomer Filler Legend

Corrosion Resistant on Aluminum

continued... Table 5-3: Material Guidelines - Military and Commercial - continued

		Test Procedure (Type of Test)	CHO-SEAL 1212	CHO-SEAL 6435	CHO-SEAL 6307	CHO-SEAL 6452	CHO-SEAL 6460	
Physical	Molded (M) or Extruded (E)	--	M	M	M	E	M	
	Conductive Filler	--	Ag/Cu	Ag/Ni	Ni/C	Ni/C	Ni/Al+Ni/C	
	Elastomer Binder	--	Silicone	EPDM	EPDM	EPDM	EPDM	
	Type (Ref. MIL-DTL-83528)	--	Type K	Not Applicable	Not Applicable	Not Applicable	Not Applicable	
	Volume Resistivity, ohm-cm, max., as supplied without pressure sensitive adhesive	CEPS-0002 ^c (Q/C)	Not Applicable	0.006	5.000	Not Applicable	Not Applicable	
		MIL-DTL-83528 (Q/C)	0.005	Not Applicable	Not Applicable	0.500	0.600	
	Hardness, Shore A	ASTM D2240 (Q/C)	85 ±7	80 ±7	75 ±7	70 ±10	65 ±7	
	Specific Gravity	ASTM D792 (Q/C)	3.50 ± 0.45	3.70 ± 0.25	1.90 ± 0.25	1.95 ± 0.25	1.80 ± 0.25	
	Tensile Strength, psi (MPa), min.	ASTM D412 (Q/C)	400 [2.76]	200 [1.38]	200 [1.38]	200 [1.38]	200 [1.38]	
	Elongation, % min. or % min./max.	ASTM D412 (Q/C)	100/300	200	75	200	200	
	Tear Strength, lb/in. (kN/m), min.	ASTM D624 (Q)	40 (7.00)	75 (13.13)	60 (10.51)	55 (9.63)	50 (8.75)	
Compression Set, 70 hrs at 100°C, % max. ^(A)	ASTM D395, Method B (Q)	35	40	40	35	30		
Thermal	Low Temperature Flex TR10, °C, min.	ASTM D1329 (Q)	-45	-40	-45	-50	-50	
	Maximum Continuous Use Temperature, °C ^(B)	--	125	100	100	100	100	
	Thermal Conductivity, W/m-K (Typical) 300 psi (2.07 MPa)	ASTM D5470	1.8	1.8	0.6	Not Tested	Not Tested	
Electrical	Shielding Effectiveness, dB, min. ^(F)	Method 1: CHO-TP08 ^c (Q)	Method 2	Method 2	Method 2	Method 3	Method 2	
			200 kHz (H Field)	70	Not Tested	Not Tested	Not Tested	Not Tested
			100 MHz (E Field)	120	105	95	75	110
			500 MHz (E Field)	120	100	90	100	120
			2 GHz (Plane Wave)	120	85	85	105	105
			10 GHz (Plane Wave)	120	85	85	85	100
			40 GHz (Plane Wave)	Not Tested	Not Tested	Not Tested	Not Tested	Not Tested
	Electrical Stability, ohm-cm, max.	Heat Aging	CEPS-0002 ^c (Q)	Not Applicable	0.0125 ^(d)	10 ^d	Not Applicable	Not Applicable
			MIL-DTL-83528 Para. 4.5.15 (Q/C)	0.010	Not Applicable	Not Applicable	0.350	2.500 ^d
		Resistance During Vibration	MIL-DTL-83528 Para. 4.5.13 (Q)	0.010	Not Applicable	Not Applicable	Not Applicable	Not Applicable
Resistance After Vibration		MIL-DTL-83528 Para. 4.5.13 (Q)	0.005	Not Applicable	Not Applicable	Not Applicable	Not Applicable	
Post Tensile Set Volume Resistivity	MIL-DTL-83528 Para. 4.5.9 (Q/C)	0.010	Not Applicable	Not Applicable	Not Applicable	Not Applicable		
Regulatory	EMP Survivability, kA per in. perimeter	MIL-DTL-83528 Para. 4.5.16 (Q)	>0.9	Not Applicable	Not Applicable	Not Applicable	Not Applicable	
	RoHS Compliant	--	Yes	Yes	Yes	Yes	Yes	
	UL 94 Flammability Rating	UL 94	Not Tested	Not Tested	Not Tested	Not Tested	Not Tested	

Note A: Compression set is expressed as a percentage of deflection per ASTM D395 Method B, at 25% deflection. To determine percent recovery, subtract 0.25 of the stated compression set value from 100%. For example, in the case of 30% compression set, recovery is 92.5%.

Note B: Where two values are shown, the first represents max. operating temp. for conformance to MIL-DTL-83528 (which requires Group A life testing at 1.25 times max. operating temp.) and the second value represents the practical limit for exposure up to 1000 hrs. (compressed between flanges 7-10%). Single values conform to both definitions.

Note C: Copies of CEPS-0002, CHO-TP08 and CHO-TP09 are available from Chomerics. Contact Applications Engineering.

Note D: Heat aging condition: 100°C for 48 hrs.

Note E: Heat aging condition: 150°C for 48 hrs.

Note F: It may not be inferred that the same level of shielding effectiveness provided by a gasket material tested in the fixture per MIL-DTL-83528 Para. 4.5.12 would be provided in an actual equipment flange, since many mechanical factors of the flange design (tolerances, stiffness, fastener location and size, etc.) could lower or enhance shielding effectiveness. This procedure provides data applicable only to the test fixture design of MIL-DTL-83528, but which is useful for making comparisons between different gasket materials. The 40 GHz test data for all materials uses TP08 test method.

Note G: Heat aging condition: 200 °C for 48 hours

Note H: Heat aging condition: 125 °C for 1000 hours

continued on next page...

Elastomer Binder Legend

Silicone



Fluorosilicone



EPDM

Fluorocarbon/
Fluorosilicone

Elastomer Filler Legend

Corrosion Resistant on Aluminum



continued...Table 5-4: Material Guidelines - Specialty Products - continued

		Test Procedure (Type of Test)	CHO-SEAL V6433	CHO-SEAL S6600	
Physical	Molded (M) or Extruded (E)	--	M	M	
	Conductive Filler	--	Ag/Ni	Carbon	
	Elastomer Binder	--	Fluorocarbon/ Fluorosilicone	Silicone	
	Type (Ref. MIL-DTL-83528)	--	Not Applicable	Not Applicable	
	Volume Resistivity, ohm-cm, max., as supplied without pressure sensitive adhesive	CEPS-0002 ^c (Q/C)	Not Applicable	7	
		MIL-DTL-83528 (Q/C)	0.006	Not Applicable	
	Hardness, Shore A	ASTM D2240 (Q/C)	85 ±7	75 ±7	
	Specific Gravity	ASTM D792 (Q/C)	4.80 ± 0.25	1.20 ±0.25	
	Tensile Strength, psi (MPa), min.	ASTM D412 (Q/C)	400 (2.76)	650 (4.48)	
	Elongation, % min. or % min./max.	ASTM D412 (Q/C)	50	70	
	Tear Strength, lb/in. (kN/m), min.	ASTM D624 (Q)	70 (12.25)	Not Tested	
Compression Set, 70 hrs at 100°C, % max. ^(A)	ASTM D395, Method B (Q)	45	45		
Thermal	Low Temperature Flex TR10, °C, min.	ASTM D1329 (Q)	-25	-45	
	Maximum Continuous Use Temperature, °C ^(B)	--	200	200	
	Thermal Conductivity, W/m-K (Typical) 300 psi (2.07 MPa)	ASTM D5470	2.1	0.6	
Electrical	Shielding Effectiveness, dB, min. ^(F)	Method 1: CHO-TP08 ^c (Q)	Method 2	Method 1	
			Not Tested	Not Tested	
		Method 2: MIL-DTL-83528 Para. 4.5.12 (Q)	105	80	
			100	80	
			90	60	
		Method 3: CHO-TP09 ^c (Q)	90	50	
	Not Tested		Not Tested		
	Electrical Stability, ohm-cm, max.	CEPS-0002 ^c (Q)	0.008 ^g	7 ^(E)	
		Heat Aging	ohm-cm, max.	Not Applicable	Not Applicable
		Resistance During Vibration	MIL-DTL-83528 Para. 4.5.13 (Q)	Not Applicable	Not Applicable
Resistance After Vibration		MIL-DTL-83528 Para. 4.5.13 (Q)	Not Applicable	Not Applicable	
Post Tensile Set Volume Resistivity	MIL-DTL-83528 Para. 4.5.9 (Q/C)	Not Applicable	Not Applicable		
Regulatory	EMP Survivability, kA per in. perimeter	MIL-DTL-83528 Para. 4.5.16 (Q)	Not Applicable	Not Applicable	
	RoHS Compliant	--	Yes	Yes	
	UL 94 Flammability Rating	UL 94	Not tested	Not Tested	

Note A: Compression set is expressed as a percentage of deflection per ASTM D395 Method B, at 25% deflection. To determine percent recovery, subtract 0.25 of the stated compression set value from 100%. For example, in the case of 30% compression set, recovery is 92.5%.

Note B: Where two values are shown, the first represents max. operating temp. for conformance to MIL-DTL-83528 (which requires Group A life testing at 1.25 times max. operating temp.) and the second value represents the practical limit for exposure up to 1000 hrs. (compressed between flanges 7-10%). Single values conform to both definitions.

Note C: Copies of CEPS-0002, CHO-TP08 and CHO-TP09 are available from Chomerics. Contact Applications Engineering.

Note D: Heat aging condition: 100°C for 48 hrs.

Note E: Heat aging condition: 150°C for 48 hrs.

Note F: It may not be inferred that the same level of shielding effectiveness provided by a gasket material tested in the fixture per MIL-DTL-83528 Para. 4.5.12 would be provided in an actual equipment flange, since many mechanical factors of the flange design (tolerances, stiffness, fastener location and size, etc.) could lower or enhance shielding effectiveness. This procedure provides data applicable only to the test fixture design of MIL-DTL-83528, but which is useful for making comparisons between different gasket materials. The 40 GHz test data for all materials uses TP08 test method.

Note G: Heat aging condition: 200 °C for 48 hours

Note H: Heat aging condition: 125 °C for 1000 hours

Product Forms

STANDARD EXTRUSIONS – AN EXTENSIVE SELECTION

Our elastomer extrusions are hollow or solid strips in sizes ranging from 0.030 inch (0.76 mm) solid O cross section to a 4.00 inch (50.8 mm) wide flat ribbon. Existing tooling, available in hundreds of sizes, allows for immediate production of standard profiles:

- Solid O
- Hollow O
- Solid D
- Hollow D
- "Mushroom" D (patented)
- Solid Rectangle
- Hollow Rectangle
- Channel Strip
- Hollow P
- V Strip

Standard profiles are efficient for the majority of applications. Even problematic low closure force applications can be accommodated by lightweight, hollow gasketing.

There is generally no tooling charge for standard items. If needed, tooling of new dies for standard profiles is relatively inexpensive. Moreover, extrusions minimize material waste and do not require post-manufacture processing to remove flash. Subject only to packaging constraints, most extrusions are supplied on reels.

CUSTOM SHAPES IN ENDLESS VARIETY

Chomerics routinely produces elastomer extrusions in unusual sizes and intricate configurations to meet special needs. Explore the many specialized designs, for which tooling already exists. This showcase, beginning on page 65 of this guide, illustrates the variety and complexity that can be incorporated into extruded elastomers.

FINITE ELEMENTAL ANALYSIS – A POWERFUL DESIGN TOOL

Chomerics offers sophisticated FEA technology to prevent false starts, design delays and repetitive prototyping for unusual shielding requirements. Advanced computer simulation software is employed to predict gasket behavior, bypassing trial-and-error testing. FEA not only predicts how a design will behave, but allows it to be optimized. Complex algorithms provide critical information concerning: material selection, deformation, load-deflection, stress distribution, volume, void ratios, gland fill percent and more. The result is a technically superior solution achieved more rapidly and cost effectively than ever before.

MANUFACTURING LIMITATIONS

The extruded strips listed in this guide are generally available in all CHO-SEAL materials. However, the physical characteristics of certain materials make them unextrudable in very small sizes and with thin wall sections.

KISS-CUT GROUNDING PADS ON TAPE

For manual "peel and stick" or robotic "pick and place" application, grounding pads are readily produced in quantities by kiss-cutting hollow D (or other) extrusions to their PSA release tape. Features such as holes or slots can be incorporated, and Co-extrusions may also be cut. Continuous lengths are supplied on reels.



FULL-SERVICE FABRICATION

Often cost-competitive for both small and large volumes, conductive elastomer extrusions are readily fabricated for specific applications. These services are performed at the factory or by Chomerics' skilled Authorized Fabricators throughout the world. Visit www.parker.com/chomerics.

Cut-To-Length (CTL). Uniform parts are supplied ready for installation.

Standard Tolerances for cut parts, inch (mm)

- Less than 1.00 (25.4): ± 0.020 inch (0.51) *[cutting fixture required]*
- Lengths of 1.0 to 30.0 (25.4 to 762): ± 0.062 (1.58)
- Greater than 30.0 (762): $\pm 0.2\%$ the nominal dimension

NOTE: Tighter tolerances are available upon request.

PRECISION WASHERS

Slicing solid and hollow O cross sections into disks or washers can save time and cost, with tolerances equivalent to molded parts. For extremely thin parts, less than 0.060 inch (1.52 mm), Chomerics experience and tooling leads the industry.



SPLICED GASKETS

Extruded strips can be spliced to form a continuous seal. Spliced gaskets offer cost savings over molded gaskets without sacrificing performance. In particular, spliced hollow extrusions yield lightweight, low closure force gaskets at considerable savings. For solid silicone extrusions, the splice is often as strong and as resilient as the gasket itself and avoids mold flash.

Gaskets spliced by Chomerics or our Authorized Fabricators feature a vulcanized joint, formed under heat and pressure, that ensures functionality and a more uniform joint compared with adhesive bonding.

Minimum ID for Spliced O-Rings	Minimum ID
For profile cross sections between 0.032" - 0.043"	0.300"
For profile cross sections between 0.044" - 0.160"	7X the cross section

FRAME ASSEMBLIES

Chomerics fabricates complete frame/gasket assemblies either in their entirety or using customer-supplied parts. These incorporate vulcanized joints and miters, and often more than one gasket material or profile. With experience ranging from handheld devices to floor-standing equipment, size is not a limitation.

BONDED GASKETS

Similar and dissimilar compositions and profiles can be bonded in parallel for special requirements. Capabilities include bonded-in compression stops, holes and other features.

SMALL, DIE-CUT GASKETS FROM FLAT EXTRUSIONS

Standard rectangular extrusions up to 4 inches (101.6 mm) wide can provide an economical means of producing die-cut gaskets for some applications.

PRESSURE-SENSITIVE ADHESIVE (PSA)

Chomerics' extruded conductive elastomer EMI gaskets are available with non-conductive pressure-sensitive adhesive (PSA) tape for permanent attachment.

The acrylic pressure-sensitive adhesive does not appreciably affect the through-flange resistance of the EMI gasket because typically the PSA takes up only half the gasket footprint. The remainder of the gasket makes direct contact against both substrates.

Non-conductive PSA is preferred over conductive PSA because it exhibits higher peel strength than conductive PSA.

Note: Refer to page 30 for Applications detailed guidance on PSA systems.

Table 6-1: Extrusion Profile Minimum Bend Radii Guidelines	
Profile	Minimum Bend Radii*
Hollow O	2.0 x Outside Diameter
Solid O	1.5 x Diameter
Hollow D	2.0 x Width
Solid D	1.5 x Width
Channel	1.5 x Width
Hollow Rectangle	2.0 x Width
Solid Rectangle	Varies - Contact Applications Engineering
Hollow P	Varies - Contact Applications Engineering
Custom	Varies - Contact Applications Engineering

*Typical Minimum Inside Corner Radii of Gasket

Note: This table is minimum conditions, the numbers can increase based on the size, wall thickness, and configuration of the gasket.

ORDERING PROCEDURE

For standard or existing configurations, select the Chomerics part number from the tables that follow. The last four or five digits (represented by XXXX in the tables) designate the material type. In addition to the parts listed, all O strips up to 0.500 inch (12.7 mm) are considered standard. Not all combinations of OD and ID have part numbers assigned. Contact Chomerics for details.

For custom configurations, cut-to-length parts, spliced parts, etc., drawings or specifications must be provided. Part numbers will be assigned by Chomerics upon receipt. **Custom configurations requiring MIL-DTL-83528 certification are generally denoted by a -40 suffix.**

Pressure-sensitive adhesive may be ordered for any standard extrusion, other than O-strips, and many custom profiles, which have at least a 0.125 inch (3.17 mm) flat mating surface. The standard part numbers listed must be modified to

designate the PSA tape requirement per description below. Contact Chomerics for details.

Orders must also specify quantity (feet or inches are preferred). Please note that minimum quantities may apply.

Our Applications Engineering Specialists provide shielding gasket approaches that reduce overall manufacturing costs.

Part Numbering for EXTRUDED PRODUCTS

Example: 10-04-1687-1215

Part Number:



10 = Extrusion type
19 = Extrusion type

—



04 = Round
05 = D-shaped
06 = P-shaped
07 = Rectangular
08 = U-Channel
09 = Custom
18 = Co-extrusion
20 = PSA tape applied
22 = Fabricated cut gasket
24 = Bonded assembly

—



ZZZZZ = Cross section serial number (i.e., 1687)

—



XXXX = Material Type (i.e., 1215)
Refer to page 45.

EXTRUSION

Guide for Standard Extruded Shapes (Profiles)

Profile Description: Solid O-Shape and Hollow O Shape

Chomerics has or will build tooling for all outside diameters between 0.030 -0.500 inch (0.76 - 12.7 mm). Please consult with an Applications Engineer if the size you need is not shown in the table, and part numbers will be assigned.

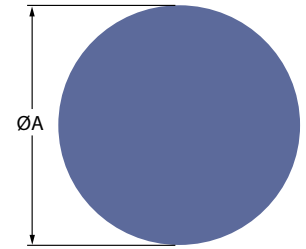

Table 6-3: Profiles, Solid O-Shape (Sorted by "A" Dimension)

Part Number	Nominal Dimension		Suggested Groove Dimensions*			
	ØA		Depth		Width	
			± 0.002 inch	± 0.05 mm	± 0.002 inch	± 0.05 mm
	inch	mm	inch	mm	inch	mm
19-04-26721-XXXX**	0.030	0.76	-	-	-	-
19-04-W993-XXXX	0.030	0.76	-	-	-	-
19-04-31321-XXXX**	0.033	0.84	-	-	-	-
19-04-12897-XXXX	0.033	0.84	-	-	-	-
19-04-23913-XXXX	0.035	0.89	-	-	-	-
10-04-6386-XXXX**	0.040	1.02	0.031	0.79	0.054	1.37
19-04-22085-XXXX	0.040	1.02	0.029	0.74	0.063	1.60
19-04-22371-XXXX**	0.043	1.09	0.034	0.86	0.056	1.42
19-04-22533-XXXX	0.043	1.09	0.032	0.81	0.064	1.63
19-04-27855-XXXX**	0.048	1.22	0.038	0.97	0.061	1.55
10-04-9139-XXXX	0.048	1.22	0.037	0.94	0.067	1.70
19-04-25875-XXXX**	0.050	1.27	0.040	1.02	0.062	1.57
19-04-22087-XXXX	0.050	1.27	0.038	0.97	0.070	1.78
19-04-20581-XXXX**	0.053	1.35	0.043	1.09	0.064	1.63
10-04-3560-XXXX	0.053	1.35	0.041	1.04	0.072	1.83
19-04-28067-XXXX**	0.060	1.52	0.049	1.24	0.070	1.78
19-04-22354-XXXX	0.060	1.52	0.047	1.19	0.078	1.98
19-04-27546-XXXX**	0.062	1.57	0.051	1.30	0.072	1.83
10-04-2561-XXXX	0.062	1.57	0.049	1.24	0.079	2.01
19-04-28402-XXXX**	0.065	1.68	0.054	1.37	0.076	1.93
19-04-22049-XXXX	0.066	1.68	0.053	1.35	0.082	2.08
19-04-22951-XXXX**	0.070	1.78	0.057	1.45	0.080	2.03
10-04-1687-XXXX	0.070	1.78	0.056	1.42	0.086	2.18
19-04-24514-XXXX	0.073	1.85	0.059	1.50	0.088	2.24
19-04-12898-XXXX	0.074	1.88	0.060	1.52	0.089	2.26
19-04-11228-XXXX	0.075	1.91	0.061	1.55	0.090	2.29
19-04-12899-XXXX	0.077	1.96	0.063	1.60	0.091	2.31
19-04-12900-XXXX	0.079	2.01	0.064	1.63	0.094	2.39
10-04-2657-XXXX	0.080	2.03	0.065	1.65	0.095	2.41
19-04-12901-XXXX	0.085	2.16	0.069	1.75	0.100	2.54
19-04-M394-XXXX	0.090	2.29	0.074	1.88	0.103	2.62
10-04-2865-XXXX	0.093	2.36	0.076	1.93	0.107	2.72
10-04-3509-XXXX	0.100	2.54	0.082	2.08	0.113	2.87

Part Number	Nominal Dimension		Suggested Groove Dimensions*			
	ØA		Depth		Width	
			± 0.002 inch	± 0.05 mm	± 0.002 inch	± 0.05 mm
	inch	mm	inch	mm	inch	mm
10-04-1720-XXXX	0.103	2.62	0.084	2.13	0.117	2.97
19-04-12902-XXXX	0.106	2.69	0.087	2.21	0.119	3.02
10-04-2866-XXXX	0.112	2.84	0.092	2.34	0.125	3.18
19-04-22993-XXXX	0.115	2.92	0.094	2.39	0.129	3.28
10-04-3077-XXXX	0.119	3.02	0.098	2.49	0.131	3.33
10-04-2463-XXXX	0.125	3.18	0.102	2.59	0.139	3.53
10-04-2862-XXXX	0.130	3.30	0.107	2.72	0.142	3.61
19-04-12903-XXXX	0.134	3.40	0.110	2.79	0.146	3.71
19-04-23338-XXXX	0.136	3.45	0.112	2.84	0.148	3.76
10-04-1721-XXXX	0.139	3.53	0.114	2.90	0.152	3.86
19-04-12904-XXXX	0.147	3.73	0.120	3.05	0.160	4.06
10-04-3982-XXXX	0.150	3.81	0.123	3.12	0.163	4.14
19-04-25361-XXXX	0.156	3.96	0.128	3.25	0.169	4.29
19-04-12906-XXXX	0.158	4.01	0.129	3.28	0.171	4.34
10-04-3231-XXXX	0.160	4.06	0.131	3.33	0.173	4.39
19-04-12907-XXXX	0.170	4.32	0.139	3.53	0.182	4.62
19-04-F371-XXXX	0.188	4.78	0.154	3.91	0.200	5.08
19-04-12908-XXXX	0.195	4.95	0.160	4.06	0.207	5.26
19-04-20919-XXXX	0.210	5.33	0.173	4.39	0.227	5.77
10-04-2864-XXXX	0.216	5.49	0.177	4.50	0.234	5.94
19-04-12909-XXXX	0.219	5.56	0.179	4.55	0.238	6.05
19-04-12910-XXXX	0.236	5.99	0.193	4.90	0.254	6.45
19-04-12911-XXXX	0.247	6.27	0.202	5.13	0.265	6.73
10-04-3076-XXXX	0.250	6.35	0.205	5.21	0.268	6.81
19-04-25051-XXXX	0.275	6.99	0.226	5.74	0.291	7.39
10-04-9769-XXXX	0.280	7.11	0.230	5.84	0.297	7.54
19-04-12912-XXXX	0.291	7.39	0.238	6.05	0.309	7.85
19-04-27818-XXXX	0.335	8.51	0.275	6.99	0.351	8.92
19-04-12918-XXXX	0.367	9.32	0.301	7.65	0.387	9.83
19-04-12919-XXXX	0.379	9.63	0.310	7.87	0.400	10.16
19-04-12920-XXXX	0.393	9.98	0.322	8.18	0.413	10.49

Standard Tolerances (inch)

<0.200: ±0.005

0.200 - 0.349: ±0.008

0.350 - 0.500: ±0.010

>0.500: ±3% Nom. Dim.

Dimensions listed for reference only.

Please see Chomerics drawing for revision-controlled specifications.

*Contact Chomerics Applications Engineering for groove design assistance.

** This part diameter is held to ±.003".

Most commonly selected profiles

EXTRUSION

- ^a Non-Friction Fit Groove recommendations are based on 50% compression of the inside diameter (Dimension B) and meeting the remainder of the Hollow O design goals in Section 3, Page 19.
- ^b Friction Fit Groove recommendations in this table are one of many possible friction fit solutions. Those listed here are based on meeting 50% compression of the inside diameter (Dimension B) nominally. This calculation takes into account the increase in overall gasket height, due to the friction fit groove and meeting the remainder of the Hollow O design goals in Section 3, Page 19. Contact Applications Engineering for additional possible options.

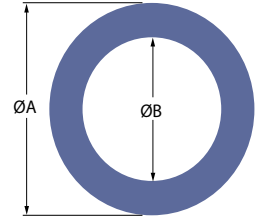

Table 6-4: Profiles, Hollow-O-Shape (Sorted by "A" Dimension)

Part Number	Nominal Dimension				Non-Friction Fit Groove ^a		Non-Friction Fit Groove ^a		Friction Fit Groove ^b		Friction Fit Groove ^b					
	inch		mm		Depth	Width	Depth	Width	Depth	Width	Depth	Width				
	A	B	A	B	±.002 inch	±.002 inch	±.05 mm	±.05 mm	±.002 inch	±.002 inch	±.05 mm	±.05 mm				
					Groove		Groove		Groove		Groove					
10-04-21120-XXXX	0.053	0.020	1.35	0.51	Contact Applications*		Contact Applications*		Contact Applications*		Contact Applications*					
10-04-W137-XXXX	0.060	0.020	1.52	0.51												
10-04-W163-XXXX	0.062	0.035	1.57	0.89	0.044	0.071	1.12	1.80								
19-04-22710-XXXX	0.063	0.023	1.60	0.58	Contact Applications*		Contact Applications*									
19-04-14964-XXXX	0.070	0.020	1.78	0.51												
19-04-25856-XXXX	0.070	0.040	1.78	1.02	0.050	0.077	1.27	1.96								
19-04-22129-XXXX	0.073	0.033	1.85	0.84	0.056	0.082	1.42	2.08								
19-04-24444-XXXX	0.074	0.020	1.88	0.51	Contact Applications*		Contact Applications*									
19-04-23365-XXXX	0.075	0.045	1.90	1.14	0.052	0.082	1.32	2.08								
19-04-26950-XXXX	0.078	0.043	1.98	1.09	0.056	0.085	1.42	2.16								
19-04-15465-XXXX	0.080	0.030	2.03	0.76	0.065	0.087	1.65	2.21								
19-04-14206-XXXX	0.080	0.040	2.03	1.02	0.060	0.087	1.52	2.21								
19-04-11204-XXXX	0.081	0.020	2.06	0.51	Contact Applications*		Contact Applications*									
19-04-22678-XXXX	0.083	0.043	2.11	1.09	0.061	0.090	1.55	2.29								
19-04-12570-XXXX	0.083	0.050	2.11	1.27	0.058	0.090	1.47	2.29								
19-04-26087-XXXX	0.085	0.045	2.16	1.14	0.062	0.092	1.57	2.34								
19-04-23086-XXXX	0.090	0.020	2.29	0.51	Contact Applications*		Contact Applications*									
10-04-W267-XXXX	0.090	0.050	2.29	1.27	0.065	0.097	1.65	2.46					0.072	0.083	1.78	2.11
10-04-W293-XXXX	0.090	0.060	2.29	1.52	0.060	0.097	1.52	2.46					0.062	0.083	1.57	2.11
19-04-22970-XXXX	0.093	0.033	2.36	0.84	0.076	0.100	1.93	2.54					Contact Applications*		Contact Applications*	
19-04-20072-XXXX	0.093	0.040	2.36	1.02	0.073	0.100	1.85	2.54								
19-04-25602-XXXX	0.100	0.040	2.54	1.02	0.080	0.107	2.03	2.72								
19-04-12744-XXXX	0.100	0.060	2.54	1.52	0.070	0.107	1.78	2.72	0.073	0.093	1.85	2.36				
19-04-16162-XXXX	0.100	0.070	2.54	1.78	0.065	0.107	1.65	2.72	0.067	0.093	1.70	2.36				
19-04-11205-XXXX	0.102	0.039	2.59	0.99	0.082	0.109	2.08	2.77	Contact Applications*		Contact Applications*					
19-04-20946-XXXX	0.102	0.051	2.59	1.30	0.076	0.109	1.93	2.77								
10-04-8363-XXXX	0.103	0.040	2.62	1.02	0.083	0.110	2.11	2.79								
19-04-24415-XXXX	0.103	0.053	2.62	1.35	0.076	0.110	1.93	2.79								
19-04-24652-XXXX	0.103	0.075	2.62	1.90	0.065	0.110	1.65	2.79	0.067	0.096	1.70	2.44				
19-04-11218-XXXX	0.110	0.045	2.79	1.14	0.087	0.117	2.21	2.97	Contact Applications*		Contact Applications*					
19-04-14120-XXXX	0.110	0.062	2.79	1.57	0.079	0.117	2.01	2.97	0.082	0.103	2.08	2.62				
19-04-15278-XXXX	0.110	0.068	2.79	1.73	0.076	0.117	1.93	2.97	0.078	0.103	1.98	2.62				
19-04-15586-XXXX	0.118	0.050	3.00	1.27	0.093	0.125	2.36	3.18	0.099	0.111	2.51	2.82				
19-04-12534-XXXX	0.118	0.079	3.00	2.01	0.079	0.125	2.01	3.18	0.080	0.111	2.03	2.82				
19-04-11216-XXXX	0.122	0.061	3.10	1.55	0.099	0.129	2.51	3.28	0.095	0.115	2.41	2.92				
10-04-2999-XXXX	0.125	0.045	3.17	1.14	0.102	0.132	2.59	3.35	Contact Applications*		Contact Applications*					

* No groove recommendation is available for this profile that meets Chomerics recommended Hollow O design criteria. Contact Applications Engineering for assistance. Friction Fit groove recommendations in **BOLD**, have from only 43% to 46% nominal compression of the inside diameter, rather than the 50% desired goal. These are limited by the 97% maximum groove overfill constraints. Section 3, Page 19. For design goals.

Most commonly selected profiles

EXTRUSION

- a Non-Friction Fit Groove recommendations are based on 50% compression of the inside diameter (Dimension B) and meeting the remainder of the Hollow O design goals in Section 3, Page 19.
- b Friction Fit Groove recommendations in this table are one of many possible friction fit solutions. Those listed here are based on meeting 50% compression of the inside diameter (Dimension B) nominally. This calculation takes into account the increase in overall gasket height, due to the friction fit groove and meeting the remainder of the Hollow O design goals in Section 3, Page 19. Contact Applications Engineering for additional possible options.

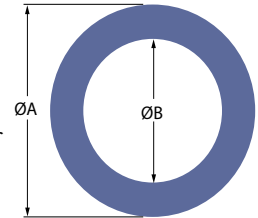

Table 6-4: Profiles, Hollow-O-Shape (Sorted by "A" Dimension) (Cont.)

Part Number	Nominal Dimension				Non-Friction Fit Groove ^a		Non-Friction Fit Groove ^a		Friction Fit Groove ^b		Friction Fit Groove ^b	
					Groove		Groove		Groove		Groove	
	inch		mm		Depth	Width	Depth	Width	Depth	Width	Depth	Width
	A	B	A	B	±.002 inch	±.002 inch	±.05 mm	±.05 mm	±.002 inch	±.002 inch	±.05 mm	±.05 mm
19-04-23836-XXXX	0.125	0.055	3.17	1.40	0.097	0.132	2.46	3.35	0.103	0.118	2.62	3.00
10-04-8817-XXXX	0.125	0.062	3.17	1.57	0.094	0.132	2.39	3.35	0.096	0.118	2.44	3.00
19-04-13564-XXXX	0.125	0.070	3.17	1.78	0.090	0.132	2.29	3.35	0.091	0.118	2.31	3.00
10-04-W204-XXXX	0.125	0.078	3.17	1.98	0.086	0.132	2.18	3.35	0.088	0.118	2.24	3.00
19-04-11283-XXXX	0.125	0.080	3.17	2.03	0.085	0.132	2.16	3.35	0.087	0.118	2.21	3.00
10-04-W775-XXXX	0.125	0.085	3.17	2.16	0.082	0.132	2.08	3.35	0.084	0.118	2.13	3.00
10-04-5514-XXXX	0.130	0.045	3.30	1.14	0.107	0.137	2.72	3.48	0.113	0.123	2.87	3.12
19-04-25964-XXXX	0.130	0.050	3.30	1.27	0.105	0.137	2.67	3.48	0.110	0.123	2.79	3.12
19-04-23097-XXXX	0.130	0.090	3.30	2.29	0.085	0.137	2.16	3.48	0.087	0.123	2.21	3.12
19-04-16390-XXXX	0.135	0.045	3.43	1.14	0.112	0.142	2.84	3.61	0.118	0.128	3.00	3.25
19-04-16104-XXXX	0.135	0.055	3.43	1.40	0.107	0.142	2.72	3.61	0.112	0.128	2.84	3.25
19-04-16009-XXXX	0.135	0.085	3.43	2.16	0.092	0.142	2.34	3.61	0.094	0.128	2.39	3.25
19-04-X787-XXXX	0.135	0.097	3.43	2.46	0.086	0.142	2.18	3.61	0.089	0.128	2.26	3.25
19-04-14632-XXXX	0.137	0.087	3.48	2.21	0.093	0.144	2.36	3.66	0.095	0.130	2.41	3.30
19-04-11497-XXXX	0.140	0.046	3.56	1.17	0.117	0.147	2.97	3.73	0.122	0.133	3.10	3.38
19-04-11289-XXXX	0.145	0.070	3.68	1.78	0.110	0.152	2.79	3.86	0.112	0.138	2.84	3.51
19-04-13118-XXXX	0.145	0.080	3.68	2.03	0.105	0.152	2.67	3.86	0.107	0.138	2.72	3.51
19-04-14930-XXXX	0.151	0.094	3.84	2.39	0.104	0.158	2.64	4.01	0.106	0.144	2.69	3.66
19-04-21919-XXXX	0.153	0.105	3.89	2.67	0.100	0.160	2.54	4.06	0.102	0.146	2.59	3.71
19-04-13545-XXXX	0.153	0.115	3.89	2.92	0.095	0.160	2.41	4.06	0.097	0.146	2.46	3.71
19-04-23209-XXXX	0.156	0.035	3.96	0.89	0.134	0.163	3.40	4.14	Not Recommended*		Not Recommended*	
10-04-4180-XXXX	0.156	0.050	3.96	1.27	0.131	0.163	3.33	4.14	0.133	0.149	3.38	3.78
10-04-9732-XXXX	0.156	0.080	3.96	2.03	0.116	0.163	2.95	4.14	0.118	0.149	3.00	3.78
19-04-26590-XXXX	0.156	0.102	3.96	2.59	0.105	0.163	2.67	4.14	0.107	0.149	2.72	3.78
19-04-26424-XXXX	0.168	0.110	4.27	2.79	0.113	0.175	2.87	4.45	0.115	0.161	2.92	4.09
19-04-26610-XXXX	0.170	0.062	4.32	1.57	0.139	0.177	3.53	4.50	0.141	0.163	3.58	4.14
19-04-26593-XXXX	0.177	0.077	4.50	1.96	0.138	0.184	3.51	4.67	0.140	0.170	3.56	4.32
10-04-8133-XXXX	0.177	0.079	4.50	2.01	0.137	0.184	3.48	4.67	0.139	0.170	3.53	4.32
19-04-21639-XXXX	0.177	0.090	4.50	2.29	0.132	0.184	3.35	4.67	0.134	0.170	3.40	4.32
19-04-13189-XXXX	0.177	0.110	4.50	2.79	0.122	0.184	3.10	4.67	0.124	0.170	3.15	4.32
19-04-20982-XXXX	0.177	0.125	4.50	3.17	0.115	0.184	2.92	4.67	0.116	0.170	2.95	4.32
19-04-22324-XXXX	0.177	0.137	4.50	3.48	0.109	0.184	2.77	4.67	0.110	0.170	2.79	4.32
19-04-11214-XXXX	0.180	0.140	4.57	3.56	0.110	0.187	2.79	4.75	0.112	0.173	2.84	4.39
19-04-12128-XXXX	0.188	0.125	4.78	3.17	0.125	0.195	3.18	4.95	0.127	0.181	3.23	4.60
19-04-14537-XXXX	0.189	0.111	4.80	2.82	0.133	0.196	3.38	4.98	0.135	0.182	3.43	4.62
10-04-4254-XXXX	0.190	0.080	4.83	2.03	0.150	0.197	3.81	5.00	0.152	0.183	3.86	4.65

* No groove recommendation is available for this profile that meets Chomerics recommended Hollow O design criteria. Contact Applications Engineering for assistance. Friction Fit groove recommendations in **BOLD**, have from only 43% to 46% nominal compression of the inside diameter, rather than the 50% desired goal. These are limited by the 97% maximum groove overfill constraints. Section 3, Page 19. For design goals.

Most commonly selected profiles

Table 6-4: Profiles, Hollow-O-Shape (Sorted by "A" Dimension) (Cont.)

Part Number	Nominal Dimension (inch)		Nominal Dimension (mm)	
	A	B	A	B
19-04-26381-XXXX	0.190	0.115	4.83	2.92
19-04-21194-XXXX	0.195	0.155	4.95	3.94
19-04-12015-XXXX	0.207	0.077	5.26	1.96
19-04-15435-XXXX	0.207	0.090	5.26	2.29
19-04-16084-XXXX	0.207	0.134	5.26	3.40
19-04-26772-XXXX	0.207	0.144	5.26	3.66
19-04-E483-XXXX	0.210	0.093	5.33	2.36
19-04-22066-XXXX	0.210	0.100	5.33	2.54
19-04-15479-XXXX	0.210	0.120	5.33	3.05
19-04-C627-XXXX	0.216	0.090	5.49	2.29
19-04-20848-XXXX	0.220	0.170	5.59	4.32
19-04-23158-XXXX	0.236	0.118	5.99	3.00
19-04-21163-XXXX	0.250	0.110	6.35	2.79
10-04-2737-XXXX	0.250	0.125	6.35	3.17
19-04-15434-XXXX	0.250	0.140	6.35	3.56
19-04-21162-XXXX	0.250	0.147	6.35	3.73
19-04-12792-XXXX	0.250	0.150	6.35	3.81
19-04-15443-XXXX	0.250	0.187	6.35	4.75
19-04-21161-XXXX	0.250	0.192	6.35	4.88
19-04-14349-XXXX	0.250	0.200	6.35	5.08
19-04-W049-XXXX	0.290	0.156	7.37	3.96
10-04-3221-XXXX	0.290	0.175	7.37	4.44
19-04-19133-XXXX	0.312	0.115	7.92	2.92
10-04-3004-XXXX	0.312	0.192	7.92	4.88
19-04-16906-XXXX	0.335	0.202	8.51	5.13
19-04-22253-XXXX	0.343	0.168	8.71	4.27
19-04-13759-XXXX	0.348	0.250	8.84	6.35
19-04-14292-XXXX	0.373	0.200	9.47	5.08
10-04-3122-XXXX	0.375	0.250	9.52	6.35
19-04-12102-XXXX	0.376	0.148	9.55	3.76
19-04-22230-XXXX	0.390	0.295	9.91	7.49
19-04-19324-XXXX	0.390	0.328	9.91	8.33
19-04-14467-XXXX	0.394	0.253	10.01	6.43
19-04-12338-XXXX	0.430	0.330	10.92	8.38
19-04-3685-XXXX	0.437	0.250	11.10	6.35
10-04-4034-XXXX	0.437	0.347	11.10	8.81
19-04-14261-XXXX	0.461	0.295	11.71	7.49
10-04-3649-XXXX	0.470	0.345	11.94	8.76
19-04-11651-XXXX	0.524	0.315	13.31	8.00
19-04-22208-XXXX	0.543	0.184	13.79	4.67
19-04-21440-XXXX	0.545	0.395	13.84	10.03

Most commonly selected profiles

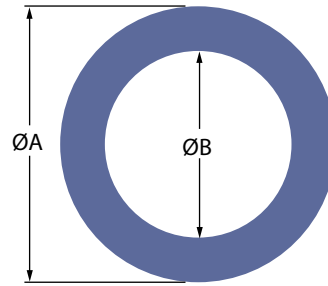

NOTE:
Due to the hollow profile's nature, multiple groove sizes are possible. Contact Chomerics Applications Engineering for design assistance.

Part Number	Nominal Dimension (inch)		Nominal Dimension (mm)	
	A	B	A	B
19-04-27626-XXXX	0.610	0.075	15.49	1.90
10-04-5516-XXXX	0.620	0.515	15.75	13.08
19-04-15181-XXXX	0.625	0.250	15.88	6.35
10-04-4148-XXXX	0.630	0.515	16.00	13.08
19-04-23379-XXXX	0.644	0.581	16.36	14.76
19-04-21493-XXXX	0.676	0.613	17.17	15.57
19-04-11875-XXXX	0.812	0.500	20.62	12.70
19-04-20951-XXXX	0.893	0.770	22.68	19.56
19-04-17364-XXXX	1.240	1.150	31.50	29.21

Standard Tolerances (inch)
 <0.200: ±0.005
 0.200 - 0.349: ±0.008
 0.350 - 0.500: ±0.010
 >0.500: ±3% Nom. Dim.

Dimensions listed for reference only.
Please see Chomerics drawing for revision-controlled specifications.

For profiles 0.190" outside diameter and greater, please contact Chomerics Applications Engineering for groove design assistance.

Profile Description: P Shape

Table 6-5: Profiles, P-Shape (Sorted by "A" Dimension)

Part Number	Nominal Dimension (inch)				Nominal Dimension (mm)			
	A	B	C	D	A	B	C	D
19-06-12489-XXXX	0.075	0.025	-	0.045	1.90	0.64	-	1.14
19-06-10819-XXXX	0.076	0.028	0.124	0.033	1.93	0.71	3.15	0.84
19-06-26676-XXXX	0.090	0.045	0.160	0.025	2.29	1.14	4.06	0.64
19-06-M151-XXXX	0.125	0.045	0.250	0.062	3.17	1.14	6.35	1.57
19-06-Z731-XXXX	0.140	0.100	0.135	0.030	3.56	2.54	3.43	0.76
19-06-C442-XXXX	0.164	0.084	0.040	0.095	4.17	2.13	1.02	2.41
19-06-M412-XXXX	0.168	0.047	0.200	0.062	4.27	1.19	5.08	1.57
10-06-B227-XXXX	0.190	0.130	0.312	0.062	4.83	3.30	7.92	1.57
19-06-20879-XXXX	0.190	0.136	0.312	0.030	4.83	3.45	7.92	0.76
10-06-A778-XXXX	0.200	0.080	0.215	0.062	5.08	2.03	5.46	1.57
19-06-11223-XXXX	0.200	0.080	0.310	0.052	5.08	2.03	7.87	1.32
10-06-8560-XXXX	0.200	0.080	0.425	0.062	5.08	2.03	10.80	1.57
19-06-12942-XXXX	0.200	0.080	0.400	0.062	5.08	2.03	10.16	1.57
10-06-8550-XXXX	0.200	0.080	0.275	0.062	5.08	2.03	6.99	1.57
10-06-8737-XXXX	0.200	0.080	0.250	0.062	5.08	2.03	6.35	1.57
19-06-13514-XXXX	0.200	0.080	0.125	0.062	5.08	2.03	3.17	1.57
10-06-6175-XXXX	0.200	0.080	0.550	0.062	5.08	2.03	13.97	1.57
10-06-3599-XXXX	0.200	0.080	0.650	0.062	5.08	2.03	16.51	1.57
19-06-13217-XXXX	0.200	0.125	0.650	0.062	5.08	3.17	16.51	1.57
10-06-6180-XXXX	0.250	0.125	0.625	0.062	6.35	3.17	15.88	1.57
10-06-4142-XXXX	0.250	0.125	0.250	0.062	6.35	3.17	6.35	1.57
10-06-3300-XXXX	0.250	0.125	0.375	0.062	6.35	3.17	9.52	1.57
10-06-4921-XXXX	0.250	0.150	0.375	0.062	6.35	3.81	9.52	1.57
10-06-8778-XXXX	0.250	0.125	0.350	0.062	6.35	3.17	8.89	1.57
10-06-C716-XXXX	0.254	0.153	0.254	0.062	6.45	3.89	6.45	1.57
19-06-22037-XXXX	0.310	0.210	0.145	0.050	7.87	5.33	3.68	1.27
10-06-5611-XXXX	0.312	0.187	0.563	0.062	7.92	4.75	14.30	1.57
10-06-2750-XXXX	0.360	0.255	0.420	0.070	9.14	6.48	10.67	1.78
19-06-27536-XXXX	0.250	0.188	0.500	0.062	6.35	4.78	12.70	1.57
19-06-16770-XXXX	0.375	0.250	0.625	0.075	9.52	6.35	15.88	1.90
19-06-L064-XXXX	0.600	0.400	0.350	0.110	15.24	10.16	8.89	2.79
19-06-15899-XXXX	0.610	0.350	0.875	0.130	15.49	8.89	22.22	3.30
19-06-11384-XXXX	0.750	0.625	0.725	0.062	19.05	15.88	18.41	1.57

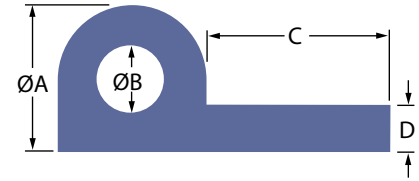

Standard Tolerances (inch)

<0.200: ±0.005
 0.200 - 0.349: ±0.008
 0.350 - 0.500: ±0.010
 >0.500: ±3% Nom. Dim.

Most commonly selected profiles

Dimensions listed for reference only.

Please see Chomerics drawing for revision-controlled specifications.

Contact Chomerics Applications Engineering for groove design assistance.

(For PSA on bottom of "P" profile, change -06 to -20)

Profile Description: Channel Shape

Table 6-6: Profiles, Channel-Shape (Sorted by "A" Dimension)

Part Number	Nominal Dimension (inch)				Nominal Dimension (mm)			
	A	B	C	D	A	B	C	D
19-08-14054-XXXX	0.075	0.099	0.025	0.032	1.90	2.51	0.64	0.81
10-08-6475-XXXX	0.100	0.100	0.034	0.033	2.54	2.54	0.86	0.84
19-08-22217-XXXX	0.125	0.188	0.025	0.062	3.17	4.78	0.64	1.57
19-08-12880-XXXX	0.126	0.078	0.044	0.048	3.20	1.98	1.12	1.22
19-08-12881-XXXX	0.126	0.099	0.047	0.059	3.20	2.51	1.19	1.50
10-08-3215-XXXX	0.126	0.110	0.025	0.050	3.20	2.79	0.64	1.27
10-08-4315-XXXX	0.126	0.225	0.020	0.075	3.20	5.71	0.51	1.90
19-08-17623-XXXX	0.154	0.114	0.082	0.048	3.91	2.90	2.08	1.22
10-08-3157-XXXX	0.156	0.156	0.062	0.047	3.96	3.96	1.57	1.19
19-08-12844-XXXX	0.156	0.175	0.046	0.075	3.96	4.44	1.17	1.90
10-08-3253-XXXX	0.175	0.156	0.047	0.075	4.44	3.96	1.19	1.90
10-08-F815-XXXX	0.188	0.188	0.062	0.062	4.78	4.78	1.57	1.57
19-08-23568-XXXX	0.190	0.270	0.050	0.065	4.83	6.86	1.27	1.65
19-08-C929-XXXX	0.250	0.250	0.130	0.062	6.35	6.35	3.30	1.57
19-08-12885-XXXX	0.260	0.184	0.140	0.062	6.60	4.67	3.56	1.57
19-08-17068-XXXX	0.312	0.187	0.190	0.061	7.92	4.75	4.83	1.55
19-08-12886-XXXX	0.320	0.315	0.193	0.197	8.13	8.00	4.90	5.00
10-08-3872-XXXX	0.327	0.235	0.062	0.115	8.31	5.97	1.57	2.92
10-08-8754-XXXX	0.330	0.215	0.170	-	8.38	5.46	4.32	-
19-08-E622-XXXX	0.375	0.500	0.187	0.125	9.52	12.70	4.75	3.17

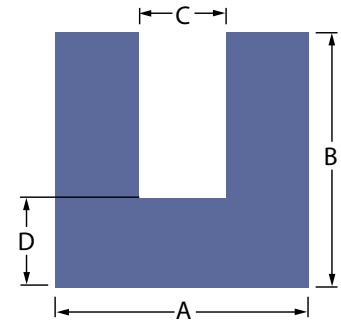

Standard Tolerances (inch)
 <0.200: ±0.005
 0.200 - 0.349: ±0.008
 0.350 - 0.500: ±0.010
 >0.500: ±3% Nom. Dim.

Most commonly selected profiles

Dimensions listed for reference only.
 Please see Chomerics drawing for revision-controlled specifications.
 Contact Chomerics Applications Engineering for groove design assistance.

(For PSA on bottom of "U" profile, change -08 to -20)

EXTRUSION

Profile Description: D Shape

Table 6-7: Profiles, D-Shape (Sorted by "B" Dimension)

Part Number	Nominal Dimension (inch)			Nominal Dimension (mm)		
	A	B	C	A	B	C
19-05-21166-XXXX	0.035	0.035	0.018	0.89	0.89	0.46
19-05-16047-XXXX	0.021	0.040	0.010	0.53	1.02	0.25
19-05-20935-XXXX	0.150	0.052	0.200	3.81	1.32	5.08
19-05-14769-XXXX	0.035	0.062	0.018	0.89	1.57	0.46
10-05-5589-XXXX	0.055	0.064	0.028	1.40	1.63	0.71
10-05-1362-XXXX	0.062	0.068	0.031	1.57	1.73	0.79
19-05-14422-XXXX	0.055	0.070	0.055	1.40	1.78	1.40
19-05-E163-XXXX	0.062	0.074	0.031	1.57	1.88	0.79
10-05-Z337-XXXX	0.060	0.075	0.030	1.52	1.90	0.76
10-05-3224-XXXX	0.094	0.078	0.047	2.39	1.98	1.19
19-05-12888-XXXX	0.088	0.081	0.044	2.24	2.06	1.12
19-05-12883-XXXX	0.062	0.085	0.031	1.57	2.16	0.79
10-05-1363-XXXX	0.078	0.089	0.039	1.98	2.26	0.99
19-05-Z586-XXXX	0.094	0.094	0.047	2.39	2.39	1.19
10-05-4699-XXXX	0.062	0.100	0.031	1.57	2.54	0.79
19-05-23159-XXXX	0.125	0.110	0.062	3.17	2.79	1.57
10-05-2618-XXXX	0.150	0.110	0.075	3.81	2.79	1.90
19-05-C128-XXXX	0.102	0.115	0.051	2.59	2.92	1.30
19-05-21124-XXXX	0.165	0.118	0.083	4.19	3.00	2.11
19-05-F084-XXXX	0.125	0.125	0.062	3.17	3.17	1.57
19-05-25354-XXXX	0.125	0.125	0.062	3.17	3.17	1.57
10-05-A283-XXXX	0.122	0.131	0.061	3.10	3.33	1.55
19-05-A611-XXXX	0.091	0.134	0.045	2.31	3.40	1.14
10-05-1364-XXXX	0.122	0.135	0.061	3.10	3.43	1.55
19-05-11558-XXXX	0.098	0.150	0.039	2.49	3.81	0.99
10-05-1499-XXXX	0.118	0.156	0.059	3.00	3.96	1.50
19-05-F173-XXXX	0.156	0.156	0.078	3.96	3.96	1.98
10-05-1577-XXXX	0.178	0.175	0.089	4.52	4.44	2.26
19-05-W469-XXXX	0.188	0.188	0.094	4.78	4.78	2.39
10-05-A381-XXXX	0.187	0.200	0.093	4.75	5.08	2.36

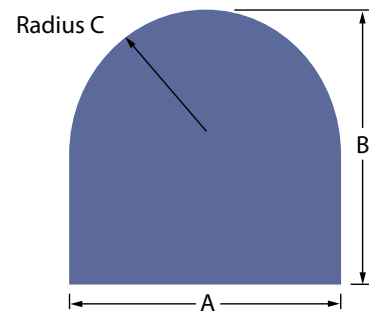

Standard Tolerances (inch)
 <0.200: ±0.005
 0.200 - 0.349: ±0.008
 0.350 - 0.500: ±0.010
 >0.500: ±3% Nom. Dim.

Most commonly selected profiles

Dimensions listed for reference only.
 Please see Chomerics drawing for revision-controlled specifications.
 Contact Chomerics Applications Engineering for groove design assistance.

(For PSA, change -05 to -20)

Profile Description: Hollow D Shape

Table 6-8: Profiles, Hollow D-Shape (Sorted by "B" Dimension)

Part Number	Nominal Dimension (inch)			Nominal Dimension (mm)		
	A	B	C	A	B	C
19-05-14960-XXXX	0.157	0.076	0.020	3.99	1.93	0.051
19-05-24810-XXXX	0.125	0.093	0.025	3.17	2.36	0.64
19-05-23617-XXXX	0.085	0.095	0.020	2.16	2.41	0.51
19-05-11440-XXXX	0.246	0.145	0.030	6.25	3.68	0.76
19-05-9514-XXXX	0.100	0.148	0.040	2.54	3.76	1.02
19-05-15343-XXXX	0.125	0.156	0.040	3.17	3.96	1.02
19-05-20355-XXXX	0.135	0.156	0.040	3.43	3.96	1.02
10-05-6419-XXXX	0.156	0.156	0.045	3.96	3.96	1.14
19-05-21357-XXXX	0.200	0.156	0.045	5.08	3.96	1.14
19-05-19354-XXXX	0.126	0.185	0.028	3.20	4.70	0.71
19-05-17261-XXXX	0.186	0.186	0.040	4.72	4.72	1.02
10-05-4202-XXXX	0.187	0.187	0.050	4.75	4.75	1.27
19-05-11231-XXXX	0.207	0.187	0.050	5.26	4.75	1.27
19-05-10277-XXXX	0.296	0.187	0.030	7.52	4.75	0.76
19-05-21741-XXXX	0.296	0.187	0.030	7.52	4.75	0.76
19-05-L467-XXXX	0.296	0.187	0.050	7.52	4.75	1.27
19-05-17485-XXXX	0.217	0.188	0.030	5.51	4.78	0.76
19-05-X254-XXXX	0.187	0.227	0.040	4.75	5.77	1.02
19-05-16720-XXXX	0.400	0.230	0.035	10.16	5.84	0.89
19-05-25074-XXXX	0.374	0.235	0.031	9.50	5.97	0.79
10-05-6991-XXXX	0.250	0.250	0.062	6.35	6.35	1.57
10-05-6394-XXXX	0.250	0.250	0.065	6.35	6.35	1.65
10-05-4308-XXXX	0.312	0.312	0.062	7.92	7.92	1.57
19-05-19369-XXXX	0.312	0.312	0.038	7.92	7.92	0.97
19-05-C589-XXXX	0.488	0.312	0.055	12.40	7.92	1.40
19-05-16657-XXXX	0.487	0.324	0.055	12.37	8.23	1.40
19-05-12375-XXXX	0.487	0.324	0.062	12.37	8.23	1.57
10-05-4542-XXXX	0.487	0.324	0.080	12.37	8.23	2.03
19-05-12066-XXXX	0.487	0.324	0.045	12.37	8.23	1.14
19-05-20410-XXXX	0.750	0.324	0.062	19.05	8.23	1.57
19-05-E429-XXXX	0.500	0.500	0.062	12.70	12.70	1.57
10-05-4282-XXXX	0.700	0.600	0.100	17.78	15.24	2.54
19-05-L362-XXXX	0.750	0.750	0.075	19.05	19.05	1.90

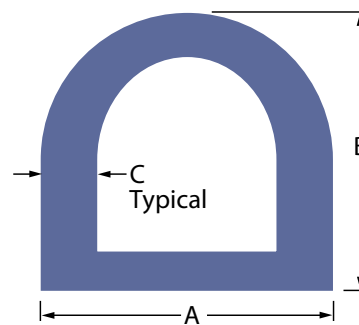

EXTRUSION

Standard Tolerances (inch)
 <0.200: ±0.005
 0.200 - 0.349: ±0.008
 0.350 - 0.500: ±0.010
 >0.500: ±3% Nom. Dim.

Most commonly selected profiles

Dimensions listed for reference only.
 Please see Chomerics drawing for revision-controlled specifications.
 Contact Chomerics Applications Engineering for groove design assistance.

(For PSA, change -05 to -20)

Note: also see Mushroom "D" profiles on page 64

Profile Description: Rectangular Strip Shape

Table 6-9: Profiles, Rectangular Strip-Shape (Sorted by "B" Dimension)

Part Number	Nominal Dimension (inch)		Nominal Dimension (mm)	
	A	B	A	B
19-07-21642-XXXX	0.188	0.031	4.78	0.79
19-07-26306-XXXX	0.625	0.032	15.88	0.81
19-07-10959-XXXX	0.870	0.032	22.10	0.81
19-07-M327-XXXX	1.000	0.032	25.40	0.081
19-07-25114-XXXX	1.300	0.032	33.02	0.81
19-07-26385-XXXX	1.500	0.032	38.10	0.81
19-07-Z499-XXXX	0.114	0.039	2.90	0.99
19-07-11206-XXXX	0.120	0.040	3.05	1.02
19-07-12675-XXXX	0.500	0.040	12.70	1.02
10-07-4272-XXXX	0.063	0.042	1.60	1.07
19-07-11081-XXXX	1.000	0.042	25.40	1.07
19-07-21881-XXXX	0.177	0.045	4.50	1.14
19-07-19506-XXXX	0.320	0.045	8.13	1.14
19-07-20218-XXXX	0.157	0.050	3.99	1.27
19-07-20362-XXXX	0.157	0.059	3.99	1.50
10-07-F743-XXXX	0.375	0.060	9.52	1.52
19-07-12959-XXXX	0.640	0.060	16.26	1.52
10-07-L525-XXXX	1.120	0.060	28.45	1.52
19-07-26267-XXXX	1.250	0.060	31.75	1.52
19-07-12949-XXXX	0.095	0.062	2.41	1.57
10-07-2981-XXXX	0.095	0.062	2.41	1.57
10-07-3225-XXXX	0.125	0.062	3.17	1.57
10-07-3047-XXXX	0.156	0.062	3.96	1.57
19-07-F463-XXXX	0.188	0.062	4.78	1.57
10-07-3226-XXXX	0.250	0.062	6.35	1.57
19-07-L463-XXXX	0.390	0.062	9.91	1.57
19-07-12200-XXXX	0.500	0.062	12.70	1.57
19-07-12958-XXXX	0.569	0.062	14.45	1.57
19-07-11294-XXXX	0.750	0.062	19.05	1.57
10-07-4483-XXXX	0.750	0.062	19.05	1.57
19-07-22989-XXXX	0.825	0.062	20.95	1.57
19-07-22989-XXXX	0.825	0.062	20.95	1.57
10-07-4523-XXXX	0.880	0.062	22.35	1.57
19-07-27623-XXXX	0.920	0.062	23.37	1.57
19-07-E431-XXXX	1.000	0.062	25.40	1.57
10-07-4538-XXXX	1.180	0.062	29.97	1.57
19-07-12961-XXXX	1.210	0.062	30.73	1.57
19-07-16941-XXXX	1.250	0.062	31.75	1.57
19-07-W391-XXXX	1.600	0.062	40.64	1.57
19-07-F067-XXXX	2.000	0.062	50.80	1.57
19-07-26620-XXXX	2.500	0.062	63.50	1.57

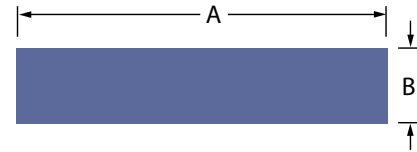

Part Number	Nominal Dimension (inch)		Nominal Dimension (mm)	
	A	B	A	B
19-07-12954-XXXX	0.255	0.063	6.48	1.60
19-07-12956-XXXX	0.508	0.063	12.90	1.60
19-07-25333-XXXX	0.768	0.067	19.51	1.70
10-07-4014-XXXX	0.120	0.075	3.05	1.90
10-07-3522-XXXX	0.500	0.075	12.70	1.90
19-07-12948-XXXX	0.085	0.085	2.16	2.16
19-07-11080-XXXX	1.000	0.090	25.40	2.29
19-07-12953-XXXX	0.188	0.093	4.78	2.36
19-07-12491-XXXX	0.500	0.093	12.70	2.36
19-07-24976-XXXX	0.625	0.093	18.88	2.36
19-07-11079-XXXX	0.780	0.100	19.81	2.54
19-07-13026-XXXX	0.188	0.125	4.78	3.17
19-07-21339-XXXX	0.250	0.125	6.35	3.17
10-07-4217-XXXX	0.500	0.125	12.70	3.17
19-07-12877-XXXX	0.620	0.125	15.75	3.17
19-07-11495-XXXX	0.880	0.125	22.35	3.17
19-07-8345-XXXX	0.980	0.125	24.89	3.17
19-07-12951-XXXX	0.126	0.126	3.20	3.20
19-07-12957-XXXX	0.564	0.127	14.33	3.23
19-07-F627-XXXX	0.219	0.156	5.56	3.96
10-07-14592-XXXX	0.438	0.188	11.13	4.78
10-07-3080-XXXX	0.500	0.188	12.70	4.78
10-07-B447-XXXX	0.500	0.250	12.70	6.35
10-07-3797-XXXX	1.000	0.250	25.40	6.35
19-07-27622-XXXX	1.190	0.250	30.23	6.35
19-07-12955-XXXX	0.330	0.305	8.38	7.75
19-07-L956-XXXX	0.875	0.312	22.22	7.92
19-07-16977-XXXX	1.250	0.500	31.75	12.70

Most commonly selected profiles

Standard Tolerances (inch)

- <0.200: ±0.005
- 0.200 - 0.349: ±0.008
- 0.350 - 0.500: ±0.010
- >0.500: ±3% Nom. Dim.

Dimensions listed for reference only.

Please see Chomerics drawing for revision-controlled specifications.

Contact Chomerics Applications Engineering for groove design assistance.

For PSA, change -07 to -20.

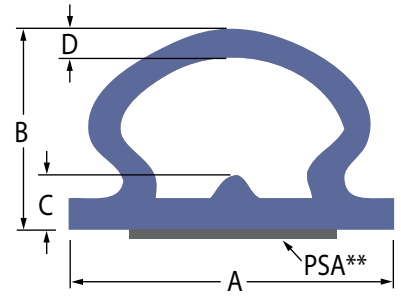

Profile Description: Mushroom D Shape

Table 6-10: Profiles, Mushroom D-Shape (Sorted by "B" Dimension)

Part Number	Nominal Dimension (inch)				Nominal Dimension (mm)				REF PSA width (inch)	Suggested Gap Range (inch)			
	A	B	C	D	A	B	C	D		Min. Gap	Nominal Gap	Max. Gap	Deflection Range
19-09-16802-XXXX	0.315	0.301	0.109	0.053	8.00	7.65	2.77	1.35	0.160	0.175	0.213	0.250	0.075
19-09-16503-XXXX	0.265	0.312	0.113	0.040	6.73	7.92	2.87	1.02	0.090	0.188	0.224	0.260	0.072
19-05-14587-XXXX	0.487	0.324	0.115	0.055	12.37	8.23	2.92	1.40	0.250	0.175	0.223	0.270	0.095
19-09-14377-XXXX	0.625	0.375	0.106	0.057	15.88	9.52	2.69	1.45	0.375	0.175	0.243	0.310	0.135
19-09-14926-XXXX	0.625	0.400	0.106	0.057	15.88	10.16	2.69	1.45	0.375	0.200	0.265	0.330	0.130
19-05-14282-XXXX	0.645	0.427	0.065	0.067	16.38	10.85	1.65	1.65	0.300	0.225	0.290	0.355	0.130
19-09-16339-XXXX	0.472	0.433	0.115	0.040	11.99	11.00	2.92	1.02	0.250	0.188	0.274	0.360	0.172
19-09-15486-XXXX	0.846	0.472	0.120	0.053	21.49	11.99	3.05	1.35	0.375	0.188	0.292	0.395	0.207
19-09-15523-XXXX	0.890	0.730	0.183	0.065	22.61	18.54	4.65	1.65	0.500	0.250	0.405	0.560	0.310

Standard Tolerances (inch)
 <0.200: ±0.005
 0.200 - 0.349: ±0.008
 0.350 - 0.500: ±0.010
 >0.500: ±3% Nom. Dim.

Most commonly selected profiles

Dimensions listed for reference only.
 Please see Chomerics drawing for revision-controlled specifications.
 *Contact Chomerics Applications Engineering for groove design assistance.
 **For optional PSA on surface "A", change the second syllable of the part number from -05 or -09 to -20. The PSA will be centered on the part.

Custom Mushroom Profiles

<p>19-09-14377-XXXX</p>	<p>19-09-14587-XXXX</p>	<p>19-09-16802-XXXX</p>	<p>19-09-15523-XXXX</p>
<p>19-09-14926-XXXX</p>	<p>19-09-15486-XXXX</p>	<p>19-09-16339-XXXX</p>	<p>19-05-14282-XXXX</p>

Dimensions shown in inches; 1 in. = 25.4 mm

EXTRUSION

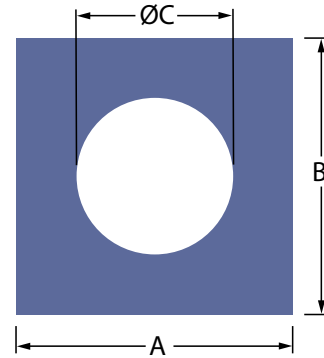

Profile Description: Hollow Rectangle Shape

Table 6-11: Profiles, Hollow Rectangle-Shape (Sorted by "B" Dimension)

Part Number	Nominal Dimension (inch)			Nominal Dimension (mm)		
	A	B	C	A	B	C
10-07-13944-XXXX	0.100	0.059	0.020	2.54	1.50	0.51
19-07-15804-XXXX	0.126	0.126	0.048	3.20	3.20	1.22
19-09-22260-XXXX*	0.500	0.280	-	12.70	7.11	-
10-07-2998-XXXX	0.305	0.330	0.125	7.75	8.38	3.17
10-07-4481-XXXX	0.375	0.375	0.188	9.52	9.52	4.78
10-07-E263-XXXX	0.500	0.500	0.250	12.70	12.70	6.35

*Profile 19-09-22260 is symmetrical hollow rectangle with 0.060 in. interior wall.

Most commonly selected profiles

Standard Tolerances (inch)

- <0.200: ± 0.005
- 0.200 - 0.349: ± 0.008
- 0.350 - 0.500: ± 0.010
- >0.500: $\pm 3\%$ Nom. Dim.

Dimensions listed for reference only.

Please see Chomerics drawing for revision-controlled specifications.

Contact Chomerics Applications Engineering for groove design assistance.

Custom Extrusions

Custom Extrusion Capabilities

As the world's leading supplier of conductive elastomer gaskets, Chomerics routinely supports its customers by producing extruded gaskets in special configurations. These range from unusual sizes in

standard shapes to highly complex designs that meet specialized shielding and environmental sealing requirements.

The following "showcase" includes representative examples of our custom extrusion capabilities. If you are interested in adapting one

of these shapes to your design, or developing an altogether new gasket design, contact our Applications Engineering Department. We welcome the opportunity to assist you.

Custom A Profiles

<p>19-09-10076-XXXX</p>	<p>19-09-10645-XXXX</p>	<p>19-09-11540-XXXX</p>	<p>19-09-12057-XXXX</p>
<p>19-09-13233-XXXX</p>	<p>19-09-14446-XXXX</p>	<p>19-09-33840-XXXX</p>	<p>19-09-20871-XXXX</p>
<p>19-09-E053-XXXX</p>	<p>19-09-F948-XXXX</p>	<p>19-09-M942-XXXX</p>	<p>19-09-X962-XXXX</p>
<p>19-09-24030-XXXX</p>	<p>19-09-24063-XXXX</p>	<p>19-09-24526-XXXX</p>	<p>19-09-26571-XXXX</p>

Dimensions shown in inches; 1 in. = 25.4 mm

EXTRUSION

Custom D Profiles

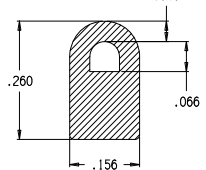
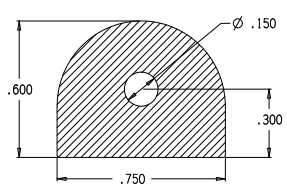
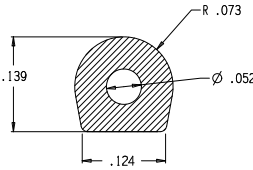
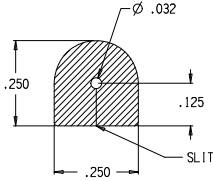
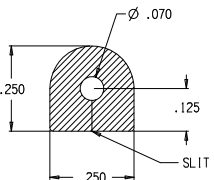
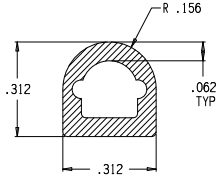
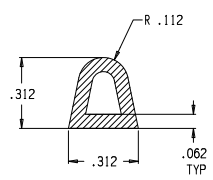
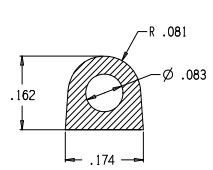
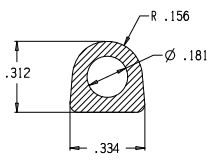
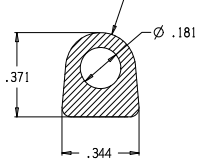
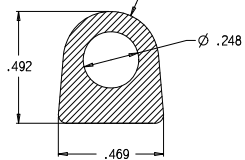
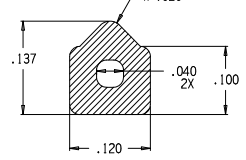
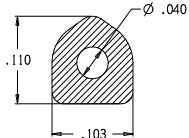
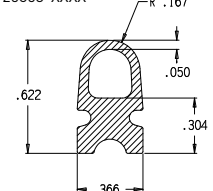
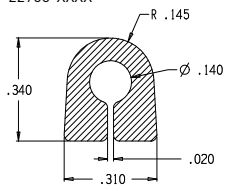
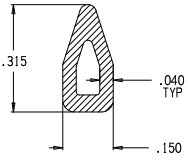
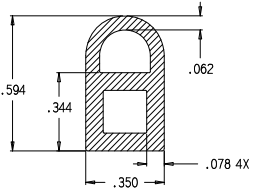
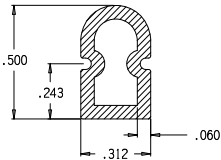
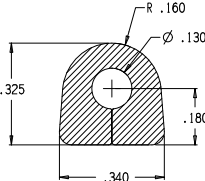
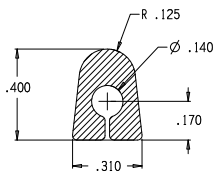
<p>10-05-10648-XXXX</p> 	<p>10-05-14081-XXXX</p> 	<p>19-09-14757-XXXX</p> 	<p>19-09-19925-XXXX</p> 
<p>19-09-19926-XXXX</p> 	<p>10-05-3369-XXXX</p> 	<p>10-05-4318-XXXX</p> 	<p>10-05-8635-XXXX</p> 
<p>19-09-B248-XXXX</p> 	<p>19-05-B250-XXXX</p> 	<p>19-05-B254-XXXX</p> 	<p>19-05-B363-XXXX</p> 
<p>19-05-L547-XXXX</p> 	<p>19-09-25853-XXXX</p> 	<p>19-09-22965-XXXX</p> 	<p>19-09-23309-XXXX</p> 
<p>19-09-23709-XXXX</p> 	<p>10-05-4035-XXXX</p> 	<p>19-09-25823-XXXX</p> 	<p>19-09-26627-XXXX</p> 

Custom P Profiles

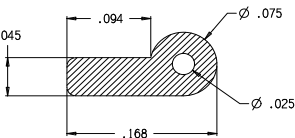
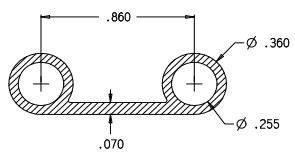
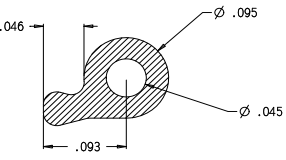
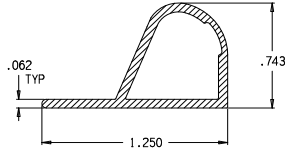
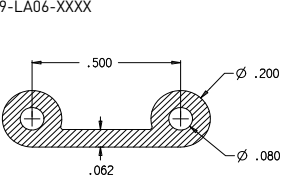
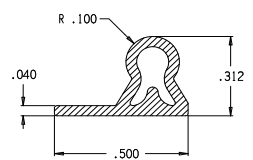
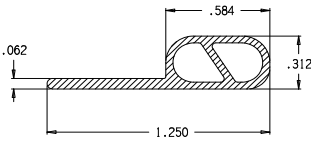
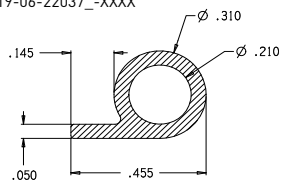
<p>19-06-11400-XXXX</p> 	<p>19-09-19944-XXXX</p> 	<p>19-09-20733-XXXX</p> 	<p>19-09-21275-XXXX</p> 
<p>19-09-LA06-XXXX</p> 	<p>19-09-22539-XXXX</p> 	<p>19-09-30385-XXXX</p> 	<p>19-06-22037-XXXX</p> 

Dimensions shown in inches; 1 in. = 25.4 mm

EXTRUSION

Custom Hat Profiles

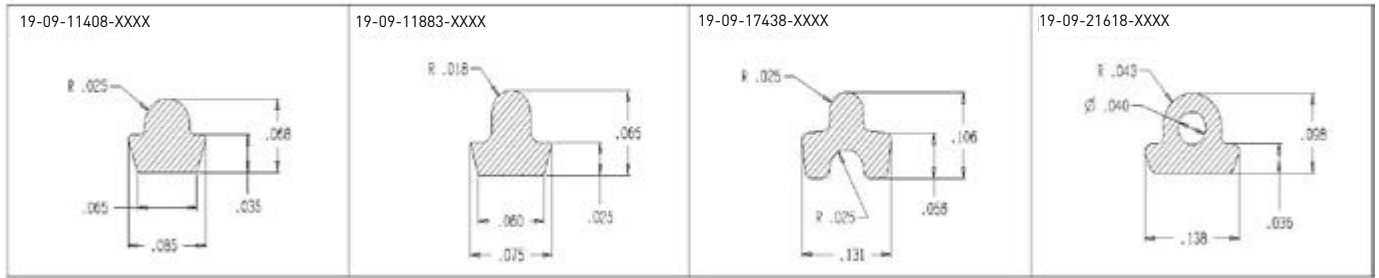

Large Custom Profiles

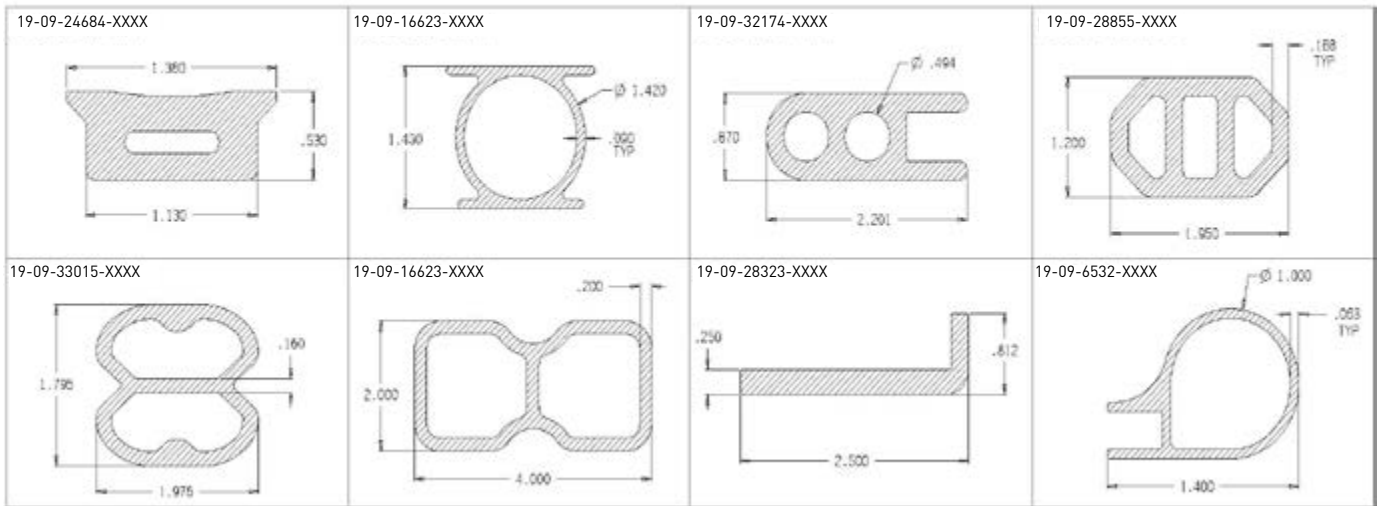

Custom Profiles

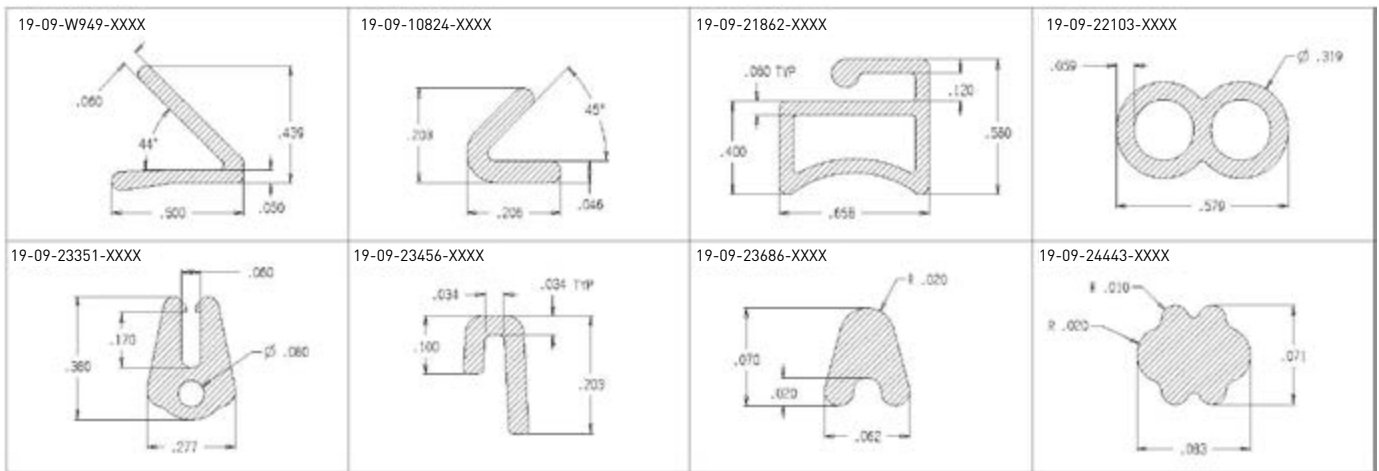

Dimensions shown in inches; 1 in. = 25.4 mm

EXTRUSION

Custom Profiles

19-09-10357-XXXX 	19-09-10843-XXXX 	19-09-10921-XXXX 	19-09-11219-XXXX
19-09-11225-XXXX 	19-08-11240-XXXX 	19-09-11434-XXXX 	19-09-11860-XXXX
19-09-12756-XXXX 	19-08-12876-XXXX 	19-09-13225-XXXX 	19-09-14182-XXXX
19-09-14350-XXXX 	19-09-14645-XXXX 	19-09-14831-XXXX 	19-09-15097-XXXX
19-09-15111-XXXX 	19-09-15142-XXXX 	19-09-15245-XXXX 	19-09-15377-XXXX
19-09-15562-XXXX 	19-09-15862-XXXX 	19-09-15937-XXXX 	19-09-16078-XXXX
19-09-16336-XXXX 	19-09-16503-XXXX 	19-09-16891-XXXX 	19-09-16961-XXXX

Dimensions shown in inches; 1 in. = 25.4 mm

Custom Profiles

<p>19-09-17276-XXXX</p>	<p>19-09-17428-XXXX</p>	<p>19-09-17429-XXXX</p>	<p>19-09-18963-XXXX</p>
<p>19-09-19022-XXXX</p>	<p>19-09-19234-XXXX</p>	<p>19-18-19561-XXXX</p>	<p>19-09-19681-XXXX</p>
<p>19-09-19880-XXXX</p>	<p>19-09-20405-XXXX</p>	<p>19-09-20670-XXXX</p>	<p>19-09-21048-XXXX</p>
<p>19-09-21717-XXXX</p>	<p>19-09-A450-XXXX</p>	<p>19-09-C032-XXXX</p>	<p>19-09-C264-XXXX</p>
<p>19-09-F158-XXXX</p>	<p>19-09-F464-XXXX</p>	<p>19-09-F676-XXXX</p>	<p>19-09-L453-XXXX</p>
<p>19-09-L524-XXXX</p>	<p>19-09-L957-XXXX</p>	<p>19-09-LB05-XXXX</p>	<p>19-09-LD89-XXXX</p>
<p>19-09-LE14-XXXX</p>	<p>19-09-LE24-XXXX</p>	<p>19-09-LF69-XXXX</p>	<p>19-09-W321-XXXX</p>

Dimensions shown in inches; 1 in. = 25.4 mm

EXTRUSION

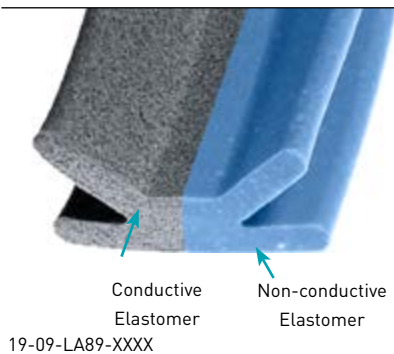
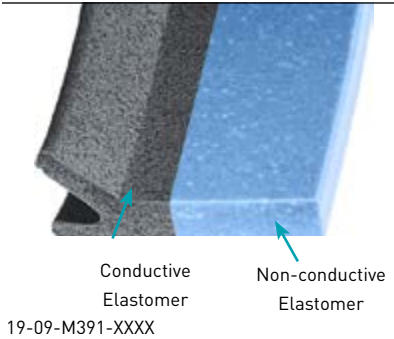
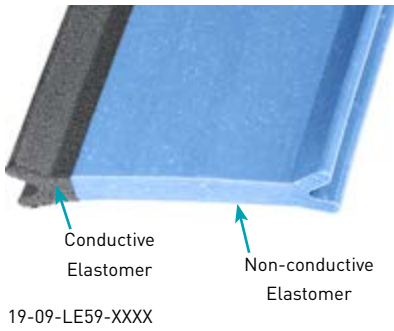

**Note: Refer to "Surface Preparation of Metallic Substrates" on page 32 for important information on proper cleaning and application.*

Co-Extruded Strips

Optimum Shielding Performance Plus Corrosion Prevention

Chomerics manufactures a dual performance extruded gasket in one simple design. By a seam vulcanization process, CHO-SEAL or CHO-SEAL conductive elastomers are extruded in parallel with non-conductive elastomers to provide EMI shielding and corrosion protection from one gasket. The outer, non-conductive gasket acts as an extra environmental seal to keep moisture away from the conductive gasket/flange interface. This prevents corrosion of the mating flange in marine or airborne environments. Co-extruded gaskets are also cost-effective, as they permit the use of existing flange designs and provide for gasket attachment via a less expensive non-conductive elastomer. A similar two gasket shielding system requires a costly double groove flange design.

Technically Superior Design

Typical examples of effective co-extruded gaskets include commercial and military communications equipment, rack mounted cabinetry, and aircraft doors and panels. These applications vary in required shielding performance. Each Chomerics co-extruded gasket is engineered in our applications laboratory to match

the geometric constraints, closure requirements and shielding performance demanded by the application.

Availability

Many of the gasket cross section shapes and sizes listed on the previous pages can also be co-extruded. Common co-extruded configurations are pictured at left. Also refer to the following pages for a selection of co-extruded shapes currently available. Contact Chomerics to assist you in material selection.

Fast, Easy Conductive Elastomer Gasket Installation with Chomerics Adhesive Tape Attachment

Chomerics has developed a unique adhesive attachment material for CHO-SEAL or CHO-SEAL conductive EMI gaskets. This non-conductive pressure-sensitive adhesive (PSA) tape is available on most extruded profiles with a flat tape attachment area, such as D-, P-, K- and rectangular cross sections.

PSA Application: Refer to page 30 for Applications detailed guidance on PSA systems.

Table 6-12: Non-Conductive Extruded Elastomer Specifications*

Non-Conductive Extruded Elastomer Specifications*				
	Test Procedure (Type of Test)	CHO-SEAL 2532	CHO-SEAL 2542	CHO-SEAL 2557
Conductive Match	-	1215/1273	1287/1298/ L6303/6503	S6305/1285/1350/ 1215/1273/6372/6502
Elastomer Binder	-	Silicone	Fluoro-Silicone	Silicone
Color	-	Black	Light Blue	Light Blue
Hardness, Shore A	ASTM D2240 (Q/C)	60±5	70±5	65±10
Specific Gravity (±0.25)	ASTM D792 (Q/C)	1.5	1.68	1.55
Tensile Strength, psi (MPa), min.	ASTM D412 (Q/C)	400 (2.76)	500 (3.45)	200 (1.38)
Elongation, % min.	ASTM D412 (Q/C)	130	65	100
Tear Strength, lb/in/ (kN/m), min.	ASTM D624 (Q/C)	35 (6.13)	30 (5.25)	35 (6.13)
*Materials used in the above chart are available to be used as Co-extrusions or bonded together with an EMI gasket.				

Dimensions shown in inches; 1 in. = 25.4 mm

Custom Co-Extruded Gaskets

Extruded in parallel, dual conductive/non-conductive gaskets provide optimum EMI shielding and corrosion protection in a single, cost-effective design. To discuss your requirements, contact our Applications Engineering Department.



Custom Co-Extruded Strips

<p>19-18-10168-XXXX</p>	<p>19-09-11771-XXXX</p>	<p>19-18-13715-XXXX</p>	<p>19-18-F775-XXXX</p>
<p>19-09-LD55-XXXX</p>	<p>19-09-LE59-XXXX</p>	<p>19-09-LH10-XXXX</p>	<p>19-18-15489-XXXX</p>
<p>19-05-F011-XXXX</p>	<p>19-09-LA89-XXXX</p>	<p>19-09-X869-XXXX</p>	<p>19-09-Z721-XXXX</p>
<p>10-09-LH17-XXXX</p>	<p>19-18-M391-XXXX</p>	<p>19-18-M635-XXXX</p>	<p>19-09-LF27-XXXX</p>
<p>19-24-12391-XXXX Combination Gasket</p>	<p>19-18-19078-XXXX</p>	<p>19-18-19247-XXXX</p>	<p>19-18-19358-XXXX</p>
<p>19-18-19495-XXXX</p>	<p>19-18-21184-XXXX</p>	<p>19-18-22999-XXXX</p>	<p>19-18-24773-XXXX</p>
<p>19-18-25990-XXXX</p>	<p>19-18-32234-XXXX</p>	<p>19-18-37817-XXXX</p>	<p>19-18-38246-XXXX</p>

Dimensions shown in inches; 1 in. = 25.4 mm

EXTRUSION

MIL-DTL-83528 Part Number Cross Reference Chart

Table 6-13: MIL-DTL-83528 Part Number Cross Reference Chart - Sorted by MIL P/N

Chomerics Part Number	MIL Part Number		Profile Shape	Chomerics Part Number	MIL Part Number		Profile Shape
	MIL P/N prefix*				MIL P/N prefix*		
10-04-6386-XXXX	M83528/001Y001		Solid O	10-07-4272-XXXX	M83528/009Y001		Rectangular
10-04-3560-XXXX	M83528/001Y002			10-07-2981-XXXX	M83528/009Y002		
10-04-2561-XXXX	M83528/001Y003			10-07-4014-XXXX	M83528/009Y003		
10-04-1687-XXXX	M83528/001Y004			10-07-3225-XXXX	M83528/009Y004		
10-04-2657-XXXX	M83528/001Y005			10-07-3047-XXXX	M83528/009Y005		
10-04-2865-XXXX	M83528/001Y006			10-07-3226-XXXX	M83528/009Y006		
10-04-1720-XXXX	M83528/001Y007			10-07-3522-XXXX	M83528/009Y007		
10-04-3077-XXXX	M83528/001Y008			10-07-4217-XXXX	M83528/009Y008		
10-04-2463-XXXX	M83528/001Y009			10-07-3080-XXXX	M83528/009Y009		
10-04-1721-XXXX	M83528/001Y010			10-07-4483-XXXX	M83528/009Y010		
19-04-F371-XXXX	M83528/001Y011			10-07-4523-XXXX	M83528/009Y011		
10-04-2864-XXXX	M83528/001Y012			10-07-3797-XXXX	M83528/009Y012		
10-04-3076-XXXX	M83528/001Y013			10-07-4538-XXXX	M83528/009Y013		
10-05-1362-XXXX	M83528/003Y001		10-08-6475-XXXX	M83528/010Y001		Channel	
10-05-3224-XXXX	M83528/003Y002		10-08-3215-XXXX	M83528/010Y002			
10-05-1363-XXXX	M83528/003Y003		10-08-4315-XXXX	M83528/010Y003			
19-05-Z586-XXXX	M83528/003Y004		10-08-3157-XXXX	M83528/010Y004			
10-05-2618-XXXX	M83528/003Y006		10-08-3253-XXXX	M83528/010Y005			
10-05-1364-XXXX	M83528/003Y007		10-08-3872-XXXX	M83528/010Y006			
10-05-1499-XXXX	M83528/003Y008		10-04-2999-XXXX	M83528/011Y001		Hollow O	
19-05-F173-XXXX	M83528/003Y009		10-04-4180-XXXX	M83528/011Y002			
10-05-1577-XXXX	M83528/003Y010		10-04-2737-XXXX	M83528/011Y003			
19-05-W469-XXXX	M83528/003Y011		10-04-3004-XXXX	M83528/011Y004			
10-05-6419-XXXX	M83528/007Y001		10-04-3122-XXXX	M83528/011Y005			
10-05-4202-XXXX	M83528/007Y002		10-04-8817-XXXX	M83528/011Y006			
10-05-4308-XXXX	M83528/007Y003		10-04-8363-XXXX	M83528/011Y007			
10-05-3369-XXXX	M83528/007Y004		10-04-8133-XXXX	M83528/011Y008			
10-05-4318-XXXX	M83528/007Y005						
10-05-4542-XXXX	M83528/007Y006						
10-05-6394-XXXX	M83528/007Y007						
10-06-3599-XXXX	M83528/008Y001						
10-06-4142-XXXX	M83528/008Y002						
10-06-3300-XXXX	M83528/008Y003						
10-06-4921-XXXX	M83528/008Y004						
10-06-5611-XXXX	M83528/008Y005						
10-06-2750-XXXX	M83528/008Y006						
10-06-8550-XXXX	M83528/008Y007						
10-06-6180-XXXX	M83528/008Y008						

* MIL part number is MIL P/N prefix with Dash # as suffix. "Y" should be replaced by applicable MIL-DTL-83528 material type (e.g., A, B, C, etc.).

Sheet Stock and Fabricated Parts

SHEET STOCK

Parker Chomerics military and commercial-grade elastomer material is available in sheet form. We are able to meet most design requirements with the standard sizes and thicknesses shown in Table 7-1.

PRESSURE SENSITIVE ADHESIVE (PSA) BACKING

All standard silicone and fluorosilicone sheets of .020 inch (0.51 mm) thickness or greater are available with a thin, acrylic, electrically conductive, pressure sensitive adhesive (PSA) backing. Fluorocarbon and EPDM sheet stock are not available with PSA. While published electrical performance specifications of the conductive elastomer materials are for materials without PSA backing, there is no appreciable effect on the gasket through flange resistance or shielding effectiveness with use of PSA. Use of PSA as an attachment method for elastomer materials is meant to aid in initial assembly operations vs. a long term means of permanent attachment.

Shelf life of the sheet stock with PSA is one year from date of manufacture. Sheet stock without adhesive has an indefinite shelf life.

PSA Application: Refer to page 30 for Applications detailed guidance on PSA systems.



CUSTOM DIE-CUT PARTS

Custom parts can be die-cut by Parker Chomerics (and our Authorized Fabricators) from any standard sheet stock. Please provide a sketch or drawing to Parker Chomerics Applications Engineering. It will be reviewed for appropriate design criteria, such as wall thickness and feature size and location. Parker Chomerics will assign a custom part number for custom die-cut parts. The custom part number will be

19-11-ZZZZZ-XXXXX

where ZZZZZ is a sequential manufacturing drawing number (assigned by Parker Chomerics), and XXXXX is the material designation (1285, L6303, etc.).

GENERAL TOLERANCES

Table 7-2 provides general tolerances for flat die-cut conductive elastomer gaskets. It is important to note that all flat die-cut and molded gaskets are subject to variation in the unrestrained condition. The use of inspection fixtures to verify conformance of finished parts is common and recommended where appropriate. Also note that "Overall Dimensions" for flat die-cut gaskets include any feature-to-feature dimensions (e.g., edge-to-edge, edge-to-hole, hole-to-hole).

STANDARD SHEET SIZE ORDERING PROCEDURE

Select the part number from Table 7-1. The last four or five digits designate the material type. For "TA" in the part number, select the desired thickness ("T" code) and adhesive option ("A" code). For custom sizes or thicknesses, part numbers will be assigned by Parker Chomerics.

Standard Sheet Stock - Product Information

Table 7-1

STANDARD SHEET STOCK SIZE							
AVAILABILITY BY THICKNESS, inches (mm)							
Part Number*	Sheet Size Inches (cm)	0.020 ±0.004 (0.51 ±0.10)	0.032 ±0.005 (0.81 ±0.13)	0.045 ±0.006 (1.14 ±0.15)	0.062 ±0.007 (1.57±0.18)	0.093 ±0.010 (2.36 ±0.25)	0.125 ±0.010 (3.18 ±0.25)
40-TA-1010-1212	10 x 10 (25.4 x 25.4)	✓	✓	✓	✓	✓	✓
40-TA-1015-1212	10 x 15 (25.4 x 38.1)	✓	✓	✓	✓	✓	✓
40-TA-1020-1212	10 x 20 (25.4 x 50.8)	✓	✓	✓	✓	✓	✓
40-TA-2020-1212	20 x 20 (50.8 x 50.8)	NA	✓	✓	✓	✓	✓
40-TA-1010-1215	10 x 10 (25.4 x 25.4)	✓	✓	✓	✓	✓	✓
40-TA-1015-1215	10 x 15 (25.4 x 38.1)	✓	✓	✓	✓	✓	✓
40-TA-1020-1215	10 x 20 (25.4 x 50.8)	✓	✓	✓	✓	✓	✓
40-TA-2020-1215	20 x 20 (50.8 x 50.8)	NA	✓	✓	✓	✓	✓
40-TA-1010-1217	10 x 10 (25.4 x 25.4)	✓	✓	✓	✓	✓	✓
40-TA-1015-1217	10 x 15 (25.4 x 38.1)	✓	✓	✓	✓	✓	✓
40-TA-1020-1217	10 x 20 (25.4 x 50.8)	✓	✓	✓	✓	✓	✓
40-TA-2020-1217	20 x 20 (50.8 x 50.8)	NA	✓	✓	✓	✓	✓
40-TA-1010-1221	10 x 10 (25.4 x 25.4)	✓	✓	✓	✓	✓	✓
40-TA-1015-1221	10 x 15 (25.4 x 38.1)	✓	✓	✓	✓	✓	✓
40-TA-1020-1221	10 x 20 (25.4 x 50.8)	✓	✓	✓	✓	✓	✓
40-TA-2020-1221	20 x 20 (50.8 x 50.8)	NA	✓	✓	✓	✓	✓
40-TA-1010-1224	10 x 10 (25.4 x 25.4)	✓	✓	✓	✓	✓	✓
40-TA-1015-1224	10 x 15 (25.4 x 38.1)	✓	✓	✓	✓	✓	✓
40-TA-1020-1224	10 x 20 (25.4 x 50.8)	✓	✓	✓	✓	✓	✓
40-TA-2020-1224	20 x 20 (50.8 x 50.8)	NA	✓	✓	✓	✓	✓
40-TA-1010-1270	10 x 10 (25.4 x 25.4)	✓	✓	✓	✓	✓	✓
40-TA-1020-1270	10 x 20 (25.4 x 50.8)	✓	✓	✓	✓	✓	✓
40-TA-2020-1270	20 x 20 (50.8 x 50.8)	NA	✓	✓	✓	✓	✓
40-TA-1010-1273	10 x 10 (25.4 x 25.4)	✓	✓	✓	✓	✓	✓
40-TA-1015-1273	10 x 15 (25.4 x 38.1)	✓	✓	✓	✓	✓	✓
40-TA-1020-1273	10 x 20 (25.4 x 50.8)	✓	✓	✓	✓	✓	✓
40-TA-2020-1273	20 x 20 (50.8 x 50.8)	NA	✓	✓	✓	✓	✓
40-TA-1010-1285	10 x 10 (25.4 x 25.4)	✓	✓	✓	✓	✓	✓
40-TA-1015-1285	10 x 15 (25.4 x 38.1)	✓	✓	✓	✓	✓	✓
40-TA-1020-1285	10 x 20 (25.4 x 50.8)	✓	✓	✓	✓	✓	✓
40-TA-2020-1285	20 x 20 (50.8 x 50.8)	NA	✓	✓	✓	✓	✓
40-TA-1010-1287	10 x 10 (25.4 x 25.4)	✓	✓	✓	✓	✓	✓
40-TA-1015-1287	10 x 15 (25.4 x 38.1)	✓	✓	✓	✓	✓	✓
40-TA-1020-1287	10 x 20 (25.4 x 50.8)	✓	✓	✓	✓	✓	✓
40-TA-2020-1287	20 x 20 (50.8 x 50.8)	NA	✓	✓	✓	✓	✓
40-TA-1010-1298	10 x 10 (25.4 x 25.4)	✓	✓	✓	✓	✓	✓
40-TA-1015-1298	10 x 15 (25.4 x 38.1)	✓	✓	✓	✓	✓	✓
40-TA-1020-1298	10 x 20 (25.4 x 50.8)	✓	✓	✓	✓	✓	✓
40-TA-2020-1298	20 x 20 (50.8 x 50.8)	NA	✓	✓	✓	✓	✓

Standard Sheet Stock - Product Information

Table 7-1 continued

STANDARD SHEET STOCK SIZE							
AVAILABILITY BY THICKNESS, inches (mm)							
Part Number*	Sheet Size Inches (cm)	0.020 ±0.004 (0.51 ±0.10)	0.032 ±0.005 (0.81 ±0.13)	0.045 ±0.006 (1.14 ±0.15)	0.062 ±0.007 (1.57±0.18)	0.093 ±0.010 (2.36 ±0.25)	0.125 ±0.010 (3.18 ±0.25)
40-TA-1010-1310	10 x 10 (25.4 x 25.4)	✓	✓	✓	✓	✓	✓
40-TA-1015-1310	10 x 15 (25.4 x 38.1)	✓	✓	✓	✓	✓	✓
40-TA-1020-1310	10 x 20 (25.4 x 50.8)	✓	✓	✓	✓	✓	✓
40-TA-2020-1310	20 x 20 (50.8 x 50.8)	NA	✓	✓	✓	✓	✓
40-TA-1010-1350	10 x 10 (25.4 x 25.4)	✓	✓	✓	✓	✓	✓
40-TA-1015-1350	10 x 15 (25.4 x 38.1)	✓	✓	✓	✓	✓	✓
40-TA-1020-1350	10 x 20 (25.4 x 50.8)	✓	✓	✓	✓	✓	✓
40-TA-2020-1350	20 x 20 (50.8 x 50.8)	NA	✓	✓	✓	✓	✓
40-TA-1010-1401	10 x 10 (25.4 x 25.4)	NA	✓	✓	✓	✓	✓
40-TA-1015-1401	10 x 15 (25.4 x 38.1)	NA	✓	✓	✓	✓	✓
40-TA-1020-1401	10 x 20 (25.4 x 50.8)	NA	✓	✓	✓	✓	✓
40-TA-2020-1401	20 x 20 (50.8 x 50.8)	NA	✓	✓	✓	✓	✓
40-T0-1010-6307	10 x 10 (25.4 x 25.4)	NA	✓	✓	✓	✓	✓
40-T0-1015-6307	10 x 15 (25.4 x 38.1)	NA	✓	✓	✓	✓	✓
40-T0-1020-6307	10 x 20 (25.4 x 50.8)	NA	✓	✓	✓	✓	✓
40-TA-1010-6330	10 x 10 (25.4 x 25.4)	NA	✓	✓	✓	✓	✓
40-TA-1015-6330	10 x 15 (25.4 x 38.1)	NA	✓	✓	✓	✓	✓
40-TA-1020-6330	10 x 20 (25.4 x 50.8)	NA	✓	✓	✓	✓	✓
40-TA-1010-6371	10 x 10 (25.4 x 25.4)	✓	✓	✓	✓	✓	✓
40-TA-1015-6371	10 x 15 (25.4 x 38.1)	✓	✓	✓	✓	✓	✓
40-TA-1020-6371	10 x 20 (25.4 x 50.8)	✓	✓	✓	✓	✓	✓
40-TA-2020-6371	20 x 20 (50.8 x 50.8)	NA	✓	✓	✓	✓	✓
40-T0-1010-6435	10 x 10 (25.4 x 25.4)	NA	✓	✓	✓	✓	✓
40-T0-1015-6435	10 x 15 (25.4 x 38.1)	NA	✓	✓	✓	✓	✓
40-T0-1020-6435	10 x 20 (25.4 x 50.8)	NA	✓	✓	✓	✓	✓
40-TA-1010-6460	10 x 10 (25.4 x 25.4)	NA	✓	✓	✓	✓	✓
40-TA-1015-6460	10 x 15 (25.4 x 38.1)	NA	✓	✓	✓	✓	✓
40-TA-1020-6460	10 x 20 (25.4 x 50.8)	NA	✓	✓	✓	✓	✓
40-TA-2020-6460	20 x 20 (50.8 x 50.8)	NA	✓	✓	✓	✓	✓
40-TA-1010-6502	10 x 10 (25.4 x 25.4)	✓	✓	✓	✓	✓	✓
40-TA-1015-6502	10 x 15 (25.4 x 38.1)	✓	✓	✓	✓	✓	✓
40-TA-1020-6502	10 x 20 (25.4 x 50.8)	✓	✓	✓	✓	✓	✓
40-TA-2020-6502	20 x 20 (50.8 x 50.8)	NA	✓	✓	✓	✓	✓
40-TA-1010-6503	10 x 10 (25.4 x 25.4)	✓	✓	✓	✓	✓	✓
40-TA-1015-6503	10 x 15 (25.4 x 38.1)	✓	✓	✓	✓	✓	✓
40-TA-1020-6503	10 x 20 (25.4 x 50.8)	✓	✓	✓	✓	✓	✓
40-TA-2020-6503	20 x 20 (50.8 x 50.8)	NA	✓	✓	✓	✓	✓

MOLDED

Standard Sheet Stock - Product Information

Table 7-1 continued

STANDARD SHEET STOCK SIZE							
AVAILABILITY BY THICKNESS, inches (mm)							
Part Number*	Sheet Size Inches (cm)	0.020 ±0.004 (0.51 ±0.10)	0.032 ±0.005 (0.81 ±0.13)	0.045 ±0.006 (1.14 ±0.15)	0.062 ±0.007 (1.57±0.18)	0.093 ±0.010 (2.36 ±0.25)	0.125 ±0.010 (3.18 ±0.25)
40-TA-1010-L6303	10 x 10 [25.4 x 25.4]	✓	✓	✓	✓	✓	✓
40-TA-1015-L6303	10 x 15 [25.4 x 38.1]	✓	✓	✓	✓	✓	✓
40-TA-1020-L6303	10 x 20 [25.4 x 50.8]	✓	✓	✓	✓	✓	✓
40-TA-2020-L6303	10 x 10 [25.4 x 25.4]	NA	✓	✓	✓	✓	✓
40-TA-1010-S6305	10 x 10 [25.4 x 25.4]	✓	✓	✓	✓	✓	✓
40-TA-1015-S6305	10 x 15 [25.4 x 38.1]	✓	✓	✓	✓	✓	✓
40-TA-1020-S6305	10 x 20 [25.4 x 50.8]	✓	✓	✓	✓	✓	✓
40-TA-2020-S6305	20 x 20 [50.8 x 50.8]	NA	✓	✓	✓	✓	✓
40-T0-1010-V6433	10 x 10 [25.4 x 25.4]	✓	✓	✓	✓	✓	✓
40-T0-1015-V6433	10 x 15 [25.4 x 38.1]	✓	✓	✓	✓	✓	✓
40-T0-1020-V6433	10 x 20 [25.4 x 50.8]	✓	✓	✓	✓	✓	✓

✓ Available

NA Not Available

*TA refers to thickness and adhesive options.

For sizes other than those shown, change 5th through 8th digits in Part Number to reflect desired up to max size (e.g., 0415 is a 4 in. x 15 in. size).

Table 7-2

Flat Cut Gaskets inches (mm)	Tolerance inches (mm)
Overall Dimensions	
≤10 (254)	±0.010 (0.25)
>10 to ≤15 (254 to 381)	±0.020 (0.51)
>15 (381)	±0.20% nom. dim.
Thickness	
0.020 (0.51)	±0.004 (0.10)
0.032 (0.81)	±0.005 (0.13)
0.045 (1.14)	±0.006 (0.15)
0.062 (1.57)	±0.007 (0.18)
0.093 (2.36)	±0.010 (0.25)
0.125 (3.18)	±0.010 (0.25)
>0.125 (3.18)	Contact Parker Chomerics Applications Engineering
Hole Diameter ±0.010 (0.25)	

THICKNESS, inch (mm)

- 1 0.020 (0.51)
- 2 0.032 (0.81)
- 3 0.062 (1.57)
- 4 0.093 (2.36)
- 5 0.125 (3.18)
- 6 0.045 (1.14)

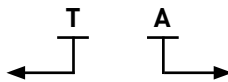

ADHESIVE (PSA)

- 0 No Adhesive
 - 1 with Electrically Conductive Adhesive Backing
- Note:** Chomerics materials 6307, 6435 and V6433 are not available with adhesive

Conductive Elastomer Connector Gaskets

Parker Chomerics provides several types of connector gaskets, such as mounting flange connectors, interfacial seals, jam nut seals, flat washers, D-subminiature rectangular connectors, O-Rings and D-Rings. All of these connector gasket are available in most of our CHO-SEAL conductive elastomer material types. For applications to continuous high temperature exposure, e.g., 160° C, CHO-SEAL 1224, 1298, or 1285 are recommended.

For those applications where exposure to fluids is a concern, fluorosilicone materials are recommended.

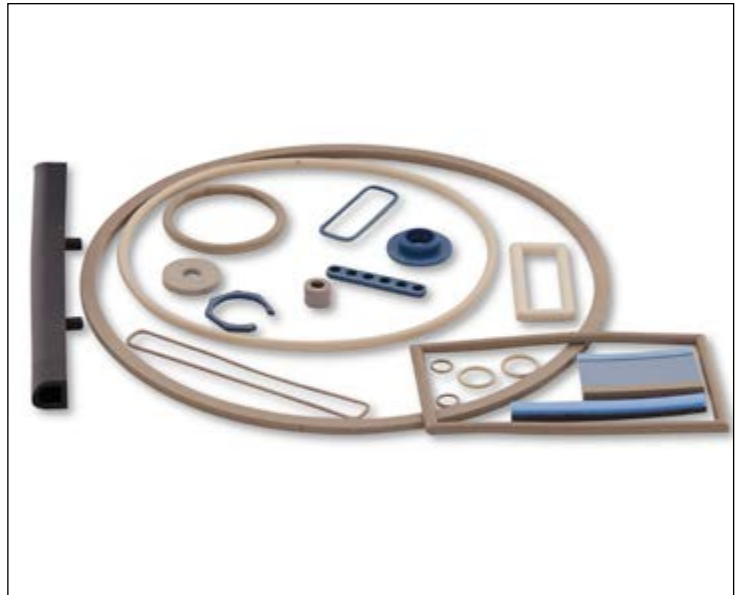

The most common connector seal materials are:

CHO-SEAL 1224, silver filled silicone

CHO-SEAL 1215, silver-plated copper filled silicone

CHO-SEAL 1285, silver-plated aluminum filled silicone

CHO-SEAL 6502, nickel-plated aluminum filled silicone

CHO-SEAL 1298, silver-plated aluminum filled fluorosilicone

CHO-SEAL 6503, nickel-plated aluminum filled fluorosilicone

CHO-SEAL L6303, nickel-plated graphite filled fluorosilicone

Mounting Flange EMI Gaskets

MOUNTING FLANGE EMI GASKETS

Parker Chomerics die-cut CHO-SEAL gaskets provide EMI shielding and environmental sealing when inserted between a connector flange and a mounting bulkhead. The gaskets described in this section are designed for use with MIL-C-83723, MIL-C-5015, MIL-C-26482, MIL-C-38999 and MIL-C-81511 connectors. They are interchangeable with non-conductive gaskets.

In addition to standard sizes and configurations listed in Table 7-3, connector gaskets and ground planes can be custom designed.

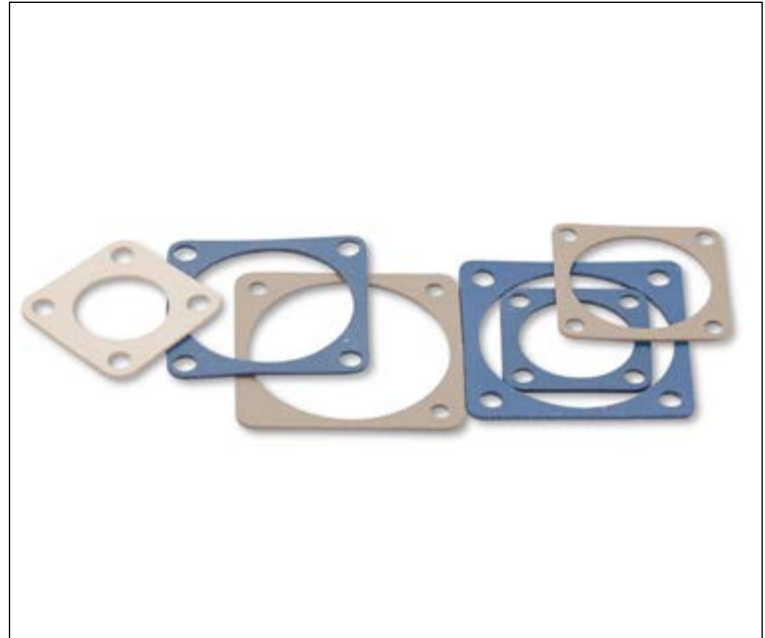

ORDERING PROCEDURE

Standard Sizes: Using Table 7-3, construct the appropriate part number as illustrated below. For Custom Gaskets: Drawings must be supplied. Part numbers will be assigned by Parker Chomerics.

Mounting Flange Gasket - Product Information

ORDERING PROCEDURE

Standard Sizes: Using Table 7-3, construct the appropriate part number as illustrated below. For Custom Gaskets: Drawings must be supplied. Part numbers will be assigned by Parker Chomerics.

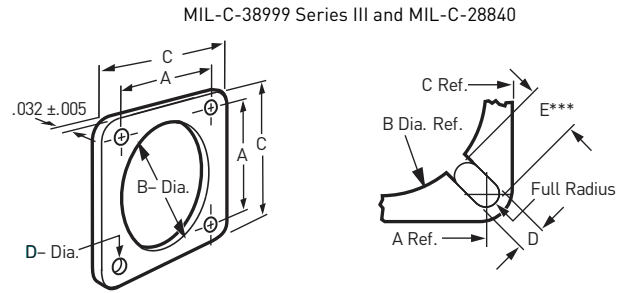
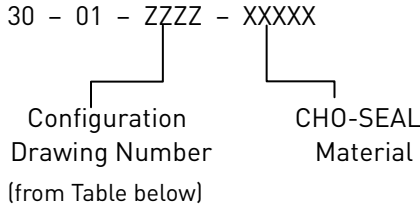

Table 7-3: Mounting Flange EMI Gaskets

Shell Size		Configuration Drawing No. ZZZZ							Dimensions inches (mm)					
No	Letter	MIL-C-38999 Series				MIL-C-81511 Series	MIL-C-28840 Series	MIL-C-5015 C-83723 NAS-1599 MIL-C-26482	MIL P/N: M83528/004X-[]	A	B	C	D	E***
		I	II	III	IV					±0.010 (0.25)	+0.020 (0.51) -0.000	±0.015 (0.38)	±0.010 (0.25)	±0.010 (0.25)
6								1946*	001	0.469 (11.91)	0.375 (9.53)	0.738 (18.75)	0.141 (3.58)	
8		1947		√					001	0.594 (15.09)	0.630 (16.00)	0.840 (21.34)	0.135 (3.43)	
						4690			003	0.594 (15.09)	0.568 (14.43)	0.812 (20.62)	0.125 (3.18)	
9		1949	√					1948	004	0.594 (15.09)	0.500 (12.70)	0.875 (22.23)	0.156 (3.96)	
	A	C646			√				NA	0.719 (18.26)	0.750 (19.05)	0.965 (24.51)	0.135 (3.43)	0.222 (5.64)
10		1949		√					005	0.719 (18.26)	0.750 (19.05)	0.965 (24.51)	0.135 (3.43)	
						4691			006	0.719 (18.26)	0.680 (17.27)	0.937 (23.80)	0.125 (3.18)	
	(S/SL)						1950		007	0.719 (18.26)	0.625 (15.88)	1.000 (25.40)	0.156 (3.96)	
11		6961	√			√			008	0.812 (20.62)	0.875 (22.23)	1.060 (26.92)	0.141 (3.58)	
	B	C647			√				NA	0.812 (20.62)	0.875 (22.23)	1.060 (26.92)	0.141 (3.58)	0.206 (5.23)
	A						C637		NA	0.750 (19.05)	0.875 (22.23)	1.046 (26.57)	0.141 (3.58)	0.163 (4.14)
12		6961		√					008	0.812 (20.62)	0.875 (22.23)	1.060 (26.92)	0.141 (3.58)	
	(S/SL)						1951		009	0.813 (20.65)	0.750 (19.05)	1.094 (27.79)	0.156 (3.96)	
13		1953	√			√			010	0.906 (23.01)	1.005 (25.53)	1.153 (29.29)	0.135 (3.43)	
	C	C648			√				NA	0.906 (23.01)	1.000 (25.40)	1.156 (29.36)	0.141 (3.58)	0.206 (5.23)
	B						C638		NA	0.843 (21.41)	1.000 (25.40)	1.156 (29.36)	0.141 (3.58)	0.167 (4.24)
14		1953		√					010	0.906 (23.01)	1.005 (25.53)	1.153 (29.29)	0.135 (3.43)	
						4692			011	0.906 (23.01)	0.938 (23.83)	1.125 (28.58)	0.125 (3.18)	
	(S)						1952		012	0.906 (23.01)	0.875 (22.23)	1.188 (30.18)	0.156 (3.96)	
15		1955	√			√			013	0.969 (24.61)	1.135 (28.83)	1.258 (31.95)	0.156 (3.96)	
	D	C649			√				NA	0.969 (24.61)	1.135 (28.83)	1.258 (31.95)	0.156 (3.96)	0.206 (5.23)
	C						C639		NA	0.968 (24.59)	1.187 (30.15)	1.281 (32.54)	0.141 (3.58)	0.161 (4.09)

√ Available in series designated.
 * Shell size 6 not specified in MIL-C-5015
 ** Shell size 28-48 specified in MIL-C-5015.
 *** For dimension E, hole is slotted through to B diameter.

*"X" should be replaced by applicable MIL-DTL-83528 material type (e.g. A, B, C, etc.). MIL-DTL-83528 dash number should be inserted (without parentheses) at end of MIL P/N.

Note: Refer to Chomerics Conductive Elastomer EMI Gaskets Molded and Extruded Materials Selector Guide for details.

MOLDED

Mounting Flange Gasket - Product Information

ORDERING PROCEDURE

Standard Sizes: Using Table 7-3, construct the appropriate part number as illustrated below. For Custom Gaskets: Drawings must be supplied. Part numbers will be assigned by Parker Chomerics.

30 - 01 - ZZZZ - XXXXX

Configuration
Drawing Number
(from Table below)

CHO-SEAL
Material

MIL-C-38999 Series III and MIL-C-28840

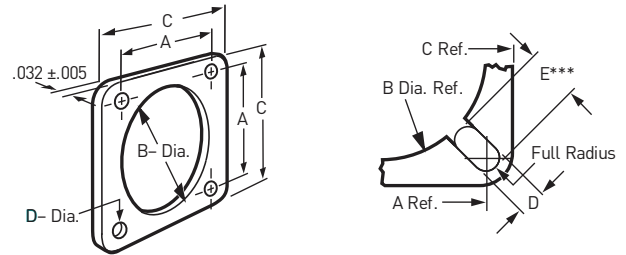

Table 7-3: Mounting Flange EMI Gaskets *continued*

Shell Size		Configuration Drawing No. ZZZZ							Dimensions inches (mm)					
No	Letter	MIL-C-38999 Series				MIL-C-81511 Series	MIL-C-28840 Series	MIL-C-5015 C-83723 NAS-1599 MIL-C-26482	MIL P/N: M83528/004X'-()	A	B	C	D	E***
		I	II	III	IV					±0.010 (0.25)	+0.020 (0.51) -0.000	±0.015 (0.38)	±0.010 (0.25)	±0.010 (0.25)
16		1955		√				013	0.969 [24.61]	1.135 [28.83]	1.258 [31.95]	0.156 [3.96]		
						4693		014	0.969 [24.61]	1.063 [27.00]	1.250 [31.75]	0.125 [3.18]		
	(S)						1954	015	0.969 [24.61]	1.000 [25.40]	1.281 [32.54]	0.156 [3.96]		
17		1957	√		√			016	1.062 [26.97]	1.260 [32.00]	1.351 [34.32]	0.156 [3.96]		
	E	C650			√			NA	1.062 [26.97]	1.260 [32.00]	1.351 [34.32]	0.156 [3.96]	0.222 [5.64]	
	D						C640	NA	1.015 [25.78]	1.250 [31.75]	1.406 [35.71]	0.141 [3.58]	0.163 [4.14]	
18	(S)	1957		√				016	1.062 [26.97]	1.260 [32.00]	1.351 [34.32]	0.156 [3.96]		
						4694		017	1.062 [26.97]	1.189 [30.20]	1.343 [34.11]	0.125 [3.18]		
							1956	018	1.062 [26.97]	1.135 [28.83]	1.375 [34.93]	0.156 [3.96]		
19		6962	√		√			019	1.156 [29.36]	1.375 [34.93]	1.500 [38.10]	0.141 [3.58]		
	F	C651			√			NA	1.156 [29.36]	1.375 [34.93]	1.500 [38.10]	0.141 [3.58]	0.206 [5.23]	
	E						C641	NA	1.140 [28.96]	1.437 [36.50]	1.531 [38.89]	0.141 [3.58]	0.158 [4.01]	
20		6962						019	1.156 [29.36]	1.375 [34.93]	1.500 [38.10]	0.141 [3.58]		
				√		4695		020	1.156 [29.36]	1.312 [33.32]	1.467 [37.26]	0.125 [3.18]		
							1958	021	1.156 [29.36]	1.250 [31.75]	1.500 [38.10]	0.172 [4.37]		
21		6963	√		√			022	1.250 [31.75]	1.500 [38.10]	1.625 [41.28]	0.141 [3.58]		
	G	C652			√			NA	1.250 [31.75]	1.500 [38.10]	1.625 [41.28]	0.141 [3.58]	0.206 [5.23]	
22		6963		√				022	1.250 [31.75]	1.500 [38.10]	1.625 [41.28]	0.141 [3.58]		
						4696		023	1.250 [31.75]	1.437 [36.50]	1.562 [39.67]	0.125 [3.18]		
							1959	024	1.250 [31.75]	1.375 [34.93]	1.625 [41.28]	0.172 [4.37]		
23		6964	√		√			025	1.375 [34.93]	1.625 [41.28]	1.750 [44.45]	0.172 [4.37]		
	H	C653			√			NA	1.375 [34.93]	1.625 [41.28]	1.750 [44.45]	0.172 [4.37]	0.259 [6.58]	
	F						C642	NA	1.281 [32.54]	1.625 [41.28]	1.750 [44.45]	0.141 [3.58]	0.164 [4.17]	

√ Available in series designated.

* Shell size 6 not specified in MIL-C-5015

** Shell size 28-48 specified in MIL-C-5015.

*** For dimension E, hole is slotted through to B diameter.

* "X" should be replaced by applicable MIL-DTL-83528 material type (e.g. A, B, C, etc.).

MIL-DTL-83528 dash number should be inserted (without parentheses) at end of MIL P/N.

Note: Refer to Chomerics Conductive Elastomer EMI Gaskets Molded and Extruded Materials Selector Guide for details.

Mounting Flange Gasket - Product Information

ORDERING PROCEDURE

Standard Sizes: Using Table 7-3, construct the appropriate part number as illustrated below. For Custom Gaskets: Drawings must be supplied. Part numbers will be assigned by Parker Chomerics.

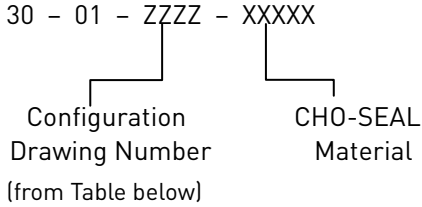

MIL-C-38999 Series III and MIL-C-28840

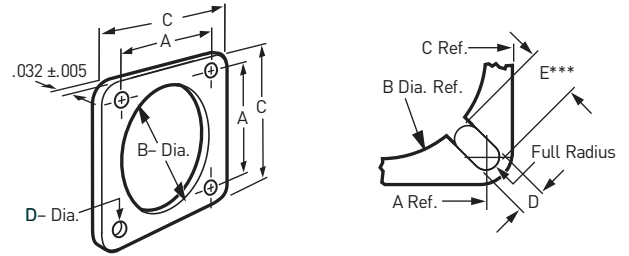

Table 7-3: Mounting Flange EMI Gaskets *continued*

Shell Size		Configuration Drawing No. ZZZZ							Dimensions inches (mm)					
No	Letter	MIL-C-38999 Series				MIL-C-81511 Series	MIL-C-28840 Series	MIL-C-5015 C-83723 NAS-1599 MIL-C-26482	MIL P/N: M83528/004X-()	A	B	C	D	E***
		I	II	III	IV					±0.010 (0.25)	+0.020 (0.51) -0.000	±0.015 (0.38)	±0.010 (0.25)	±0.010 (0.25)
24		6964		√				025	1.375 (34.93)	1.625 (41.28)	1.750 (44.45)	0.172 (4.37)		
						4697		026	1.375 (34.93)	1.563 (39.710)	1.703 (43.26)	0.152 (3.86)		
							1960	027	1.375 (34.93)	1.500 (38.10)	1.750 (44.45)	0.203 (5.16)		
25		6965	√					028	1.500 (38.10)	1.750 (44.45)	1.875 (47.63)	0.172 (4.37)		
	J	C654			√			NA	1.500 (38.10)	1.750 (44.45)	1.875 (47.63)	0.172 (4.37)	0.259 (6.58)	
	G						C643	NA	1.392 (35.36)	1.750 (44.45)	1.843 (46.81)	0.172 (4.37)	0.195 (4.95)	
28**							1961	029	1.562 (39.67)	1.750 (44.45)	2.000 (50.80)	0.203 (5.16)		
29	H						C644	NA	1.568 (39.83)	2.000 (50.80)	2.171 (55.14)	0.172 (4.37)	0.195 (4.95)	
32**							1962	030	1.750 (44.45)	2.000 (50.80)	2.250 (57.15)	0.219 (5.56)		
33	J						C645	NA	1.734 (44.04)	2.187 (55.55)	2.356 (59.84)	0.203 (5.16)	0.234 (5.94)	
36**							1963	031	1.938 (49.23)	2.250 (57.15)	2.500 (63.50)	0.219 (5.56)		
40**							1964	032	2.188 (55.58)	2.500 (63.50)	2.750 (69.85)	0.219 (5.56)		
44**							1965	033	2.375 (60.33)	2.781 (70.64)	3.000 (76.20)	0.219 (5.56)		
48**							1966	034	2.625 (66.68)	3.031 (76.99)	3.250 (82.55)	0.219 (5.56)		

√ Available in series designated.
 * Shell size 6 not specified in MIL-C-5015
 ** Shell size 28-48 specified in MIL-C-5015.
 *** For dimension E, hole is slotted through to B diameter.

+ "X" should be replaced by applicable MIL-DTL-83528 material type (e.g. A, B, C, etc.).
 MIL-DTL-83528 dash number should be inserted (without parentheses) at end of MIL P/N.
 Note: Refer to Chomerics Conductive Elastomer EMI Gaskets Molded and Extruded Materials Selector Guide for details.

MOLDED

Conductive Elastomer D-Subminiature EMI Gaskets

D-SUBMINIATURE RECTANGULAR GASKETS

Subminiature-D style gaskets are used to provide EMI shielding and environmental sealing between connector flanges and their mating surfaces. Parker Chomerics offers these gaskets in a complement of shell sizes from 9 to 50 pin and in a range of CHO-SEAL materials. Table 7-4 includes dimensions and tolerances.

ORDERING PROCEDURE

Table 7-4 provides general tolerances for D-Subminiature EMI seals. Select the part number from Table 7-4.

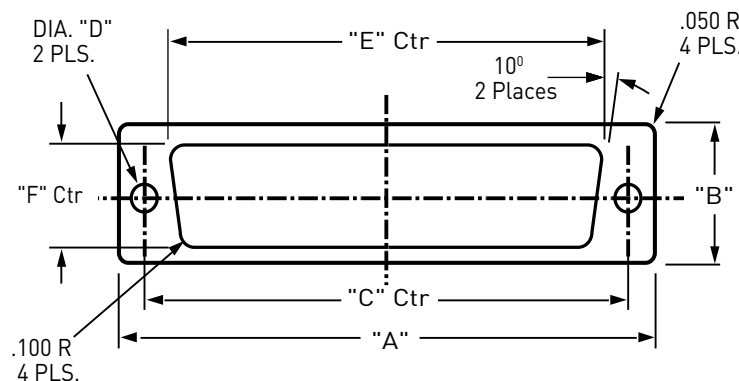

Table 7-4: D-Subminiature Gaskets

D-SUBMINIATURE GASKETS					
Dimension Tolerances inches (mm)	Shell Size inches (mm)				
	9 PIN	15 PIN	25 PIN	37 PIN	50 PIN
"A" Overall Length ± 0.15 (0.38)	1.213 (30.81)	1.556 (39.52)	2.087 (53.01)	2.729 (69.32)	2.635 (66.93)
"B" Overall Width ± 0.15 (0.38)	0.594 (15.09)	0.600 (15.24)	0.594 (15.09)	0.594 (15.09)	0.605 (15.37)
"C" Hole to Hole ± 0.10 (0.25)	0.984 (25.0)	1.312 (33.32)	1.852 (47.04)	2.500 (63.50)	2.406 (61.11)
"D" Hole Diameter ± 0.10 (0.25)	0.120 (3.05)	0.130 (3.30)	0.120 (3.05)	0.120 (3.05)	0.120 (3.05)
"E" Major Cutout Length ± 0.15 (0.38)	0.697 (17.70)	1.080 (27.43)	1.583 (40.21)	2.231 (56.67)	2.109 (53.57)
"F" Cutout Width ± 0.10 (0.25)	0.360 (9.14)	0.370 (9.40)	0.378 (9.60)	0.378 (9.60)	0.466 (11.84)
Cutout Angle Typical	10°	10°	10°	10°	10°
Chomerics Part Number*	30-TT-A779-XXXXX	30-TT-A959-XXXXX	30-TT-A780-XXXXX	30-TT-A781-XXXXX	30-TT-LF19-XXXXX

* Replace "TT" with "01" [0.032 \pm 0.005 in. (0.81 \pm 0.127 mm) thick]; or "06" [0.062 \pm 0.007 in. (1.57 \pm 0.178 mm) thick].

-XXXXX designates material (1215, 1285, etc). Refer to Chomerics Conductive Elastomer EMI Gaskets Molded and Extruded Materials Selector Guide for details.



Conductive Elastomer Interfacial EMI Seals

INTERFACIAL EMI SEALS

The main mating joint of environment-resistant MS connectors is normally provided with a rubber packing ring (MIL-C-26482) or washer (MIL-C-5015) to seal moisture from the pin area. CHO-SEAL gaskets are interchangeable with these packing/washers and provide EMI shielding in addition to sealing.

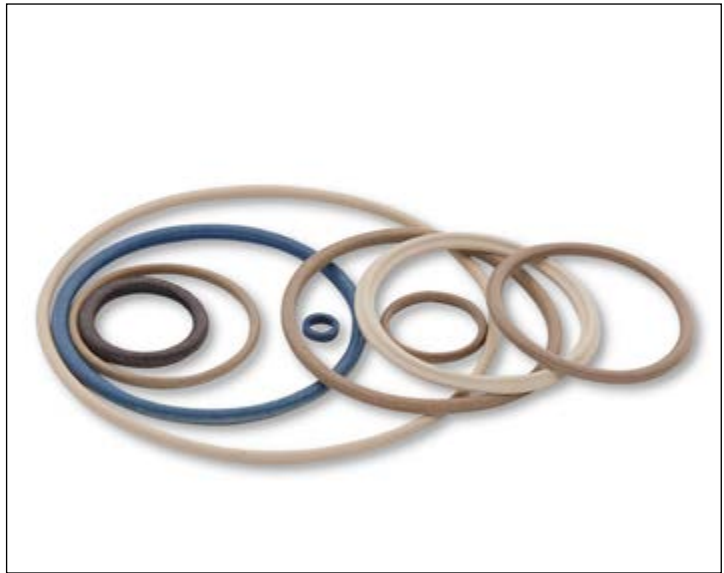

ORDERING PROCEDURE

Select the part number from Table 7-5. Table 7-6 provides general tolerances for interfacial EMI seals.

Interfacial EMI Seals - Product Information

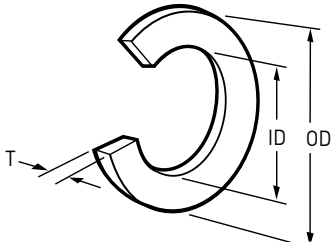

Table 7-6: Interfacial EMI Seals Tolerances

DIMENSIONS inches (mm)	TOLERANCES inches (mm)
ID, OD	
≤0.500 (12.70)	±0.005 (0.13)
0.501-1.500 (12.70-38.10)	±0.010 (0.25)
1.501-2.000 (38.10-50.80)	±0.015 (0.38)
Thickness (T)	
0.032 (0.81)	±0.005 (0.13)
0.045 (1.14)	±0.006 (0.15)
0.075 (1.91)	±0.007 (0.18)

Table 7-5: Interfacial EMI Seals

INTERFACIAL EMI SEALS					
Shell Size	Part Number*		Nominal Dimensions inches (mm)		
	MIL-C-26482	MIL-C-5015	ID	OD	T
8	30-02-2041-XXXXX		0.319 (8.10)	0.422 (11.23)	0.075 (1.91)
		30-02-2050-XXXXX	0.328 (8.33)	0.391 (9.93)	0.032 (0.81)
10	30-02-2042-XXXXX		0.447 (11.35)	0.550 (13.97)	0.075 (1.91)
10S SL		30-02-2051-XXXXX	0.406 (10.31)	0.469 (11.91)	0.032 (0.81)
12	30-02-2043-XXXXX		0.547 (13.89)	0.703 (17.86)	0.075 (1.91)
12 12 S		30-02-2052-XXXX	0.531 (13.49)	0.594 (15.09)	0.031 (0.79)
14	30-02-2044-XXXXX		0.671 (17.04)	0.828 (21.03)	0.075 (1.91)
14 14S		30-02-2053-XXXXX	0.641 (16.28)	0.703 (17.86)	0.032 (0.81)
16	30-02-2045-XXXXX		0.797 (20.24)	0.953 (24.21)	0.075 (1.91)
16 16S		30-02-2054-XXXXX	0.781 (19.84)	0.844 (21.44)	0.032 (0.81)
18	30-02-2046-XXXXX		0.891 (22.63)	1.047 (26.59)	0.075 (1.91)
		30-02-2055-XXXXX	0.891 (22.63)	0.953 (24.21)	0.032 (0.81)
20	30-02-2047-XXXXX		1.039 (26.39)	1.172 (29.77)	0.075 (1.91)
		30-02-2056-XXXXX	0.984 (24.99)	1.047 (26.59)	0.032 (0.81)
22	30-02-2048-XXXXX		1.141 (28.98)	1.297 (32.94)	0.075 (1.91)
		30-02-2057-XXXXX	1.109 (28.17)	1.172 (29.77)	0.032 (0.81)
24	30-02-2049-XXXXX		1.266 (32.16)	1.422 (36.12)	0.075 (1.91)
		30-02-2058-XXXXX	1.219 (30.96)	1.281 (32.54)	0.032 (0.81)
28		30-02-2059-XXXXX	1.455 (36.96)	1.547 (39.29)	0.045 (1.14)
32		30-02-2060-XXXXX	1.672 (42.47)	1.766 (44.86)	0.045 (1.14)
36		30-02-2061-XXXXX	1.891 (48.03)	1.984 (50.39)	0.045 (1.14)

* -XXXXX designates material (1215, 1285, etc). Refer to Chomerics Conductive Elastomer EMI Gaskets Molded and Extruded Materials Selector Guide for details.

Conductive Elastomer Waveguide Gaskets



WAVEGUIDE GASKETS

Parker Chomerics offers a selection of EMI gasket materials that provide effective EMI shielding and pressure sealing for choke, cover and contact flanges. Parker Chomerics waveguide gaskets ensure low insertion loss, low flange leakage, maximum heat transfer and minimum out gassing. Made from CHO-SEAL 1239 and 1212 conductive elastomers, the gaskets are reusable and will not scar flanges.

Cover flange and flat contact flange gaskets are die-cut from silver-plated copper filled silicone CHO-SEAL 1239 sheet stock 0.027 in. (0.69 mm) thick, ± 0.005 in. (0.13 mm). Containing an expanded metal reinforcement to eliminate cold flow, these gaskets can be supplied with a slightly raised lip around the iris opening for high-pressure, high-power applications.

Choke flange and grooved contact flange gaskets are molded from CHO-SEAL 1212 silver-filled silicone elastomer material, and are available with O- or D-cross sections. Properties of CHO-SEAL 1212 and 1239 materials are shown in Table 7-7. For applications in outdoor environments, contact Parker Chomerics Applications Engineering to discuss other materials, e.g., CHO-SEAL 1285 or 6502.

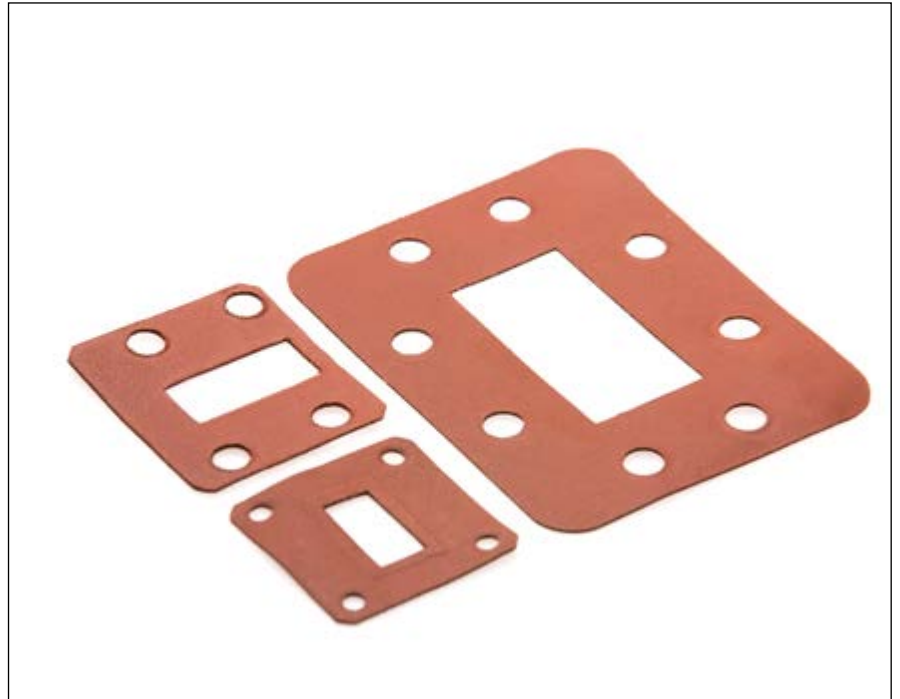

STANDARD WAVEGUIDE GASKETS

The gaskets listed in the following tables will fit the standard UG, CPR, and CMR flanges shown. The number 1 through 6 listed in the "gasket configuration" column of the tables indicate the style of gasket, as follows:

- 1 - Die-Cut rectangular
- 2 - Die-Cut circular
- 3 - Molded rectangular, with "O" cross section
- 4 - Molded circular, with "O" cross section [O-rings]
- 5 - Molded circular, with "D" cross section [D-rings]
- 6 - Molded rectangular, with "D" cross section

Gaskets can also be custom designed to meet special requirements or less frequently used waveguide sizes (from WR 10 to WR 2300) and double-ridged waveguide.

Waveguide Gasket - Product Information

Table 7-7

SPECIFICATIONS			CHO-SEAL 1212	CHO-SEAL 1239	
Type (Ref: MIL-DTL-83528)			K	G	
Volume Resistivity ohm-cm, max) as supplied (without pressure-sensitive adhesive)			0.005	0.007	
Hardness (Shore A \pm 7)			85	80	
Specific Gravity			3.5 \pm 0.45	4.75 \pm 0.75	
Tensile Strength, psi (Mpa), min.			400 (2.76)	600 (4.14)	
Elongation (percent, min/max)			100 / 300	20 / NA	
Tear Strength, lb/in. (kN/m), min.			40 (7.00)	70 (12.25)	
Compression Set, 70 hrs. @ 100°C, % max.			35	Not Tested	
Low Temperature Flex, TR10, °C, min.			-45	Not Tested	
Maximum Continuous Use Temperature, °C			125	125	
Shielding Effectiveness	200 kHz (H Field)	dB, min.	70	70	
	100 MHz (E Field)		120	110	
	500 MHz (E Field)		120	110	
	2 GHz (Plane Wave)		120	110	
	10 GHz (Plane Wave)		120	110	
Electrical Stability	Heat Aging	ohm-cm, max.	0.010	0.010	
	Vibration Resistance		During	0.010	0.007
			After	0.005	NA
	Post Tensile Set Volume Resistivity		0.010	NA	
EMP Survivability (kA per in. perimeter)			>0.9	>0.9	

NA = Not Applicable

Typical materials shown here, contact Parker Chomerics Applications Engineering for others.

ORDERING PROCEDURE

For standard gaskets, select the part number from Tables 7-8 thru 7-14. For custom configurations, gasket and waveguide flange drawings must be provided, and part numbers will be assigned by Parker Chomerics.

Waveguide Gasket - Product Information

Refer to Tables 7-9 to 7-14 on the following pages for Waveguide Gasket dimensions.

Table 7-8 Use Table 7-8 to select part numbers.

WAVEGUIDE GASKETS										
Frequency Range (GHz)	Band	EIA Waveguide Size	JAN Designation	Flange Description			Flange Type	Gasket Configuration*	Chomerics Part Number	Mil P/N: ¹ M83528/ 013 []-()
				UG	CPR	CMR				
26.5 → 40.0	Ka	WR28	RG-96/U (Silver)	UG-599/U			Cover	1	20-01-5000-1239**	[G]-[001]
				UG-600A/U			Choke	5	20-02-6510-1212	[K]-[002]
18.0 → 26.5	K	WR42	RG-53/U (Brass) RG-121/U (Aluminum)	UG-595/U UG-597/U			Cover	1	20-01-5005-1239**	[G]-[003]
				UG-596A/U UG-598A/U			Choke	5	20-02-6515-1212	[K]-[004]
12.4 → 18.0	Ku	WR62	RG-91/U (Brass) RG-107/U (Silver)	UG-419/U			Cover	1	20-01-5010-1239**	[G]-[005]
				UG-541A/U			Choke	5	20-02-6520-1212	[K]-[006]
10.0 → 15.0		WR75					Cover	1	20-11-1683-1239 20-02-6525-1212 19-00-12349-1212	[G]-[007]
							Choke	5		[K]-[008]
							Choke	4		
8.2 → 12.4	X	WR90	RG-52/U (Brass) RG-67/U (Aluminum)	UG-39/U UG-135/U			Cover	1	20-11-5015-1239	[G]-[009]
				UG-1736/U UG-1737/U	CPR-90F		Flat Contact	1	20-01-5115-1239**	[G]-[010]
				UG-136A/U UG-40A/U			Choke	5	20-02-6531-1212	[K]-[011]
				UG-136B/U UG-40B/U			Choke	5	20-02-6530-1212	[K]-[012]
				UG-1360/U UG-1361/U	CPR-90G		Contact	3	20-03-6630-1212	[K]-[013]
7.0 → 11.0		WR102		UG-149A/U			Choke	5	20-02-6535-1212	[K]-[014]
7.05 → 10.0	X ₁	WR112	RG-51/U (Brass) RG-68/U (Aluminum)	UG-51/U UG-138/U			Cover	1	20-11-5020-1239	[G]-[015]
				UG-1734/U UG-1735/U	CPR-112F		Flat Contact	1	20-01-5120-1239**	[G]-[016]
				UG-52B/U UG-137B/U			Choke	5	20-02-6540-1212	[K]-[017]
				UG-1358/U UG-1359/U	CPR-112G CPR-112G/F		Contact Choke/Flat	3 6	20-03-6635-1212 20-03-3686-1212	[K]-[018] —
5.85 → 8.2	X ₀	WR137	RG-50/U (Brass) RG-106/U (Aluminum)	UG-344/U UG-441/U			Cover	2	20-11-5025-1239	[G]-[019]
				UG-1732/U UG-1733/U	CPR-137F		Flat Contact	1	20-01-5125-1239**	[G]-[020]
						CMR-137	Flat Contact	1	20-01-5225-1239**	[G]-[021]
				UG-343B/U UG-440B/U			Choke	4	20-02-6545-1212	[K]-[022]
				UG-1356/U UG-1357/U	CPR-137G CPR-137G/F		Contact Choke/Flat	3 6	20-03-6645-1212 20-03-3731-1212	[K]-[023] —

* Number corresponds to configuration type, Tables 7-9 to 7-14

** This gasket will seal a maximum pressure of 20 psi. For systems pressurized above this limit, a high-pressure (raised-lip) version is available. To specify, change 3rd digit in Part Number from 0 to 1.

¹ Letter in bracket is MIL-DTL-83528 material type (G or K). Number in parentheses is MIL-DTL-83528 dash number. Insert them (without brackets or parentheses) to complete MIL P/N.

¹¹ Modified "O" cross section

¹¹¹ Modified "D" cross section

MOLDED

Waveguide Gasket - Product Information

Table 7-8 (continued)

WAVEGUIDE GASKETS										
Frequency Range (GHz)	Band	EIA Waveguide Size	JAN Designation	Flange Description			Flange Type	Gasket Configuration*	Chomerics Part Number	Mil P/N: [†] M83528/ 013 []-()
				UG	CPR	CMR				
4.9 → 7.05		WR159		UG-1730/U	CPR-159F		Flat Contact	1	20-01-5130-1239**	[G]-(024)
				UG-1731/U						
					CPR-159G		Flat Contact	1	20-01-5230-1239**	[G]-(025)
3.95 → 5.85	C	WR187	RG-49/U (Brass) RG-95/U (Aluminum)	UG-149A/U			Cover	2	20-11-5035-1239	[G]-(026)
				UG-407/U						
				UG-1728/U	CPR-187F		Flat Contact	1	20-01-5135-1239**	[G]-(027)
				UG-1729/U						
						CMR-187	Flat Contact	1	20-01-5235-1239**	[G]-(028)
UG-148C/U			Choke	4	20-02-6555-1212	[K]-(029)				
UG-406B/U										
UG-1352/U	CPR-187G		Contact	3	20-03-6655-1212	[K]-(030)				
UG-1353/U										
	CPR-187G/F		Choke/Flat	6 ^{†††}	20-03-3561-1212	—				
3.30 → 4.90		WR229		UG-1726/U	CPR-229F		Flat Contact	1	20-01-5140-1239**	[G]-(031)
				UG-1727/U						
						CMR-229	Flat Contact	1	20-01-5240-1239**	[G]-(032)
	CPR-229G	Choke	3	20-03-L768-1212						
2.6 → 3.95	S	WR284	RG-48/U (Brass) RG-75/U (Aluminum)	UG-53/U			Cover	2	20-01-5045-1239**	[G]-(033)
				UG-584/U						
				UG-1724/U	CPR-284F		Flat Contact	1	20-01-5145-1239**	[G]-(034)
				UG-1725/U						
						CMR-284	Flat Contact	1	20-01-5245-1239**	[G]-(035)
UG-54B/U			Choke	5	20-02-6565-1212	[K]-(036)				
UG-585A/U										
UG-1348/U	CPR-284G		Contact	3	20-03-6665-1212	[K]-(037)				
UG-1349/U										
2.2 → 3.3		WR340	RG-112/U (Brass) RG-112/U (Aluminum)	UG-533/U			Flat Contact	1	20-01-5050-1239**	[G]-(038)
				UG-554/U						
		CPR-340F		Flat Contact	1	20-01-5150-1239**	[G]-(039)			
1.7 → 2.6	W	WR430	RG-104/U (Brass) RG-105/U (Aluminum)	UG-435A/U			Flat Contact	1	20-01-5055-1239**	[G]-(040)
				UG-437A/U						
					CPR-430F		Flat Contact	1	20-01-5155-1239**	[G]-(041)
	CPR-430G		Choke	3 ^{††}	20-03-1560-1212	—				
							CPR-430G/F	Choke/Flat	6 ^{†††}	20-03-6685-1212
1.12 → 1.7	L	WR650	RG-69/U (Brass) RG-103/U (Aluminum)	UG-417A/U			Flat Contact	1	20-01-5060-1239**	[G]-(042)

* Number corresponds to configuration type, Tables 7-9 to 7-14

** This gasket will seal a maximum pressure of 20 psi. For systems pressurized above this limit, a high-pressure (raised-lip) version is available. To specify, change 3rd digit in Part Number from 0 to 1.

[†] Letter in bracket is MIL-DTL-83528 material type (G or K). Number in parentheses is MIL-DTL-83528 dash number. Insert them (without brackets or parentheses) to complete MIL P/N.

^{††} Modified "O" cross section

^{†††} Modified "D" cross section

Waveguide Gasket - Product Information

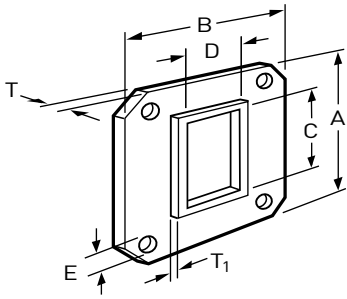

Note: Raised portion will have a nominal width of 0.187 in. [4.75 mm]. Thickness [T₁] is 0.004 in. [0.10 mm] ±0.002 in. [0.05 mm]. This raised area applies only to part number with a third digit of "1"

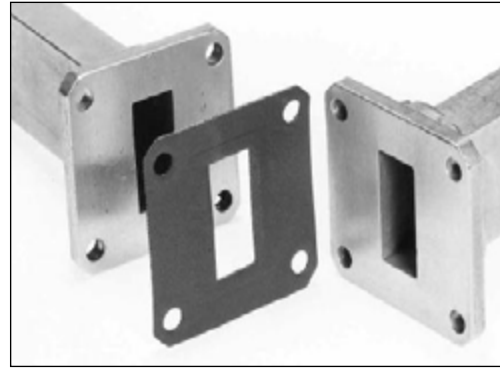

Table 7-9

CONFIGURATION 1 - DIE-CUT RECTANGULAR							
Dimensions inches (mm)						MIL P/N: ¹ M83528/ 013G-()	Chomerics P/N**
A	B	C	D	E*	T		
±0.015 (0.38)	±0.015 (0.38)	±0.015 (0.38) - 0.000		±0.010 (0.25)	±0.003 (0.08)		
1.496 (38.00)	1.496 (38.00)	0.760 (19.30)	0.385 (9.78)	0.155 (3.94)	0.027 (0.69)	007	20-11-1683-1239
0.750 (19.05)	0.750 (19.05)	0.145 (3.68)	0.285 (7.24)	0.116 (2.95)	0.027 (0.69)	001	20-01-5000-1239
0.875 (22.23)	0.875 (22.23)	0.175 (4.45)	0.425 (10.80)	0.116 (2.95)	0.027 (0.69)	003	20-01-5005-1239
1.313 (33.35)	1.313 (33.35)	0.630 (16.00)	0.320 (8.13)	0.140 (3.56)	0.027 (0.69)	005	20-01-5010-1239
1.625 (41.28)	1.625 (41.28)	0.905 (22.99)	0.405 (10.29)	0.169 (4.29)	0.027 (0.69)	009	20-01-5015-1239
1.875 (47.63)	1.875 (47.63)	1.130 (28.70)	0.505 (12.83)	0.180 (4.57)	0.027 (0.69)	015	20-11-5020-1239
3.750 (92.25)	5.440 (138.18)	1.710 (43.43)	3.410 (86.61)	0.264 (6.71) 0.250 (6.35)	0.027 (0.69)	038	20-01-5050-1239
4.188 (106.38)	6.344 (161.14)	2.160 (54.86)	4.310 (109.47)	0.266 (6.76) 0.281 (7.14)	0.027 (0.69)	040	20-01-5055-1239
5.438 (138.13)	8.688 (220.68)	3.260 (82.80)	6.510 (165.35)	0.250 (6.35) 0.328 (8.33)	0.027 (0.69)	042	20-01-5060-1239
1.594 (40.49)	2.094 (53.19)	0.405 (10.29)	0.905 (22.99)	0.169 (4.29)	0.027 (0.69)	010	20-01-5115-1239
1.750 (44.45)	2.500 (63.50)	0.505 (12.83)	1.130 (28.70)	0.171 (4.34)	0.027 (0.69)	016	20-01-5120-1239
1.937 (49.20)	2.687 (68.25)	0.633 (16.08)	1.380 (35.05)	0.206 (5.23)	0.027 (0.69)	020	20-01-5125-1239
2.438 (61.93)	3.188 (80.98)	0.805 (20.45)	1.600 (40.64)	0.257 (6.53)	0.027 (0.69)	024	20-01-5130-1239
3.500 (88.90)	2.500 (63.50)	1.880 (47.75)	0.880 (22.35)	0.266 (6.76)	0.027 (0.69)	027	20-01-5135-1239
2.750 (69.85)	3.875 (98.43)	1.155 (29.34)	2.300 (58.42)	0.270 (6.86)	0.027 (0.69)	031	20-01-5140-1239
4.50 (114.30)	3.000 (76.20)	2.850 (72.39)	1.350 (34.29)	0.266 (6.76)	0.027 (0.69)	034	20-01-5145-1239
3.750 (95.25)	5.438 (138.13)	1.710 (43.43)	3.410 (86.61)	0.266 (6.76)	0.027 (0.69)	039	20-01-5150-1239
6.344 (161.14)	4.188 (106.38)	4.310 (109.47)	2.160 (54.86)	0.266 (6.76)	0.027 (0.69)	041	20-01-5155-1239
1.531 (38.89)	2.281 (57.94)	0.632 (16.05)	1.382 (35.10)	0.150 (3.81)	0.027 (0.69)	021	20-01-5225-1239
1.750 (44.45)	2.500 (63.50)	0.800 (20.32)	1.600 (40.64)	0.160 (4.06) 0.150 (3.81)	0.027 (0.69)	025	20-01-5230-1239
1.784 (45.31)	2.781 (70.64)	0.882 (22.40)	1.882 (47.80)	0.156 (3.96) 0.141 (3.58)	0.027 (0.69)	028	20-01-5235-1239
2.000 (50.80)	3.156 (80.16)	1.155 (29.34)	2.300 (58.42)	0.150 (3.81)	0.027 (0.69)	032	20-01-5240-1239
3.844 (97.64)	2.344 (59.54)	2.850 (72.39)	1.350 (34.29)	0.172 (4.37) 0.188 (4.78)	0.027 (0.69)	028	20-01-5245-1239

* Hole locations conform to holes in standard waveguide flanges identified in Table 2. Where two hole diameters are given, flange has hole of two different diameters.

¹ Number in parentheses is MIL-DTL-83528 dash number, which should be inserted (without parentheses) at end of MIL P/N.

MOLDED

Waveguide Gasket - Product Information

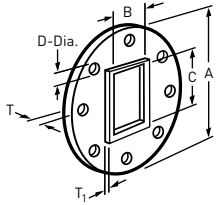

Note: Raised portion will have a nominal width of 0.187 in. (4.75 mm). Thickness (T₁) is 0.004 in. (0.10 mm) ±0.002 in. (0.05 mm). This raised area applies only to part number with a third digit of "1".

Table 7-10

CONFIGURATION 2 - DIE-CUT CIRCULAR					MIL P/N: M83528/ 013G () ¹	Chomerics P/N
Dimensions inches (mm)						
A	B	C	D*	T		
±0.015 (0.38)	±0.015 (0.38) - 0.000		±0.010 (0.38)	±0.003 (0.08)		
3.125 (79.38)	0.632 (16.05)	1.382 (35.10)	0.234 (5.94)	0.027 (0.69)	019	20-11-5025-1239
3.625 (92.08)	0.882 (22.40)	1.882 (47.80)	0.234 (5.94)	0.027 (0.69)	026	20-11-5035-1239
5.312 (134.93)	1.350 (34.29)	2.850 (72.39)	0.290 (7.37)	0.027 (0.69)	033	20-01-5045-1239

* Hole locations conform to holes in standard waveguide flanges identified in Table 2.

¹ Number in parentheses is MIL-DTL-83528 dash number, which should be inserted (without parentheses) at end of MIL P/N.

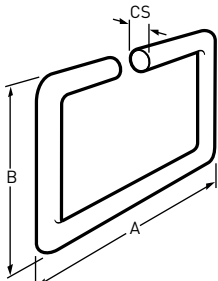

Table 7-11

CONFIGURATION 3 - MOLDED RECTANGULAR WITH "O" CROSS SECTION				MIL P/N: M83528/ 013K-() ¹	Chomerics P/N
Dimensions inches (mm)					
A	B	CS	H		
1.368 (34.75)	0.868 (22.05)	0.103 (2.62)	—	013	20-03-6630-1212
1.616 (41.05)	0.991 (25.17)	0.103 (2.62)	—	018	20-03-6635-1212
1.866 (47.40)	1.116 (28.35)	0.103 (2.62)	—	023	20-03-6645-1212
2.449 (62.20)	1.449 (36.80)	0.139 (3.53)	—	030	20-03-6655-1212
3.451 (87.66)	1.951 (49.56)	0.139 (3.53)	—	037	20-03-6665-1212
2.167 (55.04)	1.372 (34.85)	0.139 (3.53)	—	NA	20-03-L767-1212
2.867 (72.82)	1.722 (43.74)	0.139 (3.53)	—	NA	20-03-L768-1212
5.160 (131.06)	3.010 (76.45)	0.250 (6.35)	0.144 (36.58)	NA	20-03-1560-1212*

¹ Number in parentheses is MIL-DTL-83528 dash number, which should be inserted (with out parentheses) at end of MIL P/N.

*Modified "O" Cross Section.

Table 7-12

CONFIGURATION 4 - MOLDED CIRCULAR WITH "O" CROSS SECTION			
Dimensions inches (mm)		MIL P/N: M83528/ 013K-() ¹	Chomerics P/N
ID	CS		
2.011 (51.08)	0.139 (3.53)	022	20-02-6545-1212
2.683 (68.15)	0.115 (2.92)	029	20-02-6555-1212
1.110 (28.19)	0.062 (1.57)	—	19-00-12349-1212

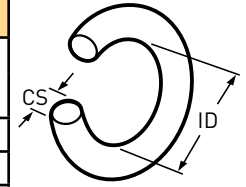

¹ Number in parentheses is MIL-DTL-83528 dash number, which should be inserted (with out parentheses) at end of MIL P/N.

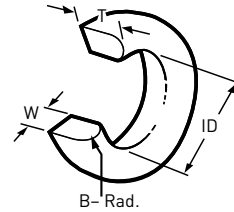

Table 7-13

CONFIGURATION 5 - MOLDED CIRCULAR WITH "D" CROSS SECTION					MIL P/N: M83528/ 013K-() ¹	Chomerics P/N
Dimensions inches (mm)						
T	B	ID	W			
0.056 (1.42)	0.041 (1.04)	0.410 (10.41)	0.082 (2.08)	002	20-02-6510-1212	
0.048 (1.22)	Full Rad. —	0.587 (14.91)	0.078 (1.98)	004	20-02-6515-1212	
0.125 (3.18)	Full Rad. —	0.885 (22.48)	0.155 (3.94)	006	20-02-6520-1212	
0.065 (1.65)	0.49 (1.25)	1.122 (28.50)	0.099 (2.51)	008	20-02-6525-1212	
0.077 (1.96)	Full Rad. —	1.310 (33.27)	0.115 (2.92)	012	20-02-6530-1212	
0.088 (2.24)	Full Rad. —	1.340 (34.04)	0.095 (2.41)	011	20-02-6531-1212	
0.085 (2.16)	Full Rad. —	1.392 (35.36)	0.095 (2.41)	014	20-02-6535-1212*	
0.078 (1.78)	Full Rad. —	1.550 (39.37)	0.105 (2.68)	017	20-02-6540-1212	
0.188 (4.76)	Full Rad. —	3.910 (99.31)	0.240 (6.10)	036	20-02-6565-1212	

¹ Number in parentheses is MIL-DTL-83528 dash number, which should be inserted (with out parentheses) at end of MIL P/N.

* Contact Parker Chomerics Application Engineering for groove analysis

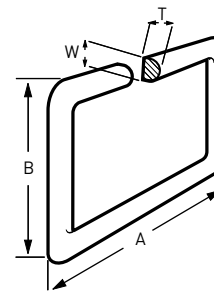

Table 7-14

CONFIGURATION 6 - MOLDED RECTANGULAR WITH "D" CROSS SECTION				Chomerics P/N
Dimensions inches (mm)				
A	B	W	T	
1.616 (41.05)	0.991 (25.17)	0.103 (2.62)	0.053 (1.35)	20-03-3686-1212
1.866 (47.40)	1.116 (28.35)	0.103 (2.62)	0.053 (1.35)	20-03-3731-1212
2.167 (55.04)	1.372 (34.85)	0.120 (3.05)	0.060 (1.52)	20-03-3980-1212
2.449 (62.20)	1.449 (36.80)	0.139 (3.53)	0.070 (1.78)	20-03-3561-1212
5.160 (131.06)	3.010 (76.45)	0.250 (6.35)	0.074 (1.88)	20-03-6685-1212*

*Modified "D" Cross Section.

Conductive Elastomer Flat Washers

FLAT WASHER GASKETS

CHO-SEAL flat washers are available in hundreds of different sizes. ID's and OD's are available in increments of .016 in. (0.41 mm). Some of the more common sizes are listed in Table 7-15. For more information, contact Parker Chomerics Applications Engineering.

Note: The $(OD - ID)/2$ of a flat washer cannot be less than the thickness of the material. Standard minimum wall thickness is 0.080".



ORDERING PROCEDURE

Select the part number from Table 7-15. The last four digits designate the material. Consult Parker Chomerics on other available sizes.

Flat Washer Gasket - Product Information

For applications requiring a custom part, submit a drawing similar to the figure shown, indicating dimensions ID, OD and T. Part number for custom parts will be assigned by Parker Chomerics.

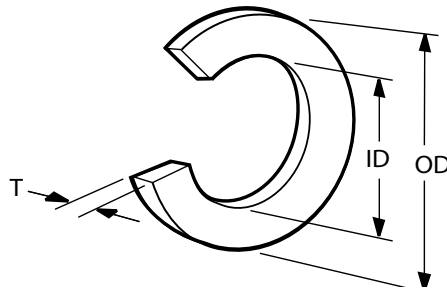

Table 7-15

FLAT WASHERS				
Nominal Diameters inches (mm)		Thickness T inches (mm)	Chomerics P/N*	MIL P/N: M83528/ 012X [†] -()
ID ±0.015 (0.38)	OD ±0.015 (0.38)			
0.250 (6.35)	0.625 (15.86)	0.032 (0.81) 0.062 (1.57)	10-02-1859-XXXXX 10-03-1859-XXXXX	001 002
0.375 (9.53)	0.750 (19.05)	0.032 (0.81) 0.062 (1.57)	10-02-1492-XXXXX 10-03-1492-XXXXX	003 004
0.500 (12.70)	0.656 (16.66)	0.032 (0.81) 0.062 (1.57)	10-02-1388-XXXXX 10-03-1388-XXXXX	005 006
0.500 (12.70)	0.875 (22.23)	0.032 (0.81) 0.062 (1.57)	10-02-1494-XXXXX 10-03-1494-XXXXX	007 008
0.750 (19.05)	1.000 (25.40)	0.032 (0.81) 0.062 (1.57)	10-02-2736-XXXXX 10-03-2736-XXXXX	009 010
1.000 (25.40)	1.438 (36.53)	0.032 (0.81) 0.062 (1.57)	10-02-1493-XXXXX 10-03-1493-XXXXX	011 012

[†] "X" should be replaced by applicable MIL-DTL-83528 material type (e.g., A, B, C, etc.). Number in parentheses is MIL-DTL-83528 dash number. Insert it (without parentheses) to complete MIL P/N.

* -XXXXX designates material (1215, 1285, etc.). Refer to Chomerics Conductive Elastomer EMI Gaskets Molded and Extruded Materials Selector Guide for details.

Conductive Elastomer Molded Gaskets



STANDARD PARTS

Parker Chomerics produces molded conductive elastomer EMI gaskets in hundreds of standard sizes in the following forms:

- O- and D-rings, flat washers
- Connector Gaskets - Interfacial Mil Spec (MS) connector seals; D-subminiature rectangular; Jam-nut seals
- Waveguide Gaskets - Molded circular and rectangular (O or D cross section)

CUSTOM MOLDED ELASTOMERIC SHAPES

Parker Chomerics can mold conductive elastomer EMI gaskets to fit practically any application. With our range of high quality materials and efficient manufacturing systems we can provide attractive choices in price and performance.

Parker Chomerics engineers can rapidly optimize gasket designs (at little or no cost), using tools such as finite element analysis (see next page). Prototype development, tooling and part delivery are performed to meet our customers' requirements, with adherence to the industry's highest quality standards.

Custom elastomer gaskets can include tight corners, retention bumps, ribs and other special geometries. Many other features can be added, such as fabric or mesh reinforcement, pressure-sensitive adhesive, and compression stops. Non-conductive environmental seals can be bonded to or co-molded with conductive EMI shielding elastomers. Contact Parker Chomerics Applications Engineering Department to discuss how custom conductive elastomer shapes can be designed to meet your application requirements. Table 7-16 provides general tolerances for molded conductive elastomer gaskets.

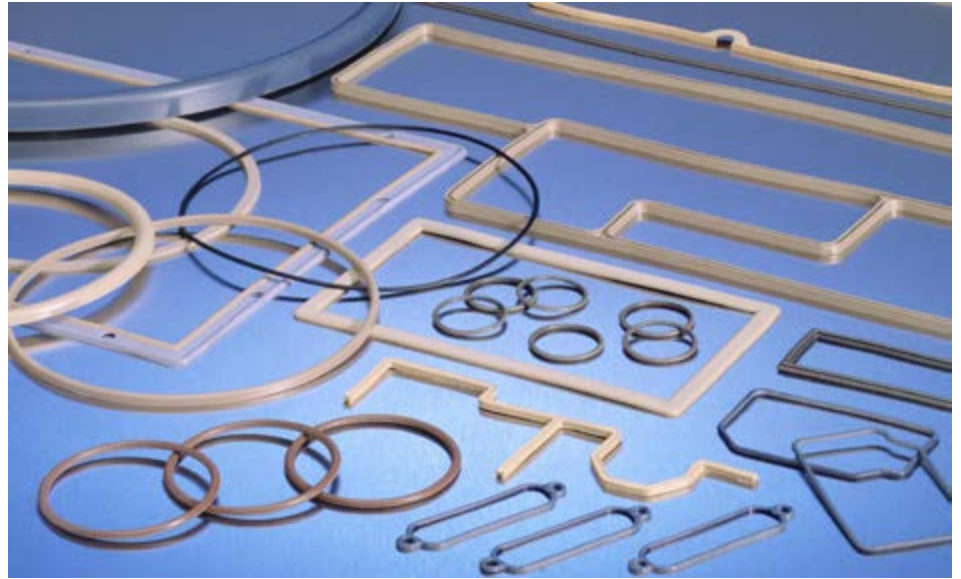

FINITE ELEMENT ANALYSIS

Parker Chomerics specializes in elastomer finite element analysis (FEA), using the MARC K6 Series software as a foundation of FEA capability.

Benefits of FEA include:

- Optimizing elastomer gasket designs
- Allowing accurate predictions of alternate design concepts
- Eliminating part and tooling charges as well as extensive trial and error prototype evaluation

This advanced computer simulation technology enables compression/deflection characteristics and other parameters to be evaluated and optimized during the design phase, without the delays of trial-and-error prototyping. FEA is routinely employed in the development of

Molded-In-Place Cover Seals.

For additional information contact our Applications Engineering Department. Table 7-16 provides general tolerances for molded conductive elastomer gaskets.

Molded Gaskets - Product Information

SIZE LIMITATIONS

Parker Chomerics can produce Molded-In-Place gasket/panel assemblies in any overall dimension larger than $\frac{3}{4}$ x $\frac{3}{4}$ in. (19 x 19 mm). Minimum recommended gasket profile cross section is 0.062 in. (1.6 mm), with a minimum thickness of 0.020 in. (0.5 mm) for flat gaskets. Smaller cross sections and thicknesses, although not recommended, can be accommodated.

Table 7-16

Molded Gaskets inches (mm)	Tolerances inches (mm)
Overall Dimensions	
0.100 to 1.500 (2.54 to 38.10)	±0.010 (0.25)
1.501 to 2.500 (38.13 to 63.50)	±0.015 (0.38)
2.501 to 4.500 (63.53 to 114.30)	±0.020 (0.51)
4.501 to 7.000 (114.33 to 177.80)	±0.025 (0.64)
>7.000 (>177.80)	0.35% nom. dim.
Cross Section	
0.040 to 0.069 (1.02 to 1.75)	±0.003 (0.08)
0.070 to 0.100 (1.78 to 2.54)	±0.004 (0.11)
0.101 to 0.200 (2.57 to 5.08)	±0.005 (0.13)
0.201 to 0.350 (5.11 to 8.89)	±0.008 (0.20)

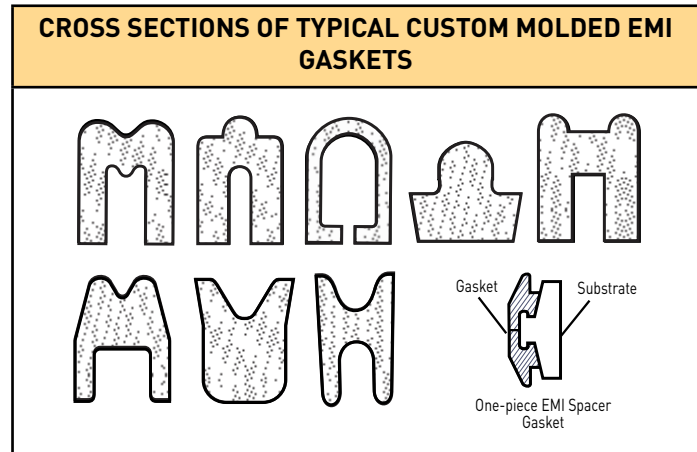

Refer to Parker Chomerics Conductive Elastomer EMI Gaskets Molded and Extruded Materials Selector Guide for details. Note that these parts are available only in Cho-Seal materials with the "M" (Molded) format.

Figures 7-1, 7-2 and Graph 7-1

A typical use of FEA in designing molded gaskets is the evaluation of force and deflection needed for proposed designs. The FEA shown in Figure 7-1, performed on the cross section in Figure 7-2 predicts the gasket's deflection characteristics and compression requirements reported in Graph 7-1.

Figure 7-1

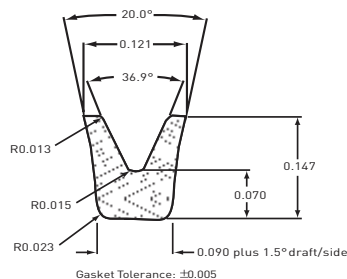
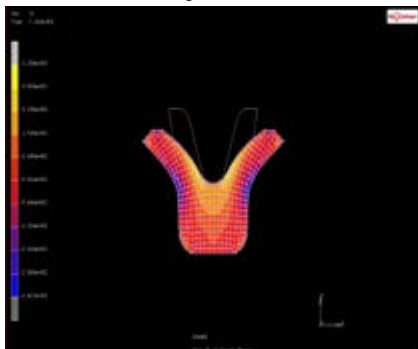
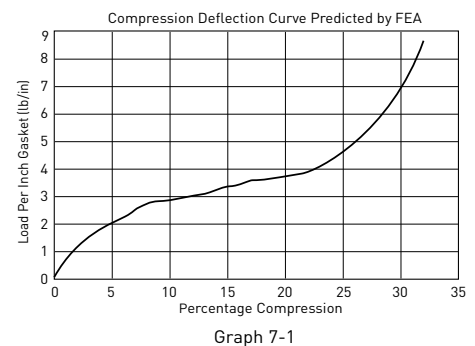
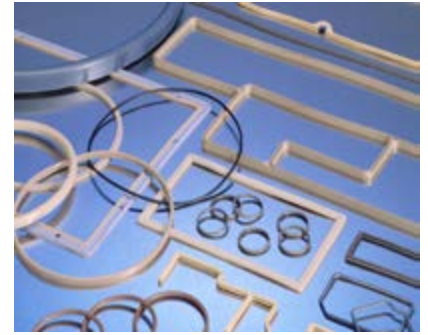

Figure 7-2



Graph 7-1

Conductive Elastomer Molded D- and O-Rings



MOLDED D- AND O-RINGS

Parker Chomerics D-Ring and O-Ring gaskets provide moisture/pressure sealing and EMI/EMP shielding when compressed in a properly designed groove. They are interchangeable with standard non-conductive seals of the same dimensions. Rings with ID's greater than 2 in. (51 mm) can be made by splicing extruded materials rather than by molding if groove corner radii are generous. Consult Parker Chomerics before ordering.

Note: Grooves for solid D-Rings should be designed to assure 8 to 20% deflection of the gasket height, and 97% maximum groove fill when groove dimensions are on the low side and gasket dimensions are on the high side of the allowable tolerance. For O-Ring grooves, use 10 to 25% deflection of the gasket, and 97% maximum groove fill. Table 7-17 provides general tolerances for Molded D-Ring and Table 7-19 provides general tolerances for Molded O-Ring conductive elastomer gaskets.



ORDERING PROCEDURE

Select the part number from Table 7-18 (D-Rings) and Table 7-20 (O-Rings). Additional sizes are available.

For custom sizes, drawings must be provided. Part number will be assigned by Chomerics.

Molded D- and O-Ring Gasket - Product Information

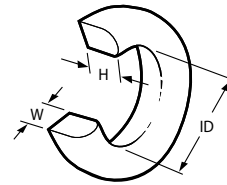

Table 7-17

Molded D-Ring Gaskets inches (mm)	TOLERANCE inches (mm)
Cross Section	
0.040 to 0.069 (1.02-1.75)	±0.003 (±0.08)
0.070 to 0.100 (1.78-2.54)	±0.004 (±0.10)
0.101 to 0.200 (2.57-5.08)	±0.005 (±0.13)
0.201 to 0.350 (5.11-8.89)	±0.008 (±0.20)
Inside Diameters	
0.100 to 1.500 (2.54 to 38.10)	±0.010 (±0.25)
1.501 to 2.500 (38.13 to 63.50)	±0.015 (±0.38)
2.501 to 4.500 (63.53 to 114.30)	±0.020 (±0.51)
4.501 to 7.000 (114.33 to 177.80)	±0.025 (±0.64)
>7.00 (>177.80)	±0.35% of nom. dim.

ORDERING PROCEDURE

Select the part number from Table 7-18 (D-Rings) and Table 7-20 (O-Rings). Additional sizes are available. For custom sizes, drawings must be provided. Part number will be assigned by Chomerics.

Table 7-18

D-RINGS			
Chomerics P/N	Nominal Dimensions inches (mm)		
	H	W	ID
10-01-6515-XXXXX	0.048 (1.22)	0.078 (1.98)	0.587 (14.91)
10-01-1238-XXXXX	0.059 (1.50)	0.093 (2.36)	2.705 (68.71)
10-01-1239-XXXXX	0.059 (1.50)	0.095 (2.41)	3.193 (81.10)
10-01-1240-XXXXX	0.061 (1.55)	0.025 (0.66)	0.180 (4.57)
10-01-1241-XXXXX	0.061 (1.55)	0.039 (0.99)	0.151 (3.84)
10-01-1628-XXXXX	0.062 (1.57)	0.096 (2.44)	1.562 (39.67)
10-01-1154-XXXXX	0.062 (1.57)	0.069 (1.75)	0.893 (22.68)
10-01-1375-XXXXX	0.066 (1.68)	0.059 (1.50)	0.565 (14.35)
10-01-6525-XXXXX	0.067 (1.70)	0.097 (2.46)	1.094 (27.79)
10-01-1142-XXXXX	0.069 (1.75)	0.094 (2.39)	1.072 (27.23)
10-01-1188-XXXXX	0.070 (1.78)	0.065 (1.65)	0.809 (20.55)
10-01-1623-XXXXX	0.073 (1.85)	0.034 (0.86)	0.230 (5.84)
10-01-1143-XXXXX	0.076 (1.93)	0.097 (2.46)	1.460 (37.08)
10-01-1601-XXXXX	0.076 (1.93)	0.095 (2.41)	1.397 (35.48)
10-01-1144-XXXXX	0.076 (1.93)	0.097 (2.46)	1.581 (40.16)
10-01-2238-XXXXX	0.076 (1.93)	0.113 (2.87)	1.262 (32.05)
10-01-6540-XXXXX	0.077 (1.96)	0.103 (2.62)	1.511 (38.37)
10-01-6535-XXXXX	0.083 (2.11)	0.093 (2.36)	1.357 (34.48)
10-01-1187-XXXXX	0.101 (2.57)	0.130 (3.30)	0.592 (15.04)
10-01-1131-XXXXX	0.118 (2.98)	0.174 (4.42)	1.385 (35.18)
10-01-6520-XXXXX	0.125 (3.18)	0.155 (3.94)	0.885 (22.48)
10-01-1264-XXXXX	0.123 (3.12)	0.123 (3.12)	0.853 (21.67)
10-01-1766-XXXXX	0.125 (3.18)	0.138 (3.51)	2.859 (72.62)
10-01-1120-XXXXX	0.130 (7.69)	0.180 (4.57)	3.412 (86.66)
10-01-6565-XXXXX	0.188 (4.78)	0.234 (5.94)	3.837 (37.46)

-XXXXX designates material (1215, 1285, etc). Refer to Parker Chomerics Conductive Elastomer EMI Gaskets Molded and Extruded Materials Selector Guide for details. Note that these parts are available only in CHO-SEAL materials with the "M" (Molded) format.

Molded D- and O-Ring Gasket - Product Information

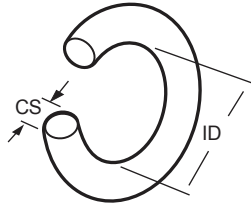

Table 7-19

Molded O-Ring Gaskets inches (mm)	TOLERANCE inches (mm)
Cross Section	
0.040 to 0.069 (1.02-1.75)	±0.003 (±0.08)
0.070 to 0.100 (1.78-2.54)	±0.004 (±0.10)
0.101 to 0.200 (2.57-5.08)	±0.005 (±0.13)
0.201 to 0.350 (5.11-8.89)	±0.008 (±0.20)
Inside Diameter	
0.100 to 1.500 (2.54 to 38.10)	±0.010 (±0.25)
1.501 to 2.500 (38.13 to 63.50)	±0.015 (±0.38)
2.501 to 4.500 (63.53 to 114.30)	±0.020 (±0.51)
4.501 to 7.000 (114.33 to 177.80)	±0.025 (±0.64)
>7.00 (>177.80)	±0.35% of nom. dim.

Table 7-20

O-RINGS				
Chomerics P/N*	MIL P/N: M83528/00 []X'-()	MS 29513 MS 9021 Dash No.	Dimensions inches (mm)	
			CS	ID
10-00-2231-XXXX	[5] (001)	—	0.030 (0.76)	0.442 (11.23)
10-00-2232-XXXX	[5] (002)	—	0.030 (0.76)	0.577 (14.66)
10-00-2259-XXXX	[5] (003)	—	0.030 (0.76)	0.692 (17.58)
10-00-2233-XXXX	[5] (004)	—	0.030 (0.76)	0.817 (20.75)
10-00-1413-XXXX	[5] (005)	—	0.039 (0.99)	0.425 (10.80)
10-00-2777-XXXX	[5] (006)	—	0.048 (1.22)	0.295 (7.49)
10-00-1406-XXXX	[5] (007)	—	0.050 (1.27)	0.533 (13.54)
10-00-1405-XXXX	[5] (008)	—	0.051 (1.30)	0.446 (11.33)
10-00-1407-XXXX	[5] (009)	—	0.057 (1.45)	0.415 (10.54)
10-00-1376-XXXX	[5] (010)	—	0.063 (1.60)	0.541 (13.74)
10-00-1342-XXXX	[5] (011)	—	0.063 (1.60)	0.648 (16.46)
10-00-1631-XXXX	[5] (012)	—	0.068 (1.73)	0.847 (21.51)
10-00-1770-XXXX	[5] (013)	—	0.068 (1.73)	1.182 (30.02)
10-00-1478-XXXX	[5] (014)	—	0.068 (1.73)	3.165 (80.39)
10-00-3811-XXXX	[2] (007)	007	0.070 (1.78)	0.145 (3.68)
10-00-2226-XXXX	[2] (011)	011	0.070 (1.78)	0.301 (7.65)
10-00-5983-XXXX	[2] (012)	012	0.070 (1.78)	0.364 (9.25)
10-00-2227-XXXX	[2] (013)	013	0.070 (1.78)	0.426 (10.82)
10-00-1980-XXXX	[2] (014)	014	0.070 (1.78)	0.489 (12.42)
10-00-0008-XXXX	[5] (015)	—	0.070 (1.78)	0.495 (15.57)

Table 7-20

O-RINGS				
Chomerics P/N*	MIL P/N: M83528/00 []X'-()	MS 29513 MS 9021 Dash No.	Dimensions inches (mm)	
			CS	ID
10-00-2065-XXXX	[2] (015)	015	0.070 (1.78)	0.551 (14.00)
10-00-0010-XXXX	[5] (016)	—	0.070 (1.78)	0.610 (15.49)
10-00-2085-XXXX	[5] (017)	—	0.070 (1.78)	0.635 (16.13)
10-00-1689-XXXX	[5] (018)	—	0.070 (1.78)	0.667 (16.94)
10-00-2066-XXXX	[2] (017)	017	0.070 (1.78)	0.676 (17.17)
10-00-1690-XXXX	(NA)	—	0.070 (1.78)	0.738 (18.75)
10-00-0012-XXXX	(NA)	—	0.070 (1.78)	0.735 (18.67)
10-00-2075-XXXX	[2] (018)	108	0.070 (1.78)	0.739 (18.77)
10-00-1981-XXXX	[2] (019)	019	0.070 (1.78)	0.801 (20.35)
10-00-0014-XXXX	[5] (019)	—	0.070 (1.78)	0.860 (21.85)
10-00-2076-XXXX	[2] (020)	020	0.070 (1.78)	0.864 (21.95)
10-00-1843-XXXX	[2] (021)	021	0.070 (1.78)	0.926 (23.52)
10-00-2068-XXXX	[2] (022)	022	0.070 (1.78)	0.989 (25.12)
10-00-2536-XXXX	(NA)	—	0.070 (1.78)	1.046 (26.57)
10-00-2029-XXXX	(NA)	—	0.070 (1.78)	1.110 (28.19)
10-00-2069-XXXX	[2] (024)	024	0.070 (1.78)	1.114 (28.30)
10-00-1844-XXXX	(NA)	—	0.070 (1.78)	1.176 (29.87)
10-00-2084-XXXX	[5] (020)	—	0.070 (1.78)	1.230 (31.24)
10-00-2070-XXXX	[2] (026)	026	0.070 (1.78)	1.239 (31.47)
10-00-2535-XXXX	(NA)	—	0.070 (1.78)	1.296 (32.92)
19-00-M314-XXXX	(NA)	027	0.070 (1.78)	1.301 (33.05)

* For certain materials and configurations, a minimum order requirement may apply. -XXXXX designates material (1215, 1285, etc). Refer to Chomerics Conductive Elastomer EMI Gaskets Molded and Extruded Materials Selector Guide for details. Note that these parts are available only in Cho-Seal materials with the "M" (Molded) format.

† "X" should be replaced by applicable MIL-DTL-83528 material type (e.g., A, B, C, etc.). Number in bracket is MIL-DTL-83528 slash sheet. Number in parentheses is MIL-DTL-83528 dash number. Insert them (without brackets or parentheses) to complete MIL P/N.

MOLDED

Molded D- and O-Ring Gasket - Product Information

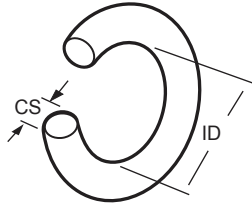

Table 7-19

Molded O-Ring Gaskets inches (mm)	TOLERANCE inches (mm)
Cross Section	
0.040 to 0.069 (1.02-1.75)	±0.003 (±0.08)
0.070 to 0.100 (1.78-2.54)	±0.004 (±0.10)
0.101 to 0.200 (2.57-5.08)	±0.005 (±0.13)
0.201 to 0.350 (5.11-8.89)	±0.008 (±0.20)
Inside Diameter	
0.100 to 1.500 (2.54 to 38.10)	±0.010 (±0.25)
1.501 to 2.500 (38.13 to 63.50)	±0.015 (±0.38)
2.501 to 4.500 (63.53 to 114.30)	±0.020 (±0.51)
4.501 to 7.000 (114.33 to 177.80)	±0.025 (±0.64)
>7.00 (>177.80)	±0.35% of nom. dim.

Table 7-20 continued

O-RINGS				
Chomerics P/N*	MIL P/N: M83528/00 []X'-()	MS 29513 MS 9021 Dash No.	Dimensions inches (mm)	
			CS	ID
10-00-2228-XXXXX	(NA)	—	0.070 (1.78)	1.362 (34.59)
10-00-2071-XXXXX	[2] (028)	028	0.070 (1.78)	1.364 (34.65)
10-00-0024-XXXXX	(NA)	—	0.070 (1.78)	1.485 (37.72)
10-00-2677-XXXXX	(NA)	—	0.070 (1.78)	1.609 (40.87)
10-00-4123-XXXXX	(NA)	030	0.070 (1.78)	1.614 (41.00)
10-00-2229-XXXXX	(NA)	—	0.070 (1.78)	1.674 (42.52)
10-00-0028-XXXXX	(NA)	—	0.070 (1.78)	1.735 (44.07)
10-00-4124-XXXXX	(NA)	032	0.070 (1.78)	1.864 (47.35)
10-00-0032-XXXXX	(NA)	—	0.070 (1.78)	1.980 (50.29)
10-00-2230-XXXXX	(NA)	—	0.070 (1.78)	3.009 (76.43)
10-00-0052-XXXXX	(NA)	—	0.070 (1.78)	3.170 (80.52)
10-00-2040-XXXXX	(NA)	043	0.070 (1.78)	3.486 (88.62)
10-00-2320-XXXXX	(NA)	—	0.076 (1.93)	0.656 (16.66)
10-00-2321-XXXXX	(NA)	—	0.076 (1.93)	0.779 (19.79)
10-00-1827-XXXXX	(NA)	—	0.084 (2.13)	0.852 (21.64)
10-00-0044-XXXXX	(NA)	—	0.084 (2.13)	2.678 (68.02)
10-00-0020-XXXXX	(NA)	—	0.087 (2.21)	1.250 (31.75)
10-00-0038-XXXXX	(NA)	—	0.087 (2.21)	2.360 (59.94)
10-00-3550-XXXXX	(NA)	—	0.094 (2.39)	0.750 (19.05)
10-00-1459-XXXXX	(NA)	—	0.095 (2.41)	0.897 (22.78)
10-00-1378-XXXXX	(NA)	—	0.095 (2.41)	1.074 (27.28)

Table 7-20 continued

O-RINGS				
Chomerics P/N*	MIL P/N: M83528/00 []X'-()	MS 29513 MS 9021 Dash No.	Dimensions inches (mm)	
			CS	ID
10-00-4452-XXXXX	(NA)	—	0.100 (2.54)	1.005 (25.53)
10-00-1754-XXXXX	(NA)	—	0.101 (2.57)	2.805 (71.25)
10-00-1359-XXXXX	(NA)	—	0.101 (2.57)	3.153 (80.87)
10-00-1360-XXXXX	(NA)	—	0.101 (2.57)	3.613 (80.87)
10-00-1921-XXXXX	[2] (114)	—	0.103 (2.62)	0.799 (20.29)
10-00-4685-XXXXX	[5] (021)	—	0.103 (2.62)	1.040 (26.42)
10-00-2086-XXXXX	(NA)	—	0.103 (2.62)	1.240 (31.50)
10-00-1845-XXXXX	[2] (126)	—	0.103 (2.62)	1.362 (34.59)
10-00-2072-XXXXX	[2] (128)	128	0.103 (2.62)	1.487 (37.77)
10-00-1846-XXXXX	[5] (022)	130	0.103 (2.62)	1.612 (40.94)
10-00-2031-XXXXX	[2] (132)	132	0.103 (2.62)	1.737 (44.12)
10-00-2087-XXXXX	[5] (023)	—	0.103 (2.62)	1.790 (45.47)
10-00-2030-XXXXX	[2] (142)	142	0.103 (2.62)	2.362 (59.99)
10-00-1691-XXXXX	[2] (155)	—	0.103 (2.62)	3.987 (101.27)
10-00-1573-XXXXX	(NA)	—	0.115 (2.92)	2.876 (73.05)
10-00-1607-XXXXX	(NA)	—	0.147 (3.73)	2.265 (57.53)
10-00-1608-XXXXX	(NA)	—	0.147 (3.73)	3.690 (93.73)
10-00-1782-XXXXX	(NA)	—	0.188 (4.78)	0.673 (17.09)
10-00-1746-XXXXX	(NA)	—	0.210 (5.33)	3.475 (12.07)
10-00-1354-XXXXX	(NA)	—	0.243 (6.17)	3.409 (86.59)
10-00-1747-XXXXX	(NA)	—	0.394 (10.01)	3.464 (87.99)

* For certain materials and configurations, a minimum order requirement may apply.

-XXXXX designates material (1215, 1285, etc). Refer to Chomerics Conductive Elastomer EMI Gaskets Molded and Extruded Materials Selector Guide for details. Note that these parts are available only in Cho-Seal materials with the "M" (Molded) format.

* "X" should be replaced by applicable MIL-DTL-83528 material type (e.g., A, B, C, etc.). Number in bracket is MIL-DTL-83528 slash sheet. Number in parentheses is MIL-DTL-83528 dash number. Insert them (without brackets or parentheses) to complete MIL P/N.

Conductive Elastomer Jam Nut EMI Seals

JAM NUT EMI Seals

MIL-C-38999, MIL-C-26482, and MIL-C-81511 rear-mounting jam nut receptacles require a Mil Spec (MS) O-ring as a moisture-pressure seal. When EMI attenuation is also required, CHO-SEAL O-rings should be used. Each is interchangeable with the corresponding MS O-ring.



ORDERING PROCEDURE

Select the part number from Table 7-21. Table 7-22 provides general tolerances for jam nut EMI seals.

Jam Nut EMI Seals - Product Information

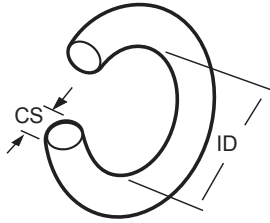

Table 7-22: Jam Nut EMI Seals Tolerances

DIMENSIONS inches (mm)	TOLERANCES inches (mm)
Inside Diameter (ID)	
≤1.500 [38.10]	±0.010 [0.25]
1.501-2.000 [38.10-50.80]	±0.015 [0.38]
Cross Section Diameter (CS)	
0.070 [1.78]	±0.004 [0.10]
0.103 [2.62]	±0.005 [0.13]

Table 7-21: Jam Nut EMI Seals

JAM NUT EMI SEALS						
Shell Size	Chomerics P/N*	MIL-C-38999JS1N1 MIL-C-26482GS1A5	Reference MIL-C-81511FS1	MIL P/N: M83528/002X [†] - ()	Nominal Dimensions inches (mm)	
					ID	CS
6	30-03-2065-XXXXX	√		015	0.551 (14.00)	0.070 (1.78)
8	30-03-2066-XXXXX	√		017	0.676 (17.17)	0.070 (1.78)
	30-03-2075-XXXXX		√	018	0.739 (18.77)	0.070 (1.78)
9, 10	30-03-1981-XXXXX	√		019	0.801 (20.35)	0.070 (1.78)
	30-03-2076-XXXXX		√	020	0.864 (21.95)	0.070 (1.78)
11, 12	30-03-2068-XXXXX	√		022	0.989 (25.12)	0.070 (1.78)
13, 14	30-03-2069-XXXXX	√	√	024	1.114 (28.30)	0.070 (1.78)
15, 16	30-03-2070-XXXXX	√	√	026	1.239 (31.47)	0.070 (1.78)
17, 18	30-03-2071-XXXXX	√	√	028	1.364 (34.65)	0.070 (1.78)
19, 20	30-03-2072-XXXXX	√		128	1.487 (37.77)	0.103 (2.62)
21, 22	30-03-1846-XXXXX	√		/005X [†] -022	1.612 (40.94)	0.103 (2.62)
23, 24	30-03-2031-XXXXX	√		132	1.737 (44.12)	0.103 (2.62)
25	30-03-8800-XXXXX			134	1.862 (47.30)	0.103 (2.62)

Note: Slight size variations exist between several series within a given MIL-SPEC. It is recommended that gasket(s) be selected on the basis of gasket dimensions which match groove dimensions.

* -XXXXX designates material (1215, 1285, etc). Refer to Chomerics Conductive Elastomer EMI Gaskets Molded and Extruded Materials Selector Guide for details. Note that these parts are available only in Cho-Seal materials with the "M" (Molded) format.

[†] "X" should be replaced by applicable MIL-DTL-83528 material type (e.g. A, B, C, etc.). MIL-DTL-83528 dash number should be inserted (without parentheses) at end of MIL P/N.

Conductive Elastomer Molded Reinforced Seals

CHO-SEAL REINFORCED ELASTOMER SEALS

CHO-SEAL reinforced conductive and non-conductive elastomer seals consist of a corrosion-resistant CHO-SEAL conductive or non-conductive elastomer base, reinforced with a woven or knitted fabric material, or wire mesh. These seals are intended for use in airframe shielding applications or any other applications requiring a reinforced seal. The integrally molded reinforced material provides improved mechanical properties, while maintaining the electrical properties of the conductive elastomer base materials.

CHO-SEAL reinforced seals are used to provide EMI shielding, lightning protection, HIRF protection and radar cross section reduction by maintaining surface electrical continuity at joints, seams and openings in air frames.

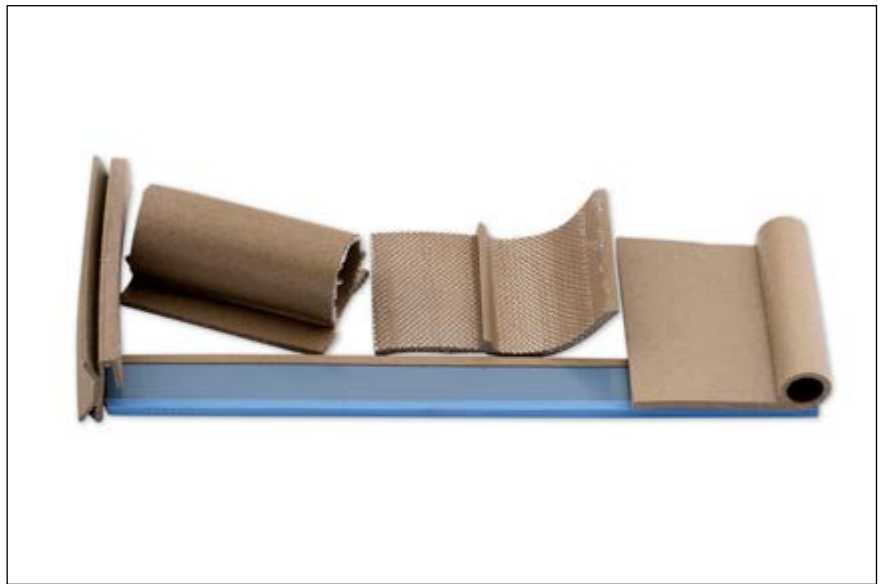

Typical applications include, but are not limited to; electronic bay doors, wing panel access covers, engine pylons, radomes and nacelle seals.

Parker Chomerics can design and develop reinforced custom cross sections, shapes and sheets to meet specific customer requirements.

CHO-SEAL 1285, CHO-SEAL 6502, CHO-SEAL 1287, CHO-SEAL 1298 and CHO-SEAL 6503 corrosion-resistant silver-plated-aluminum and silver-plated nickel filled standard Mil/Aero silicones and fluorosilicones are typically used for the conductive elastomer base material.

Knitted Dacron fabrics are used as reinforcing layers to dramatically increase the tensile and tear strength of the elastomer without adding weight to the seal. If applicable, layers of aluminum or wire mesh are used to provide high current-carrying capability required for lightning strike protection. Other reinforcing materials are available to provide resistance to flame.

Refer to Parker Chomerics Conductive Elastomer EMI Gaskets Molded and Extruded Materials Selector Guide for details

Molded Reinforced Elastomer Seals - Product Information

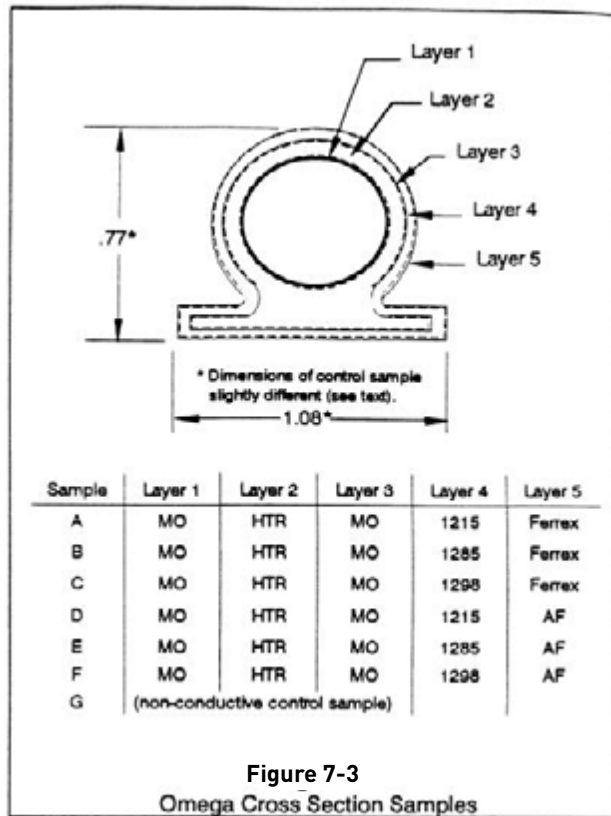

Figure 7-3

Omega Cross Section Samples

For applications on aluminum with conductive materials in salt fog environments, Parker Chomerics recommends that mating flange surfaces be protected with CHO-SHIELD® 2001 or 2002 conductive coatings for maximum corrosion protection. (See Parker Chomerics Conductive Compounds brochure for additional information.)

Table 7-23: Typical Non-Conductive Environmental Sealing Molded Elastomers

Silicone Per A-A-59588 (ZZ-R-765) Class 2A and 2B	Fluorosilicone Per MIL-R-25988B Type 2, Class 1
Grade	Grade
40	40
50	50
60	60
70	70
80	80

ORDERING PROCEDURE

CHO-SEAL Reinforced Conductive Elastomer Seals are produced as custom orders. Contact Parker Chomerics Applications Engineering Department to review your requirements.

Molded In-Place Cover Seals

MOLDED-IN-PLACE COVER SEALS

Parker Chomerics conductive elastomer seals have been chosen for airborne, shipboard and ground based electronics equipment to meet high levels of shielding and environmental sealing requirements. In hundreds of applications, Parker Chomerics has molded our conductive elastomers onto covers machined by Parker Chomerics or provided by our customers to create a permanent seal/cover assembly with significant shielding, installation and maintainability benefits.

Parker Chomerics has in-house CNC machining capability, for fast, economical turn-around of prototypes, and developmental modifications of structural components, as well as full production capacity for components and seal assemblies. Incorporating our corrosion-resistant, silver-plated or nickel-plated aluminum filled silicones and fluorosilicones, these assemblies are particularly suited for environmentally demanding military/aerospace applications.

START WITH SUPERIOR MATERIALS

Our corrosion-resistant CHO-SEAL® 1285 and 1298 silver/aluminum and CHO-SEAL 6502 and 6503 nickel/aluminum gasket materials provide 90dB of shielding effectiveness at 1 GHz, excellent salt-spray resistance (MIL-STD 810), EMP survivability and a - 55° to 200°C use temperature range. Enclosure shielding and environmental sealing performance are improved in a number of ways when conductive elastomer gaskets are molded directly to a flange surface instead of being adhesively bonded or mechanically attached.

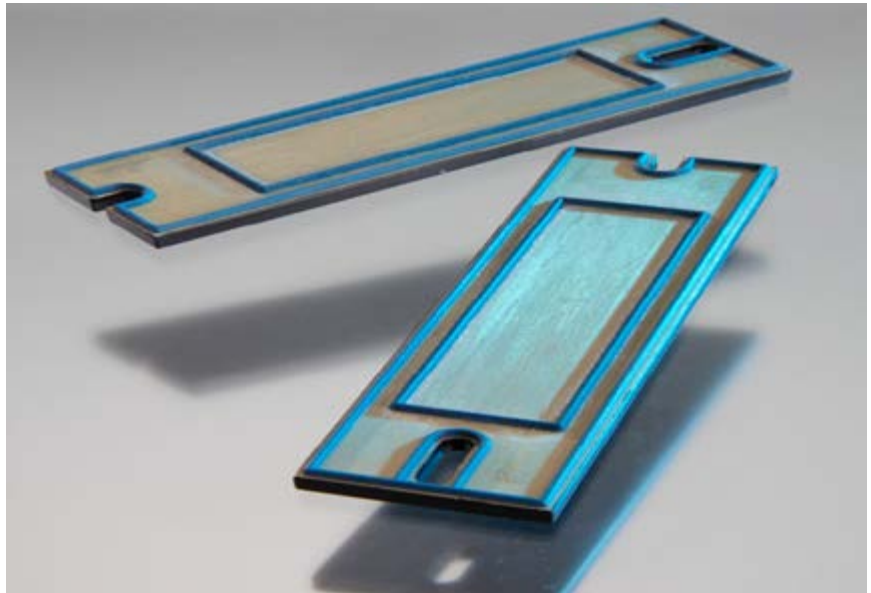

A Molded-In-Place gasket permits the optimum seal profile to be formed, achieving more gasket deflection with limited closure force when compared to flat, bonded gaskets. Eliminating the adhesive reduces interface resistance and maximizes shielding effectiveness. It also improves environmental sealing by eliminating the uncontrollable variations in adhesive thickness that may turn theoretically good designs into field failures.

Design and Cost Advantages

Molded-In-Place seal/cover assemblies also offer the following advantages over extruded or die-cut gaskets:

- **Gasket Volume** — typically less seal material is needed compared to die-cut gaskets, thereby reducing costs in many applications.
- **Cross Section Design** — compression/deflection requirements can be met with fewer fasteners, resulting in improved maintainability.

- **Fastener Sealing** — allows fasteners to be designed inboard or outboard of the gasket more easily, reducing both EMI and moisture leakage into the enclosure through fastener holes.
- **Production Savings** — the gasket, cover and compression stops become a single part, reducing the number of purchased items, inventory and documentation.
- **Installation Savings** — inconsistent and expensive adhesive bonding operations are eliminated.
- **Field Reliability and Maintainability** — damaged gaskets or covers become a 1-part replacement with little potential for error. Also, conductive gaskets will not be replaced mistakenly with ordinary non-conductive gaskets during routine maintenance.

Molded In-Place Cover Seals - Product Information

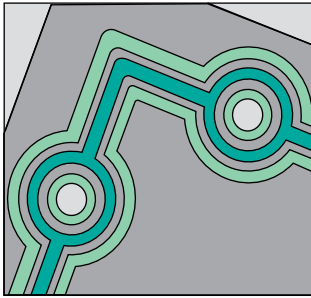

This gasket design provides the ultimate protection in harsh environments. A non-conductive elastomer is molded around the bolt holes, and both inboard and outboard of the conductive elastomer.

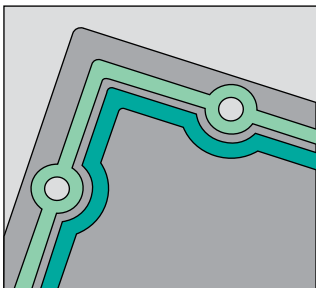

Molding a non-conductive elastomer to the outboard edge and around bolt holes further protects the inboard conductive elastomer and the enclosure in corrosive environments.

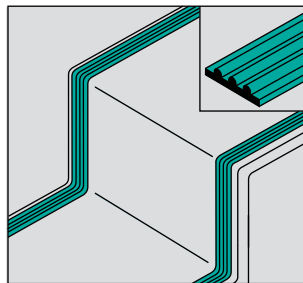

Installing conventional gaskets on enclosure covers with less than 90° bends is extremely difficult. Molding a gasket to this configuration is not only easier, but the elastomer cross section can be designed to provide maximum shielding with a lower closure force.

Table 7-24: Typical Non-Conductive Environmental Sealing Molded Elastomers

Silicone Per A-A-59588 (ZZ-R-765) Class 2A and 2B	Fluorosilicone Per AMS-R-25988 Type 2, Class 1
Grade	Grade
40	40
50	50
60	60
70	70
80	80

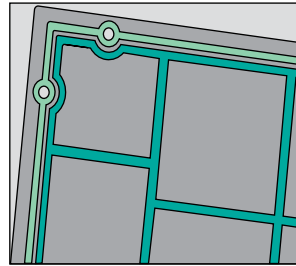

For large, complex gaskets with numerous "T" joints, an extruded gasket can be difficult to manufacture and requires adhesive bonding at every junction. A Molded-In-Place assembly provides a "seamless" gasket regardless of the configuration required.

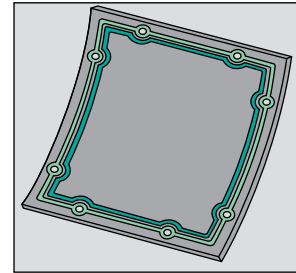

Enclosure covers with simple and compound curve configurations can also be supplied with Molded-In-Place elastomer gaskets.

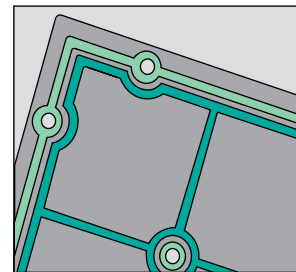

For electronic enclosures that require various compartments to be shielded from each other, a Molded-In-Place cover assembly provides maximum shielding effectiveness and simple installation.

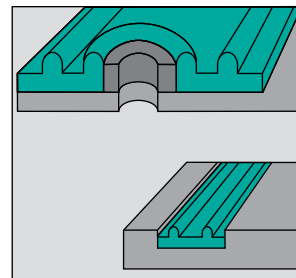

Molding-In-Place enables compression stops to be built directly into the gasket, protecting it from overcompression. Additionally, cover assembly shielding and environmental sealing performance can be improved even further by molding the gasket into a flange or cover groove.

Ordering Information

Parker Chomerics can Mold-In-Place any of the CHO-SEAL conductive elastomers. Refer to **Parker Chomerics Conductive Elastomer EMI Gaskets Molded and Extruded Materials Selector Guide** for details. Select the material that meets the performance criteria for your application. If you would like Parker Chomerics to supply your total gasket/cover assembly, send a drawing of the enclosure configuration to our Applications Engineering Department, along with your request for a quotation. If you would like us to mold CHO-SEAL elastomers to an existing cover, send a drawing or actual cover sample for evaluation. Note: Covers supplied for molding may require modification for tooling interface, and must be unpainted and unplated.

Size Limitations

Parker Chomerics can produce Molded-In-Place gasket/panel assemblies in any overall dimension larger than ¾ x ¾ in. (19 x 19 mm). Minimum recommended gasket profile cross section is 0.062 in. (1.6 mm), with a minimum thickness of 0.020 in. (0.5 mm) for flat gaskets. Smaller cross sections and thicknesses, although not recommended, can be accommodated.

Conductive Elastomer Overmolded Solutions

(Overmolding, Insert Molding, Mold-In-Place, Molded-In-Place, Overmolded EMI Seals)

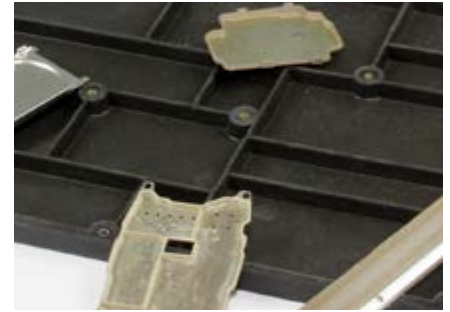

CONDUCTIVE ELASTOMER OVERMOLD-ED SOLUTIONS Parker Chomerics pioneered conductive elastomer technology in the 1960s with discrete molded and extruded product forms. Our conductive elastomer technology solutions also include injection overmolded seals on frames, components & substrate surfaces.

The Parker Chomerics value proposition includes:

- the expertise to design/supply parts with conductive elastomers directly vulcanized onto a variety of substrates
- the willingness to manage supply chain components.
- a wide range of final assembly techniques and, if requested, customized packaging.

Customers receive an integrated gasket/substrate solution assembled with all specified components that's "electronics ready" for final assembly. Parker Chomerics supplies these solutions to a wide variety of applications in the Life Science, Telecom, Military/Aerospace, Transportation and Information Technologies markets.



Many of Parker Chomerics conductive elastomer materials are ideally suited for overmolding applications (see Table 7-26 for Injection Overmolded Conductive Elastomer Specifications). An electronics application often requires a separate overmolded environmental seal or a dual EMI/environmental seal. The substrate selected must have the ability to withstand the elastomer processing temperatures up to 360°F (182°C). Metal substrates and many high temperature plastics are suitable for conductive elastomer overmolding (see typical substrate properties in Tables 7-27 and 7-28).

Parker Chomerics can offer design assistance of the entire solution including Finite Element Analysis, mold design/procurement and mold flow analysis. As an example, the MARC K6 Series software is utilized for our elastomer FEA capability. FEA supports optimized elastomer seal profiles by simulating the design under compression which allows accurate predictions and minimizes prototyping evaluations.

MOLDED

Figure 7-4 Typical FEA Example of a Custom Gasket Profile

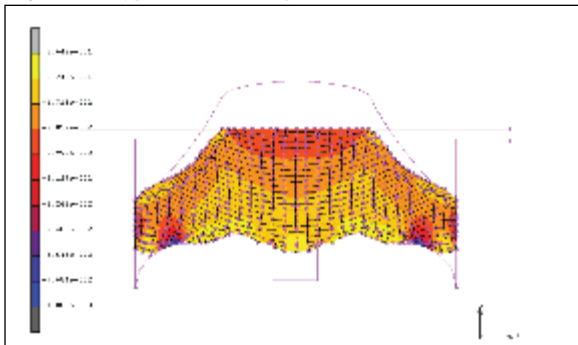

Graph 7-2 Typical Compression-Deflection Curve Predicted by FEA

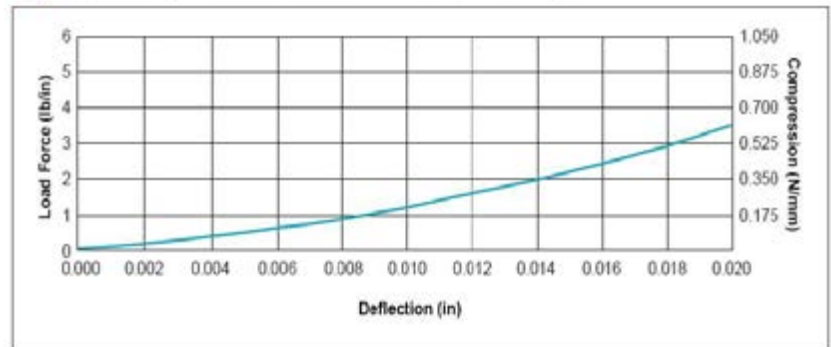

Please contact Parker Chomerics Applications Engineering for assistance with your application

Conductive Elastomer Overmolded Solutions



INJECTION OVERMOLDED SEALS ON FRAMES, COMPONENTS & SUBSTRATE SURFACES

Parker Chomerics technology for injection overmolding conductive seals on metal or plastic frames, metal castings, stampings, plastic substrates, machined housings and components can take many forms. This technology can be an ideal solution for grounding the traces of circuit boards or the edge of an internal shield (eg. metal stamping/casting) to a conductive housing, or providing a grounding point or flexible electrical contact in a discrete area. Locating pins, holes, inserts and other features to facilitate easy assembly can be integrated into the overmolded solution. Parker Chomerics can assist with design of the gasket and the metal or plastic substrate to facilitate easy assembly and optimum shielding.

Injection overmolding on a frame or the edge of a component requires careful design to ensure good elastomer adhesion. See figure 7-5 for suggested edge designs and Table 7-25 for design parameters.

Figure 7-5

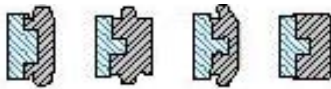



-  Frame/Substrate Edge
-  Conductive Elastomer

Table 7-25

DESIGN PARAMETERS	
Maximum overall dimension	18 inch x 18 inch (45.7 cm x 45.7 cm)
Minimum cross section	0.050 inch (1.27 mm)
Minimum frame cross section	0.020 inch (0.51 mm)
Minimum elastomer cross section	0.015 inch (0.38 mm)
Minimum frame cross-sectional area	0.001 inch ² (0.025 mm ²)
Minimum elastomer cross-sectional area	0.0020 inch ² (0.051 mm ²)
Cross section tolerance (typical)	±0.003 inch (0.076 mm)
Plan view tolerance (typical)	-0.005 inch (0.127 mm)

Conductive Elastomer Overmolded Solutions

EXAMPLES OF INJECTION OVERMOLDED SEAL APPLICATIONS

The conductive elastomer can be overmolded on the inside or outside of a frame and the top and bottom surfaces.



The overmold can be a perimeter seal on a small housing cover or an internal metal or plastic shield.

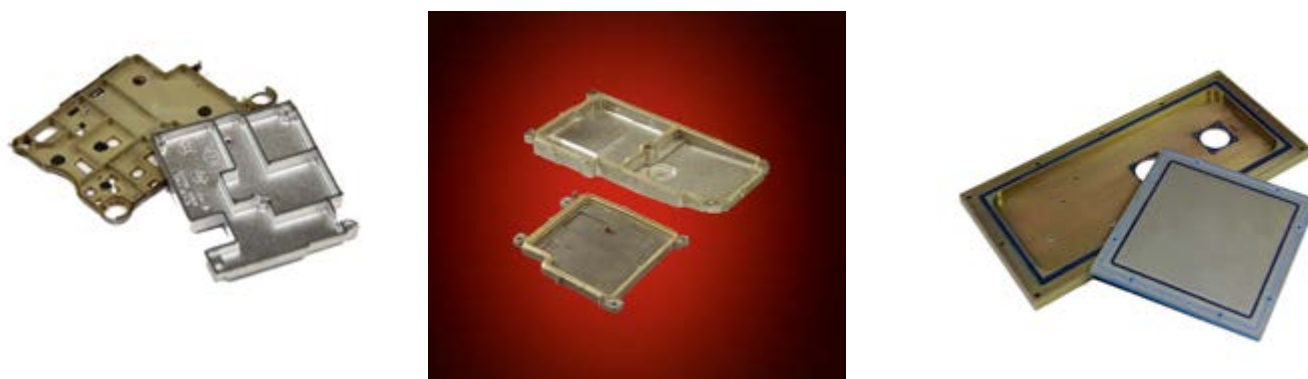

Conductive elastomer overmolds are an ideal solution for grounding the edge of internal shields to a housing wall. Successful shield substrate materials include nickel plated castings, aluminum castings, machined metal, conductive filled Ultem and Parker Chomerics PEI-140 conductive plastic. Microwave absorber pads can be added to individual cavities for further internal isolation.

MOLDED

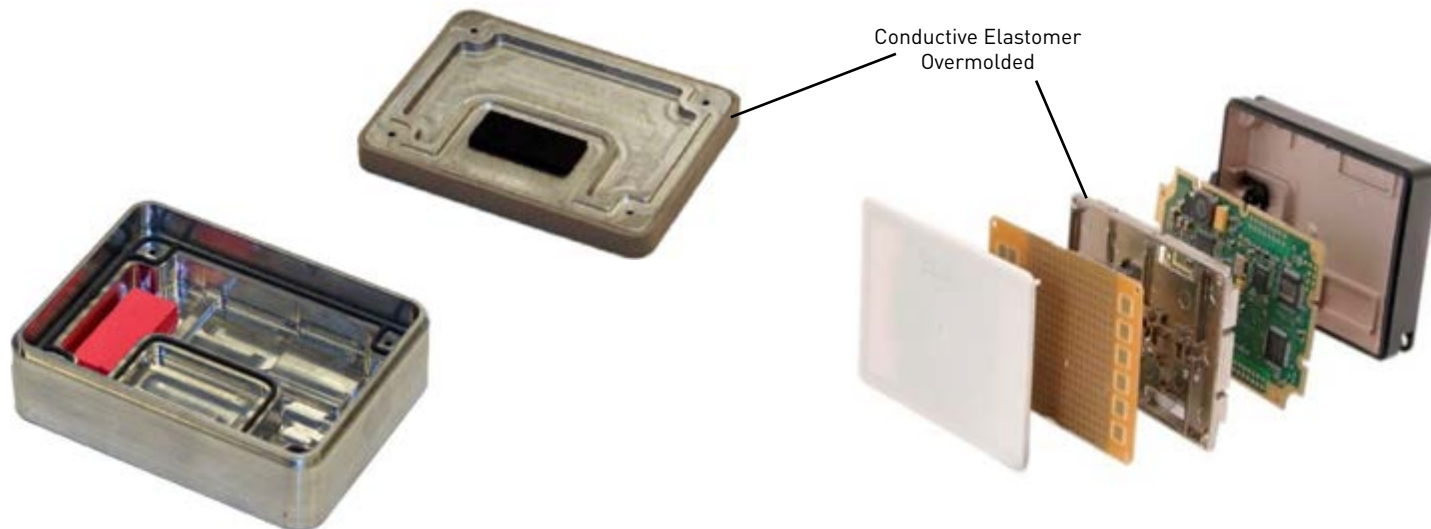

Conductive Elastomer Overmolded Solutions

Conductive elastomer overmolding can be an ideal way to provide discrete grounding points on metal surfaces or flexible electrical contacts when isolated in a high temperature plastic.

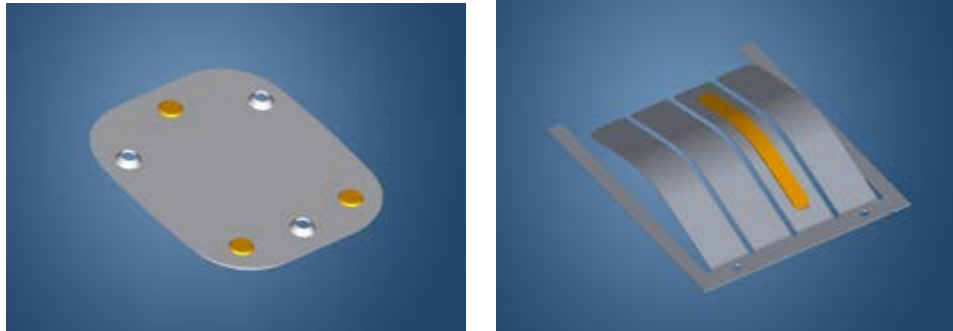

CHO-SEAL 1273 overmolded on metal stampings provide discrete grounding points.



CHO-Seal 1310 insert molded on plastic substrates provide flexible electrical contacts useful in switching and charging applications.

Conductive Elastomers can be overmolded on substrate surfaces of internal metal or plastic components to provide effective EMI shielding at the board level. This solution can eliminate soldered metal can shields, EMI secondary coatings on a plastic housing or an internal shielding laminate.

The overmold can be a uniform thickness on all or part of a surface and can include thin flexible walls that provide cavity or printed circuit board isolation. Customers get a low closure design while maintaining the ability to advertise recyclable plastic housings.

Conductive Elastomer Overmolded Solutions

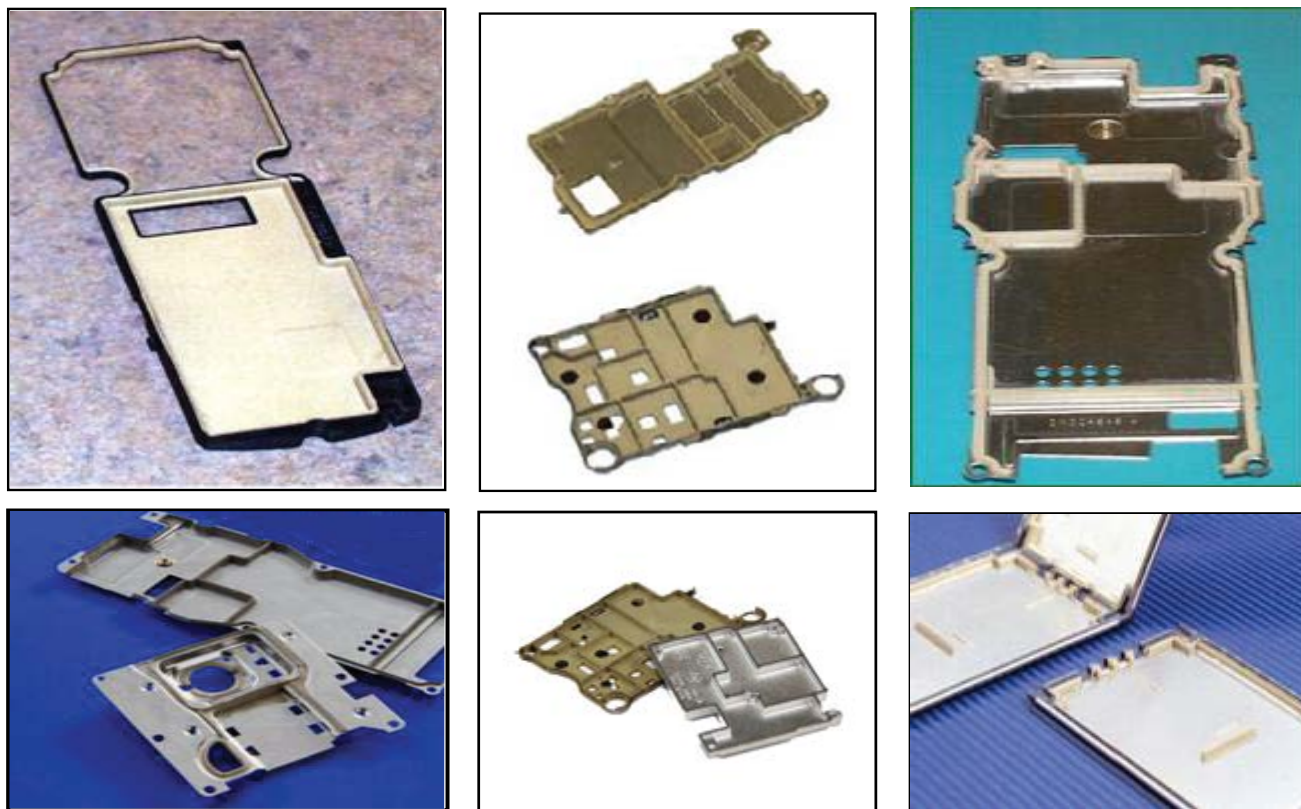

Table 7-26

SELECTED OVERMOLDED CONDUCTIVE ELASTOMER SPECIFICATIONS					
Property	Test Procedure	CHO-SEAL 1310	CHO-SEAL 1273	CHO-SEAL 1285	CHO-SEAL S6305
Elastomer Binder	—	Silicone	Silicone	Silicone	Silicone
Conductive Filler	—	Ag/Glass	Ag/Cu	Ag/Al	Ni/C
Volume Resistivity (ohm-cm), max	CEPS-0002*	0.010	0.004	0.008	0.100
Hardness (Shore A)	ASTM 2240	70 ±10	65 ±8	65 ±7	65 ±10
Specific Gravity	ASTM D792	1.8 ±0.25	3.70 ±0.25	2.00 ±0.25	2.00 ±0.25
Tensile Strength, psi, min. (MPa, min)	ASTM D412	200 (1.38)	175 (1.21)	200 (1.38)	200 (1.38)
Elongation, %, min.	ASTM D412	100	75	100/300	100
Compression Set, 70 hrs. @ 100°C. %, max.	ASTM D395 Method B	35	32	32	30
Shielding Effectiveness 100 MHz (E-Field) 100 500 MHz (E-Field) 100 2 GHz (Plane Wave) 90 10 GHz (Plane Wave)	CHO-TP08*	100 100 90 80	100 100 100 100	115 110 105 100	100 100 100 100
Volume Resistivity After Heat Aging, ohm-cm, max.	CEPS-0002*	0.01	0.010	0.010	0.250

* Copies of CEPS-0002 and CHO-TP08 are available from Parker Chomerics Applications Engineering.

Contact Parker Chomerics Applications Engineering for assistance with elastomer selection and design guidance. Refer to Parker Chomerics Conductive Elastomer EMI Gaskets Molded and Extruded Materials Selector Guide for further details.

MOLDED

Conductive Elastomer Overmolded Solutions

Table 7-27

TYPICAL PROPERTIES OF SELECTED THERMOPLASTIC COVERS (without plating ⁵)				
Property	Test Procedure	Vectra A130 LCP ¹	IXEF 1032 PAA ²	ULTEM 1000 PEI ^{3,4}
Tensile Strength, yield, Type 1, 0.125 inch (3.2 mm), psi (MPa)	ASTM D638	30,000 (207)	40,600 (280)	20,100 (139)
Tensile Elongation, break, Type 1, 0.125 inch (3.2 mm), %	ASTM D638	2.2	1.8	3.0
Flexural Strength, break, 0.125 inch (3.2 mm), psi (MPa)	ASTM D790	37,000 (254)	58,000 (400)	30,000 (207)
Flexural Modulus, 0.125 inch (3.2 mm), psi (MPa)	ASTM D790	2,100,000 (15,000)	3,050,000 (21,000)	900,000 (6,200)
Compression Strength, psi (MPa)	ASTM D695	20,000 (140)	NA	28,700 (198)
Compression Modulus, psi (MPa)	ASTM D695	1,700,000 (12,000)	NA	809,000 (5,575)
Izod Impact, notched, 73°F (23°C), ft-lb/in (J/m)	ASTM D256	2.8 (150)	2.25 (120)	1.6 (85)
HDT, 66 psi (0.45 MPa), 0.250 in., (6.4 mm), unannealed, °F (°C)	ASTM D648	489 (254)	446 (230)	410 (210)
Specific Gravity	ASTM D792	1.61	1.77	1.42
Volume Resistivity, ohm-cm	ASTM D257	10 x 10 ¹⁵	2.0 x 10 ¹⁵	70 x 10 ¹⁵
UL 94V-0 Flame Class Rating, inch (mm)	UL 94	0.018 (0.45)	HB Rated	0.016 (0.40)
Limiting Oxygen Index (LOI), %	ASTM 2863	37	25	50

¹ Celanese AG² Solvay SA³ Sabic Innovative Plastics⁴ Parker Chomerics PEI-140 conductive plastic as well as other conductively filled versions of Ultem 1000 may be considered. Contact Parker Chomerics for design guidance.⁵ Electroless or electrolytic plating may be applied to plastic substrates when conductive surfaces are required.

Table 7-28

TYPICAL PROPERTIES OF METAL SUBSTRATES			
Property	Aluminum Die Casting	Thixo-Molded Magnesium	Stainless Steel
Alloy Number	A380.0	AZ91D-F	316L
Tensile Strength, yield, psi (MPa)	23,055 (159)	21,750 (150)	42,800 (295)
Elongation, %, break	3.5	3	46
Modulus of Elasticity, ksi (GPa)	10,295 (71)	6,496 (44.8)	29,000 (200)
Fatigue Strength, psi (MPa)	20,010 (138)	14,065 (97)	NA
Shear Modulus, ksi (GPa)	3,843 (26.5)	2,465 (17)	NA
Electrical Resistivity, ohm-cm	0.0000064	0.000017	0.000000074
Density (g/cc)	2.76	1.81	NA

NA = Not Applicable

Contact Chomerics regarding alternative metal substrates

CHOFORM® and ParPHorm® Form-in-Place EMI Gasketing



Customer Value

Proposition:

Parker Chomerics CHOFORM Automated EMI Gasketing System is ideal for today's densely populated electronics packaging, particularly where intercompartmental isolation is required to separate processing and signal generating functions. CHOFORM is directly dispensed on castings, machined metal and conductive plastic housings and board shields. It provides excellent electrical contact to mating conductive surfaces including printed circuit board traces. CHOFORM is widely used in compartmentalized enclosures and other tightly packaged electronic devices in military, telecom, transportation, aerospace and life science applications.

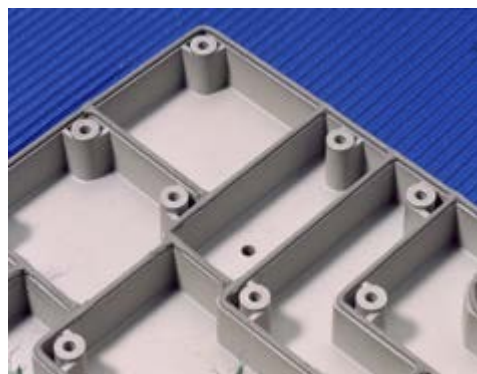

The CHOFORM technology allows dispensing of precisely positioned, conformable gaskets in very small cross sections that free valuable package space. They provide the lowest total cost of ownership for small cross section and complex pattern applications. Parker Chomerics CHOFORM and ParPHorm® Form-In-Place (FIP) materials can reduce installed cost of an EMI gasket by up to 60%. The durable, highly conductive seals have low compression set, ensuring years of effective EMI shielding and mechanical performance.

With gasket dispensing primarily software driven, CHOFORM technology permits rapid prototyping, changes in design, and production scale-up at nominal cost. Its inherent flexibility accommodates batch runs or continuous production, from ten to ten million parts. Wide acceptance of the CHOFORM automated gasket dispensing system can be attributed to a successful blend of manufacturing and materials expertise. The CHOFORM technology combined with a Parker Chomerics supplied metal or conductive plastic housing or board shield provides an integrated solution ready for the customers' highest level of assembly. Individual compartment shielding or grounding is often enhanced by placement of a secondary EMI product such as a short length of fingerstock, fabric over foam, conductive extrusion gasket or a microwave absorber. Thermal transfer from the printed circuit boards' heat generating devices to a metal housing wall or board shield can be accomplished by placement of a soft thermally conductive gap filler, dispensed thermal compound or gel.

Parker Chomerics has the technology to support all of these application needs in a one stop integrated solution. Contact Parker Chomerics Applications for further details and assistance.

Product Features:

- Up to 60% space saved -flanges as narrow as 0.025" (0.76mm) can be gasketed.
- More than 100 dB shielding effectiveness from 200 MHz to 12 GHz with very small gasket beads.
- Excellent adhesion to common housing substrates and coatings.
- Highly compressible gaskets, ideal with limited deflection force.
- Quick turn-around of prototypes and samples. Parts typically prototyped and shipped within several days and typically do not require tooling.

Excellent Shielding Effectiveness, even in small cross sections, shielding effectiveness of CHOFORM gaskets exceeds 100 dB between 200 MHz and 12 GHz. Shielding performance increases with cross sectional dimensions. Results shown for various CHOFORM materials were obtained using Parker Chomerics standard bead size of 0.034 inch high by 0.040 inch wide (0.86 mm high by 1.0 mm wide)

Denser Packaging is Possible CHOFORM gaskets can be applied to walls or flanges as narrow as 0.025" (0.76 mm), and don't require mechanical retention. Compared with groove and friction-fit designs, the positional accuracy and self adhesive properties of CHOFORM gaskets will typically save 60% or more space. This frees additional board space, and allows for smaller overall package dimensions.

Small Cross Sections, Complex Geometries Virtually any gasket bead path can be programmed using CHOFORM application technology. In addition to simple straight lengths, the system applies continuous 360° perimeter gaskets in combination with any required number of internal subpaths that form "T" joints with the perimeter seal. The system produces reliable junctions between bead paths that provide continuous EMI shielding and environmental sealing.

Low Closure Force Not a Problem CHOFORM gasket materials are ideal for low deflection force designs, or those whose mating surfaces have low mechanical rigidity. Nominal deflection of 30% using a mechanical compression stop is recommended. Deflection below 20% or above 40% is not recommended. An example of typical compression-deflection data for for CHOFORM materials appears in Graph 8-1.

Secure Gasket Adhesion CHOFORM gaskets typically exhibit 4-12 N/cm of shear adhesion to a variety of common housing substrates, Including:

- cast aluminum, magnesium or zinc alloys with various platings*
- nickel-copper plating on plastic stainless steel (300 series)
- CHO-SHIELD® 2056, 610, 2040 or 2044 conductive coatings
- Vacuum metallized aluminum

* CrO₂, black chrome, black nickel, bright nickel, tin

Gasket Application Fully Programmable in 3 Axes Full 3-axis motion of the CHOFORM application technology accommodates uneven surfaces (with a maximum slope of 60° common in castings or injection-molded parts). The result is enhanced control of the gasket cross section.

Tight Dimensional Control and Terminations CHOFORM gasket beads are dispensed with an accuracy of 0.001 inch (0.025 mm), and a cross-sectional height tolerance of 0.006 inch (0.15 mm). This innovative technology produces clean bead ends minimizing the "tail" characteristic of other processes. The key is precise management of flow rate of material through the nozzle, material viscosity and dispensing speed.

Note: Gasket cross section and tolerances will vary slightly at the site of 'start' or 'stop' events in the dispense bead length.



Gasket application to sloped surfaces is fully programmable

Graph 8-1 Deflection vs Applied Load

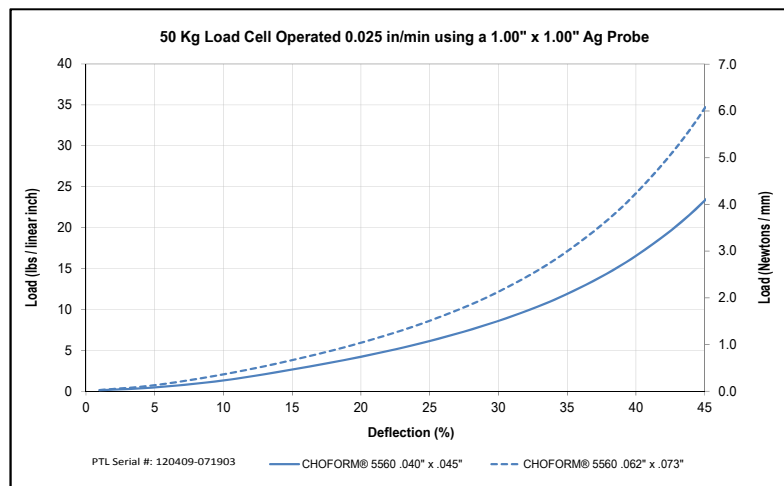



High Levels of Quality Control

Parker Chomerics has the capability to perform automated dimensional verification of gasket bead placement and height for statistical process control, using fully programmable optical coordinate measuring technology and vision systems. Electrical resistance of cured gasket material is tested with a multimeter capable of measuring to 0.001 ohm. Typical C_p and C_{pk} values are approximately 1.5.



UL 94-V0 RATED MATERIALS

Chomerics introduced the first conductive elastomer gasket material with a UL 94 V-0 rating. Since that time, Chomerics now has a selection of UL 94 V-0 rated gasket materials including Cho-Form 5513, 5541, 5550 and 5560. Cho-Form gasket materials are rated at UL 94 V-0 down to a thickness of 0.016 Inch (0.42 mm). Actual thickness for each certified material, and specific conditions of use can be found in UL File #OCDT2.E140244 under Insulating Devices and Materials – Components. Cho-Seal materials certified by UL for use in Canada can be found in UL File OCDT8.E140244. For UL Certification files, please visit www.ul.com.

A Choice of Materials Formulated for Automated Dispensing

CHOFORM materials typically establish 4-12 N/cm adhesion to many substrates, including magnesium and aluminum alloys and commonly used conductive films such as Ni/Cu plating, vacuum metallized coatings and conductive paints. Producing durable, conformable gaskets, all CHOFORM materials can be applied as small as 0.034 inch high and 0.040 inch wide (0.86 mm high and 1.02 mm wide), delivering C_{pk} values >1.33.*

CHOFORM 5513 — Two-component, thermal cure silicone system, which requires a minimum cure of 30 minutes at 140°C (284°F). The Ag/Cu particle filler makes 5513 a > 70 dB shielding material while also having the best adhesion to chromate coated aluminum and most other substrates.

CHOFORM 5541 — One-component, thermal cure silicone system, which requires a minimum cure of 30 minutes at 150°C (302°F). The low cost Ni/Graphite filler makes 5541 a >65 dB shielding material while also providing a good galvanic corrosion resistant gasket when mated with aluminum for outdoor applications. 5541 has very good adhesion properties.

CHOFORM 5550 — One-component, thermal cure silicone system, which requires a minimum cure of 30 minutes at 150°C (302°F). The low cost Ni/Graphite filler makes 5550 a >65 dB shielding material while also providing a good galvanic corrosion resistant gasket when mated with aluminum for outdoor applications. The key property in 5550 is its lower hardness than 5541, however this softer material requires a larger minimum bead size.

CHOFORM 5575 - One component, moisture cure silicone system, which can be used in high temperature environments up to 125° C (257 °F). Its silver plated aluminum filler delivers superior galvanic corrosion resistance on aluminum substrates which may eliminate the need for additional plating or secondary environmental gaskets.

CHOFORM 5526 — One-component, room temperature, moisture cure silicone system, which requires a full cure of 24 hours at 50% relative humidity. The pure silver filler makes 5526 our best shielding material at > 100 dB, while providing a soft, low closure force gasket.

CHOFORM 5528 — One-component, room temperature, moisture cure silicone system, which requires a full cure of 24 hours at 50% relative humidity. The Ag/Cu filler makes 5528 a >70 dB shielding material, while providing a soft, low closure force gasket.

CHOFORM 5538 — One-component, room temperature, moisture cure silicone system, which ONLY requires a full cure of 4 hours at 50% relative humidity. The low cost Ni/Graphite filler makes 5538 a >65 dB shielding material while also providing a good galvanic corrosion resistant gasket when mated with aluminum for outdoor applications. 5538 is also capable of the smallest possible bead size.

CHOFORM 5560 — One-component, thermal cure silicone system, which requires a minimum cure of 30 minutes at 150°C (302°F). The Ni/Al filler makes 5560 a very good >90 dB shielding material while also providing the best galvanic corrosion resistant gasket when mated with aluminum for even the harshest salt spray / salt fog environments.

*Exception: CHOFORM 5560 has a minimum applied height of 0.039 inch high and 0.045 inch wide (0.99 mm high and 1.14 mm wide. Refer to Table 8-3 “Typical Properties of CHOFORM Materials” for all minimum and maximum bead sizes.

ParPHorm is a family of non-conductive, thermal and moisture cure, form-in-place, elastomeric sealing compounds. These silicone and fluorosilicone materials provide environmental, fluid, and dust sealing of small enclosures. The product line consists of state-of-the-art compounds designed to be robotically dispensed onto small housings and then cured. Curing of the dispensed materials is done via in-line ovens at 284° F (140° C) for 30 minutes. Dispensed bead heights range from 0.018 in. (0.46 mm) to 0.062 in. (1.57 mm). Application advantages of the materials are resistance to a wide variety of fluids, excellent substrate adhesion, low hardness, and outstanding compression set properties. Refer to Table 2b.

DESCRIPTION - Thermal Cure Materials

ParPHorm S1945

ParPHorm S1945 is a silicone FIP material with lower hardness (Shore A 25) and excellent compression set (21%). ParPHorm S1945 is especially designed for low closure force applications and those requiring exceptional adhesion properties. Due to its minimal hardness, S1945, is one of the most widely used ParPHorm materials and thus has extensive application in many areas. The compound adheres well to aluminum, phenolic resins, copper, stainless steel, glass, rigid PVC, most ceramics, and various plastics. ParPHorm S1945 is compatible with air below 400° F, ethylene glycol, nitrogen, sea (salt) water, magnesium sulfite and sulfate, citric acid, methanol, ozone, soap solutions, zinc salts and zinc sulfates, potassium chloride/nitrate, barium chloride/hydroxide/salts, sodium chloride/salts/sulfates, and glycols.

ParPHorm L1938

ParPHorm L1938 is a fluorosilicone FIP elastomer with Shore A hardness of 45 and compression set rating of 14%. This fluorosilicone material offers additional fluid resistance capabilities above and beyond the capabilities of S1945.

FEATURES

- One component thermal cure materials
- Excellent resistance to a wide variety of fluids
- Excellent adhesion to a wide variety of substrates
- Low material and installation costs

HANDLING AND CURING OF MATERIAL

ParPHorm S1945, and L1938 are one component, thermal cure materials. Recommended cure temperature is 284° F (140° C) for 30 minutes. The full cure cycle of 30 minutes allows for immediate handling, and performance of necessary QC tests. The use of this thermal cure, form-in-place material reduces the need for dispensed parts storage space. This also allows for immediate packaging and shipment of parts to their final destination for subsequent integration into the equipment assembly process.

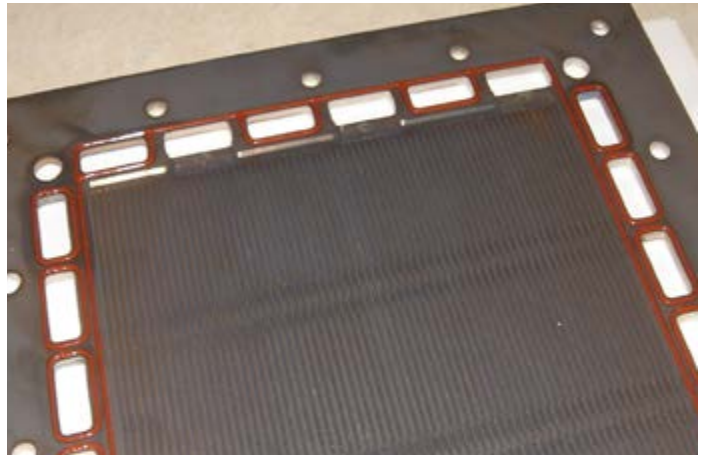

DESCRIPTION - Moisture Cure Materials

ParPHorm 1800

ParPHorm 1800 is a non-conductive, moisture cure, form-in-place (FIP), silicone elastomer sealing material. The material provides environmental, fluid, and dust sealing of small enclosures via a compound designed to be robotically dispensed onto small housings. Curing of the dispensed material is via moisture cure for 48 hours. Minimum bead size is 0.018" (0.46 mm) tall by 0.022" (0.56 mm) wide. Maximum bead size is .062" (1.57 mm) tall by 0.075" (1.91 mm) wide. Application advantages of the material are excellent adhesion, low hardness, and excellent compression set properties. Applications for ParPHorm 1800 material include handheld electronic module housings, battery cases, industrial gauges, fuel cells, and other enclosures requiring small dispensed elastomer seals for environmental or fluid sealing. Parker Chomerics offers worldwide capabilities for dispensing of this material onto customer supplied housings. Parker Chomerics can also provide supply chain management of the process and source the housings along with ParPHorm dispensing and finishing operations such as painting and minor mechanical assembly.

FEATURES

- One component moisture cure material
- Excellent resistance to a wide variety of fluids
- Excellent adhesion to a wide variety of substrates
- Low material and installation costs

HANDLING AND CURING OF MATERIAL

ParPHorm 1800 is a one component, moisture cure material. Recommended cure condition is 22° C , 50% RH for 24 hours. For these same temperature and humidity conditions the tack free time is approximately 18 minutes and handling time is 4 hours.



DESIGN AND PROTOTYPING

Application and design assistance is available to prospective customers. The specific focus of the assistance is on the examination/identification of design issues with regard to the substrate. These design issues include: enclosure material and surface finish, available gasket placement area, material selection, part flatness, transitions in the layout of the dispensed bead, obstructions in the design of the enclosure to the unimpeded travel of the dispense needle, and z direction dispense needs. Prototype dispensing is available on sample parts or sample coupons for customer evaluation.

MATERIAL DISPENSING

CHOFORM and ParPHorm are easily dispensed from a variety of commercially available gasket dispense systems. In addition to Parker Chomerics existing worldwide network of CHOFORM applicators, our CHOFORM applications engineering group can provide support for material dispense needs worldwide for customers wishing to utilize their own or other dispense equipment.

Table 8-1 - CHOFORM Ordering Information

Material	Part Number	Material Weight	Packaging Type = Size
5513	19-26-5513-0850	Part A 450 grams Part B 475 grams	12 fl. oz. SEMCO Tube
5526	19-26-5526-0850	850 grams	12 fl. oz. Aluminum Cartridge
5528	19-26-5528-0850	850 grams	12 fl. oz. Aluminum Cartridge
5538	19-26-5538-0650	650 grams	12 fl. oz. Aluminum Cartridge
5541	19-26-5541-0650	650 grams	12 fl. oz. Aluminum Cartridge
5550	19-26-5550-0575	575 grams	12 fl. oz. Aluminum Cartridge
5560	19-26-5560-0500	500 grams	12 fl. oz. Aluminum Cartridge
5575	19-26-5575-0240 19-26-5575-0500	240 grams 500 grams	6oz. SEMCO Tube 12 fl. oz. SEMCO Tube

Samples typically provided in 30cc syringes

Table 8-2 - ParPHorm Ordering Information

Material	Part Number	Material Weight	Packaging Type = Size
1800	19-26-1800-0345	345 grams	12 fl. oz. Aluminum Cartridge
1938	19-26-1938-0200	200 grams	6 fl. oz. SEMCO Tube
1945	19-26-1945-0250	250 grams	12 fl. oz. SEMCO Tube

SEMCO is a registered trademark of PRC-DeSoto, Inc.

Table 8-3

CHOFORM® - Conductive Form-In-Place Gaskets						
Typical Properties	Test Procedure	Units	CHOFORM® 5513	CHOFORM® 5541	CHOFORM® 5550	CHOFORM® 5560
Features	--	--	Excellent electrical properties and adhesion	Corrosion resistant, high temp	Soft Ni/C, corrosion resistant	Excellent corrosion resistance on Aluminum
Conductive Filler	--	--	Ag/Cu	Ni/C	Ni/C	Ni/Al
Resin System	--	--	Silicone	Silicone	Silicone	Silicone
Number of Components	--	--	2	1	1	1
Cure System	--	--	Thermal	Thermal	Thermal	Thermal
Cure Schedule						
Tack Free Time	--	--	30 mins @ 140° C	30 mins @ 150° C	30 mins @ 150° C	30 mins @ 150° C
Handling Time			30 mins @ 140° C	30 mins @ 150° C	30 mins @ 150° C	30 mins @ 150° C
Full Cure			30 mins @ 140° C	30 mins @ 150° C	30 mins @ 150° C	30 mins @ 150° C
Hardness	ASTM D 2240	Shore A	53	75	55	55
Tensile Strength	ASTM D 412	psi	350	500	175	165
Elongation	ASTM D 412	%	255	125	175	150
Specific Gravity	ASTM D 395	--	3.4	2.4	2.2	1.8
Volume Resistivity	Chomerics MAT-1002	Ω-cm	0.004	0.030	0.035	0.13
Galvanic Corrosion Resistance Against Alum	Chomerics TM-100	Weight Loss mg	NR	32	20	4
*Compression Set 22 hrs @ 70° C	ASTM D 395 Method B	%	28	30	25	25
Maximum Use Temp	--	°C (°F)	125 (257)	125 (257)	125 (257)	125 (257)
Flammability Rating	UL 94	--	V-0	V-0	V-0	V-0
Shielding Effectiveness (avg 200 MHz - 12 GHz)	Modified IEEE-299	dB	>70	>65	>65	>90
Adhesion Trivalent Chromate Coating on Alum	Chomerics WI 038	N/cm	20	18	12	6
Force Deflection @ 30% Compression 0.034" x 0.040" sized bead (0.86 mm x 1.02 mm)						
English	ASTM D 375 Mod	lb-f/in	60	81.0	32.4	12.5
Metric	ASTM D 375 Mod	N/cm	105.1	141.8	56.7	21.9
Bead Size Smallest Recommended Largest Recommended (single pass)	Height by Width Height by Width	inches (mm) inches (mm)	0.018 x 0.022 (0.46 x 0.56) 0.062 x 0.075 (1.57 x 1.91)	0.026 x 0.032 (0.66 x 0.81) 0.059 x 0.070 (1.50 x 1.80)	0.038 x 0.045 (0.96 x 1.14) 0.062 x 0.075 (1.57 x 1.91)	0.038 x 0.045 (0.96 x 1.14) 0.062 x 0.075 (1.57 x 1.91)
Shelf Life (bulk material) from Date of Manufacture	Chomerics	months	6 at 5±2°C	6 at -10±2°C	6 at -10±2°C	6 at -10±2°C

*Compression set is expressed as a percentage of deflection per ASTM D395 Method B., at 25% deflection. To determine percent recovery, subtract 1/4 of stated compression set value from 100%. For example, in the case of 30% compression set, recovery is 92.5%.

Note: NR - Not Recommended, NA - Not Applicable See Chomerics for product specifications if needed

The user, through its own analysis and testing, is solely responsible for making the final selection of the system and components and assuring that all performance, endurance, maintenance, safety and warning requirements of the application are met. The user must analyze all aspects of the application, follow applicable industry standards, and follow the information concerning the product in the current product catalog and in any other materials provided from Parker or its subsidiaries or authorized distributors.



Cure System Legend	
	
Moisture Cure	Thermal Cure

Table 8-3 continued

CHOFORM - Conductive Form-In-Place Gaskets						
Typical Properties	Test Procedure	Units	CHOFORM® 5575	CHOFORM® 5526	CHOFORM® 5528	CHOFORM® 5538
Features	--	--	High corrosion resistance on aluminum	High conductivity, excellent grounding and shielding	Soft, low closure-force	Corrosion resistant, small bead
Conductive Filler	--	--	Ag/Al	Ag	Ag/Cu	Ni/C
Resin System	--	--	Silicone	Silicone	Silicone	Silicone
Number of Components	--	--	1	1	1	1
Cure System	--	--	Moisture	Moisture	Moisture	Moisture
Hardness	ASTM D 2240	Shore A	80	38	40	65
Cure Schedule Tack Free Time Handling Time Full Cure			18 mins @ 22° C & 50% RH 4 hours @ 22° C & 50% RH 24 hours @ 22° C & 50% RH	18 mins @ 22o C & 50% RH 4 hours @ 22o C & 50% RH 24 hours @ 22o C & 50% RH	18 mins @ 22o C & 50% RH 4 hours @ 22o C & 50% RH 24 hours @ 22o C & 50% RH	18 mins @ 22o C & 50% RH 4 hours @ 22o C & 50% RH 24 hours @ 22o C & 50% RH
Tensile Strength	ASTM D 412	psi	80	38	125	325
Elongation	ASTM D 412	%	50	75	100	65
Specific Gravity	ASTM D 395	--	1.9	3.6	3.4	2.2
Volume Resistivity	Chomerics MAT-1002	Ω-cm	0.010	0.003	0.005	0.050
Galvanic Corrosion Resistance Against Alum	Chomerics TM-100	Weight Loss mg	Not Tested	NR	NR	10
*Compression Set 22 hrs @ 70° C	ASTM D 395 Method B	%	40	45	45	45
Maximum Use Temp	--	°C (°F)	125 (257)	85 (185)	85 (185)	85 (185)
Flammability Rating	UL 94	--	V-0	V-0	V-0	V-0
Shielding Effectiveness (avg 200 MHz - 12 GHz)	Modified IEEE-299	dB	80	>100	>70	>60
Adhesion Trivalent Chromate Coating on Alum	Chomerics WI 038	N/cm	10	9	3.8	9
Force Deflection @ 30% Compression 0.034" x 0.040" sized bead (0.86 mm x 1.02 mm) English Metric	ASTM D 375 Mod ASTM D 375 Mod	lb-f/in N/cm	25	15.0 26.3	20 35.0	28.5 49.8
Bead Size Smallest Recommended Largest Recommended (single pass)	Height by Width Height by Width	inches (mm) inches (mm)	0.034 x 0.040 (0.86 x 1.07) 0.050 x 0.065 (1.27 x 1.65)	0.018 x 0.022 (0.46 x 0.56) 0.042 x 0.049 (1.07 x 1.24)	0.018 x 0.022 (0.46 x 0.56) 0.039 x 0.052 (1.00x1.32)	0.015 x 0.020 (0.38 x 0.51) 0.030 x 0.034 (0.76 x 0.86)
Shelf Life (bulk material) from Date of Manufacture	Chomerics	months	5	6 at 22±5° C	6 at -21±5° C	5 at 22±5° C

*Compression set is expressed as a percentage of deflection per ASTM D395 Method B., at 25% deflection. To determine percent recovery, subtract 1/4 of stated compression set value from 100%. For example, in the case of 30% compression set, recovery is 92.5%.

Note: NR - Not Recommended, NA - Not Applicable See Chomerics for product specifications if needed

Table 8-4

ParPhorm - Non-Conductive Form-In-Place Gaskets						
Typical Properties	Test Procedure	Units	ParPhorm® 1800	ParPhorm® S1945-25	ParPhorm® L1938-45	
Hardness	ASTM D2240	Shore A	20	25	45	
Tensile Strength	ASTM DD412	(min.) (psi)	150	277	616	
Elongation	ASTM D412	%	650	316	271	
Specific Gravity	ASTM D297	--	1.4	0.78	1.24	
Compression Set 70 hrs., 25% deflection @ 212° F (100° C) 70 hrs. @ 158° F (70° C) 2000 hrs. @ Room Temp 2000 hrs. @ 158° F (70° C)	ASTM D395 Method B	%	35 -- -- --	42 21 -- --	29 14 29 --	
Cure System	--	--	Moisture	Thermal	Thermal	
Cure Schedule Tack Free Time Handling Time Full Cure	--	--	18 mins @ 22° C & 50% RH 4 hours @ 22° C & 50% RH 24 hours @ 22° C & 50% RH	30 mins @ 140° C 30 mins @ 140° C 30 mins @ 140° C	30 mins @ 140° C 30 mins @ 140° C 30 mins @ 140° C	
Resin System	--	--	Silicone	Silicone	Fluorosilicone	
Bead Size Smallest Recommended Largest Recommended (single pass)	Height by Width Height by Width	inches (mm) inches (mm)	0.018 x 0.022 (0.46 x 0.56) 0.050 x 0.063 (1.27 x 1.60)	0.018 x 0.022 (0.46 x 0.56) 0.050 x 0.063 (1.27 x 1.60)	0.018 x 0.022 (0.46 x 0.56) 0.050 x 0.063 (1.27 x 1.60)	
Shelf Life (bulk material) from Date of Manufacture	Chomerics	months	4 at 21±5° C	6 at 21±5° C	6 at -10±5° C	

FORM-IN-PLACE

Important Considerations for Optimizing Quality & Production Efficiency

A shielded housing is an assembly whose quality and performance are functions of all the parts and processes used to produce it.

Whenever possible, Parker Chomerics interfaces on behalf of OEM customers with suppliers of die-cast metal and injection-molded plastic housings in advance of tool design and production. Detailed guidance is provided on part and tool design, part reproducibility, locating features, tolerances and surface conditions — issues that are key to the quality and economics of robotic gasket dispensing.

Parker Chomerics can act as lead vendor, managing the entire housing supply chain to ensure the best results for OEM customers.

The following section provides answers to commonly asked questions, and highlights critical design issues that affect production efficiency and cost.

Housing Material Considerations Plastic Substrate Selection

If the housing is an injection-molded thermoplastic, the gasket cure temperature is an important parameter.

Different thermoplastics soften or stress-relieve at different temperatures.

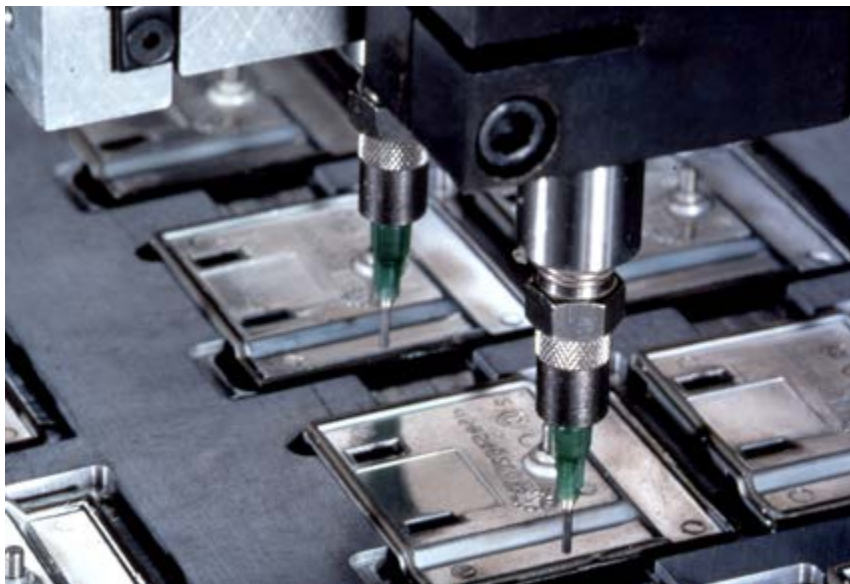

Surface Preparation

Metal or plastic surfaces to be gasketed with CHOFORM materials should exhibit electrical surface resistance of <0.01 ohm. They should be clean and free of dirt, oils and organic solvents.

Metallic housings must be treated to remove release agents and machining oils. Aluminum parts should be chromate conversion coated (alodine or irridite) per MIL-DTL-5541 Class 3. Magnesium parts should be protected with Dow 20 modified chrome pickle or equivalent.

Plastic housings require metallizing, which may be accomplished by plating, aluminum vacuum deposition or conductive paint. For plating, nickel-copper is preferred. It adheres well, provides 80+ dB of shielding effectiveness, and remains electrically stable over time. If vacuum deposition is chosen, a nitrogen purge is mandatory to ensure good adhesion.

Differences in commercially available conductive paints necessitates testing them with the selected CHOFORM gasketing material. Parker Chomerics CHO-SHIELD® 2056, 610, 2040 and 2044 conductive coatings have been formulated to adhere well and be galvanically compatible with CHOFORM materials. The superior performance and batch-to-batch uniformity of these paints have been extensively demonstrated in these applications. Their high abrasion resistance provides protection during product assembly and use.

Protective Packaging To avoid cosmetic injuries such as surface scratches, parts should be shipped in compartmentalized plastic or corrugated paper trays. If requested, Parker Chomerics will arrange for specialized packaging to be delivered to the housing manufacturer.

**Gasket Design Considerations
Start/Stop Bead Profiles**

Designers should anticipate slight differences in gasket bead cross section in the start/stop zones compared with the very uniform profile produced during steady-state dispensing of straight runs. Figures 8-1 to 8-4 illustrate the nature of these intrinsic differences and the adjusted tolerances in the initiation and termination zones, which are defined as 0.100 inch (2.54 mm) long.

Engineering drawings should reflect a less well-defined gasket profile in start/stop zones, to facilitate Quality Control inspections of incoming parts. Suggested drawing references appear in Figures 8-2 and 8-3.

In programming the dispense path, sufficient flexibility exists to minimize the number of start/stop events and to locate such events where the gasket profile is not critical. Part drawings should identify any areas in which the increased cross section tolerances associated with start/stop zones would create a problem.

Figure 8-1 Characteristic appearance of start/stop events

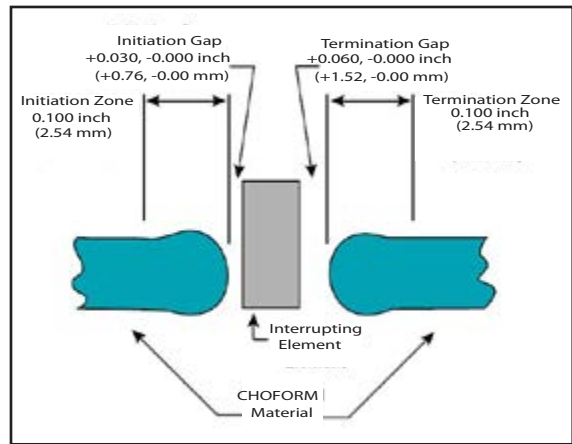
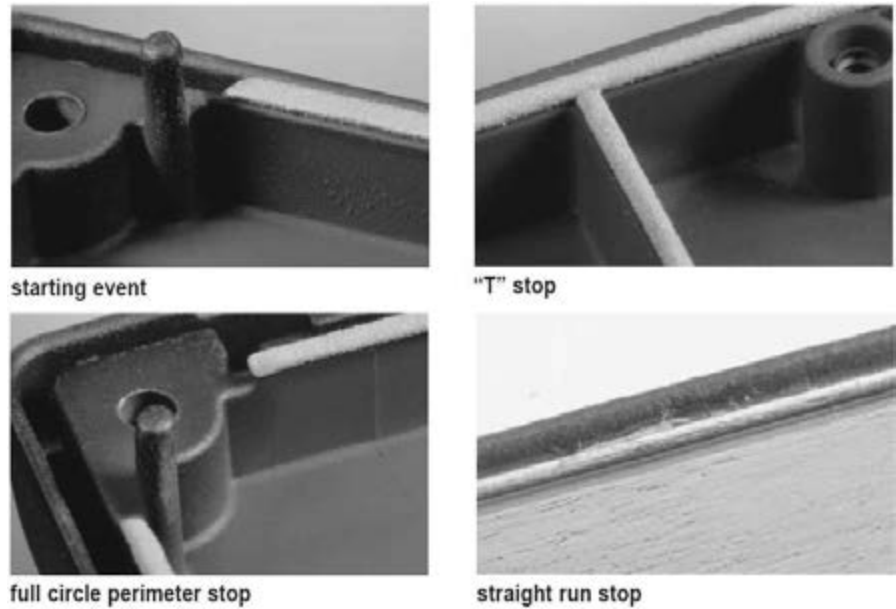

Figure 8-2 - Top View Location tolerances for bead initiation & termination zones (cross-sectional view)

Figure 8-3 - Side View Gasket height tolerances

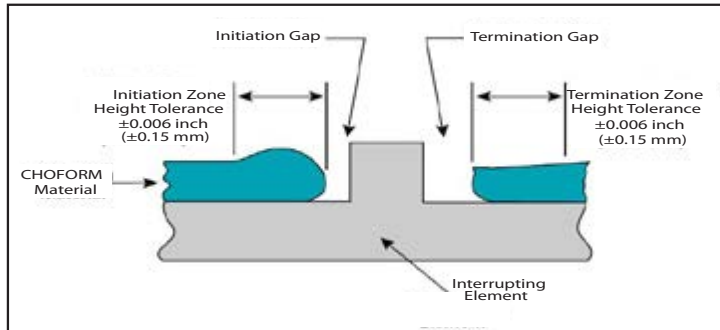
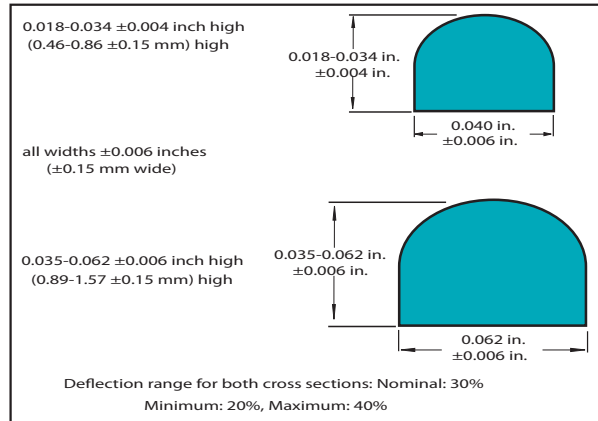

Figure 8-4 Suggested cross sections with height-to-width ratio of 0.85



FORM-IN-PLACE

Critical Housing Design Issues

CHOFORM FIP gasket technology

accommodates a reasonable degree of variability in housing part dimensions. However, setup and dispensing speed are directly impacted by part uniformity. In addition, the housing design can pose obstacles to efficient gasket dispensing.

The most common avoidable problem is warped or non-uniform housings. If housings are not sufficiently flat and dimensionally uniform, they must be restrained by special alignment and hold-down fixtures, which can add substantial setup time.

For best results and production economics, designs should reflect the following considerations:

Positive Locating Features Speed Production

Parts should be easily fixtured for fast, accurate dispensing

Reproducible positioning of the parts beneath the dispensing head is fundamental to this automated technology. Maximum production speed can be achieved when through-holes are available to pin-position parts on the pallets that transport them to the dispensing head. If through-holes are not available, two sides can be pushed against pallet rails for positioning. This requires hold-down clamps that must be positioned without interfering with the dispensing needle.

Avoid features that complicate design of a locating system

Parting lines in dies or molds can interfere with the establishment of a locating edge. Mold gates, runners or flash can interfere with positioning pins or fixtures.

Part Reproducibility is Critical

Flanges, rails or ribs to be gasketed should have part-to-part location reproducibility (X and Y dimensions) within 0.008 inch (0.20 mm)

Once the dispense path is programmed, all surfaces to be gasketed must be located where the program assumes them to be. Variation greater than 0.008 inch (0.203 mm) will result in gasket beads dispensed partly on and partly off the intended surfaces.



Wall heights must be reproducible in the Z axis within 0.012 inch (0.30 mm)

Manufacturing processes for die-cast metal and injection molded plastic housings generally can produce parts with intrinsically reproducible, uniform dimensions in the Z axis.

Several factors determine the gasket bead profile — air pressure in the needle, material viscosity, needle diameter, feed rate and needle height (Z) above the part. Accurate Z-axis programming is central to dispensing an optimum gasket profile. Full 3-axis programmability of the CHOFORM dispensing heads is an important advantage in accommodating the necessary tolerances on the Z-axis position of the surface to be gasketed.

Selection of a housing supplier able to meet the reproducibility requirements for the Z-axis can make a real difference in the quality, speed and economics of gasket dispensing.

Production housing functions as master

The CHOFORM gasket dispensing head is programmed in 3 axes by plotting the path which the needle will follow, using a representative production housing as the master. Programming can account for unintended but consistent deviations in elevation, such as:

- non-parallelism
- non-flatness
- warping

As a whole, these elevation deviations must be consistent from part to part within 0.012 inch (0.30 mm). If not, special mechanical restraint fixturing

will be required to ensure accurate gasket dispensing. Fixturing schemes usually entail delay and expense and may also impact production speed.

Parallelism to a defined plane

Using one or more specific part features for locating purposes, housings are mounted on a machined pallet and conveyed to the dispensing head. The pallet surface defines the “datum plane” for Z-axis motion of the dispensing needle.

CHOFORM gaskets can be dispensed onto a part surface of known slope with respect to the datum plane (recommended up to 60°). Application onto a flat surface (i.e., 0° slope) can actually be more difficult than application to a sloped surface if part thickness is not consistent. Variation in overall part thickness will cause the surface to be gasketed to be non-parallel with the datum plane. Z-axis adjustments to the needle’s path are programmed using the representative “master” part. However, these variations must be consistent in both location and degree, and within the 0.012 inch (0.30 mm) aggregate allowable tolerance to avoid the need for special fixturing. (Figures 8-6a and 8-6b.)

Flatness of the surface to be gasketed

Unevenness in flanges, rails or ribs to be gasketed can be programmed into the Z-axis motion of the dispensing head. Again, this Z-axis variation must be consistent from part-to-part within the 0.012 inch (0.30 mm) aggregate tolerance to avoid the need for fixturing. (Figures 8-7a and 8-7b.)

Warping of the housing

As with parallelism and flatness of the surface to be gasketed, warping of the entire part can contribute to a Z-axis variation that exceeds the 0.012 inch (0.30 mm) tolerance for reproducibility. The trend toward smaller electronic packages with thin housing walls makes this a common occurrence. If surfaces for part hold-down are available, this condition can be accommodated by fixturing. However, setup and production time will be affected.

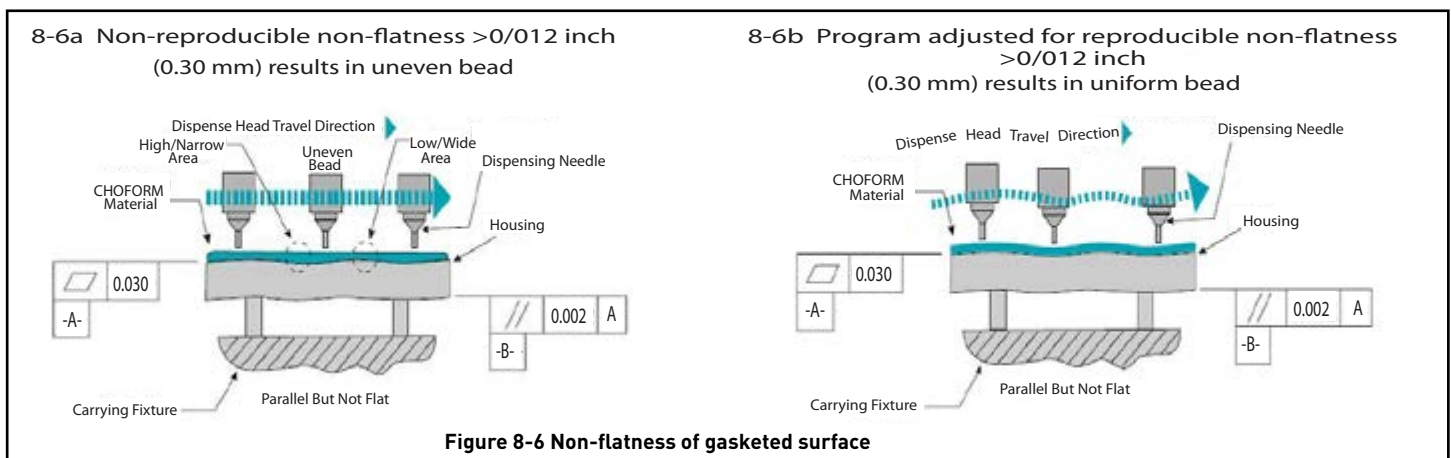
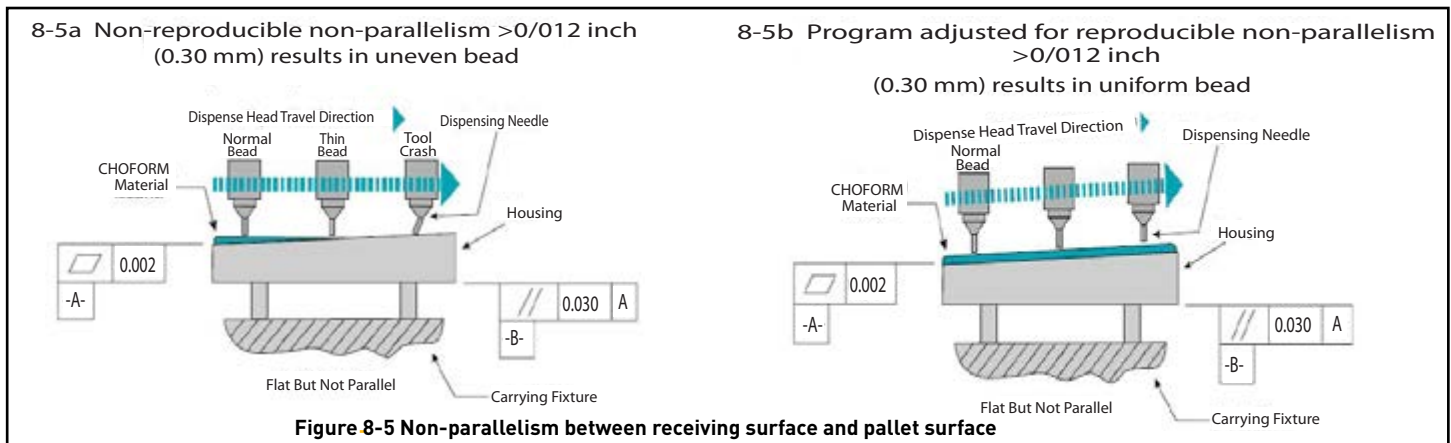

Keep the need for part restraint to a minimum

When the part-to-part reproducibility of flatness requirement cannot be met, mechanical restraints are fabricated which temporarily flattens the part for proper dispensing of the gasket. Whenever possible, Chomerics exploits design features such as through-holes and edge rails for clamping. If such features do not exist, more complicated fixturing schemes must be designed to induce the necessary flatness, with a corresponding time and cost penalty.

Avoid Z-axis Obstructions

Sidewall proximity to the dispensing needle

Often, a form-in-place EMI gasket is applied along a "ledge" adjacent to a higher sidewall. The dimensional tolerances on ledge and sidewall locations are particularly critical, to avoid sidewall interference with the moving needle a minimum of 0.010" clearance is required (Figure 8-7).

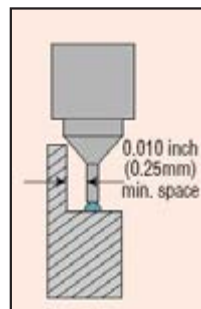

Figure 8-7 Sidewall interference with dispensing needle

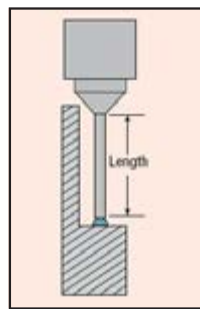

Figure 8-8 High sidewalls may necessitate longer needles, reducing speed

High sidewalls slow dispensing

High sidewalls adjacent to the gasket dispensing path may require an elongated needle to provide the necessary clearance for the dispensing head (Figure 8-8). The longer needle adds friction to material flow, reducing dispensing speed by as much as 75%.

This can frequently be avoided by positioning high sidewalls on the mating part or by reducing their height to less than dispensed width of the gasket.

Through-hole interference

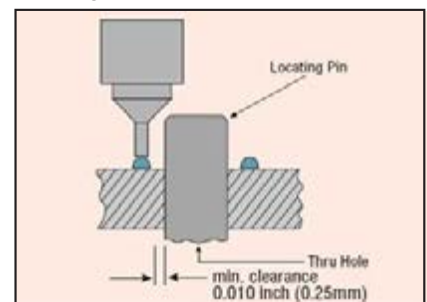

Figure 8-9 Dispensing path obstructed

In cases where the housing incorporates through-holes used to position the part on its pallet, the holes must not intersect the dispensing path. Clearance of less than 0.010 inch (0.25 mm) could result in screw heads or locating pins obstructing the dispensing needle (Figure 8-9).

CHO-MUTE™ Microwave Absorber Materials

CHO-MUTE™ is Parker Chomerics trade mark for its broad band EMI absorber materials. These products absorb energy moderately over a broad frequency range. Broad band absorbers cover the widest range of applications. There are frequency specific absorbers that will absorb more dB, in a narrow frequency band, however Parker Chomerics does not currently offer narrow band frequency band absorbers at this time.

Microwave absorbers are made of two main components, a filler material that does the absorption, and a material matrix to hold the filler. The filler controls both how and what frequencies the material will absorb, while the matrix provides other benefits such as flexibility, weather resistance, and temperature resistance.

Absorption materials have a combination of electrical permittivity and magnetic permeability materials. Microwave absorbers are filled with dielectric ferromagnetic materials. As a microwave strikes these materials, the wave becomes attenuated and lose energy due to being converted to heat. The amount of energy lost depends on the frequency of the wave and the dielectric constant of the material. The permittivity is a measure of the material's effect on the electric field in the electromagnetic wave and the permeability is a measure of the material's effect on the magnetic component of the wave. The permittivity arises from the dielectric polarization of the material. The permeability is a measure of the material's effect on the magnetic field. Both components contribute to wavelength compression inside the material. Absorptive materials can affect permittivity and permeability in different proportions over different frequency ranges.

CHO-MUTE has an elastomeric binder and are typically sold as die-cut parts with a pressure sensitive adhesive (PSA) backing. Parts can

be die-cut completely or kiss cut for easier removal from the PSA liner paper. Cut parts can be put into "reel form" to accommodate automated reel-to-reel manufacturing process.

CHO-MUTE is known as a "Magnetic" frequency absorbing material. By controlling magnetic and dielectric loading as well as thickness the materials absorptive properties change. Magnetic frequency absorbers operate via phase cancellation. The incoming wave incident upon the absorbing material is partially reflected and partially transmitted. The transmitted portion undergoes multiple internal reflections to give rise to a series of secondary reflective waves. Generally, based on the principle of phase cancellation, the lower the frequency to be attenuated, the thicker the material must be.

Designers of RF absorbing and microwave absorbing (RF absorbers, microwave absorbers) materials must consider electrical, physical, and application parameters when determining which type of absorber to specify. Engineers must account for desired effect (reflection loss, insertion loss, cavity resonance reduction, or surface wave attenuation), frequency band, coverage area and environmental exposure. Absorbers have become an important element in some systems to not only reduce component and circuit radiation but also reduce interference between circuit components. CHO-MUTE is typically applied in two ways, either inside a metal cavity (Cavity Resonance) on the metal surface, or simply placed over the expected source/circuit (Near Field).

Cavity Resonance

Cavity resonance is where signals are trapped/contained within a metal enclosure or compartment. The metal enclosure can be as small as a metal can over a single Integrated Circuit (IC) chip, an area

of a printed circuit board or even an enclosure (case) cover. Signal radiation in an enclosed space is in the form of standing waves and not in free space. In standing waves, the E field and H field are 90° out of phase with each other. Using a material with high permittivity/permeability that will attract the energy and absorb it is the most effective way to reduce the signal strength. These highly permeable cavity resonance absorbers will have high magnetic loss. Material thickness is not usually as important in these applications.

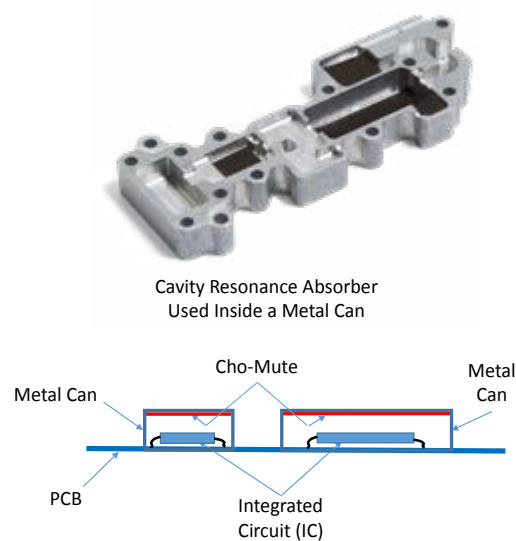

Figure 9-1

When an absorber is inserted into the cavity, the high permittivity/permeability of the absorber causes the energy to move into the absorber. In addition, induced electrical currents flow on the inside surface of the metal enclosure. The high permittivity/permeability material will impede the flow of electrons (current) and absorb the energy.

Near Field Absorbers

Near field absorbers are placed near or directly upon a radiating element. The element can be a single Integrated Circuit (IC) chip

and/or an area of a printed circuit board. Since the energy in the near field is predominantly magnetic the material must have high magnetic permeability and high magnetic loss. In order to avoid shorting out the circuit elements, they must have very high resistance (low conductivity).

All circuits will contain components and circuit traces that will resonate and radiate signals at particular frequency. Although the close proximity magnetic fields energy dies off very quickly with distance they can still interfere with any circuit in close proximity.

Near field experimentation is done using two loop antennas and comparing the magnetic field energy that can be transmitted between them. Coupling is compared after placing an absorber material in between or in near contact with the loop(s). See the Near Field Test Method description below. Selection of an absorber material should take this test method into account if data exists.

In general, using Finite Element Method (FEM) software solutions for selecting a microwave absorber for these applications is possible. The

geometry of these conditions can easily be measured. However, the signals generated and frequency spectrum related to typical Integrated Circuits and associated PCB circuitry is very complex.

Typically, microwave absorbers are selected based on "trial and success".

Test Methods

NRL Arch Test Method

The Naval Research Laboratory (NRL) Arch is usable over a wide frequency range for measuring reflectivity of microwave absorber materials. A signal is transmitted toward a metal plate on a center table and "reflected" to the receive antenna on the opposite side of the arch with a Network Analyzer. The absorber material is then placed on the metal plate which results in a reduction in signal strength at the

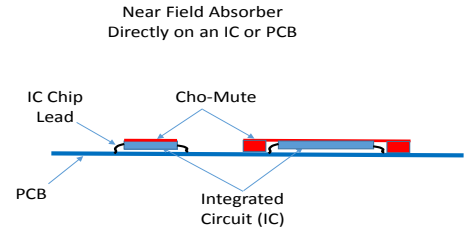

Figure 9-2

receive antenna.

Repositioning the antennas on the arch will allow measurements of performance at off normal angles of incidence. The typical size of the material under test is either 12 or 24 inches square. The standard frequency range is 2-18 GHz and an antenna to plate distance of 30-36".

There are limitations in the ability to separate the signal from the material under test from the direct antenna due to the size of the arch and test sample. Parker Chomerics utilizes a smaller arch and sample size for frequencies higher than 18GHz.



Free Space Test Method

Using a Free Space test method will provide accurate measurements of electromagnetic parameters such as electric permittivity $\epsilon^* = \epsilon' - j\epsilon''$ and magnetic permeability $\mu^* = \mu' - j\mu''$ to evaluate the performance of microwave absorbers.

In order to obtain both real and imaginary permittivity and perme-

ability (ϵ, μ), four measurements are required to be taken which are usually the magnitude and phase of S11 (reflection) and S21 (transmission) through the sample. The terms S11 and S21 are Measurement Methods in typical Network analyzers.

This test is accomplished by using beam focused antennas and transmitting a signal between them.

These antennas have a specific beam size at a specific distance. However, the antennas can typically be used over a frequency band. For example, beam focused X band antennas are usable over the entire 8.2 to 12.4GHz if designed properly. Different antennas are required for different frequency bands.

The test sample is positioned at the center point between the antennas and is typically 12 inches square.



Waveguide Test Method

Using a Free Space test method will provide accurate measurements of electromagnetic parameters such as electric permittivity and permeability to evaluate the performance of microwave absorbers. However, sample sizes are large compared to the samples needed for the waveguide test method.

A full 2 port calibration is needed for accurate phase and reflection measurements. The test sample is then inserted into the waveguide.

Critical in achieving good test results is knowing the exact dimensions of the tests sample inserted into the waveguide. This is even more important as the frequency increases and the wavelength decreases.

Parker Chomerics utilizes three primary waveguide section for this test, S Band (2.6 – 3.95GHz) with a primary frequency of 3GHz, X Band (8.2 – 12.4GHz) with a primary frequency of 10GHz and Ku Band (12.4 – 18GHz) with a Primary frequency of 10GHz. Below is a picture of the X Band Waveguide.

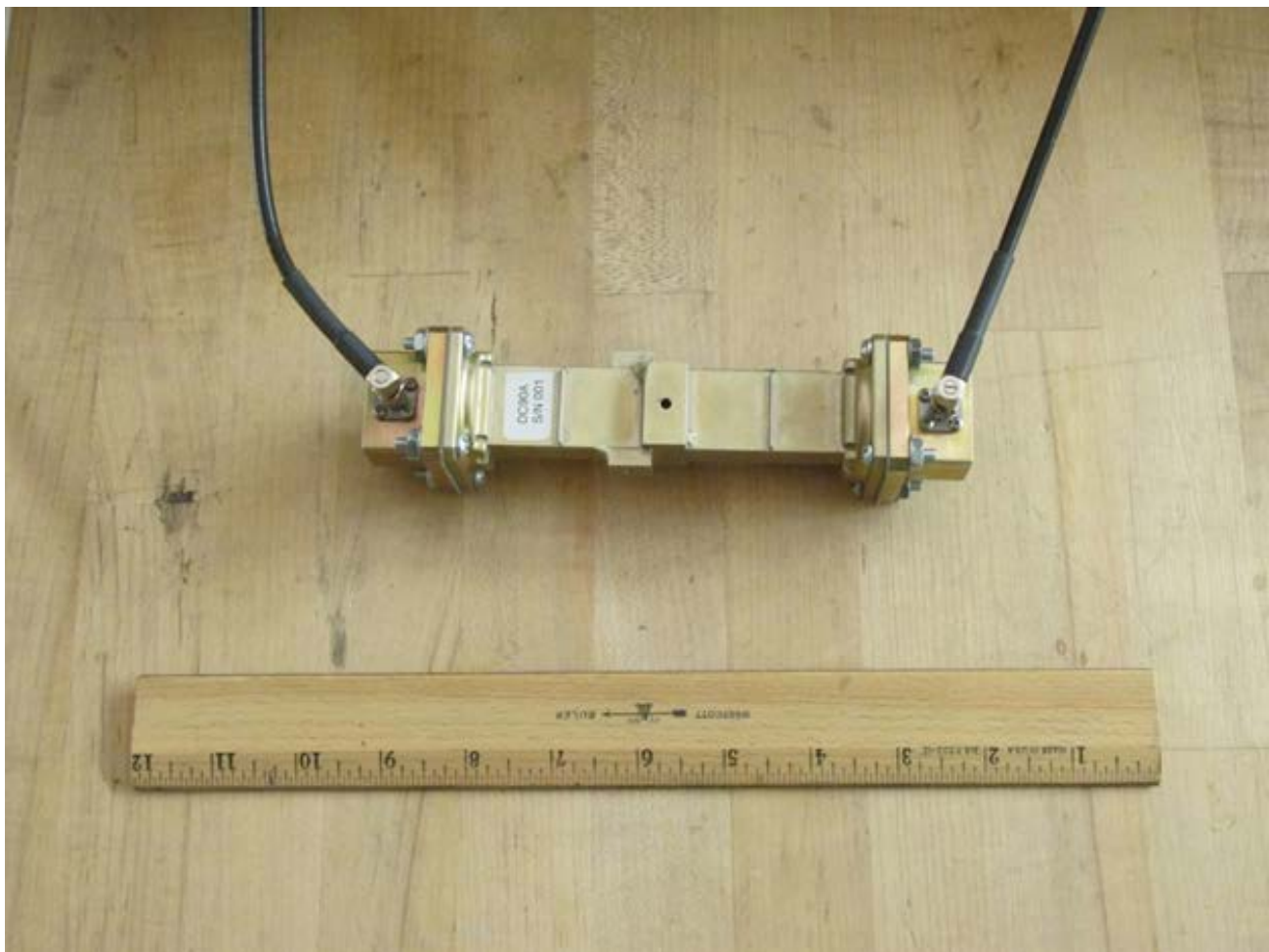

Insertion Loss Test Method

Insertion loss is a measure of how much microwave energy is lost as the wave travels through the material. This is typically performed using the Free Space test setup described above.

This test is accomplished by using beam focused antennas and transmitting a signal between them – or – by pointing the antenna's at each other. Here again, the test sample is positioned at the center point between the antennas and is typically 12 inches square. A Network Analyzer compares the difference between the signal level with and without the test sample in place.

Many sizes of this test setup exist to test smaller or larger test samples. Care must be taken to ensure that the material under test is being measured and not reflections developed in the test area or signals passing around the actual test sample due to antenna beam width.

Insertion Loss Test Method

Near field Test Method is similar to the Free Space and Insertion loss Test Methods. However, in this case, the antennas are replaced with Micro Loop antennas and the propagation of energy off the antennas is a magnetic field.

Parker Chomerics Near Field Test Setup (design image and actual photo shown below) uses a 4 inch square samples size. A Network Analyzer compares the difference between the signal level with and without the test sample in place.

Small changes in antenna distance can be controlled by the Micrometers on both sides and both horizontal and vertical antenna polarizations can be measured.

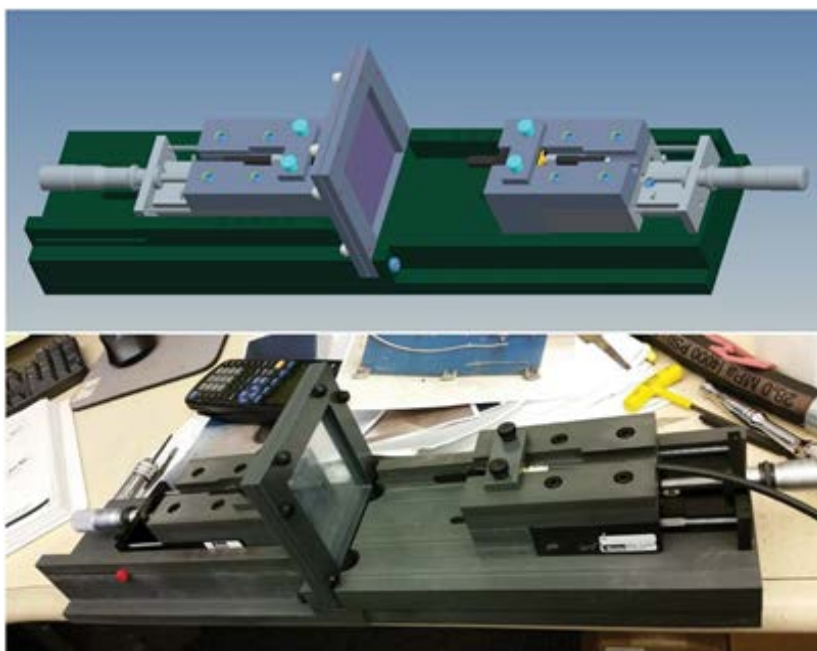

Two different types of tests are common with this fixture. First, the antennas are placed on opposing sides of the test sample and the measurement passes a signal through the material. Second, the antennas are both placed on the same side of the test sample and the measurement couples the energy onto the material as illustrated below.

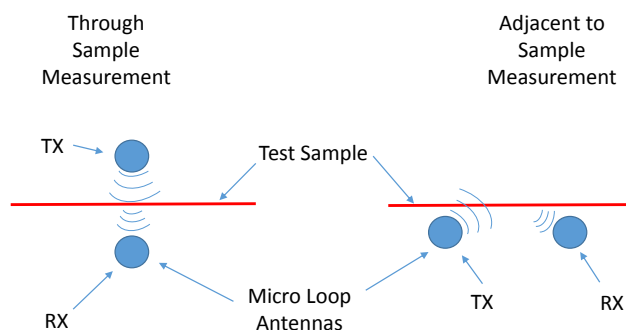
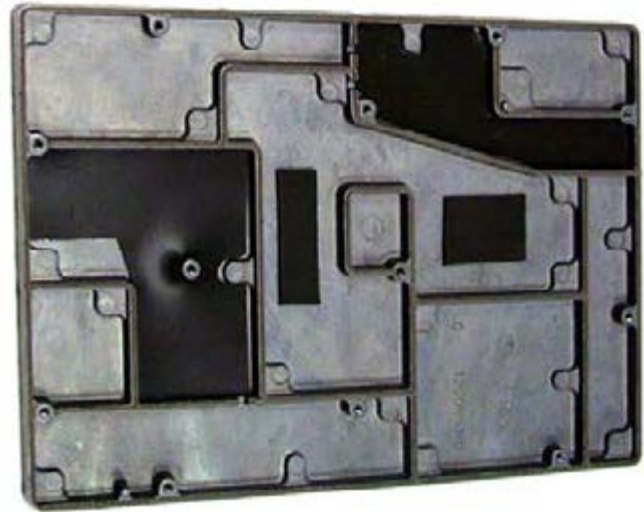
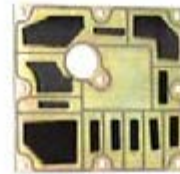

Figure 9-3

CHO-MUTE™ 9005 and 9025

Microwave Absorber Materials
UL 94 V-0 Flammability Rated



Customer Value Proposition:

CHO-MUTE 9005 and 9025 elastomer based absorber materials are designed to offer a user friendly approach to the reduction of unwanted electromagnetic radiation from electronic equipment as well as minimize cavity to cavity cross coupling, and microwave cavity resonances. Comprised of a silicone elastomer matrix with ferrous filler material, these materials provide RF absorption performance over a broadband frequency range from 500 MHz to 18 GHz. The materials are offered as sheet stock of various thicknesses with or without pressure sensitive adhesive. They are flexible, and can be easily die-cut for use in empirical testing of absorption solutions. Since both materials have been tested and certified to the UL 94 V-0 flammability standard, they may be used in close quarters with electronic circuitry to reduce unwanted electromagnetic radiation by absorption of signals and reduction of reflections from metallic surfaces. A wide variety of fabricating techniques are available for custom part manufacturing.

Product Features:

- Microwave absorption material covering a wide range of frequencies
- Up to 20 dB RF absorption
- Available in six standard thicknesses
- Flexible
- RoHS Compliant
- Global product availability
- UL 94V-0 certified

Typical Applications:

- Hand held electronics
- Wireless voice or data telecommunication
- Military electronics
- GPS
- Ruggedized computers
- Night vision equipment
- Telecommunication infrastructure equipment

Table 9-1

Typical Properties	Test Method	Units	Value
Composition			
Ferrous	--	--	--
Electrical			
Surface Resistance Initial	CEPS-0002	Ω /square	>1M
Bulk Volume Resistivity Initial	CEPS-0002	$\Omega \cdot \text{cm}$	>1M
Permeability	ASTM D2520	--	1.76
Magnetic Loss Tangent	ASTM D2520	--	0.602
Permittivity	ASTM D2520	--	13.8
Dielectric Loss Tangent	ASTM D2520	--	0.15
Mechanical			
Operating Temperature Range	--	--	-50°C to 160°C
Tensile Strength	ASTM D412	PSI (MPa)	500 (3.44)
Elongation	ASTM D412	(% min)	200
Hardness	ASTM D2240	Shore A	55
Tear Strength	ASTM D624	Lb/in (N/m)	60 (10.5k)
Thermal			
Thermal Conductivity	ASTM D5470	W/m-K	9005 = 0.56 9025 = 0.87
Physical			
Specific Gravity	--	--	3.4

Ordering Information

Part Number: 46-TA-1020-90XX.

Custom part numbers available upon request.



CHO-MUTE	Thickness, inch (mm)	Adhesive (PSA)	Sheet Size	
	1. 0.020 (0.51)	0. No Adhesive 1. Adhesive Backing	10" X 20" (25.4cm X 50.8cm)	9005
	2. 0.032 (0.81)			9025
	3. 0.062 (1.57)			
	4. 0.093 (2.36)			
	5. 0.125 (3.18)			
	7. 0.010 (0.25)			

Graph 9-1

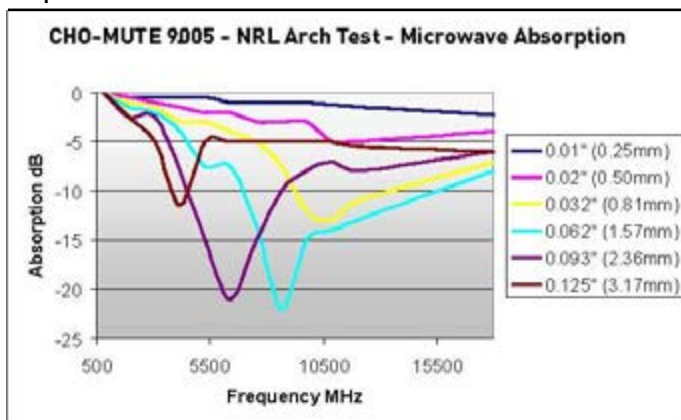

Graph 9-2

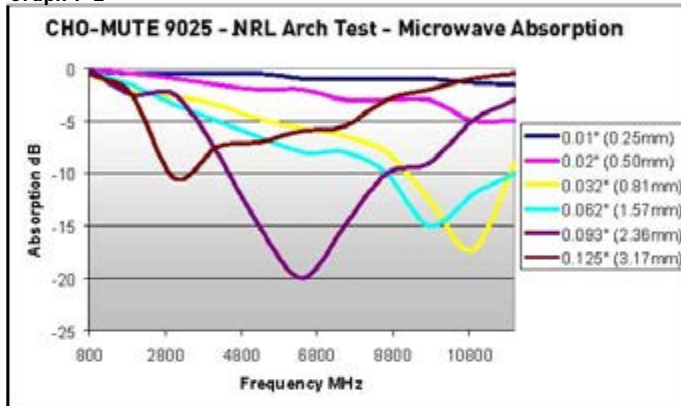

Graph 9-3

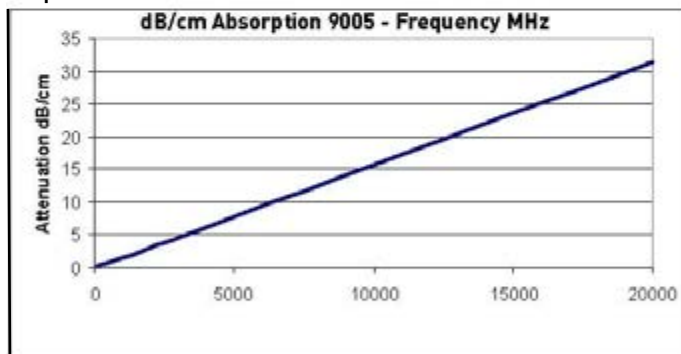

Graph 9-4

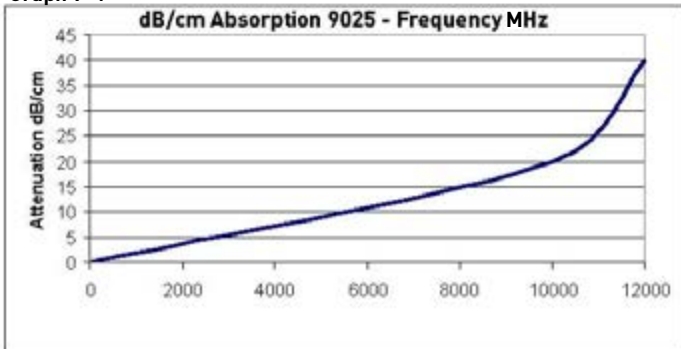

ABSORBERS



Integrated Solutions

From Design Concept Through Supply Chain Management

Integrated Solutions

From Design Concept Through Supply Chain Management

CONTENTS

EMI Shielded Thermoplastic Housing Supply Service Summary.....	132
Injection Molding.....	133
EMI Shielding & Non-Conductive Thermoplastics.....	134
EMI Shielding Coating/Plating.....	135
Optical Assemblies.....	136
Secondary Assembly, EMI Gasketing/Thermal Management.....	137
EMI Compliance & Safety Testing.....	138
Supply Chain Management.....	139
Dispensed EMI & Environmental Gaskets On Plastic Or Metal Housings.....	140
Conductive Elastomer Overmolded Solutions on Plastic & Metal.....	141

EMI Shielded Thermoplastic Housing Supply Service

SUPPLY CHAIN MANAGEMENT

Parker Chomerics can supply a complete single source solution to your EMI shielding needs in plastic housings regardless of technology. We can

- Reduce your total cost of ownership up to 60% by eliminating secondary machining or providing parts consolidation
- Reduce part weight by up to 75% with thinner walls using a lower material density when compared to aluminum die castings for weight sensitive applications
- Reduce your time to market by providing a single point for part and tooling design including all tool manufacture
- Eliminate cost with multi-supplier part supply logistics and quality management

Our engineering staff can take the project from concept through production. Your project will be assigned a program manager. The engineer will manage

- Part design assistance
- Material selection
- Tooling design & manufacture
- Production start-up with part approval

PLASTICS INJECTION MOLDING

Parker Chomerics Injection Plastics Business Unit has over 45 injection molding presses ranging from 22 to 1,000 tons, enabling the molding of virtually any part. We can use Parker Chomerics EMI Shielding PREMIER® thermoplastic or non-conductive thermoplastics with secondary EMI coatings.

If the design calls for secondary conductive coatings (paints, vacuum metallization, selective plating, or thermal spraying) our in-house or authorized suppliers can provide the solution.

If secondary assembly is needed, we have competency in

- Heat staking
- Sonic welding
- Mechanical assembly

We can apply cosmetic coatings, using manual or robotic spray. Labeling and graphics can be added using pad printing or silk screening.

OPTICAL DISPLAYS

If the device requires a display filter, the Optical Products Business Unit can design and supply using the latest technology. The filters can provide EMI shielding and or improve viewability in

any environment. Materials choices can deliver resistance to harsh environments and severe mechanical stress. The display filter may be incorporated into the housing or bezel, ready for assembly.

EMI SHIELDING

EMI shielding gaskets can be added as an integral part of the housing using our in house supply of all gasket technologies. If thermal management components are needed we can supply heat sinks with thermal interface materials integrated into the part.

EMC TESTING

Our Test Services Business Unit can perform EMC and Safety compliance testing when the device is ready to go to market. We will verify performance and help get your product on the market.

Parker Chomerics wants to be your single source of supply for an integrated solution for your EMI shielded housing. Contact us at 781-935-4850 to learn more about our service.

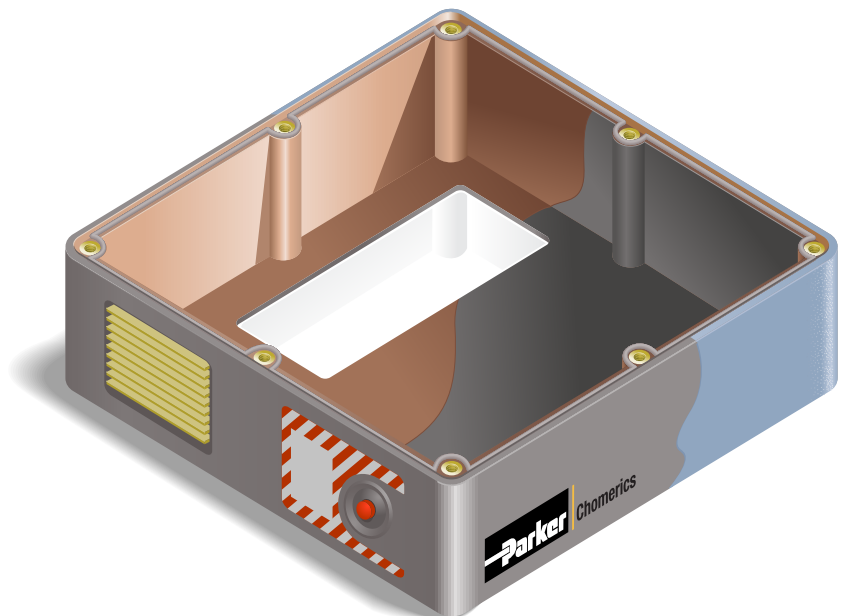

Injection Molding

Parker Chomerics Plastics Business Unit has over 60 years experience in injection molding precision engineered thermoplastic parts at our Fairport NY facility. Our facility is ISO/TS 16949 certified and was recognized by Industry Week as a Best Plant winner. We regularly mold over 300 different polymer systems to exacting tolerances to supply the Telecom, Information Technology, Consumer Electronics, Military Electronics, Medical Equipment and Transportation markets. With both EMI shielding and non-conductive thermoplastic polymers to choose from, we can meet your performance needs.

Our engineering staff can take the project from conceptual model through production. When the program is initiated a project engineer will be assigned. We can assist in part design working within your parameters. Part geometry will be optimized for the highest performance and lowest possible material, processing and tooling costs. Using FEA we will ensure part performance to your specifications.

Upon part design completion a mold flow analysis allows us to create a 3-D of flow patterns for the injection molding process. We can graphically

and statistically visualize flow rates, pressures, and temperature values throughout the entire part. This tool helps us adjust the molding process by locating entry gates and compensating for variable pressures or cooling rates to avoid part warpage or uneven shrink rates. It will also alert us if part design has to be modified to assure the part's strength and integrity.

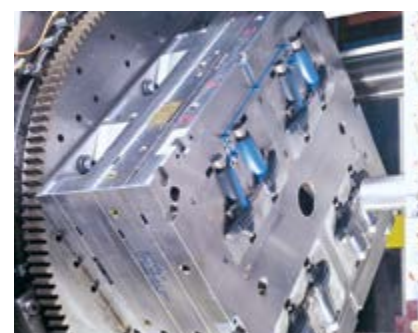

We will source the tooling and build the optimal mold. Before entering production the tool is inspected to a tolerance within one ten thousandths of an inch. First articles are fully inspected with full PPAP (Production Part Approval Process) reporting back to the customer. Our in-house tooling department will keep the tool in optimum condition throughout its useful life.

With over 45 injection molding presses ranging from 22 to 1,000 tons we can injection mold virtually any part. Our advanced closed-loop materials delivery system cleans, conditions and delivers precise blends of raw materials to each injection molding machine. An efficient micro filter system traps dust and fine particles and measures the proper portion of re-grind material, delivering high performance thermoplastics 100% of the time.

Once the part enters production a Lean Manufacturing Cellular production team using real time process control takes over to ensure



EMI Shielding & Non-Conductive Thermoplastics

Parker Chomerics is in a unique position to offer housing material choices using either EMI Shielding electrically conductive PREMIER or non-conductive thermoplastics.

PREMIER is available in two polymer grades, PC/ABS and PEI. Both are filled with a blend of nickel plated carbon fiber and nickel graphite powder. The engineered filler blend results in high shielding performance at lower volume filling, allowing a high retention of base polymer mechanical characteristics.

The single pellet material allows cost effective injection molding as with any other filled polymer system.

Since PREMIER injection molded parts need no secondary EMI coating they offer the highest potential for part cost reduction. Depending on part size, cost reductions of up to 60% are obtained. As compared to metal die castings, no machining is needed to obtain tolerance control. As compared to standard paint/plated plastics, no secondary operations are required to obtain shielding. The fillers within PREMIER increase the material cost so as the part size increases, the savings from EMI secondary coating operations are reduced.

PREMIER is chosen over non-conductive thermoplastic with secondary EMI coatings for parts with

- Low cosmetic requirements
- Small parts
- < 85 dB shielding effectiveness

Assembly operations on PREMIER are no different than non-conductive versions of the same base polymers. Paint can be applied; however due to the fiber a high gloss finish is not obtainable. A matte finish is recommended.

To learn more about PREMIER please go to:

www.parker.com/chomerics

Non-conductive thermoplastics with secondary EMI coatings are generally chosen in place of EMI shielding conductive thermoplastics for parts with:

- High cosmetic requirements
- High temperature
- Chemical resistance
- Low water absorption
- > 85 dB shielding effectiveness
- Thin walls (<1.0 mm)
- Large parts (>200 gram weight)

The choice of thermoplastic is influenced by environmental, mechanical, maximum temperature, flammability and part design needs. Our design engineers can work through your needs and design in the optimum material. A successful plastic part molding application combines all materials and processes to provide the optimal cost model.

Commonly used materials: ABS, PC, PC/ABS, PBT, PEI and Nylon all have grades which can be post molding treated with an EMI coating and provide shielding up to 100 dB. They each provide a unique performance versus cost benefit. Our expertise is not limited to these materials and we can process any polymer you may need. Let our design engineers evaluate your needs and make recommendations.

If you are considering a metal-to-plastic conversion, polymers with heat distortion temperatures up to 280 °C can be used to provide the desired performance.

Graph 10-1

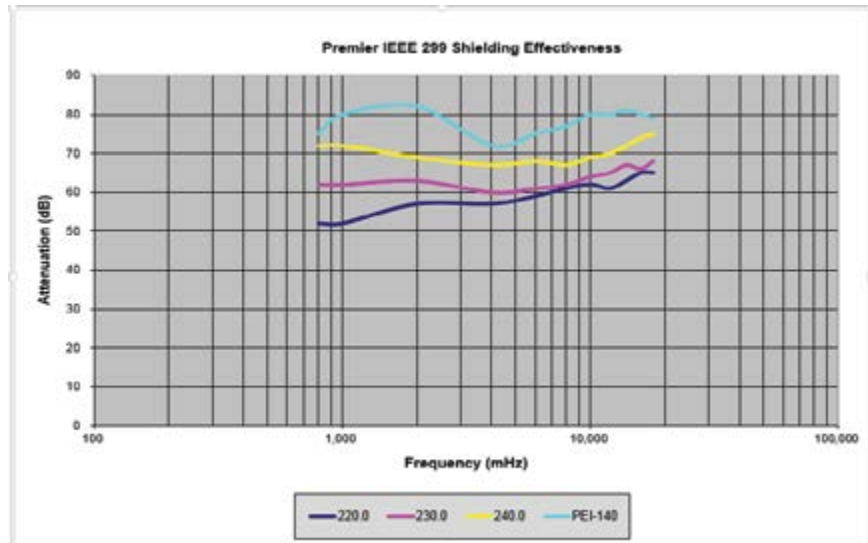

EMI Shielding Coating / Plating

There are many secondary operation technologies used to shield thermoplastic housings.

- Conductive paints
- Electroless plating selective & non-selective
- Sputtered vacuum metalization
- Thermal spray

We can have any of these applied to the housing either through in-house application or our authorized suppliers.

The primary factors to consider when choosing a secondary EMI coating are:

- Shielding effectiveness
- Environmental resistance
- Part geometry
- Part production volume

Applied material cost must be balanced with performance to find the best solution. Table 10-1 shows a relative ranking of the technologies.

Chomerics in-house selection of paints contains all commonly used filler and paint binders. They range from 50 dB controlled environment Ni/Acrylic to >90dB aerospace grade Ag/Epoxy systems. If we do not make the needed paint we will obtain it and apply it for you. We have in house painting abilities ranging from manual spray to robotic paint lines. These are complemented by an authorized paint spray supplier allowing us to provide the best solution.

Metalization by sputtering or plating are done by our authorized supplier base. Sputtered aluminum is a good solution in low shielding applications

where volume supports a higher tooling cost and the batch process. Plated nickel over copper can be done selectively or non-selectively for internal non-cosmetic parts. Ni/Cu provides excellent shielding, however it is not recommended for high humidity uncontrolled environments.

Thermal spray of tin-zinc by Parker Chomerics ECOPLATE® process provides high shielding with excellent resistance to harsh environments.

There is no single solution and all solutions vary in cost. Since Parker Chomerics is unique in offering all technologies, let our design engineers assist you in making the best choice for shielding your plastic housing at the lowest total cost of ownership.

Table 10-1: EMI Material Application - Relative Cost and Effectiveness

	Filler	Binder	Shielding Effectiveness 200 MHz to 18 GHz	Humidity Resistance	Maximum Operating Temperature	Solvent Resistance	Abrasion Resistance	Masking Tooling Cost	Batch Set Up Costs	Applied Cost
Paint	Ni	Acrylic	*	*	*	*	*	\$\$	\$	\$
	Ag/Cu	Acrylic	***	*	*	*	*	\$\$	\$	\$\$
	Cu	Urethane	***	****	****	****	***	\$\$	\$	\$\$\$\$
	Ag	Urethane	****	****	****	****	***	\$\$	\$	\$\$\$\$
	Ag	Epoxy	****	****	****	****	****	\$\$	\$	\$\$\$\$
Vacuum Metalization	Al	N/A	*	*	***	***	**	\$\$\$\$	\$\$\$\$	\$
Selective Plating	Ni/Cu	N/A	***	*	***	***	**	\$\$	\$\$	\$\$
Non-Selective Plating	Ni/Cu	N/A	***	*	***	***	**	\$	\$\$	\$
Thermal Arc Spray	Sn/Zn	N/A	****	****	****	****	****	\$\$\$\$	\$	\$\$

Legend	Lowest	Highest
Effectiveness	*	****
Cost	\$	\$\$\$\$

Optical Assemblies

Parker Chomerics offers a fully integrated plastic or glass optical assembly including housings, bezels, frames, gaskets, cosmetic finishing and supply chain for both EMI and non-shielding applications. We work with your design to incorporate all required mechanical, electrical and cosmetic requirements. We offer EMI compliance and safety testing at interim design stages or at final system certification.

Options for housings, bezels and frames include machined aluminum with Mil C 5541 Class 3 conversion coating or injection molded using Premier electrically conductive plastic or traditional thermoplastic with/without secondary EMI coating. The specifics of the application environment, cosmetic and electrical requirements, part geometry and cost targets will drive the choice for bezel/frame materials.

Parker Chomerics will integrate environmental and/or EMI gaskets, tapes, absorbers and thermal management materials into the optical solution. Our wide variety of indoor and outdoor EMI gaskets can be dispensed, or retained with adhesives or mechanical techniques. Materials range from fabric over foam to finger stock to elastomeric. Our line of soft elastomers (Shore A hardness <50) are an ideal choice for an EMI/environmental seal on an optical solution with a plastic housing, frame or bezel.

See Optical Products Brochure (SG 1006) for further details

Parker Chomerics will integrate pad printing, silk screening, hot stamping and decals. We can work with you to design and build the silk screening artwork and will obtain and maintain all tooling to add these features. A cosmetic exterior painting can be added using our authorized painting suppliers. Customer specified hardware can be incorporated along with a variety of final assembly techniques including heat staking and sonic welding to complete the integrated optical solution.

Touchscreens and other user enhancements can be integrated into the optical assembly. Optical bonding materials and techniques are available to improve sunlight readability, optical clarity and contrast enhancement while reducing reflection and the possibility of lamination contaminants.

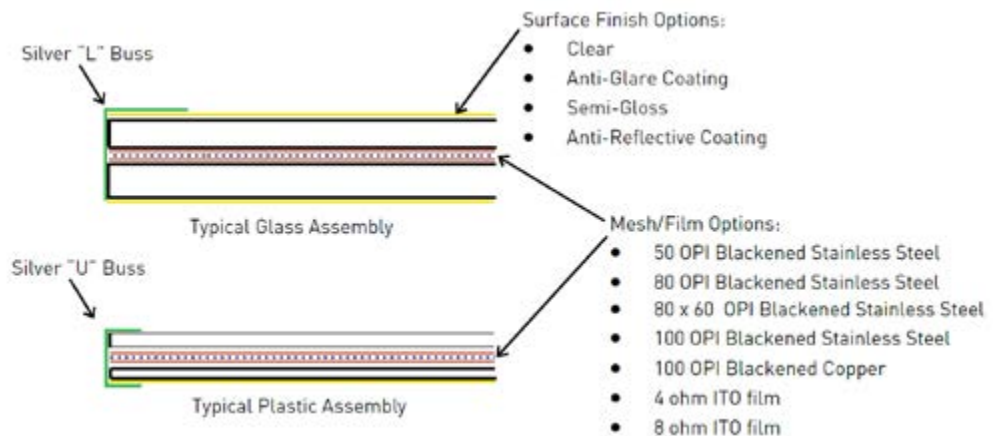
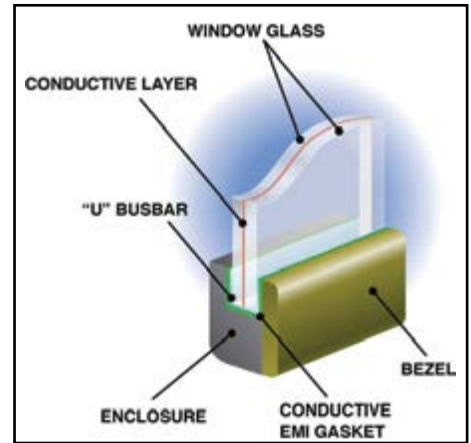

Figure 10-1

Secondary Assembly, EMI Gasketing/Thermal Management

SECONDARY ASSEMBLY

Often plastic housings need assembly of secondary components whose features could not be designed into the base part. Parker Chomerics can assemble these elements onto the housing using:

- Heat staking
- Sonic welding
- Solvent bonding
- Mechanical attachment

Depending on the part, assembly is often done at the injection molding press within the cycle time. If we cannot mold these components we will source them including threaded inserts and attachment hardware. The unit is ready for final assembly.

COSMETIC FEATURES

Parker Chomerics can supply component or part decorating using:

- Pad printing
- Silk screening
- Hot stamping
- Decals

All we need is the base artwork and we will obtain and maintain all tooling to add these features. A cosmetic exterior coating can be added using our authorized painting suppliers.



GASKETING (4,5,6)

For many devices an EMI shielding gasket is needed to complete the shielding design. Parker Chomerics has a complete line of EMI gasketing grades that can be installed on the part. For indoor or outdoor applications we have the material. The gaskets can become an integral part of the housing using

- Overmolding
- Dispensing
- Adhesives
- Mechanical retention

This simplifies final assembly allowing you to have only one part to order, inventory and handle. Materials range from fabric over foam to finger stock to elastomeric. Our line of soft elastomers (Shore A hardness <50) are a perfect solution for an environmental/EMI seal on plastics housings.

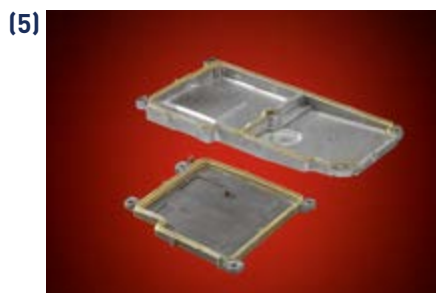
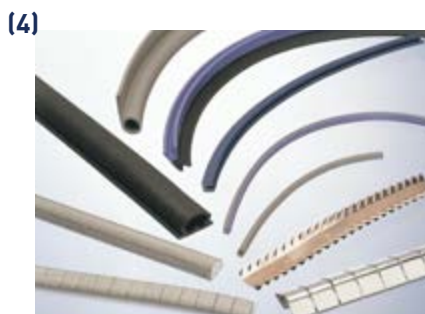

THERMAL MANAGEMENT (2)

Electronic devices often generate excessive amounts of heat during operation which must be channeled from the device. Using heat sinks or other active cooling devices, we can provide thermal management. We can supply these elements on the unit by insert molding or post molding attachment. The thermal elements can be supplied with thermal interface materials ready to efficiently transfer the heat.

Parker Chomerics can also integrate honeycomb based EMI airflow filters to improve a thermoplastic housings shielding and cooling performance.

MICROWAVE ABSORBER MATERIALS

High frequency devices for telecom, medical and military systems often use microwave absorber pads made from powder filled silicone or foam materials. Parker Chomerics can integrate these materials into a plastic housing assembly for higher performance attenuation.

TAPES, FOIL AND FILM LAMINATES (1,3)

Parker Chomerics can integrate fabric or foil tapes with electrically conductive adhesive and or foil/film based faraday cage laminates or ground straps as part of a system solution.



EMI Compliance & Safety Testing

Parker Chomerics can build the EMI shielded housing and then verify performance. Our Test Services Business unit with over 35 years of experience can review EMI package and board level design to avoid compliance testing failures when the product is ready to launch. We offer compliance testing for emissions, immunity, susceptibility and safety requirements for commercial, military and government electronics.

The laboratories have a full range of EMC testing sites

- 3 & 10 meter open field
- Semi-anechoic absorber cone shielded room
- Full anechoic ferrite lined shielded room

We can perform EMC testing to FCC, Industry Canada (IC), CISPR, VCCI, AUSTEL, EN, DO-160, MIL-STD 461 and automotive standards. We can provide your FCC Part 15/18 Class A/B test and submittal for certification.



Parker Chomerics performs safety testing for compliance with the European Low Voltage, Medical Device and Machinery directives. We can prepare safety evaluation to the European requirement with reports for a Manufacturers Technical Construction File and allow a company to apply the CE mark. We have accreditations for

- FCC
- AUSTEL
- VCCI
- NARTE
- A2LA
- CSA
- BSMI
- KOREA
- Industry Canada

Only Parker Chomerics can assist with design, manufacture and verify your device. This decreases your design cycle, time to market and avoids re-design costs to fix non-compliance problems.

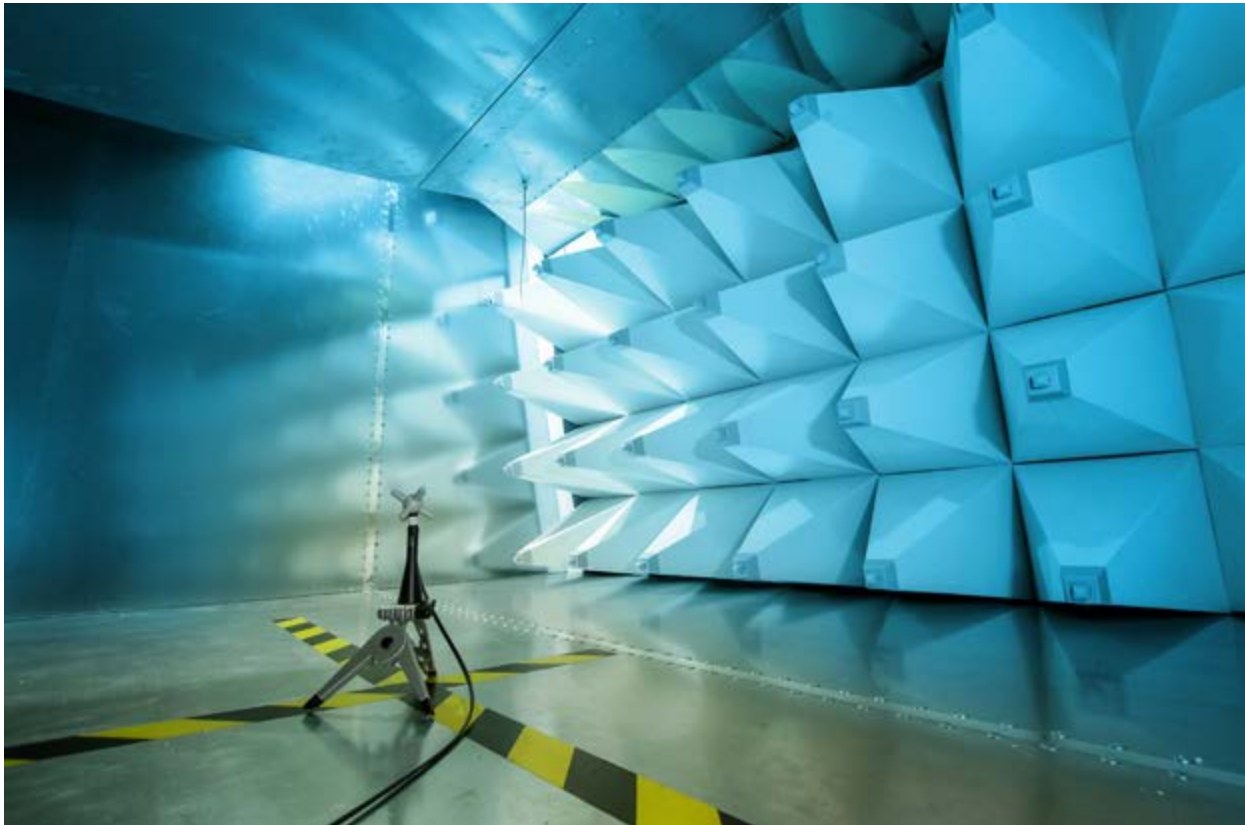

Supply Chain Management

Parker Chomerics can supply a thermoplastic EMI shielded housing for application in any environment. With over 45 years experience in EMI shielding we have materials and know-how to provide a total solution from a single point source for the design support, manufacture and verification testing. No other supplier has the breadth of material technology to provide cost effective materials and technology

- Plastic design support service
- EMI applications support
- In-house injection molding
- EMI shielding thermoplastics
- EMI shielding coatings
- EMI shielding display filters
- EMI shielding gaskets
- EMI shielding honeycomb filters
- Microwave absorbing materials
- Tapes, foil/film laminates
- Thermal management
- Secondary assembly
- Cosmetic finishing
- EMI Testing
- Safety Testing
- Global supply chain access with worldwide Parker Chomerics facilities

By combining these services we can reduce your cost for shielded plastic housings or enable metal-to-plastic conversions to provide

- Cost savings of up to 60%
- Reduce your design cycle
- Reduce your supplier base
- Reduce your assembly costs through part consolidation
- Eliminate re-design at the EMI certification stage
- On time product launch

No EMI shielding or environment is too harsh for Parker Chomerics to provide a solution to. We have material choices that provide durability and long term stability to satisfy application requirements for equipment in

- Telecom infrastructure
- Ruggedized PC's and handheld electronics
- Military electronics
- Aerospace electronics
- Medical electronics
- Automotive electronics

We have processing technology to convert our materials into your custom part at the lowest possible cost of ownership. We can simplify your supply chain and ensure ongoing quality and on-time delivery by eliminating multiple suppliers.

In metal to plastic conversions we can offer designs that reduce weight by up to 75% as compared to aluminum die castings. This will increase fuel efficiency for mobile applications or reduce fatigue for portable electronics.

Contact Parker Chomerics to learn more about our EMI Shielded Thermoplastic Housing Supply Service.

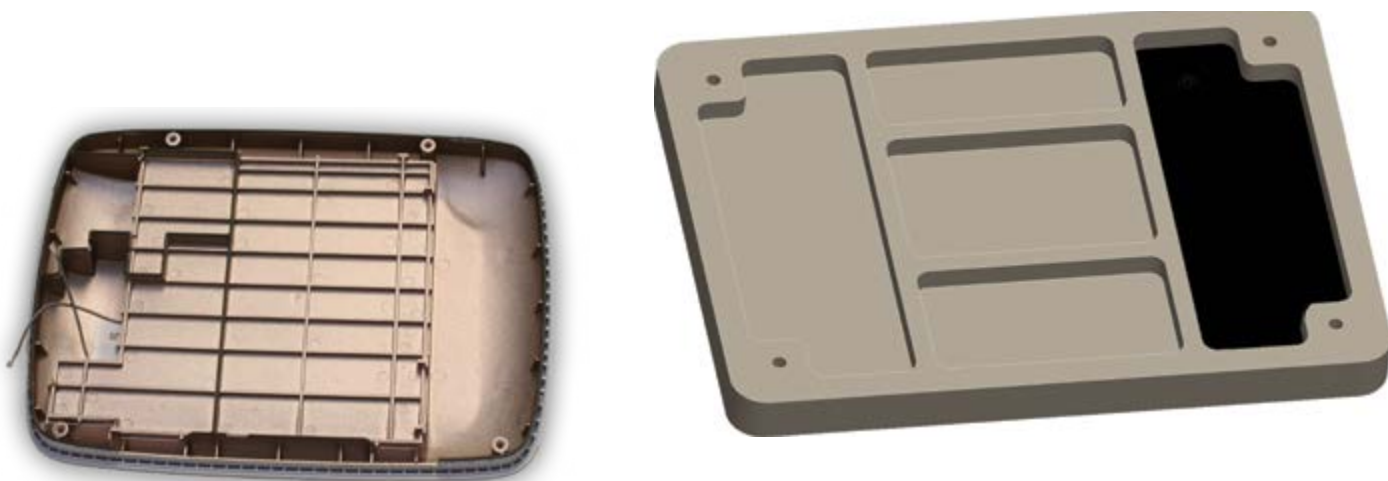

Dispensed EMI & Environmental Gaskets on Plastic or Metal Housings

Parker Chomerics Elastomers Business Unit offers a wide variety of integrated solutions utilizing dispensed EMI & environmental gaskets on plastic or metal substrates. By combining our in-house plastic injection molding with dispensed gasketing and supply chain options, we offer a complete solution ready to integrate at the customer's highest level of assembly.

We also offer in-house and outsourced metal housing options including machined aluminum (with corrosion resistant coatings as required), castings and stampings as the foundation for our dispensed gasket integrated solution. Our applications engineering team will work with you to specify the appropriate substrate and finishes, gaskets, required supply

chain content and even help complete the final level assembly drawing.

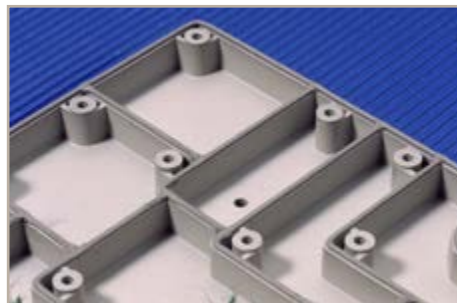
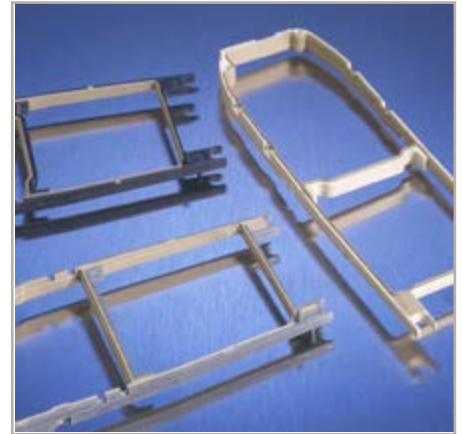

Conductive Elastomer Overmolded Solutions On Plastic & Metal

Conductive elastomer overmolded solutions can be designed with plastic or metal substrates. Over the years, elastomer overmolds on plastic have been used as conductive spacer board shields on handheld electronic devices, charger stations for medical devices and flexible conductive switches. Selection of a high temperature plastic and part design, gasket design including finite element analysis and final packaging for easy integration into a customer assembly are all features of a plastic based conductive elastomer overmold.

The same conductive elastomer overmolds can be supplied on a variety of metal substrates. These can include stamped metal cans, metal faceplates or covers, knitted wire mesh shrouds and plated or chromate conversion coated machined aluminum housings. The gasket overmold can include formed bead conductive/non-conductive perimeter seals.

Conductive elastomer overmolds on metal have been specified on a wide variety of military (Vulcanized Covers & Vulcon™), medical and commercial applications. Chomerics in-house machined metal substrate capabilities are often instrumental in supporting both customer prototyping and production ramp-up efforts.

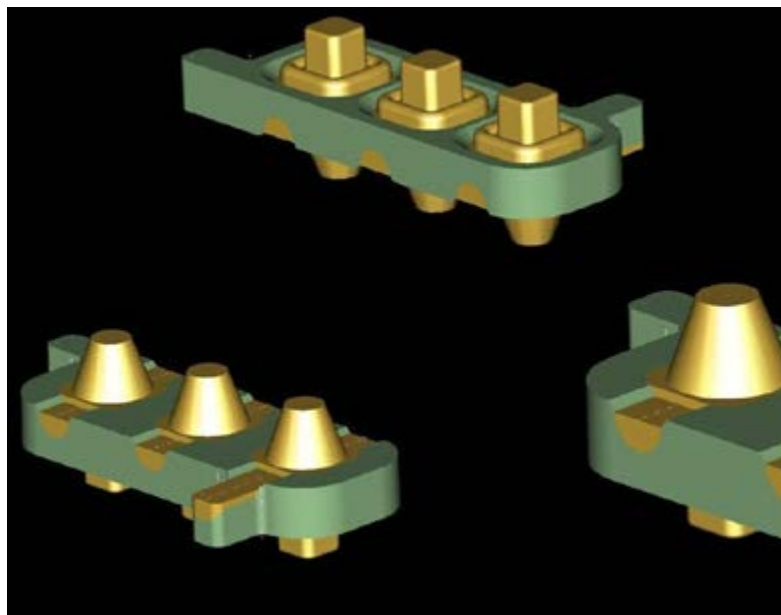

Parker Chomerics Capabilities

Thermal Management



Thermally Conductive Gels

Highly conformable, high performance fully cured single-component dispensable gap filler ideal for high volume automated dispense processes.

Typical Applications: Telematics, ECU's, EPAS, batteries.

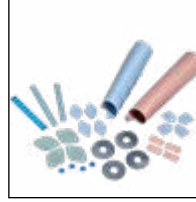

Thermal Insulators

Available in several forms, these materials are designed for use where the highest possible thermal, dielectric and mechanical properties are required.

Typical Applications: Power train, lighting, braking, sensors, ECU's.



Thermal Gap Fillers

Low modulus thermally conductive gap pads offer ease of use, excellent thermal properties and highest conformability for low to moderate clamping force applications.

Typical Applications: A/V systems, ACC, braking, battery ECU's.



Phase Change Materials

Designed to minimize the thermal resistance between power dissipating electronic components and heat sinks, these materials provide superior long term reliability performance.

Typical Applications: ABS, braking, wiper, transmission, battery.

EMI Shielding & Grounding



Fabric over Foam Gaskets |

SOFT-SHIELD® EMI gasketing products bring new flexibility to shielding decisions. They offer material choices, performance levels, configurations and attachment methods.

Typical Applications: Telematics, ITE, Medical and Commercial.



Wire and Expanded Metal Gasketing

Metal-based gaskets solutions for Electromagnetic Interference (EMI) and Electromagnetic Pulse (EMP) shielding as well as lightning strike protection.

Typical Applications: Connector, Cabinet and Military.



Laminates and Grounding Products

Mechanical, electrical and processing properties plus economy for commercial applications.

Typical Applications: EMI Shields, ground planes, ground straps and ESD shields.

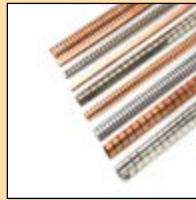

Beryllium Copper and Stainless Steel Gaskets

Beryllium-copper (BeCu) and stainless steel EMI gaskets (SPRING-LINE®) combine high levels of shielding effectiveness with a broad deflection range and low closure force properties.

Typical Applications: Cabinet, Enclosures, Commercial and Military.

Integrated Display Solutions

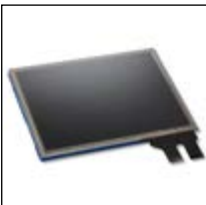

CHO-TOUCH Touchscreen LCDs

Parker Chomerics has designed these touchscreen LCDs for harsh environments such as military, medical, avionics, and general industrial.

Typical Applications: Military, Medical, Aerospace.

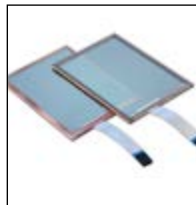

EMI Shielded Touchscreens and Windows

EMI Shielded touchscreens for rugged performance meeting critical EMC needs. Glass and polycarbonate windows for EMI Shielding and mechanical protection.

Typical Applications: Military, Medical, Aerospace.

Conductive Plastics



Conductive Plastics

Blend of thermoplastic and conductive fillers that provides world class shielding effectiveness and requires no machining, plating, painting or other added processing steps.

Typical Applications: ACC, sensors, battery, airbag, dashboard, lighting.

Conductive Compounds



Specialty Materials

Offering a wide variety of adhesives, caulks, sealants and coatings.

Typical Applications: EMI/RFI Shielding, Component and module caulking and sealing, ITE and Medical.

For detailed information on the products refer to www.Parker.com/Chomerics

GLOSSARY OF TERMS

ELECTRICAL

Absorption Loss: Attenuation of an electromagnetic wave or energy encountered in penetrating a shield caused by the induction of current flow in the barrier and the resulting I²R loss. Usually stated in dB (decibels).

Ambient Electromagnetic Environment: That electromagnetic field level existing in an area and emanating from sources other than the system under test.

Attenuation: A reduction in energy. Attenuation occurs naturally during wave travel through transmission lines, waveguides, space or a medium such as water, or may be produced intentionally by inserting an attenuator in a circuit or a shielding absorbing device in the path of radiation. The degree of attenuation is expressed in decibels or decibels per unit length.

Attenuator: An arrangement of fixed and/or variable resistive elements used to attenuate a signal by a desired amount.

Cross Coupling: Coupling of the signal from one channel to another where it becomes an undesired signal.

Conductivity: Capability of a material to conduct electrical currents.

Decibel (dB): A convenient method for expressing voltage or power ratios in logarithmic terms. The number of such units of attenuation, N is

$$N \text{ (dB)} = 10 \log \frac{P_1}{P_2}$$

where

P_1/P_2 is a unitless power ratio. N can also be expressed in terms of a voltage ratio E_1/E_2 as follows:

$$N \text{ (dB)} = 20 \log \frac{E_1}{E_2}$$

Degradation: An undesired change in the operational performance of a test specimen. Degradation of the operation of a test specimen does not necessarily mean malfunction.

Dielectric Loss Tangent: This quantifies a materials inherent dissipation of electromagnetic energy

to heat. The dielectric loss tangent is defined by the angle between the capacitors impedance vector and the negative reactive axis.

Electromagnetic Compatibility (EMC): A measure of an equipment's ability to neither radiate nor conduct electromagnetic energy, or to be susceptible to such energy from other equipment or an external electromagnetic environment.

Electromagnetic Interference (EMI): Undesired conducted or radiated electrical disturbances, including transients, which can interfere with the operation of electrical or electronic equipment. These disturbances can occur anywhere in the electromagnetic spectrum.

Emanation: Undesired electromagnetic energy radiated or conducted from a system.

Electromagnetic Waves: Electromagnetic waves come in three forms – Magnetic, Electric and Plane Wave as follows;

Magnetic Field or H-Field: An induction field caused predominantly by a current source. Also called a low impedance source, such as may be generated by a loop antenna.

Electrical or E-Field: A field induced by a high impedance source, such as a short dipole.

Plane Wave: An electromagnetic wave which exists at a distance greater than a wavelength from the source, where the impedance of the wave is nearly equal to the impedance of free space – 377 ohms.

Electromagnetic Pulse: A short burst of high electromagnetic energy

Gasket-EMI: A material that is inserted between mating surfaces of an electronic enclosure to provide low resistance across the seam and thereby preserve current continuity of the enclosure.

Ground: A reference plane common to all electronic, electrical, electromechanical systems and connected to earth by means of

a ground rod, ground grid, or other similar means.

Hertz: An international designation for cycles per second (cps).

Insertion Loss: Measure of improvement in a seam, joint or shield by the addition of a conductive gasket. Usually stated in dB.

Interference: Any electromagnetic phenomenon, signal or emission, man-made or natural, which causes or can cause an undesired response, malfunctioning or degradation of performance of electrical or electronic equipment.

Immunity: The ability of a device or equipment to resist malfunctioning when exposed to external electromagnetic interference.

Impedance: The measure of the opposition that a circuit (seem interface) presents to a current when a voltage is applied.

Malfunction: A change in the equipment's normal characteristics which effectively destroys proper operation.

NRL Arch: The Navel Research Laboratory (NRL) developed test method for reflectivity of flat absorber materials

Permeability: The capability of a material to be magnetized at a given rate. It is a non-linear property of both the magnetic flux density and the frequency of wave propagation.

Permittivity: The ability of a substance to store electrical energy in an electric field.

Radio Frequency (RF): Any frequency at which coherent electromagnetic radiation of energy is possible. Generally considered to be any frequency above 10 kHz.

Radio Frequency Interference (RFI): Used interchangeably with EMI. EMI is a later definition which includes the entire electromagnetic spectrum, whereas RFI is more restricted to the radio frequency band, generally considered to be between the limits 10 kHz to 10 GHz.

GLOSSARY OF TERMS

Reflection Loss: Attenuation of the electromagnetic wave or energy caused by impedance mismatch between the wave in air and the wave in metal

Relative Conductivity: Conductivity of the shield material relative to the conductivity of copper.

Relative Permeability: Magnetic permeability of the shield material relative to the permeability of free space.

Shield: A metallic configuration inserted between a source and the desired area of protection which has the capability to reduce the energy level of a radiating electromagnetic field by reflecting and absorbing the energy contained in the field.

Shielding Effectiveness: A measure of the reduction or attenuation in electromagnetic field strength at a point in space caused by the insertion of a shield between the source and that point. Usually stated in dB.

Shielding Increase: The difference of an electromagnetic field amplitude emanating through a seam (measured under fixed test conditions) with and without the gasket in the seam, with the force joining the seam remaining constant. The difference is expressed in dB based on voltage measurements.

Skin Depth: Distance which a plane wave must travel through a shield to be attenuated $1/e$, or approximately 37 percent of its original value. It is a function of the shield's conductivity and permeability and the wave's frequency.

Skin Effect: Increase in shield resistance with frequency because of crowding of current near the shield surface because of rapid attenuation of current as a function of depth from the shield surface.

Surface Treatment: Coating or plating of mating surfaces of a junction.

Susceptibility: Measure of the degradation of performance of a system when exposed to an electromagnetic environment.

Shielding Effectiveness: The difference of an electromagnetic amplitude emanating from a source within an enclosure, and that from a source in free space. The difference is expressed in dB based on voltage measurements.

Volume Resistivity: A resistance measurement which takes sample thickness into account. Units of measurement are typically ohm-cm.

Wave Impedance: The ratio of electric field intensity to magnetic field intensity.

Wavelength: The wavelength of a sinusoidal wave is the spatial period of the wave – the distance over which the wave's shape repeats.

MECHANICAL

Abrasion Resistance: The resistance of a material to wearing away by contact with a moving abrasive surface. Usefulness of standard tests very limited. Abrasion resistance is a complex of properties: resilience, stiffness, thermal stability, resistance to cutting and tearing.

Cold Flow: Continued deformation under stress.

Compression Set: The decrease in height of a specimen which has been deformed under specific conditions of load, time, and temperature. Normally expressed as a percentage of the initial deflection (rather than as a percentage of the initial height).

Compression Strength: The capacity of a material or structure to withstand loads tending to reduce size.

Compression Modulus: The mechanical property of linear elastic solid materials where you measure the force that is needed to stretch a material sample.

Conversion Coating: A protective surface layer on a metal that is created by a chemical reaction between the metal and a chemical solution typically applied in accordance with MIL-DTL-5541. Type 1 Conversion Coating is Hexavalent CR3 Type. Type 2 Conversion Coating is Trivalent CR6 Type.

CBRN: Chemical, Biological, Radiological and Nuclear exposure. Current term for NBC.

CVCM: Collected Volatile Condensable Materials – A measurement of Outgassing.

Durometer: An instrument for measuring the hardness of rubber. Measures the resistance to the penetration of an indenter point into the surface of the rubber.

Density: The relationship between the mass of a substance and how much space it takes up (volume).

Elasticity: The property of an article which tends to return to its original shape after deformation.

Elastic Limit: The greatest stress which a material is capable of developing without a permanent deformation remaining after complete release of the stress. Usually this term is replaced by various load limits for specific cases in which the resulting permanent deformations are not zero but are negligible.

Elastomer: A general term for elastic, rubber-like substances.

Elongation: Increase in length expressed numerically as a fraction or percentage of initial length.

EPDM: Ethylene Propylene Diene M-Class Synthetic Rubber used for gaskets in harsh environments – NBC Military applications.

Fatigue Strength: The amplitude or range of cyclic stress that can be applied to a material without causing fatigue failure – endurance limit.

Ferrex: Tin plated, copper clad stainless steel wire.

Flammability Rating: The classification of plastics according to how they burn in various orientations and thicknesses. The standard for Safety of Flammability is UL-94 published by Underwriters Laboratory.

GLOSSARY OF TERMS

Flexural Strength: Known as the modulus of rupture, bend strength or rupture strength. The stress in a material just before it yields in a flexure test.

Flexural Modulus: The ratio of stress to strain in flexural deformation or the tendency of a material to bend.

Fluorosilicone: A silicone polymer chain with fluorinated side-chains for improved oil and fuel resistance.

Fluorosilicone: A silicone polymer chain with fluorinated side-chains for improved oil and fuel resistance.

FEA: Finite Element Analysis (FEA) – Mechanical modeling software. Mechanical displacement formulations method to calculate component displacements, strains and stresses under internal and external loads.

Galvanic Corrosion: The process by which dissimilar metals in contact with each other oxidize or corrode. Must have dissimilar metals, electrical conductivity between them and the conductive path must allow the metal ions to move from the anodic to cathodic metal.

Galvanic Compatibility: Dissimilar metals that corrode little or none in a corrosive environment.

Gravimetric Weight Loss: The loss in metal created by corrosion when two dissimilar metals are in contact in a corrosive environment.

Hardness: Relative resistance of rubber surface to indentation by an indenter of specific dimensions under a specified load. (See Durometer). Numerical hardness values represent either depth of penetration or convenient arbitrary units derived from depth of penetration. Devices for measuring rubber hardness are known as durometers and plastometers. Durometers are used most commonly. The higher the durometer number, the harder the rubber, and vice versa.

Hardness Shore A: Durometer reading in degrees of hardness using a Type A Shore durometer. (Shore A hardness of 35 is soft; 90 is hard).

HDT: Heat Deflection Temperature (HDT) – is the temperature at which a polymer of plastic sample deforms under a specific load.

Hygroscopic: The ability of a substance to attract and hold water molecules from the surrounding environment. Also termed “wick”.

Izod Impact: The kinetic energy needed to initiate fracture and continue the fracture until the specimen is broken.

LOI - Limited Oxygen Index: Is the minimum concentration of oxygen, expressed as a percentage, that will support combustion of a polymer.

Modulus of Elasticity: The ratio of the stress applied to a body or substance to the resulting strain within the elastic limit.

Monel: A family of alloys primarily composed of nickel and copper with small amounts of Iron, Manganese, Carbon and Silicone.

NBC: Nuclear, Biological, and Chemical exposure.

Outgassing: The release of gas that was dissolved, trapped, frozen or absorbed in a material.

Permeability: A measure of the ease with which a liquid or gas can pass through a material.

Permanent Set, Stress and Strain Relaxation: Permanent Set is defined as the amount of residual displacement in a rubber part after the distorting load has been removed. Stress Relaxation, or Creep, is a gradual increase in deformation of an elastomer under constant load with the passage of time, accompanied by a corresponding reduction in stress level.

Resilience: The ratio of energy given up on recovery from deformation to the energy required to produce the deformation – usually expressed in percent.

RoHs Compliant: The Restriction of Hazardous Substances. European Directive 2002/95/EC restricts the use of specific hazardous materials found in electrical and electronic products.

SAE: Society of Automotive Engineers maintain committees to develop EMI gasket test standards.

Shear Modulus: The coefficient of elasticity for a shearing or torsion force.

Surface Treatment: Coating, plating or conversions coating of mating surfaces of a junction.

Specific Gravity: The ratio of the density of a substance to the density of a reference substance; equivalency.

Tear Strength: The force per unit of thickness required to initiate tearing in a direction normal to the direction of the stress.

Tensile Set: The residual elongation of a test sample after being stretched and allowed to relax in a specific manner.

Tensile Strength and Elongation: Tensile Strength is the force per unit of the original cross sectional area which is applied at the time of the rupture of the specimen during tensile stress. Elongation is defined as the extension between benchmarks produced by a tensile force applied to a specimen, and is expressed as a percentage of the original distance between the marks. Ultimate elongation is the elongation at the moment of rupture. Tensile Stress, more commonly called “modulus,” is the stress required to produce a certain elongation.

TML: Total Mass Loss – A measurement of outgassing – loss of weight.

Thermal Conductivity: The property of a material to conduct heat.

INDUSTRY ORGANIZATIONS and STANDARDS

ORGANIZATIONS

SAE: Society of Automotive Engineers

SAE AE4: SAE Committee for EMI Gasket Test Standard Development

UL: Underwriters Laboratories – Publishes Flammability Standards

IEEE: Institute of Electrical and Electronic Engineers

FCC: Federal Communications Commission – Government Regulator of EMI in the United States

AUSTEL: Australia Telecommunications Center

VCCI: Voluntary Control Council for Interference of Information Technology Equipment - Japan

NARTE: National Association of Radio and Telecommunications Engineers

A2LA: American Association for Laboratory Accreditation

IC: Industry Canada – Government Regulator of EMI in Canada

KNN RRA: Korean National Radio Research Agency

CSA: Canadian Standards Association

BSMI: Bureau of Standards, Metrology and Inspection - Taiwan

CISPR: International Special Committee on Radio Interference

EN: European Normative – Test Standards Approved in Europe

NASA-GSFC: National Aeronautics and Space Administration - NASA Goddard Space Flight Center

STANDARDS

MIL-DTL-83528: GASKETING MATERIAL, CONDUCTIVE, SHIELDING GASKET, ELECTRONIC, ELASTOMER, EMI/RFI GENERAL SPECIFICATION FOR

MIL-C-5015: CONNECTORS, ELECTRIC, CIRCULAR THREADED, AN TYPE, GENERAL SPECIFICATION FOR

MIL-C-26482: CONNECTORS, ELECTRICAL, (CIRCULAR, MINIATURE, QUICK DISCONNECT, ENVIRONMENT RESISTING), RECEPTACLES AND PLUGS, GENERAL SPECIFICATION FOR

MIL-C-38999: CONNECTORS, ELECTRICAL, CIRCULAR, MINIATURE, HIGH DENSITY, QUICK DISCONNECT (BAYONET, THREADED, AND BREECH COUPLING), ENVIRONMENT RESISTANT, REMOVABLE CRIMP AND HERMETIC SOLDER CONTACTS, GENERAL SPECIFICATION FOR

MIL-C-81511: CONNECTORS, ELECTRICAL, CIRCULAR, HIGH DENSITY, QUICK DISCONNECT, ENVIRONMENT RESISTING: AND ACCESSORIES GENERAL SPECIFICATION FOR

MIL-STD-810: ENVIRONMENTAL ENGINEERING CONSIDERATIONS AND LABORATORY TESTS

MIL-STD-1250: CORROSION PREVENTION AND DETERIORATION CONTROL IN ELECTRONIC COMPONENTS AND ASSEMBLIES

MIL-STD-454: STANDARD GENERAL REQUIREMENTS FOR ELECTRONIC EQUIPMENT

MIL-STD-461: REQUIREMENTS FOR THE CONTROL OF ELECTROMAGNETIC INTERFERENCE CHARACTERISTICS OF SUBSYSTEMS AND EQUIPMENT

MIL-STD-889: DISSIMILAR METALS

MIL-STD-83723: CONNECTORS, ELECTRICAL, (CIRCULAR, ENVIRONMENT RESISTING), RECEPTACLES AND PLUGS, GENERAL SPECIFICATION FOR

MIL-DTL-5541: CHEMICAL CONVERSION COATINGS ON ALUMINUM AND ALUMINUM ALLOYS

MIL-C-46168: COATING, ALIPHATIC POLYURETHANE, CHEMICAL AGENT RESISTANT

MIL-STD-285: ATTENUATION MEASUREMENTS FOR ENCLOSURES, ELECTROMAGNETIC SHIELDING FOR ELECTRONIC TEST PURPOSES, METHOD OF - CANCELED

MIL-C-28840: CONNECTORS, ELECTRICAL, CIRCULAR THREADED, HIGH DENSITY, HIGH SHOCK, SHIPBOARD, CLASS D GENERAL SPECIFICATION FOR

MIL-C-81511: CONNECTORS, ELECTRICAL, CIRCULAR, HIGH DENSITY, QUICK DISCONNECT, ENVIRONMENT RESISTING: AND ACCESSORIES GENERAL SPECIFICATION FOR

SAE ARP 1481: Corrosion Control and Electrical Conductivity in Enclosure Design.

MS 29513: PACKING, PREFORMED, HYDROCARBON FUEL RESISTANT

MS 9021: PACKING, PREFORMED, 'O' RING

INDUSTRY ORGANIZATION and STANDARDS—continued

ASTM-E595: Standard Test Method for Total Mass Loss and Collected Volatile Condensable Materials from Outgassing in a Vacuum Environment

ASTM STP576: Galvanic and Pitting Corrosion – Field and Laboratory Studies

ASTM-D395: Standard Test Methods for Rubber Property-Compression Set

ASTM-E59: Standard Specification for Cell-Type Oven with Controlled Rates of Ventilation

ASTM-B117: Standard Practice for Operating Salt Spray (Fog) Apparatus

ASTM-G85: Standard Practice for Modified Salt Spray (Fog) Testing

ASTM-D1329: Standard Specification for Safflower Oil

ASTM-D412: Standard Test Methods for Vulcanized Rubber and Thermoplastic Elastomers-Tension

ASTM-D624: Standard Test Method for Tear Strength of Conventional Vulcanized Rubber and Thermoplastic Elastomers

ASTM-D792: Standard Test Methods for Density and Specific Gravity (Relative Density) of Plastics by Displacement

ASTM-D2240: Standard Test Method for Rubber Property—Durometer Hardness

ASTM-D5470: Standard Test Method for Thermal Transmission Properties of Thermally Conductive Electrical Insulation Materials

ASTM-D1000: Standard Test Methods for Pressure-Sensitive Adhesive-Coated Tapes Used for Electrical and Electronic Applications

ASTM D638: Standard Test Method for Tensile Properties of Plastics

ASTM D790: Standard Test Methods for Flexural Properties of Unreinforced and Reinforced Plastics and Electrical Insulating Materials

ASTM D695: Standard Test Method for Compressive Properties of Rigid Plastics

ASTM-D256: Standard Test Methods for Determining the Izod Pendulum Impact Resistance of Plastics

ASTM-D648: Standard Test Method for Deflection Temperature of Plastics Under Flexural Load in the Edgewise Position

ASTM-D257: Standard Test Methods for DC Resistance or Conductance of Insulating Materials

ASTM-D2863: Standard Test Method for Measuring the Minimum Oxygen Concentration to Support Candle-Like Combustion of Plastics (Oxygen Index)

ASTM-D375: Standard Method of Test for KNOCK CHARACTERISTICS OF MOTOR FUELS OF 100 OCTANE NUMBER AND BELOW BY THE MOTOR METHOD

ASTM-D297: Standard Test Methods for Rubber Products-Chemical Analysis

ASTM-D2520: Standard Test Methods for Complex Permittivity (Dielectric Constant) of Solid Electrical Insulating Materials at Microwave Frequencies and Temperatures to 1650 Degrees C

ASTM-D624: Standard Test Method for Tear Strength of Conventional Vulcanized Rubber and Thermoplastic Elastomers

ASTM-D5470: Standard Test Method for Thermal Transmission Properties of Thermally Conductive Electrical Insulation Materials

IEEE STD-299: Method for Measuring the Effectiveness of Electromagnetic Shielding Enclosures

NAS-1599: Connectors, General Purpose, Electrical, Miniature Circular, Environment Resisting, 200 Degrees C Maximum Temperature

SAE ARP-1705: Coaxial Test Procedure to Measure the RF Shielding Characteristics of EMI Gasket Materials

SAE AMS-R-25988: Rubber, Fluorosilicone Elastomer, Oil-and-Fuel-Resistant, Sheets, Strips, Molded Parts, and Extruded Shapes

ZZ-R-765: RUBBER, SILICONE (GENERAL SPECIFICATION)

UL-94: Standard for Safety of Flammability of Plastic Materials published by Underwriters Laboratories

RTCA-DO-160: Radio Technical Commission for Aeronautics. Environments and EMI Test Standard for Commercial Avionics.

Chomerics Division Of Parker Hannifin Corporation

Terms And Conditions Of Sale

1. Terms and Conditions. Seller's willingness to offer Products for sale or accept an order for Products is subject to the terms and conditions contained in this Offer of Sale or any newer version of the same, published by Seller electronically at www.parker.com/saleterms/. Seller objects to any contrary or additional terms or conditions of Buyer's order or any other document or other communication issued by Buyer.

2. Price; Payment. Prices stated on Seller's Quote are valid for thirty (30) days, except as explicitly otherwise stated therein, and do not include any sales, use, or other taxes or duties unless specifically stated. Seller reserves the right to modify prices to adjust for any raw material price fluctuations or costs resulting from state, federal or local legislation.. Unless otherwise specified by Seller, all prices are F.C.A. Seller's facility (INCOTERMS 2010). Payment is subject to credit approval and payment for all purchases is due thirty (30) days from the date of invoice (or such date as may be specified by Seller's Credit Department). Unpaid invoices beyond the specified payment date incur interest at the rate of 1.5% per month or the maximum allowable rate under applicable law.

3. Shipment; Delivery; Title and Risk of Loss. All delivery dates are approximate. Seller is not responsible for damages resulting from any delay. Regardless of the manner of shipment, delivery occurs and title and risk of loss or damage pass to Buyer, upon placement of the Products with the shipment carrier at Seller's facility. Unless otherwise stated, Seller may exercise its judgment in choosing the carrier and means of delivery. No deferment of shipment at Buyers' request beyond the respective dates indicated will be made except on terms that will indemnify, defend and hold Seller harmless against all loss and additional expense. Buyer shall be responsible for any additional shipping charges incurred by Seller due to Buyer's acts or omissions.

4. Warranty. Seller warrants that the Products sold hereunder shall be free from defects in material or workmanship for a period of twelve (12) months from the date of delivery or 2,000 hours of normal use, whichever occurs first. All prices are based upon the exclusive limited warranty stated above, and upon the following disclaimer: **DISCLAIMER OF WARRANTY: THIS WARRANTY IS THE SOLE AND ENTIRE WARRANTY PERTAINING TO PRODUCTS PROVIDED. SELLER DISCLAIMS ALL OTHER WARRANTIES, EXPRESS AND IMPLIED, INCLUDING DESIGN, MERCHANTABILITY AND FITNESS FOR A PARTICULAR PURPOSE.**

5. Claims; Commencement of Actions. Buyer shall promptly inspect all Products upon receipt. No claims for shortages will be allowed unless reported to the Seller within ten (10) days of delivery. No other claims against Seller will be allowed unless asserted in writing within thirty (30) days after delivery. Buyer shall notify Seller of any alleged breach of warranty within thirty (30) days after the date the defect is or should have been discovered by Buyer. Any claim or action against Seller based upon breach of contract or any other theory, including tort, negligence, or otherwise must be commenced within twelve (12) months from the date of the alleged breach or other alleged event, without regard to the date of discovery.

6. **LIMITATION OF LIABILITY. IN THE EVENT OF A BREACH OF WARRANTY, SELLER WILL, AT ITS OPTION, REPAIR OR REPLACE A DEFECTIVE PRODUCT, OR REFUND THE PURCHASE PRICE WITHIN A REASONABLE PERIOD OF TIME. IN NO EVENT IS SELLER LIABLE FOR ANY SPECIAL, INDIRECT, INCIDENTAL OR CONSEQUENTIAL DAMAGES ARISING OUT OF, OR AS THE RESULT OF, THE SALE, DELIVERY, NON-DELIVERY, SERVICING, USE OR LOSS OF USE OF THE PRODUCTS OR ANY PART THEREOF, OR FOR ANY CHARGES OR EXPENSES OF ANY NATURE**

INCURRED WITHOUT SELLER'S WRITTEN CONSENT, WHETHER BASED IN CONTRACT, TORT OR OTHER LEGAL THEORY. IN NO EVENT SHALL SELLER'S LIABILITY UNDER ANY CLAIM MADE BY BUYER EXCEED THE PURCHASE PRICE OF THE PRODUCTS.

7. User Responsibility. The user, through its own analysis and testing, is solely responsible for making the final selection of the system and Product and assuring that all performance, endurance, maintenance, safety and warning requirements of the application are met. The user must analyze all aspects of the application and follow applicable industry standards and Product information. If Seller provides Product or system options based upon data or specifications provided by the user, the user is responsible for determining that such data and specifications are suitable and sufficient for all applications and reasonably foreseeable uses of the Products or systems.

8. Loss to Buyer's Property. Any designs, tools, patterns, materials, drawings, confidential information or equipment furnished by Buyer or any other items which become Buyer's property, will be considered obsolete and may be destroyed by Seller after two (2) consecutive years have elapsed without Buyer ordering the items manufactured using such property. Seller shall not be responsible for any loss or damage to such property while it is in Seller's possession or control.

9. Special Tooling. A tooling charge may be imposed for any special tooling, including without limitation, dies, fixtures, molds and patterns, acquired to manufacture Products.

Terms And Conditions Of Sale -continued

Such special tooling shall be and remain Seller's property notwithstanding payment of any charges by Buyer. In no event will Buyer acquire any interest in apparatus belonging to Seller which is utilized in the manufacture of the Products, even if such apparatus has been specially converted or adapted for such manufacture and notwithstanding any charges paid by Buyer. Unless otherwise agreed, Seller has the right to alter, discard or otherwise dispose of any special tooling or other property in its sole discretion at any time.

10. Buyer's Obligation; Rights of Seller. To secure payment of all sums due or otherwise, Seller retains a security interest in all Products delivered to Buyer and this agreement is deemed to be a Security Agreement under the Uniform Commercial Code. Buyer authorizes Seller as its attorney to execute and file on Buyer's behalf all documents Seller deems necessary to perfect its security interest.

11. Improper Use and Indemnity. Buyer shall indemnify, defend, and hold Seller harmless from any losses, claims, liabilities, damages, lawsuits, judgments and costs (including attorney fees and defense costs), whether for personal injury, property damage, patent, trademark or copyright infringement or any other claim, brought by or incurred by Buyer, Buyer's employees, or any other person, arising out of: (a) improper selection, application, design, specification or other misuse of Products purchased by Buyer from Seller; (b) any act or omission, negligent or otherwise, of Buyer; (c) Seller's use of patterns, plans, drawings, or specifications furnished by Buyer to manufacture Products; or (d) Buyer's failure to comply with these terms and conditions. Seller shall not indemnify Buyer under any circumstance except as otherwise provided.

12. Cancellations and Changes. Buyer may not cancel or modify or cancel any order for any reason, except with

Seller's written consent and upon terms that will indemnify, defend and hold Seller harmless against all direct, incidental and consequential loss or damage. Seller may change Product features, specifications, designs and availability.

13. Limitation on Assignment. Buyer may not assign its rights or obligations under this agreement without the prior written consent of Seller.

14. Force Majeure. Seller does not assume the risk and is not liable for delay or failure to perform any of Seller's obligations by reason of events or circumstances beyond its reasonable control (hereinafter "Events of Force Majeure"). Events of Force Majeure shall include without limitation: accidents, strikes or labor disputes, acts of any government or government agency, acts of nature, delays or failures in delivery from carriers or suppliers, shortages of materials, or any other cause beyond Seller's reasonable control.

15. Waiver and Severability. Failure to enforce any provision of this agreement will not invalidate that provision; nor will any such failure prejudice Seller's right to enforce that provision in the future. Invalidation of any provision of this agreement by legislation or other rule of law shall not invalidate any other provision herein. The remaining provisions of this agreement will remain in full force and effect.

16. Termination. Seller may terminate this agreement for any reason and at any time by giving Buyer thirty (30) days prior written notice. Seller may immediately terminate this agreement, in writing, if Buyer: (a) breaches any provision of this agreement (b) appoints a trustee, receiver or custodian for all or any part of Buyer's property (c) files a petition for relief in bankruptcy on its own behalf, or one if filed by a third party (d) makes an assignment for the benefit of creditors; or (e) dissolves its business or liquidates all or a majority of its assets.

17. Governing Law. This agreement and the sale and delivery of all Products are deemed to have taken place in, and shall be governed and construed in accordance with, the laws of the State of Ohio, as applicable to contracts executed and wholly performed therein and without regard to conflicts of laws principles. Buyer irrevocably agrees and consents to the exclusive jurisdiction and venue of the courts of Cuyahoga County, Ohio with respect to any dispute, controversy or claim arising out of or relating to this agreement.

18. Indemnity for Infringement of Intellectual Property Rights. Seller is not liable for infringement of any patents, trademarks, copyrights, trade dress, trade secrets or similar rights except as provided in this Section. Seller will defend and indemnify Buyer against allegations of infringement of U.S. patents, U.S. trademarks, copyrights, trade dress and trade secrets ("Intellectual Property Rights"). Seller will defend at its expense and will pay the cost of any settlement or damages awarded in an action brought against Buyer based on an allegation that a Product sold pursuant to this agreement infringes the Intellectual Property Rights of a third party. Seller's obligation to defend and indemnify Buyer is contingent on Buyer notifying Seller within ten (10) days after Buyer becomes aware of such allegations of infringement, and Seller having sole control over the defense of any allegations or actions including all negotiations for settlement or compromise. If a Product is subject to a claim that it infringes the Intellectual Property Rights of a third party, Seller may, at its sole expense and option, procure for Buyer the right to continue using the Product, replace or modify the Product so as to make it noninfringing, or offer to accept return of the Product and refund the purchase price less a reasonable allowance for depreciation.

Terms And Conditions Of Sale -continued

Notwithstanding the foregoing, Seller is not liable for claims of infringement based on information provided by Buyer, or directed to Products delivered hereunder for which the designs are specified in whole or part by Buyer, or infringements resulting from the modification, combination or use in a system of any Product sold hereunder. The foregoing provisions of this Section constitute Seller's sole and exclusive liability and Buyer's sole and exclusive remedy for infringement of Intellectual Property Rights.

19. Entire Agreement. This agreement contains the entire agreement between the Buyer and Seller and constitutes the final, complete and exclusive expression of the terms of sale. All prior or contemporaneous written or oral agreements or negotiations with respect to the subject matter are herein merged. The terms contained herein may not be modified unless in writing and signed by an authorized representative of Seller.

20. Compliance with Laws. Buyer agrees to comply with all applicable laws, regulations, and industry and professional standards of care, including those of the United Kingdom, the United States of America, and the country or countries in which Buyer may operate, including without limitation the U. K. Bribery Act, the U.S. Foreign Corrupt Practices Act ("FCPA"), the U.S. Anti-Kickback Act ("Anti-Kickback Act") and the U.S. Food Drug and Cosmetic Act ("FDCA"), each as currently amended, and the rules and regulations promulgated by the U.S. Food and Drug Administration ("FDA"), and agrees to indemnify

and hold harmless Seller from the consequences of any violation of such provisions by Buyer, its employees or agents. Buyer acknowledges that it is familiar with the provisions of the U. K. Bribery Act, the FCPA, the FDA, and the Anti-Kickback Act, and certifies that Buyer will adhere to the requirements thereof. In particular, Buyer represents and agrees that Buyer will not make any payment or give anything of value, directly or indirectly to any governmental official, any foreign political party or official thereof, any candidate for foreign political office, or any commercial entity or person, for the purpose of influencing such person to purchase Products or otherwise benefit the business of Seller.

Premier® Conductive Plastics Specific Terms and Conditions

Parker Chomerics' Premier® conductive plastics are sold under license solely for the molding of products for use in the following applications: (i) EMI/RFI shielding, i.e., electromagnetic and/or radio frequency interference shielding or compatibility and surface grounding therefor; (ii) earth grounding, corona shielding, and anti-static and/or electrostatic discharge protection shielding; and (iii) as thermally conductive members to dissipate heat generated by electronic devices.

The resale of Premier® conductive plastics in pellet or any other raw material form is expressly prohibited, as is their use in any application other than as stated above, and any such resale or use by you or your customers

shall render any and all warranties null and void ab initio.

You shall defend, indemnify, and hold Parker Hannifin Corporation and its subsidiaries ("Parker") harmless from and against any and all costs and expenses, including attorneys' fees, settlements, and any awards, damages, including attorneys' fees, and costs, resulting from any claim, allegation, suit or proceeding made or brought against Parker arising from any prohibited resale or use of PREMIER® conductive plastics by you or your customers.

Parker Chomerics Contact Locations

Chomerics Worldwide

Corporate Facilities

North America

Global Division Headquarters

77 Dragon Court
Woburn, MA
Phone +1 781-935-4850
Fax +781-933-4318

chomailbox@parker.com

Product Disclosure

(ROHS/REACH, Material
Declarations, SDS)

choproductdisclosure@parker.com

Europe

Parker Hannifin Ltd

Chomerics Division Europe

Unit 6, Century Point
Halifax Road
High Wycombe
Bucks HP12 3SL
UK
Phone +44 1494 455400
Fax +44 14944 55466

chomerics_europe@parker.com

Asia Pacific

Parker Hannifin

Chomerics Shanghai

280 Yunqiao Road, Jin Qiao Export
Processing Zone, Shanghai 201206,
China

Phone +86 21 2899 5000
Fax +86 21 2899 5146

chomerics_ap@parker.com

Parker Hannifin

Chomerics Shenzhen

No.5 Bldg Jinrongda Technologi-
cal Park Gangtou Village, Ban-
tian Longgang District Shenzhen,
518122, China

Phone +86 755 8974 8558
Fax +86 755 8974 8560

chomerics_ap@parker.com

Parker Hannifin

Chomerics Kuala Lumpur

Lot 15, Jalan Gudang 16/9
Section 16, Shah Alam
Industrial Estate, 40200 Shah Alam
Selangor, Malaysia

Phone +603 5510 9188
Fax +603 5512 6988

chomerics_ap@parker.com

Penang, Malaysia

No.3, Puncak Perusahaan 1, 13600
Prai, Penang, Malaysia

Phone +604 398329

Fax +604 3983299

chomerics_ap@parker.com

Parker Hannifin India Private Limited

Chomerics Division,

Plot No. 41/2, 8th Avenue DTA, Anjur
Village, Mahindra World City, Chen-
galpattu, Tamilnadu - 603 004, India

Phone +91 44 67132333

Phone +91 44 67132045

chomerics_ap@parker.com

Manufacturing Facilities

Woburn, MA; Hudson, NH; Cranford, NJ; Fairport, NY; Monterrey, Mexico; Grantham, UK; High Wycombe, UK; Sad-
ska, Czech Republic; Shanghai, PRC; Shenzhen, PRC; Penang, Malaysia; Kuala Lumpur, Malaysia; Chennai, India.

www.parker.com/chomerics



WARNING: The products described in this catalog can expose you to chemicals including Carbon black extracts, Naphthalene, N-methyl Pyrrolidone, Titanium Dioxide, Ethylene Oxide, Ethyl Benzene, Tetrafluoroethylene, Lead, Nickel Compounds, 1,3Butadiene, DiChloromethane, Chloroprene, Di(2-ethylhexyl)phthalate(DEHP), Antimony Oxide, which are known to the State of California to cause cancer, and Methyl Chloride, Lead, 1,3 Butadiene, Toluene, EthyleneOxide, Di(2-ethylhexyl)phthalate(DEHP) which are known to the State of California to cause birth defects or other reproductive harm. For more information go to www.P65Warnings.ca.gov.



Parker Chomerics Conductive Elastomer Engineering Handbook
MS EN 6/12/2020