

LOC J DIST

REVISIONS

変更

| P | LTR | DESCRIPTION | DATE | DWN | APVD |
|---|-----|---------------------------|-----------|-----|------|
| D | | REVISED PER ECR-15-011723 | 08AUG2015 | Y.O | E.T |

ワイヤーレンジ
WIRE RANGE
ID MARK

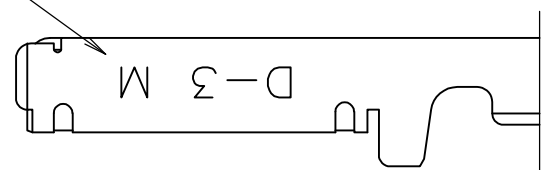

TOOLING ID MARK
ON OUTER SURFACE

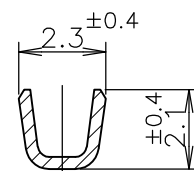

A-A

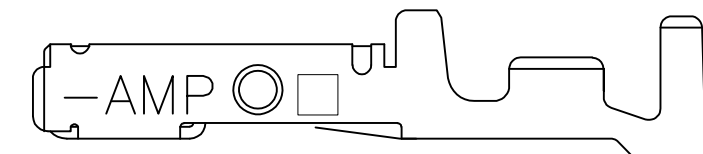
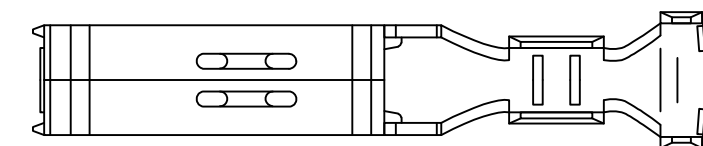

2-5 ONLY

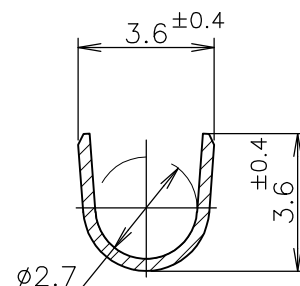
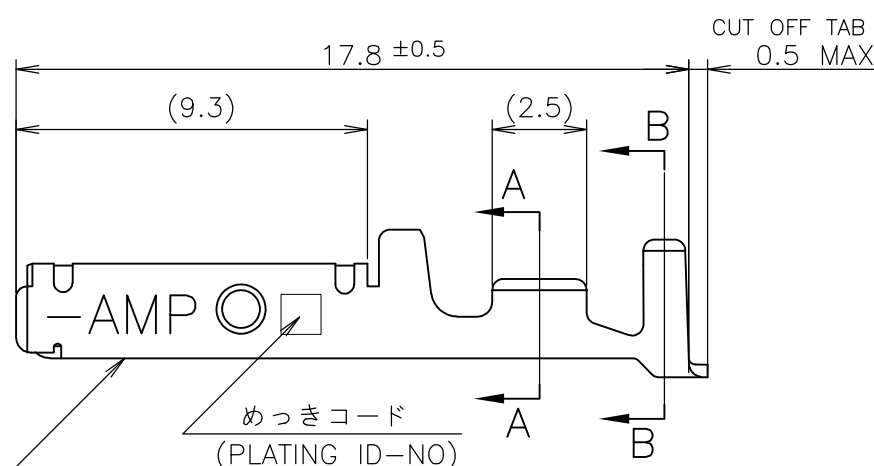
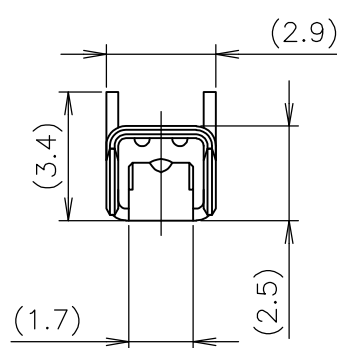

B-B

接圧表示
(PRESSURE ID-MARK)

めっきコード
(PLATING ID-NO)

- ① 標準接圧型コンタクト：一般向け及び多極用
- ② 高接圧型コンタクト：高電流用及び強振動用
- ③ 金めっきは接続部のみとする
- 4 製品規格：108-5349
- 5 取付け適用規格：114-5148

| 備考 (REMARK) | 接圧表示 (ID-MARK) | めっきコード (PL. ID NO) | 仕上 (FINISH) | 型番 (P/N) | |
|-------------|----------------|--------------------|------------------------------------|------------------------------------|------------|
| OBSOLETE | H | 5 | 光沢錫めっき (BRIGHT TIN-PL.) | 2-175217-5 | |
| | | 5 | 光沢錫めっき (BRIGHT TIN-PL.) | 1-175217-5 | |
| | | 3 | 0.76μm 最小金めっき (0.76μm MIN. Au-PL.) | 1-175217-3 | |
| | ① | INACTIVE | 2 | 0.38μm 最小金めっき (0.38μm MIN. Au-PL.) | 1-175217-2 |
| | | | 5 | 光沢錫めっき (BRIGHT TIN-PL.) | 175217-5 |
| | | | 3 | 0.76μm 最小金めっき (0.76μm MIN. Au-PL.) | 175217-3 |
| | | 2 | 0.38μm 最小金めっき (0.38μm MIN. Au-PL.) | 175217-2 | |

- ① CONTACT TYPE; LOW PRESSURE TYPE (FOR GENERAL)
- ② CONTACT TYPE; HIGH PRESSURE TYPE (FOR HIGH CURRENT OR ANTI-VIBRATION)
- ③ GOLD-PL. CONTACT AREA ONLY
- 4 PRODUCT SPEC: 108-5349
- 5 APPLICATION SPEC: 114-5148

| 単位: 耗 mm | 公差 |
|------------|-------|
| 10 ≥ | ±0.2 |
| 30 ≥ > 10 | ±0.25 |
| 100 ≥ > 30 | ±0.3 |
| ANGLES | ±3° |

THIS DRAWING IS A CONTROLLED DOCUMENT.

| | |
|--------------------------------|---|
| DIMENSIONS: 単位: 耗 mm | TOLERANCES UNLESS OTHERWISE SPECIFIED: 一般公差 |
| MATERIAL 材料 (COPPER ALLOY) 銅合金 | FINISH 仕上 (SEE TABLE) 表参照 |

DWN T-YONEBAYASHI 27JUN1990
 CHK H.OBATA 14FEB1991
 APVD S.MANABE 14FEB1991
 PRODUCT SPEC 製品規格
 APPLICATION SPEC 取付適用規格
 WEIGHT

WIRE RANGE 包合電線断面積 AWG 24-20 (0.2-0.5mmSQ) mm²
 INSULATION DIA 被覆外径 1.2-2.6 mmφ

STE TE Connectivity

M SIZE
 DYNAMIC SERIES REC. CONTACT L/P
 ダイナミックシリーズリセプタクルコンタクト L/P

SIZE A3 CAGE CODE 00779 DRAWING NO 番号 C-175217 RESTRICTED TO

CUSTOMER DRAWING SCALE 尺度 5:1 SHEET 1 OF 1 REV D

Mouser Electronics

Authorized Distributor

Click to View Pricing, Inventory, Delivery & Lifecycle Information:

[TE Connectivity:](#)

[175217-2](#)