

Customer Part:



Description

- Surface mount temperature compensated voltage controlled crystal oscillator.
- Freq Adj option
Option A (standard):
Ageing adjustment by means of external Control Voltage applied to pad 1
Range (frequency ≤ 20MHz) ≥ ±5ppm
Range (frequency > 20MHz) ≥ ±7ppm
Linearity ≤2%
Slope Positive
Input resistance ≥100kΩ
Modulation bandwidth ≥2kHz
Standard control voltage range 1.5V±1V
- Model CFPT-9301-A
- Model Issue number 7

Frequency Parameters

- Frequency 50.0MHz
- Frequency Tolerance ±1.00ppm
- Frequency Stability ±1.00ppm
- Operating Temperature Range -40.00 to 85.00°C
- Ageing ±1ppm max in 1st year (see Note 1)
- Supply Voltage Variation (@ ±5% change):
Frequency <20MHz: ±0.1ppm typ
Frequency 20MHz to <35MHz: ±0.3ppm typ
Frequency 35MHz to 52MHz: ±0.5ppm typ
- Load Variation (@ ±5pF change):
Frequency <20MHz: ±0.2ppm typ
Frequency 20MHz to <35MHz: ±0.3ppm typ
Frequency 35MHz to 52MHz: ±0.5ppm typ
- Note 1 Ageing:
Frequency ≤20MHz: ±1ppm max in 1st year
Frequency ≤20MHz: ±3ppm max for 10 years (including the 1st year)
Frequency >20MHz: ±2ppm max in 1st year
Frequency >20MHz: ±5ppm max for 10 years (including the 1st year)

Electrical Parameters

- Supply Voltage 3.3V ±10%
- Supply Current (typical):
HCMOS: $1 + \text{Frequency(MHz)} * \text{Supply(V)} * \{\text{Load(pF)} + 15\} * 1E-3\text{mA}$
i.e @ 20MHz, 3.3V, 15pF ≈ 3mA
Calculation: $1 + (20 \times 3.3 \times (15 + 15) \times 0.001) = 2.98\text{mA}$
- Supply Voltage Tolerance: Parts will operate correctly with ±10% supply voltage variation but supply coefficient is measured with ±5% variation
- Frequency Adjustment - option B
No frequency adjustment
Initial calibration: ≤ ±1.0ppm

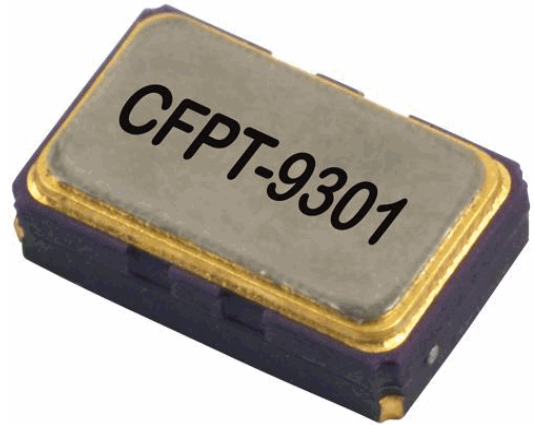

Outline (mm)

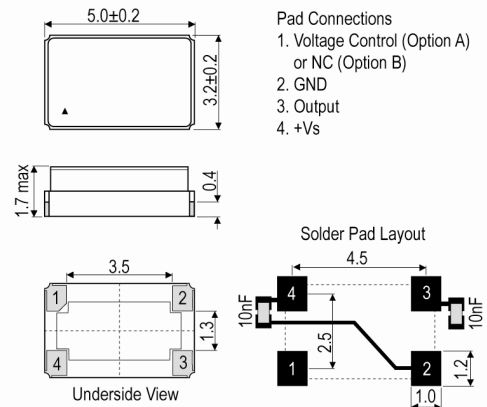

Test Circuit

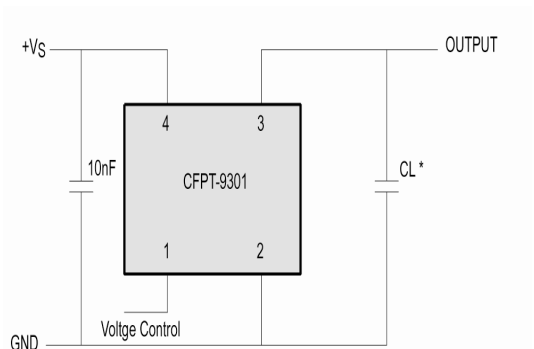

* Load 15pF (HCMOS), inclusive of probe and jig capacitance

Sales Office Contact Details:

UK: +44 (0)1460 270200
Germany: 0800 1808 443

France: 0800 901 383
USA: +1.760.318.2824

Email: info@iqdfrequencyproducts.com
Web: www.iqdfrequencyproducts.com

Customer Part:

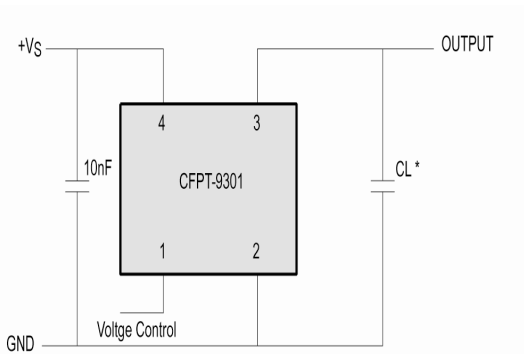

* Load 15pF (HCMOS), inclusive of probe and jig capacitance

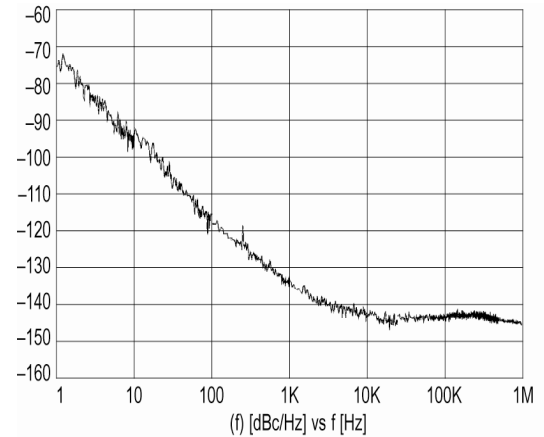

Chipset Approval Table

Ref No.	Frequency	Chipset Type	IC Supplier
E4190LF	12.8MHz	ACS1790T, ACS9510, ACS9520T, ACS9522T, ACS9550, ACS9593T, ACS8522BT, ACS8509, ACS8510, ACS8514, ACS8515, ACS8520, ACS8520A, ACS8522	Semtech
E4191LF	12.8MHz	ACS1790T, ACS9510, ACS9520T, ACS9522T, ACS9550, ACS9593T, ACS8522BT, ACS8509, ACS8510, ACS8514, ACS8515, ACS8520, ACS8520A, ACS8522	Semtech
E4437LF	12.8MHz	ACS1790T, ACS9510, ACS9520T, ACS9522T, ACS9550, ACS9593T, ACS8522BT, ACS8509, ACS8510, ACS8514, ACS8515, ACS8520, ACS8520A, ACS8522	Semtech
E4438LF	20MHz	ZL30152, ZL30155, ZL30157, ZL30159, ZL30160, ZL30165	Microsemi
E4439LF	20MHz	ZL30152, ZL30155, ZL30157, ZL30159, ZL30160, ZL30165	Microsemi
E4441LF	20MHz	ZL30152, ZL30155, ZL30157, ZL30159, ZL30160, ZL30165	Microsemi
E4698LF	12.8MHz	ACS1790T, ACS9510, ACS9520T, ACS9522T, ACS9550, ACS9593T, ACS8522BT, ACS8509, ACS8510, ACS8514, ACS8515, ACS8520, ACS8520A, ACS8522	Semtech

Sales Office Contact Details:

UK: +44 (0)1460 270200
Germany: 0800 1808 443

France: 0800 901 383
USA: +1.760.318.2824

Email: info@iqdfrequencyproducts.com
Web: www.iqdfrequencyproducts.com

Mouser Electronics

Authorized Distributor

Click to View Pricing, Inventory, Delivery & Lifecycle Information:

[IQD Frequency Products:](#)

[LFPTXO000316Bulk](#)