

N-channel 600 V, 7.3 Ω typ., 1 A SuperMESH™ Power MOSFET in an IPAK package

Datasheet - production data

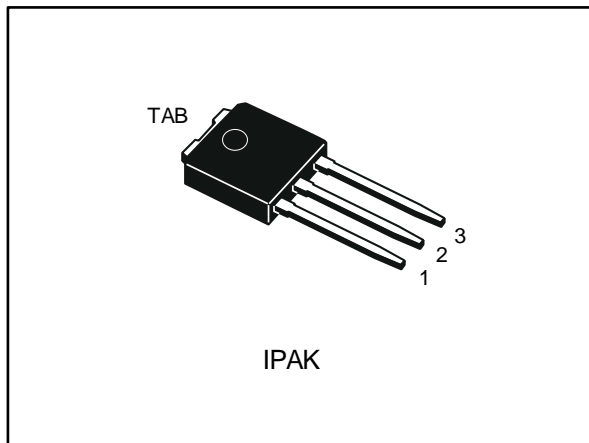
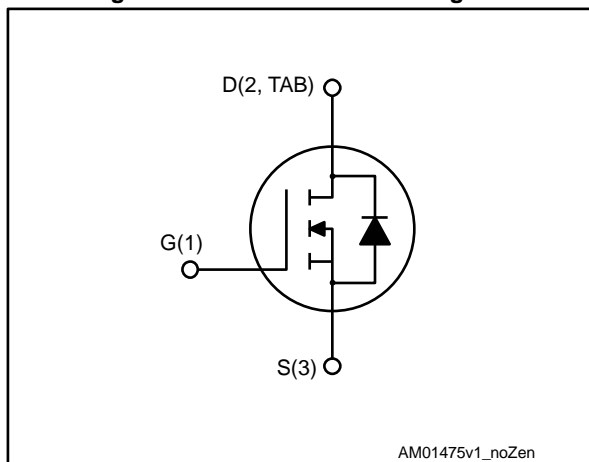

Figure 1: Internal schematic diagram



Features

Order code	V _{DS}	R _{DS(on)} max.	I _D	P _{TOT}
STD1NK60-1	600 V	8.5 Ω	1 A	30 W

- Extremely high dv/dt capability
- ESD improved capability
- 100% avalanche tested
- Gate charge minimized

Applications

- Low power battery chargers
- Switch mode low power supplies (SMPS)
- Low power, ballast, CFL (compact fluorescent lamps)

Description

This high voltage device is an N-channel Power MOSFET developed using the SuperMESH™ technology by STMicroelectronics, an optimization of the well-established PowerMESH™. In addition to a significant reduction in on-resistance, this device is designed to ensure a high level of dv/dt capability for the most demanding applications.

Table 1: Device summary

Order code	Marking	Package	Packing
STD1NK60-1	D1NK60	IPAK	Tube

Contents

1	Electrical ratings	3
2	Electrical characteristics	4
	2.1 Electrical characteristics (curves).....	6
3	Test circuits	9
4	Package information	10
	4.1 IPAK (TO-251) type A package information	10
	4.2 IPAK (TO-251) type C package information	12
5	Revision history	14

1 Electrical ratings

Table 2: Absolute maximum ratings

Symbol	Parameter	Value	Unit
V _{DS}	Drain-source voltage	600	V
V _{DGR}	Drain-gate voltage (R _{GS} = 20 kΩ)	600	V
V _{GS}	Gate-source voltage	±30	V
I _D	Drain current (continuous) at T _C = 25 °C	1.0	A
I _D	Drain current (continuous) at T _C = 100 °C	0.63	A
I _{DM} ⁽¹⁾	Drain current (pulsed)	4	A
P _{TOT}	Total dissipation at T _C = 25 °C	30	W
I _{AR}	Avalanche current, repetitive or not-repetitive (pulse width limited by T _{jmax})	1	A
E _{AS}	Single pulse avalanche energy (starting T _j = 25 °C, I _D = I _{AR} , V _{DD} = 50 V)	25	mJ
dv/dt ⁽²⁾	Peak diode recovery voltage slope	3	V/ns
T _j	Operating junction temperature range	- 55 to 150	°C
T _{stg}	Storage temperature range		

Notes:

⁽¹⁾Pulse width limited by safe operating area.

⁽²⁾I_{SD} ≤ 1.0 A, di/dt ≤ 100 A/μs; V_{DD} ≤ V_{(BR)DSS}, T_J ≤ T_{JMAX}

Table 3: Thermal data

Symbol	Parameter	Value	Unit
R _{thj-case}	Thermal resistance junction-case	4.2	°C/W
R _{thj-amb}	Thermal resistance junction-ambient	100	°C/W

2 Electrical characteristics

$T_C = 25\text{ }^\circ\text{C}$ unless otherwise specified

Table 4: On/off-state

Symbol	Parameter	Test conditions	Min.	Typ.	Max.	Unit
$V_{(BR)DSS}$	Drain-source breakdown voltage	$V_{GS} = 0\text{ V}$, $I_D = 1\text{ mA}$	600			V
I_{DSS}	Zero gate voltage drain current	$V_{GS} = 0\text{ V}$, $V_{DS} = 600\text{ V}$			1	μA
		$V_{GS} = 0\text{ V}$, $V_{DS} = 600\text{ V}$ $T_C = 125\text{ }^\circ\text{C}$ ⁽¹⁾			50	μA
I_{GSS}	Gate body leakage current	$V_{DS}=0\text{ V}$, $V_{GS}=\pm 30\text{ V}$			± 100	nA
$V_{GS(th)}$	Gate threshold voltage	$V_{DS} = V_{GS}$, $I_D = 250\text{ }\mu\text{A}$	2.25	3	3.7	V
$R_{DS(on)}$	Static drain-source on-resistance	$V_{GS} = 10\text{ V}$, $I_D = 0.5\text{ A}$		7.3	8.5	Ω

Notes:

⁽¹⁾Defined by design, not subject to production test.

Table 5: Dynamic

Symbol	Parameter	Test conditions	Min.	Typ.	Max.	Unit
C_{iss}	Input capacitance	$V_{DS} = 25\text{ V}$, $f = 1\text{ MHz}$, $V_{GS} = 0\text{ V}$	-	156	-	pF
C_{oss}	Output capacitance		-	23.5	-	pF
C_{rss}	Reverse transfer capacitance		-	3.8	-	pF
Q_g	Total gate charge	$V_{DD} = 480\text{ V}$, $I_D = 1\text{ A}$ $V_{GS} = 0\text{ to }10\text{ V}$ (see Figure 16: "Test circuit for gate charge behavior")	-	7	-	nC
Q_{gs}	Gate-source charge		-	1.1	-	nC
Q_{gd}	Gate-drain charge		-	3.7	-	nC

Table 6: Switching times

Symbol	Parameter	Test conditions	Min.	Typ.	Max.	Unit
$t_{d(on)}$	Turn-on delay time	$V_{DD} = 300\text{ V}$, $I_D = 0.5\text{ A}$, $R_G = 4.7\text{ }\Omega$ $V_{GS} = 10\text{ V}$ (see Figure 15: "Test circuit for resistive load switching times" and Figure 20: "Switching time waveform")	-	6.5	-	ns
t_r	Rise time		-	5	-	ns
$t_{d(off)}$	Turn-off delay time		-	19	-	ns
t_f	Fall time		-	25	-	ns

Table 7: Source-drain diode

Symbol	Parameter	Test conditions	Min.	Typ.	Max.	Unit
I_{SD}	Source-drain current		-		1	A
$I_{SDM}^{(1)}$	Source-drain current (pulsed)		-		4	A
$V_{SD}^{(2)}$	Forward on voltage	$I_{SD} = 1.0 \text{ A}$, $V_{GS} = 0 \text{ V}$	-		1.6	V
t_{rr}	Reverse recovery time	$I_{SD} = 1.0 \text{ A}$, $di/dt = 100 \text{ A}/\mu\text{s}$, $V_{DD} = 25 \text{ V}$ (see Figure 17: "Test circuit for inductive load switching and diode recovery times")	-	140		ns
Q_{rr}	Reverse recovery charge		-	240		nC
I_{RRM}	Reverse recovery current		-	3.3		A
t_{rr}	Reverse recovery time	$I_{SD} = 1.0 \text{ A}$, $di/dt = 100 \text{ A}/\mu\text{s}$, $V_{DD} = 25 \text{ V}$, $T_j = 150 \text{ }^\circ\text{C}$ (see Figure 17: "Test circuit for inductive load switching and diode recovery times")	-	229		ns
Q_{rr}	Reverse recovery charge		-	377		nC
I_{RRM}	Reverse recovery current		-	3.3		A

Notes:

(1)Pulse width limited by safe operating area

(2)Pulsed: pulse duration = 300 $\mu\text{ s}$, duty cycle 1.5%

2.1 Electrical characteristics (curves)

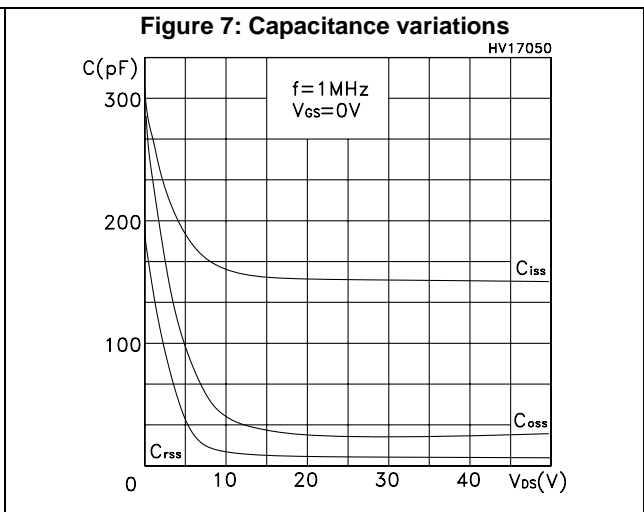
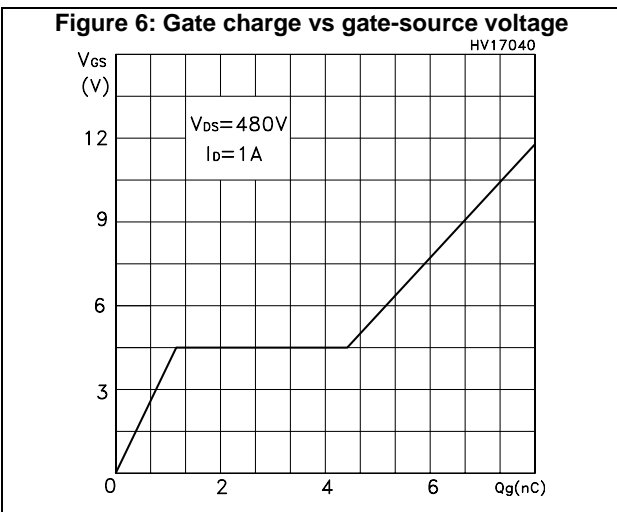
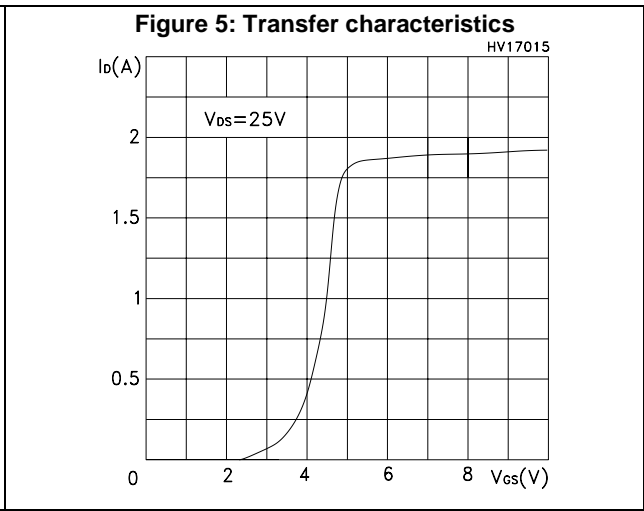
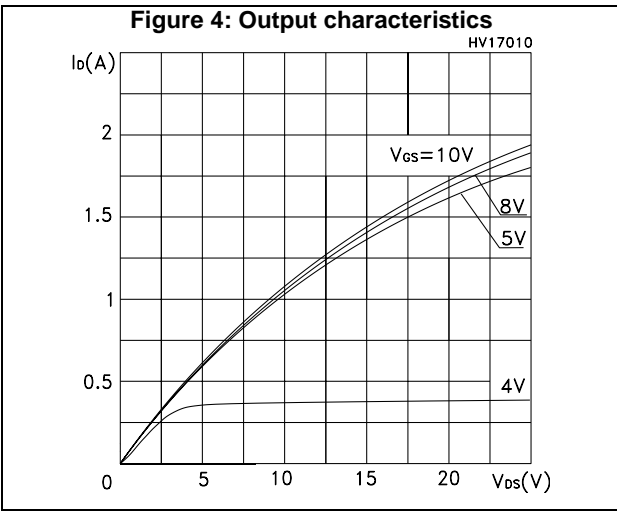
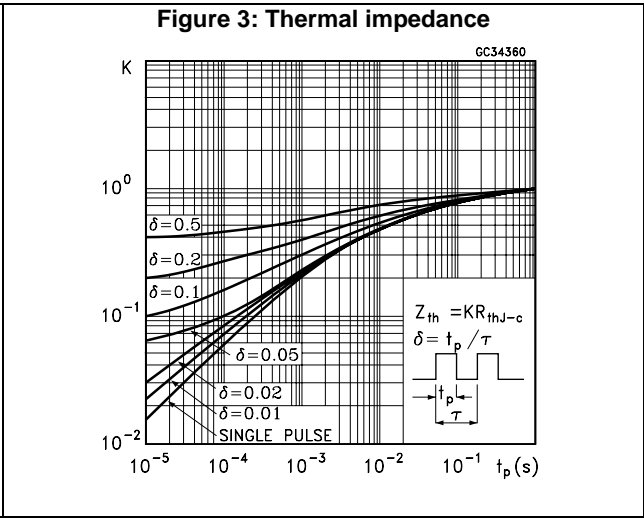
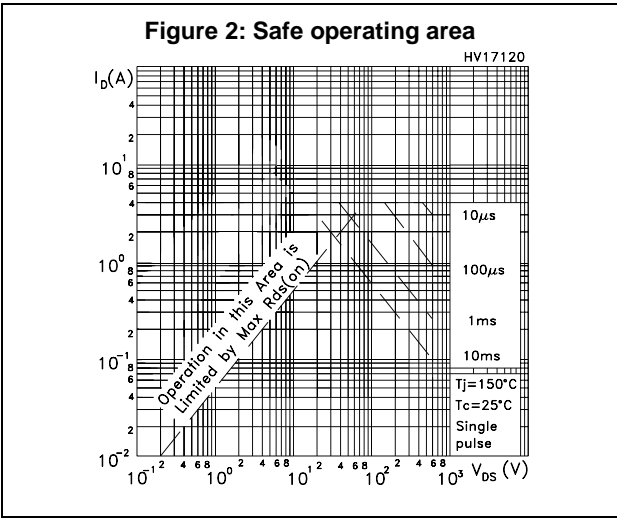

Figure 8: Static drain-source on-resistance

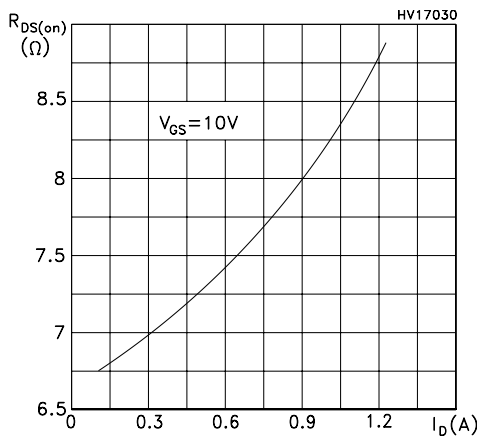

Figure 9: Normalized gate threshold voltage vs temperature

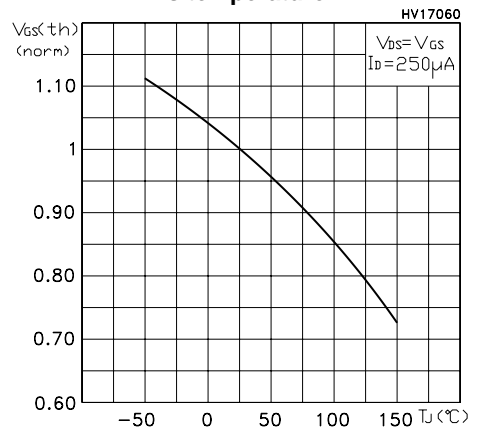

Figure 10: Normalized on-resistance vs temperature

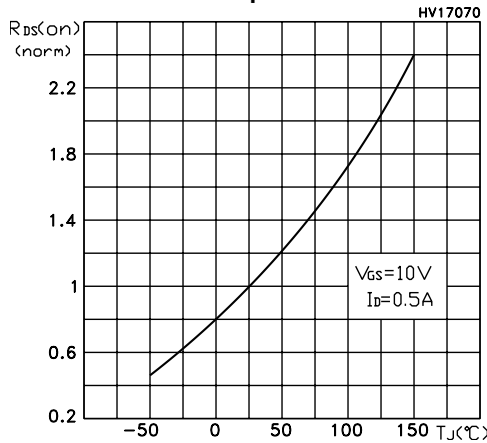

Figure 11: Source-drain forward characteristics

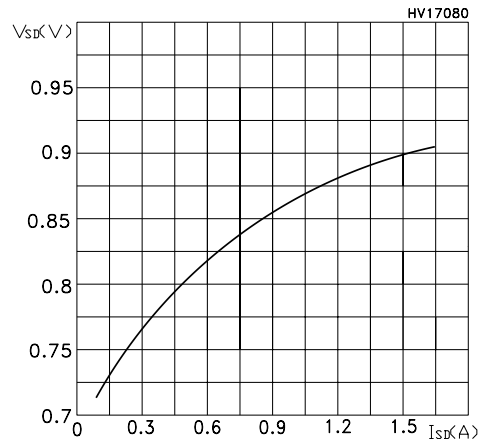

Figure 12: Normalized $V_{(BR)DSS}$ vs temperature

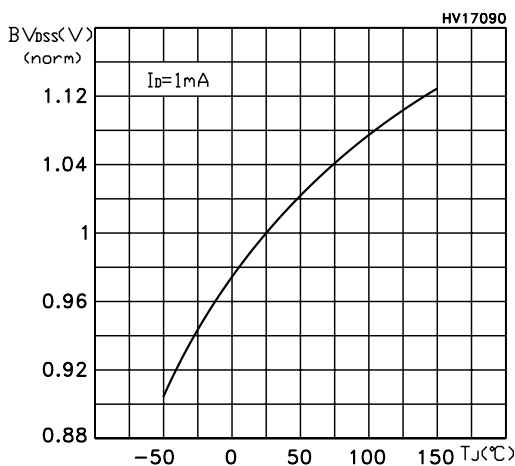

Figure 13: Maximum avalanche energy vs temperature

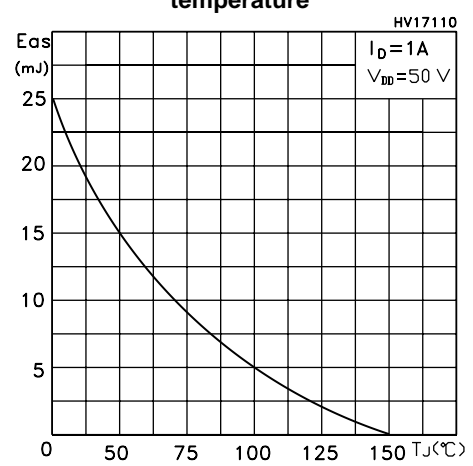
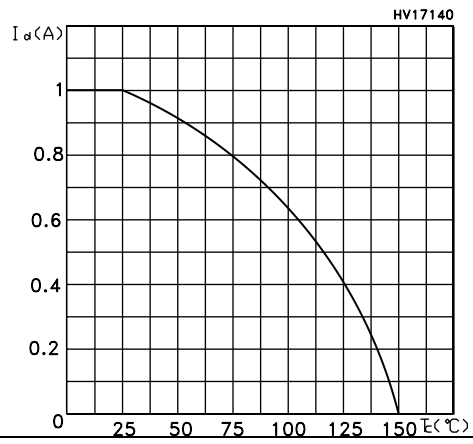
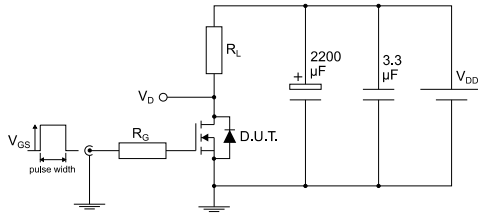

Figure 14: Maximum Id current vs Tc



3 Test circuits

Figure 15: Test circuit for resistive load switching times



AM01468v1

Figure 16: Test circuit for gate charge behavior

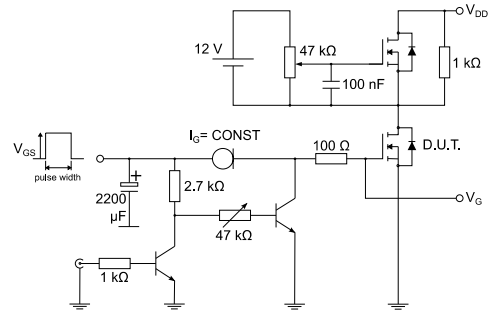

AM01469v1

Figure 17: Test circuit for inductive load switching and diode recovery times

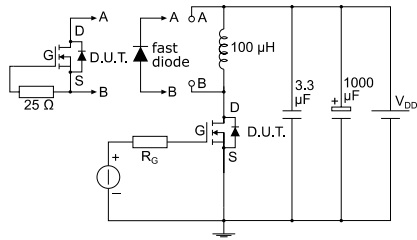

AM01470v1

Figure 18: Unclamped inductive load test circuit

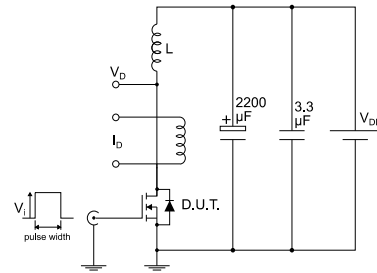

AM01471v1

Figure 19: Unclamped inductive waveform

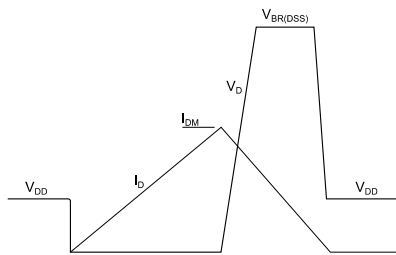

AM01472v1

Figure 20: Switching time waveform

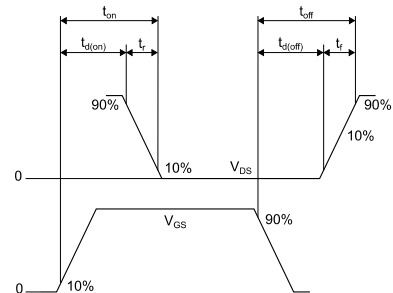

AM01473v1

4 Package information

In order to meet environmental requirements, ST offers these devices in different grades of ECOPACK® packages, depending on their level of environmental compliance. ECOPACK® specifications, grade definitions and product status are available at: www.st.com. ECOPACK® is an ST trademark.

4.1 IPAK (TO-251) type A package information

Figure 21: IPAK (TO-251) type A package outline

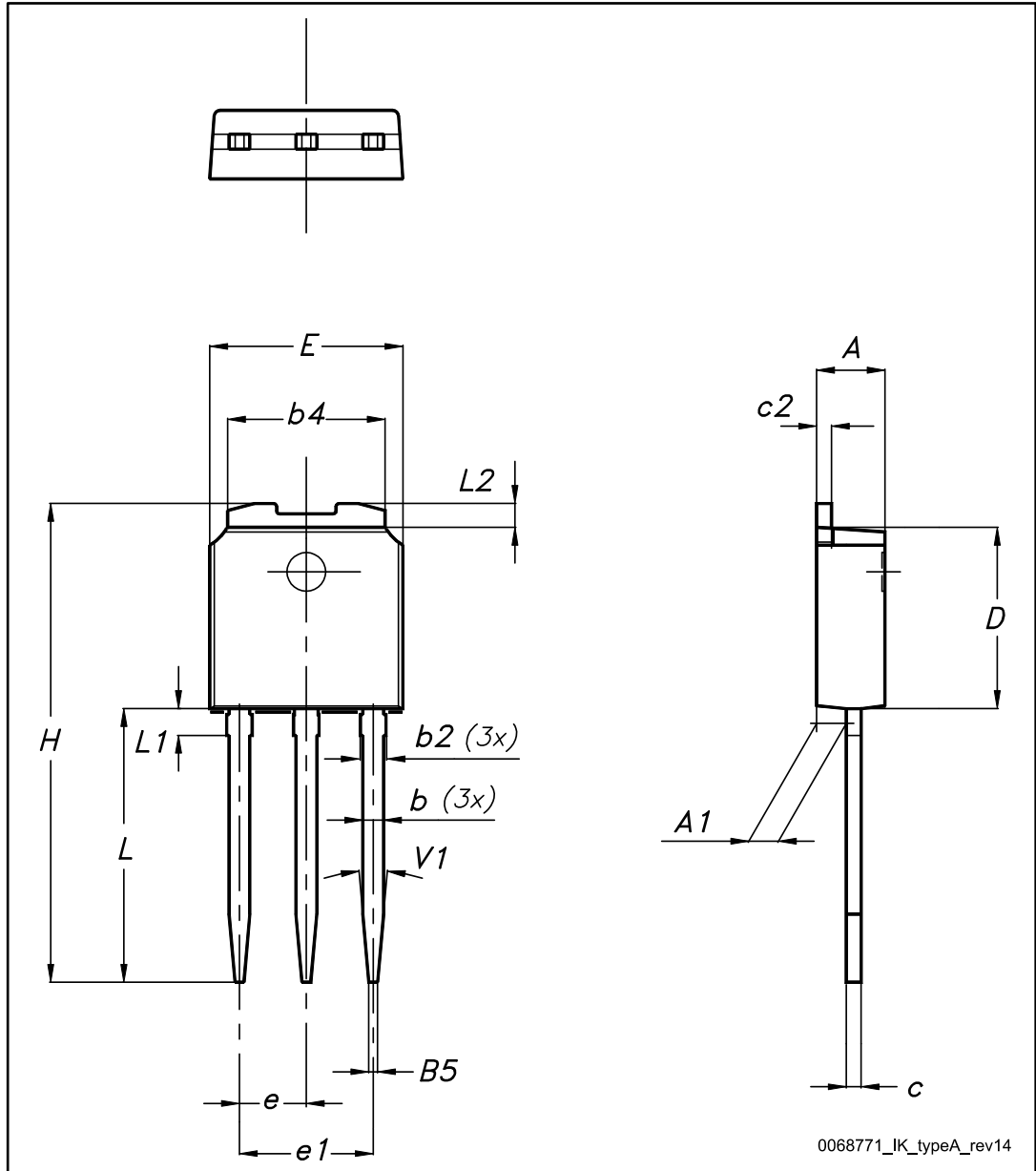

Table 8: IPAK (TO-251) type A package mechanical data

Dim.	mm		
	Min.	Typ.	Max.
A	2.20		2.40
A1	0.90		1.10
b	0.64		0.90
b2			0.95
b4	5.20		5.40
B5		0.30	
c	0.45		0.60
c2	0.48		0.60
D	6.00		6.20
E	6.40		6.60
e		2.28	
e1	4.40		4.60
H		16.10	
L	9.00		9.40
L1	0.80		1.20
L2		0.80	1.00
V1		10°	

Table 9: IPAK (TO-251) type C package mechanical data

Dim.	mm		
	Min.	Typ.	Max.
A	2.20	2.30	2.35
A1	0.90	1.00	1.10
b	0.66		0.79
b2			0.90
b4	5.23	5.33	5.43
c	0.46		0.59
c2	0.46		0.59
D	6.00	6.10	6.20
D1	5.20	5.37	5.55
E	6.50	6.60	6.70
E1	4.60	4.78	4.95
e	2.20	2.25	2.30
e1	4.40	4.50	4.60
H	16.18	16.48	16.78
L	9.00	9.30	9.60
L1	0.90	1.00	1.20
L2	0.90	1.08	1.25
$\theta 1$	3°	5°	7°
$\theta 2$	1°	3°	5°

5 Revision history

Table 10: Document revision history

Date	Revision	Changes
09-Feb-2017	1	First release.

IMPORTANT NOTICE – PLEASE READ CAREFULLY

STMicroelectronics NV and its subsidiaries ("ST") reserve the right to make changes, corrections, enhancements, modifications, and improvements to ST products and/or to this document at any time without notice. Purchasers should obtain the latest relevant information on ST products before placing orders. ST products are sold pursuant to ST's terms and conditions of sale in place at the time of order acknowledgement.

Purchasers are solely responsible for the choice, selection, and use of ST products and ST assumes no liability for application assistance or the design of Purchasers' products.

No license, express or implied, to any intellectual property right is granted by ST herein.

Resale of ST products with provisions different from the information set forth herein shall void any warranty granted by ST for such product.

ST and the ST logo are trademarks of ST. All other product or service names are the property of their respective owners.

Information in this document supersedes and replaces information previously supplied in any prior versions of this document.

© 2017 STMicroelectronics – All rights reserved

Mouser Electronics

Authorized Distributor

Click to View Pricing, Inventory, Delivery & Lifecycle Information:

[STMicroelectronics:](#)

[STD1NK60-1](#)