

2.4 GHz WiFi Antenna

10 x 3.2 x 4.0 mm Ceramic Chip Antenna (On Ground type, Top surface ground removal area 10.80 x 6.25 mm).
Pulse Part Number: W3001

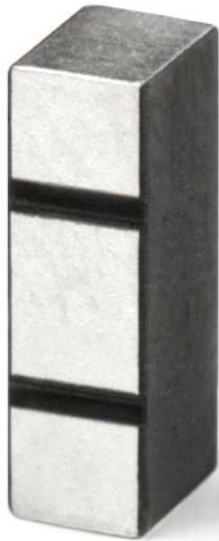

Features

- Omni directional radiation (Azimuthal plane)
- Low profile
- Compact size W x L x H (10 x 3.2 x 4 mm)
- Low weight (600 mg)
- Lead free materials
- Fully SMD compatible
- Lead free soldering compatible
- Tape and reel packing
- RoHS compliant product

Applications

- Bluetooth
- 2.4 GHz WLAN
- 2.4 GHz ISM Band System

Electrical specifications @ +25 °C

Note: Electrical characteristics depend on test board (GP) size and antenna positioning on GP and Ground Clearance area size.

WiFi 2.4 GHz

Typical performance

(Test board size 80 x 37 mm, PWB top surface ground removal area 10.80 x 6.25 mm, position 1 on PWB)

Frequency Range [MHz]	Max Gain [dBi]	Efficiency [%] / [dB]	Return loss min. [dB]	Impedance [Ω]	Operating Temperature [° C]
2400 – 2483.5	1.5 (Peak) 0.5 (Band edges)	75 /-1.25 (Peak) 60/-2.25 (Band edges)	-6	50	-45 to +85

Pulse Finland Oy

Takatie 6
90440 Kempele, Finland
Tel: +358 207 935 500
Fax: +358 207 935 501

www.pulseeng.com/antennas



2.4 GHz WiFi Antenna

10 x 3.2 x 4.0 mm Ceramic Chip Antenna (On Ground type, Top surface ground removal area 10.80 x 6.25 mm).
Pulse Part Number: W3001

Terminal Configuration and Dimensions

On Ground type, Top surface ground removal area 10.80 x 6.25 mm

Antenna features

No.	Terminal name	Terminal Dimensions
1	Feed / GND	1.5 x 2.75 mm
2	Feed / GND	1.5 x 2.75 mm

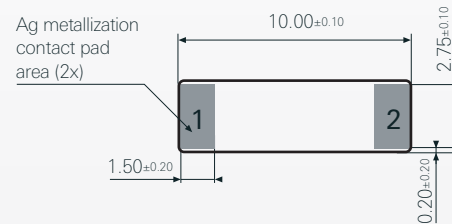

Antenna is symmetrical.

Either of terminals 1 or 2 can be feed / GND

Antenna PWB Layout Specifications

On Ground type, Top surface ground removal area 10.80 x 6.25 mm

Matching and tuning component values depend on application and surrounding mechanics / materials.

Feed line should be designed to match 50 Ω characteristic impedance, depending on PWB material and thickness.

Recommended test board layout for electrical characteristic measurement, test board outline size 80 x 37 mm.

PWB layout for W3001 Antenna

Note: All dimensions are in metric system.

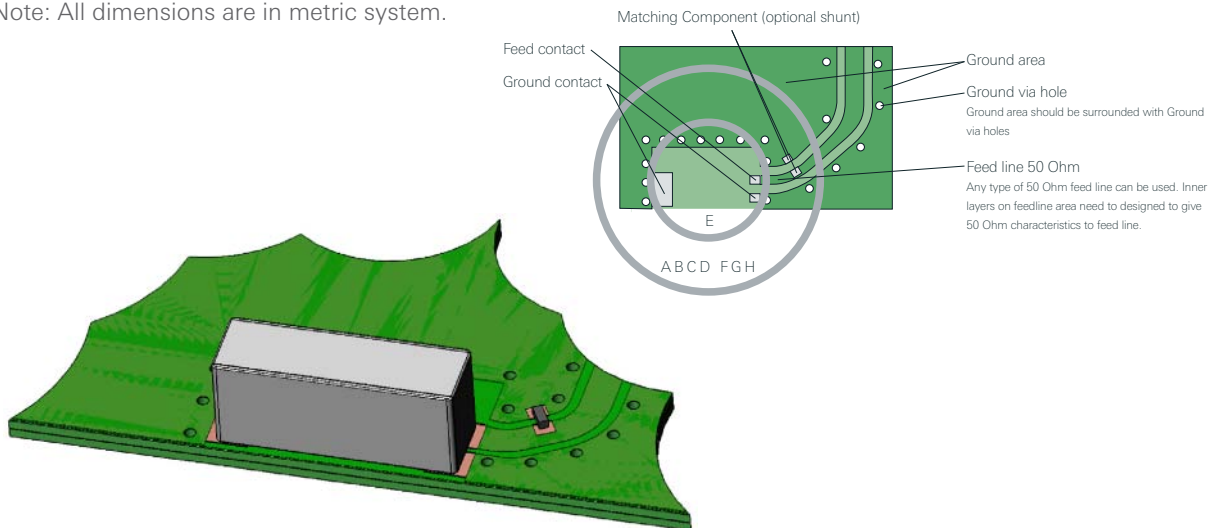

2.4 GHz WiFi Antenna

10 x 3.2 x 4.0 mm Ceramic Chip Antenna (0n Ground type, Top surface ground removal area 10.80 x 6.25 mm).
Pulse Part Number: W3001

Metallization layers for W3001 Antenna

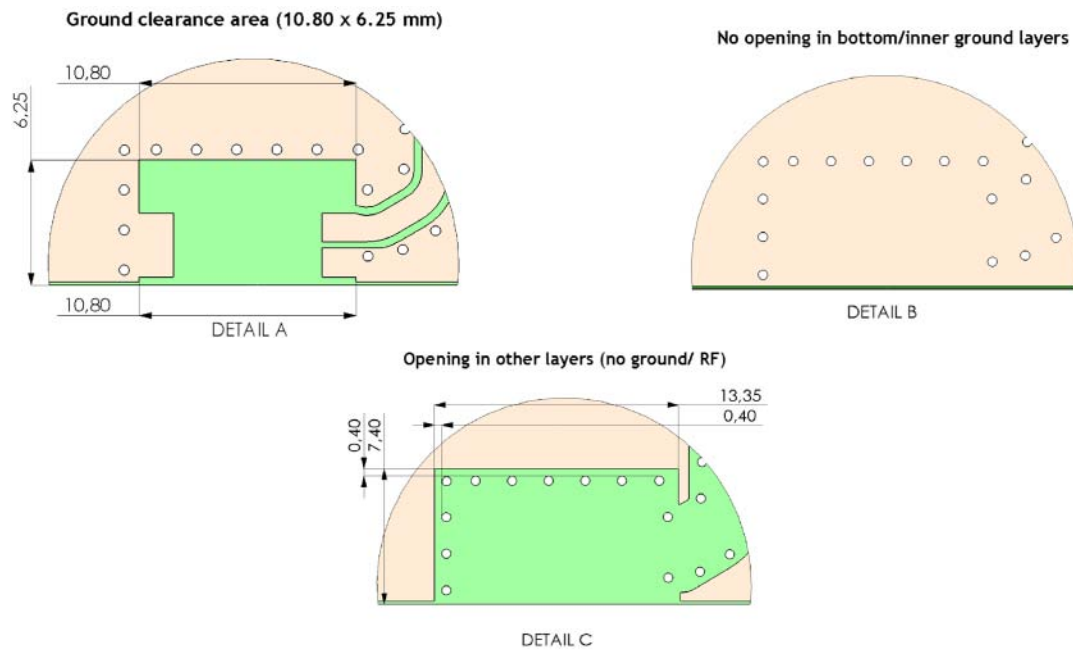

PWB pad dimensions and antenna position for W3001 Antenna

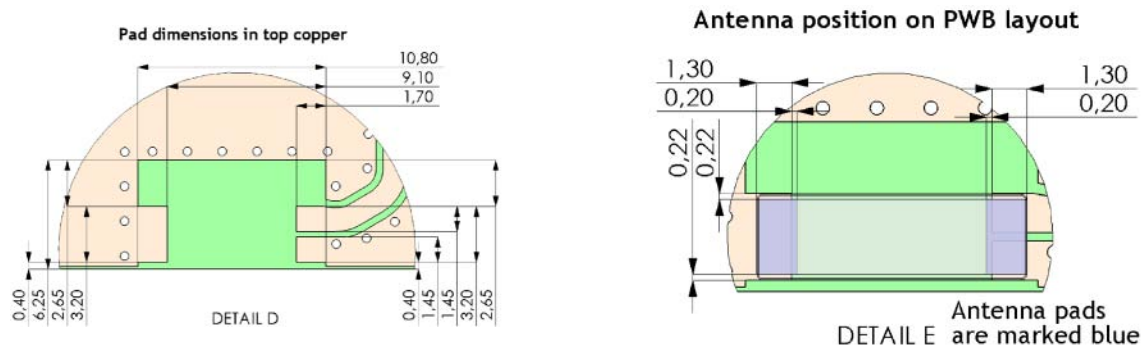

2.4 GHz WiFi Antenna

10 x 3.2 x 4.0 mm Ceramic Chip Antenna (0n Ground type, Top surface ground removal area 10.80 x 6.25 mm).
Pulse Part Number: W3001

Typical ground via hole placement in PWB layout for W3001 Antenna

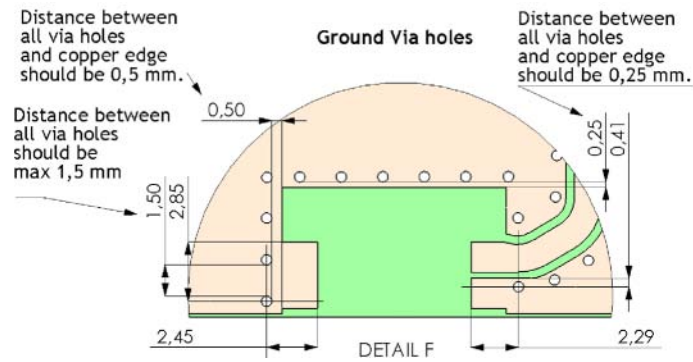

Solder resist opening and Paste stencil recommendation for W3001 Antenna

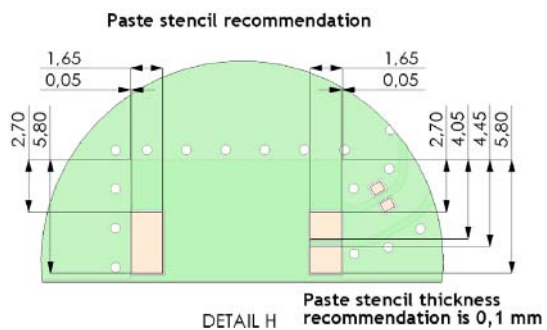
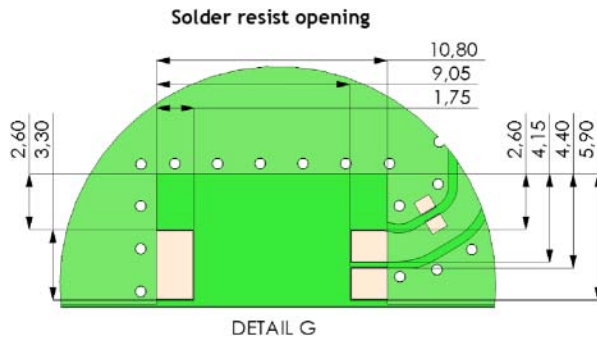

2.4 GHz WiFi Antenna

10 x 3.2 x 4.0 mm Ceramic Chip Antenna (On Ground type, Top surface ground removal area 10.80 x 6.25 mm).
Pulse Part Number: W3001

Recommended antenna position on PWB for W3001 Antenna

Our test PWB size is 37 x 80 mm, other sized boards can be used depending on customer device size (minimum 35 x 35 mm).

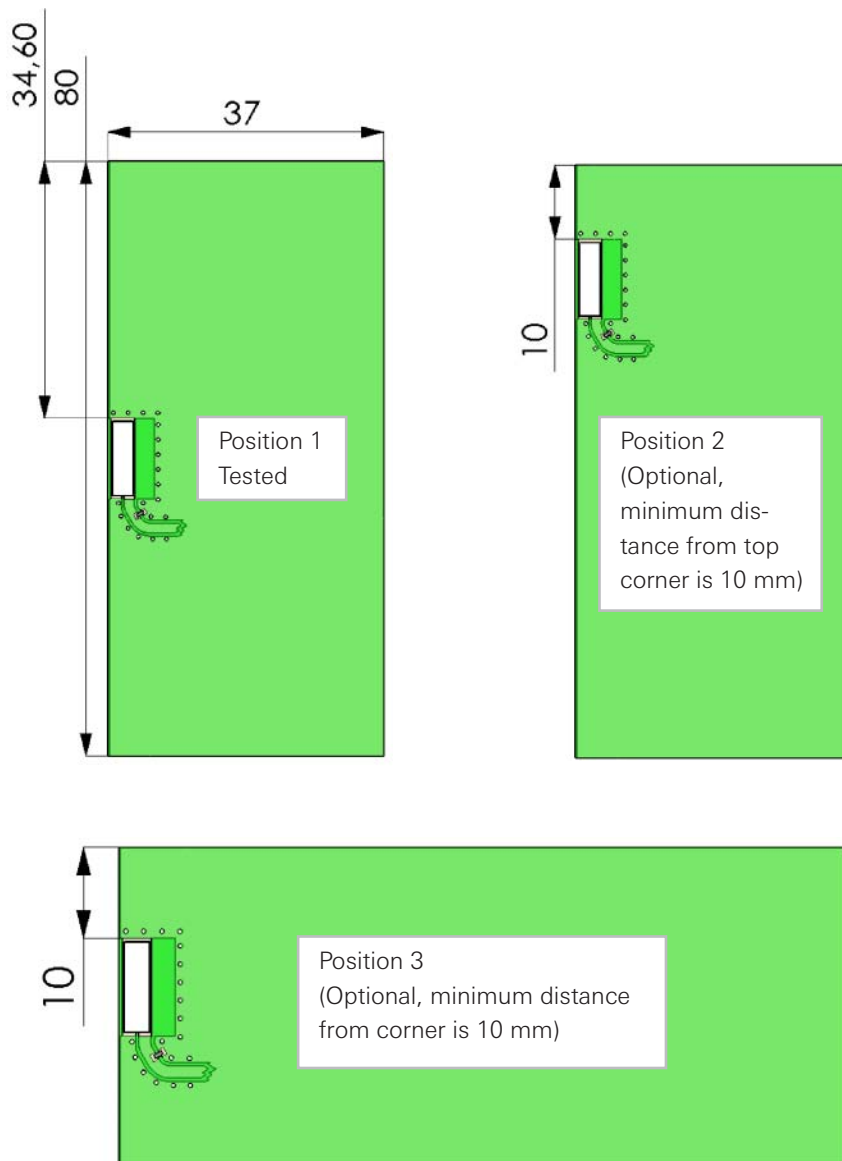

2.4 GHz WiFi Antenna

10 x 3.2 x 4.0 mm Ceramic Chip Antenna (On Ground type, Top surface ground removal area 10.80 x 6.25 mm).
Pulse Part Number: W3001

Typical Electrical Characteristics (T=25 °C)

Measured on the 80 x 37 mm test board with matching circuit (1.2 pF shunt matching capacitor on feed). Measured in antenna position 1 on PWB layout, see previous page.

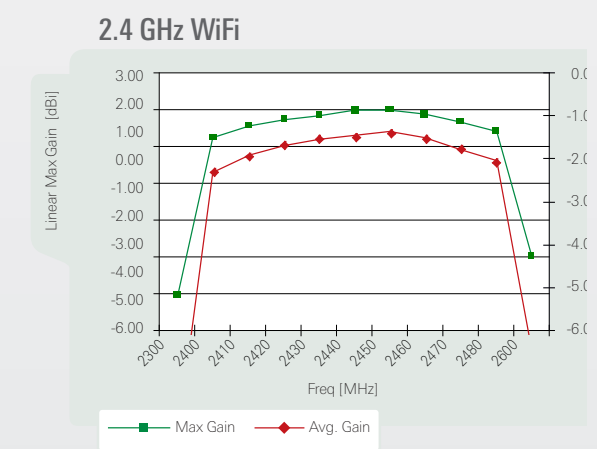
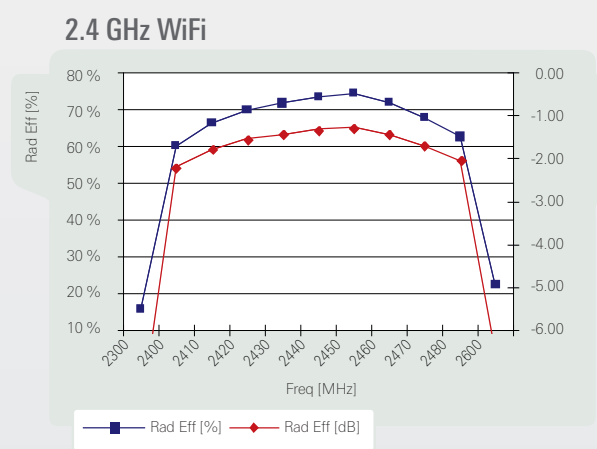
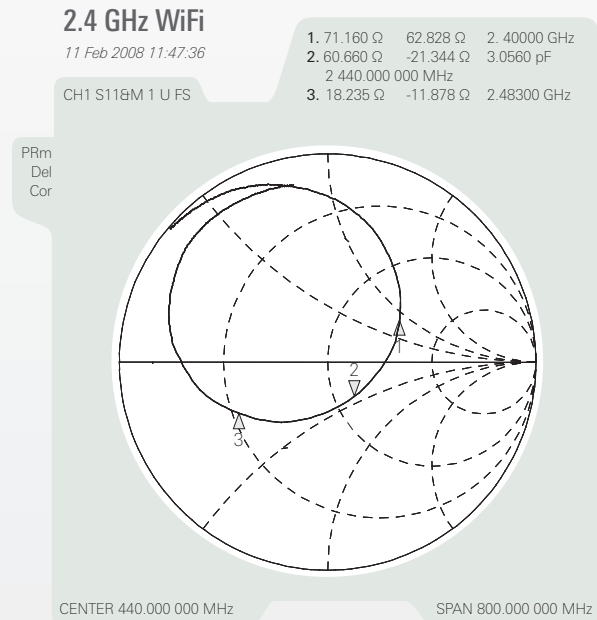
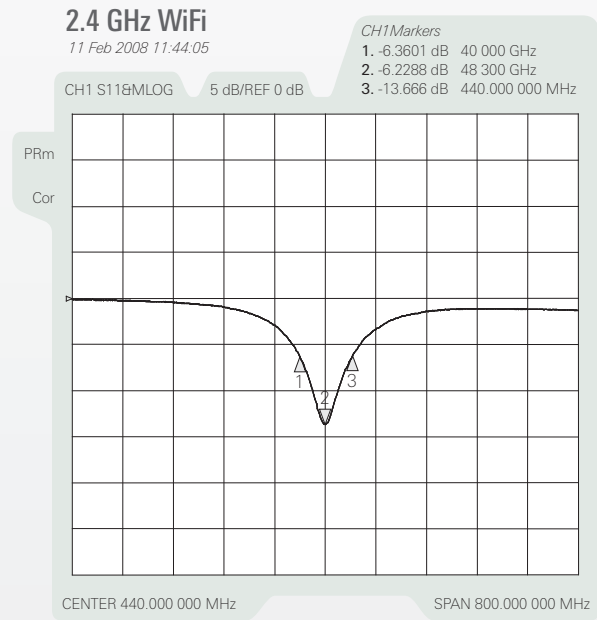

2.4 GHz WiFi Antenna

10 x 3.2 x 4.0 mm Ceramic Chip Antenna (0n Ground type, Top surface ground removal area 10.80 x 6.25 mm).
Pulse Part Number: W3001

Typical Free Space Radiation Patterns

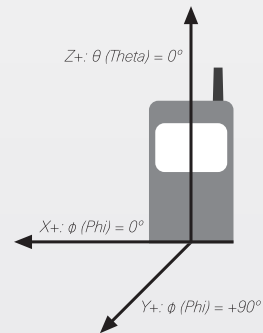
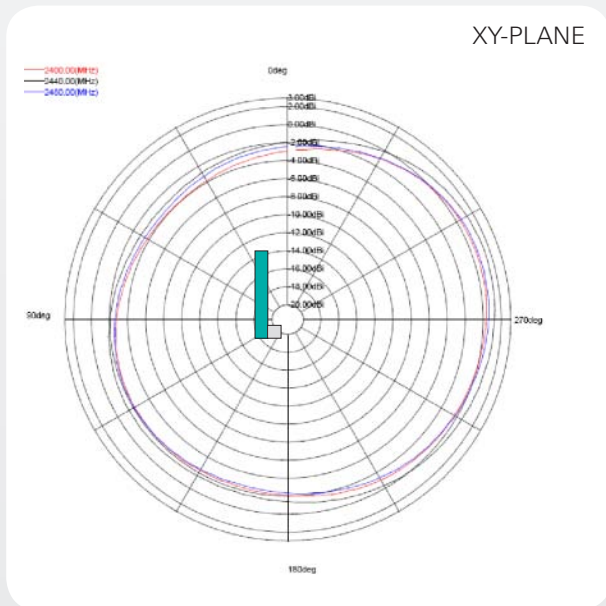
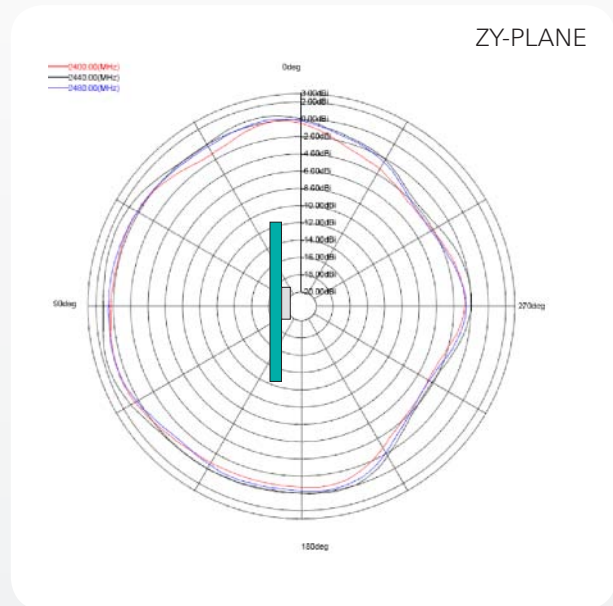
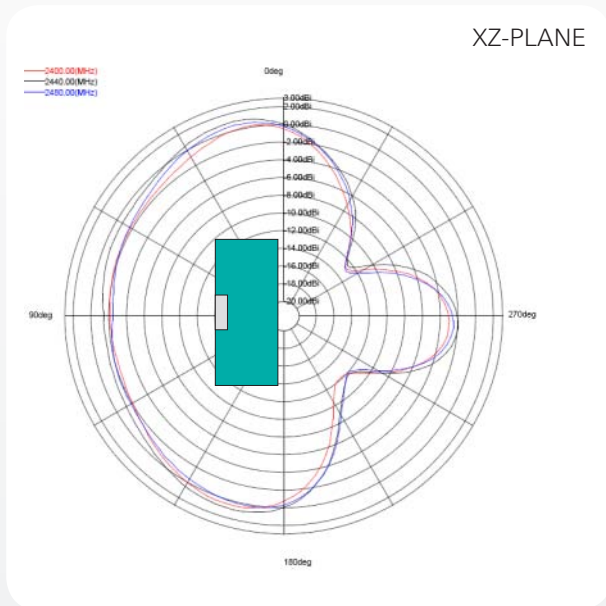

Pulse Finland Oy

Takatie 6
90440 Kempele, Finland
Tel: +358 207 935 500
Fax: +358 207 935 501

www.pulseeng.com/antennas



2.4 GHz WiFi Antenna

10 x 3.2 x 4.0 mm Ceramic Chip Antenna (0n Ground type, Top surface ground removal area 10.80 x 6.25 mm).
Pulse Part Number: W3001

Packing

Tape and reel packing is used. Carrier tape, reel and box dimensions are presented in following pictures.

Carrier Tape

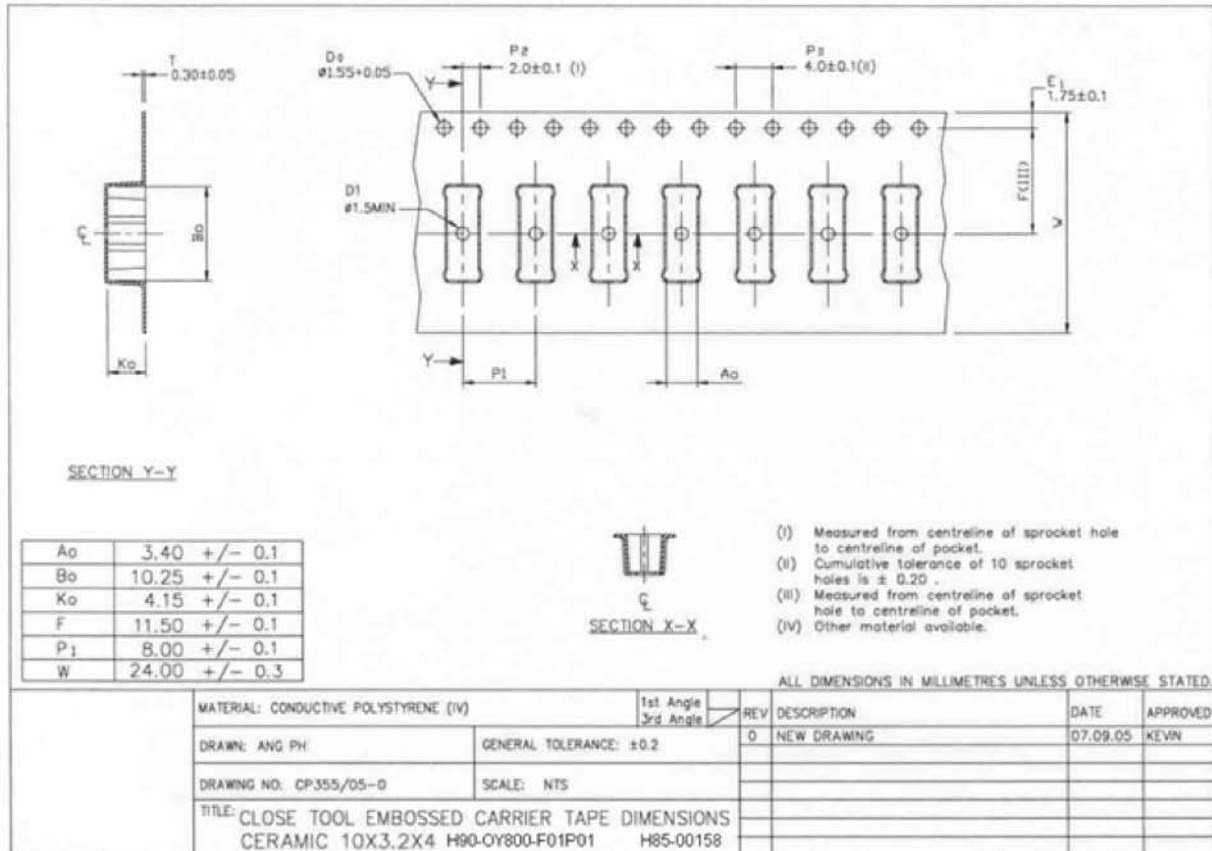

Block Orientation

Antenna soldering pads facing down to the bottom of the carrier tape.

Top View of the Carrier Tape



Top Surface of the Antenna

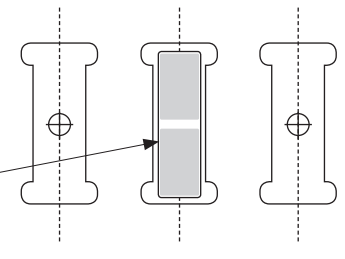

2.4 GHz WiFi Antenna

10 x 3.2 x 4.0 mm Ceramic Chip Antenna (On Ground type, Top surface ground removal area 10.80 x 6.25 mm).
 Pulse Part Number: W3001

Packing Form

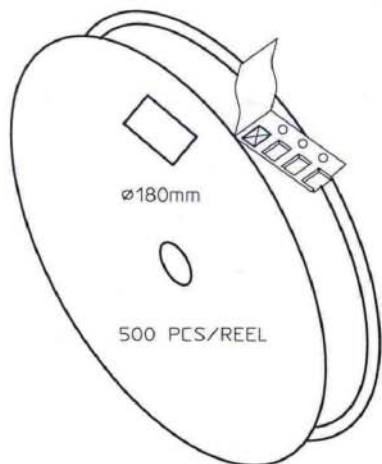

CARRIER TAPE H85-00158
 width=24,00 depth=4.15
 COVER TAPE H85-00159
 width=21.20

LENGTH OF TAPE:

- Leader section: min 350 mm before component section
- Trailer section: min 40 mm after component section.

Empty part cavities at leader and trailer section of the tape must be sealed with top cover tape.

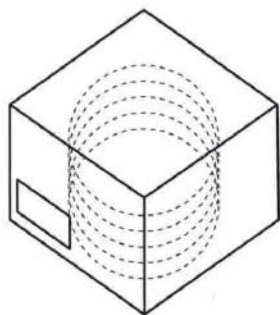

- BOX H85-00128 (182x182x125) 1 pcs
- LABEL 1 pcs/BOX
- REEL H85-00160 (D180, W28) 4 pcs
- REEL LABEL 1 pcs/REEL

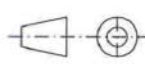
MATERIAL					
HANDLINGS					
		RATIO	DRWN	160107 PeHa	H
			DGNER		G
PRODUCT H90-OY800-F01P01			CHKD		F
			APPRD		E
			APPRD BY		D
					C
					B
DENOMINATION PACKING FORM					A
			VERSION		MOD/DATE/NAME

Pulse Finland Oy

Takatie 6
 90440 Kempele, Finland
 Tel: +358 207 935 500
 Fax: +358 207 935 501
www.pulseeng.com/antennas



2.4 GHz WiFi Antenna

10 x 3.2 x 4.0 mm Ceramic Chip Antenna (0n Ground type, Top surface ground removal area 10.80 x 6.25 mm).
Pulse Part Number: W3001

Mechanical Outline

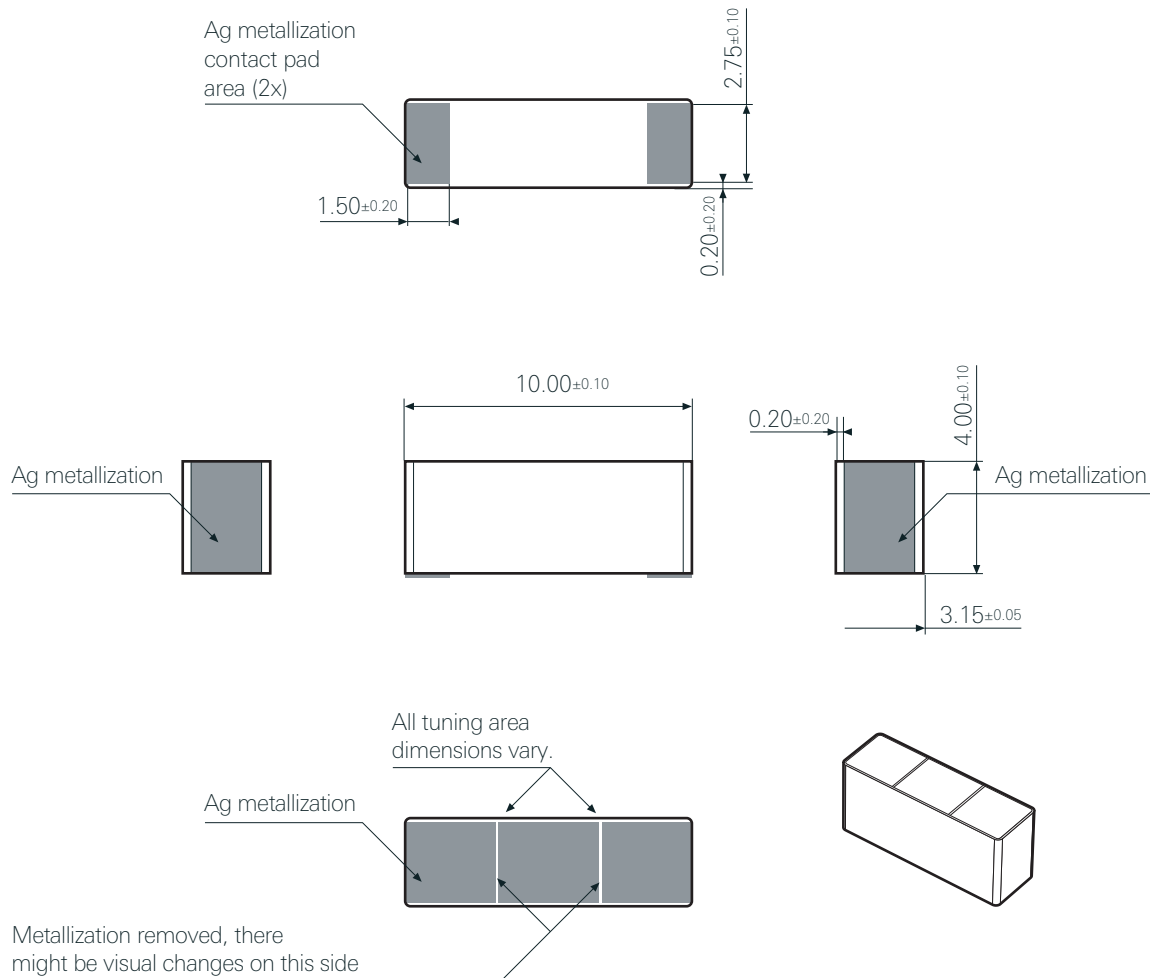

Pulse Finland Oy

Takatie 6
90440 Kempele, Finland
Tel: +358 207 935 500
Fax: +358 207 935 501
www.pulseeng.com/antennas

Mouser Electronics

Authorized Distributor

Click to View Pricing, Inventory, Delivery & Lifecycle Information:

[Pulse:](#)

[W3001](#)