

THIS DRAWING IS UNPUBLISHED. RELEASED FOR PUBLICATION 20
 © COPYRIGHT 20 BY - ALL RIGHTS RESERVED.

LOC		DIST		REVISIONS			
P	LTR	DESCRIPTION	DATE	DWN	APVD		
	P	REVISED PER ECO-11-004820	11MAR2011	RK	HMR		

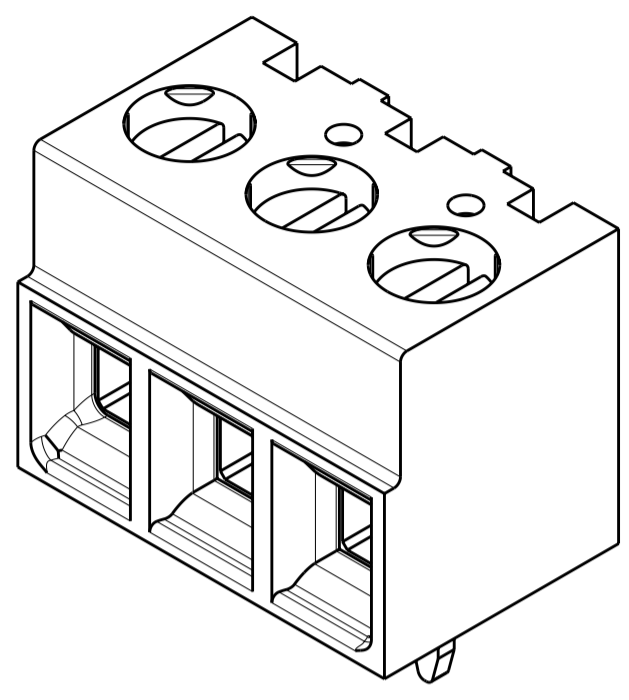
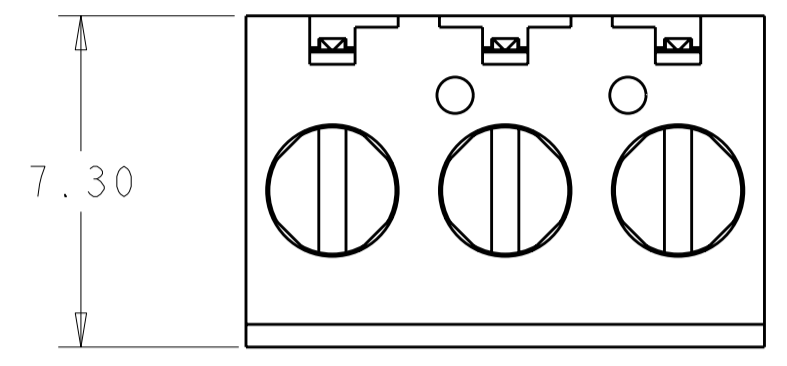

1776113-3 AS SHOWN

- ⚠ MATERIALS AND FINISH:
 HOUSING: HIGH TEMPERATURE POLYAMIDE, UL 94V-0 RATED,
 COLOR: BLACK.
 TERMINAL: COPPER ALLOY, TIN PLATED.
 CLAMP: COPPER ALLOY, NICKEL PLATED.
 CLAMPING SCREW: COPPER ALLOY, NICKEL PLATED.
- WIRE SIZE RANGE: 16-28 AWG.
 - CURRENT RATING: 12A, 150V
 OPERATING TEMPERATURE: -40°C TO +110°C
 - SUITABLE FOR 2.4mm MAX PCB BOARD THICKNESS.

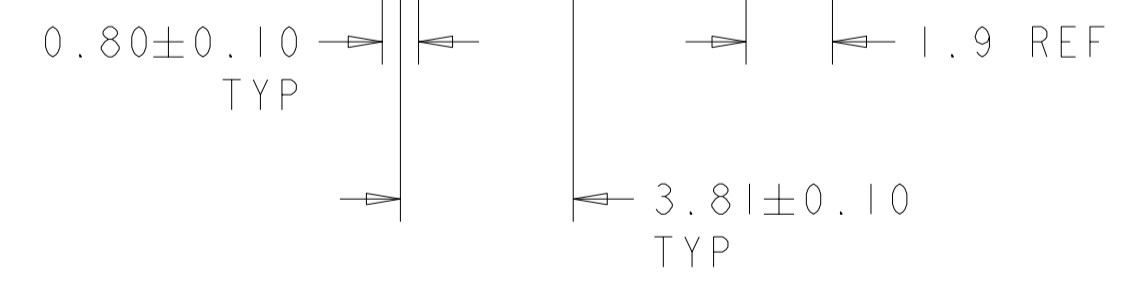
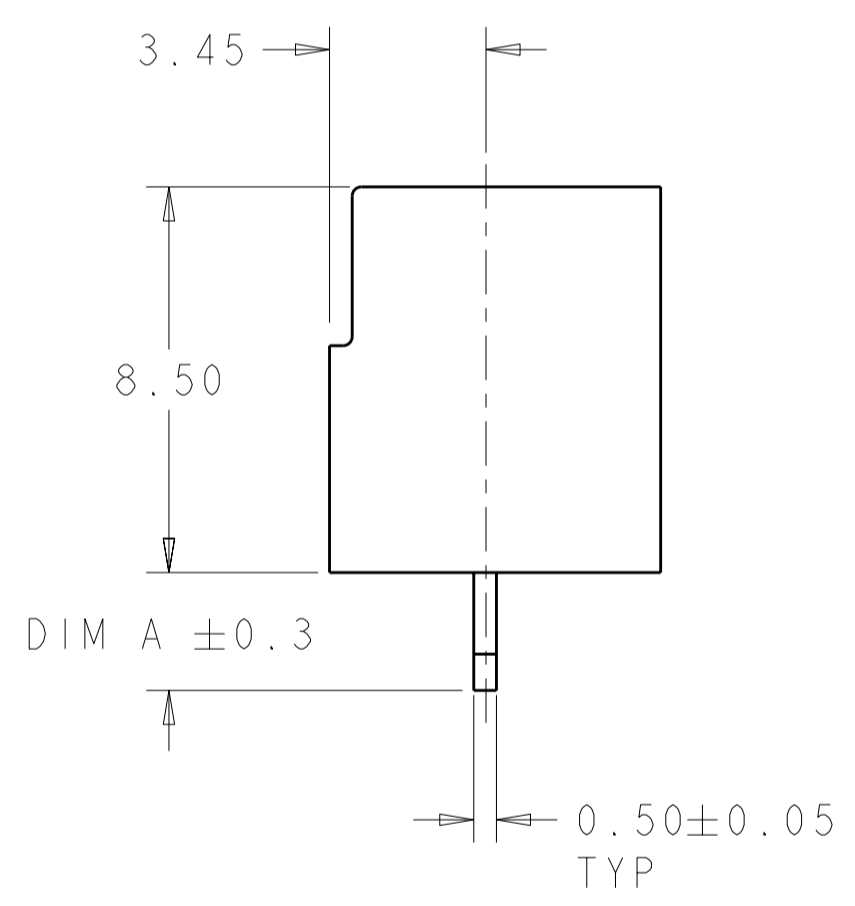
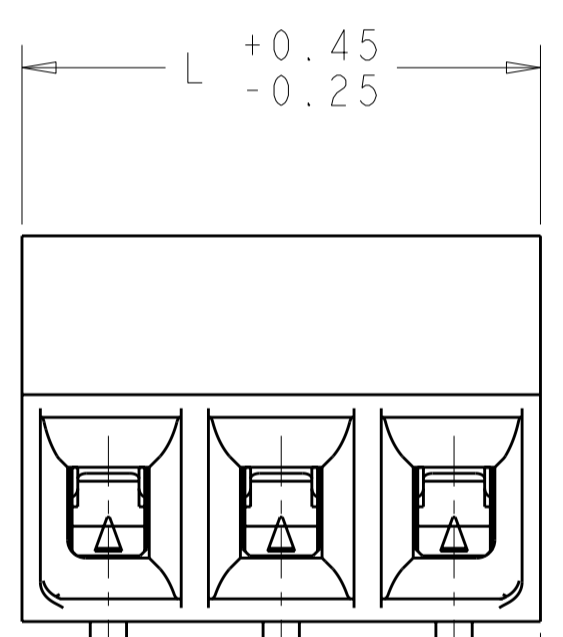

3.5	45.72	12	3-1776113-2
	41.91	11	3-1776113-1
	38.10	10	3-1776113-0
	34.29	9	2-1776113-9
	30.48	8	2-1776113-8
	26.67	7	2-1776113-7
	22.86	6	2-1776113-6
	19.05	5	2-1776113-5
	15.24	4	2-1776113-4
	11.43	3	2-1776113-3
	7.62	2	2-1776113-2
	2.6	45.72	12
41.91		11	1-1776113-1
38.10		10	1-1776113-0
34.29		9	1776113-9
30.48		8	1776113-8
26.67		7	1776113-7
22.86		6	1776113-6
19.05		5	1776113-5
15.24		4	1776113-4
11.43		3	1776113-3
7.62		2	1776113-2
DIM A		L	NO OF POSN

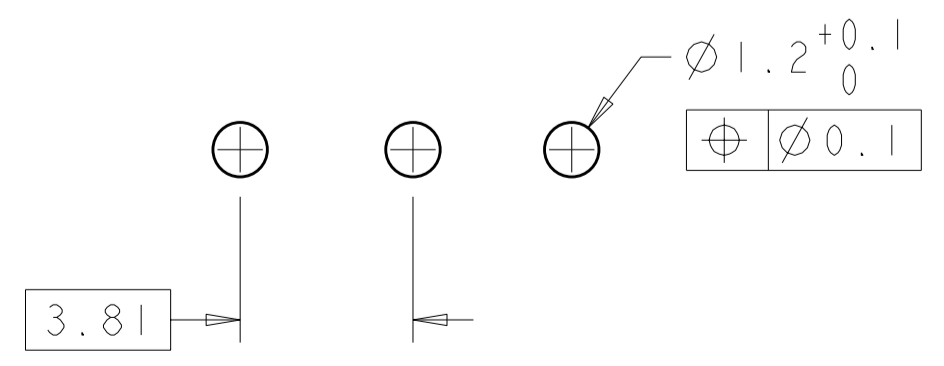

RECOMMENDED PC BOARD LAYOUT

THIS DRAWING IS A CONTROLLED DOCUMENT. DWN S.WELDON 02JUN2005
 CHK C.RICHARD 02JUN2005
 APVD C.RICHARD 02JUN2005

STE TE Connectivity

NAME: TERMINAL BLOCK, PCB MOUNT, STRAIGHT, 8.5mm PROFILE, SIDE WIRE ENTRY, 3.81mm PITCH

DIMENSIONS: mm	TOLERANCES UNLESS OTHERWISE SPECIFIED:	PRODUCT SPEC	SIZE	CAGE CODE	DRAWING NO	RESTRICTED TO
	0 PLC ±		A2	00779	C-1776113	
	1 PLC ±0.3	APPLICATION SPEC				
	2 PLC ±0.25					
	3 PLC ±0.000	WEIGHT				
	4 PLC ±0.000					
MATERIAL	FINISH	CUSTOMER DRAWING	SCALE	SHEET	OF	REV
			6:1	1	1	P

Mouser Electronics

Authorized Distributor

Click to View Pricing, Inventory, Delivery & Lifecycle Information:

[TE Connectivity:](#)

[1776113-5](#)