

### Features

- Low power consumption
- General purpose leads
- Bulk, Available on tape and reel
- Fast response time
- High photo sensitivity
- Small junction capacitance
- Compliance with EU REACH
- The product itself remain within RoHS compliant version

### Applications

- Infrared application system
- Optoelectronic automatic control system

- Optoelectronic switch
- Printer
- Counters and sorters
- Encoders
- Floppy disk drive
- Video camera, tape and card readers
- Position sensors

### Description

- The INL-3ANPT30 is a high speed and high sensitive silicon NPN phototransistor in a standard 3mm epoxy package.
- Due to its black epoxy, the device is matched to visible light and infrared radiation.

### Package Dimensions in mm

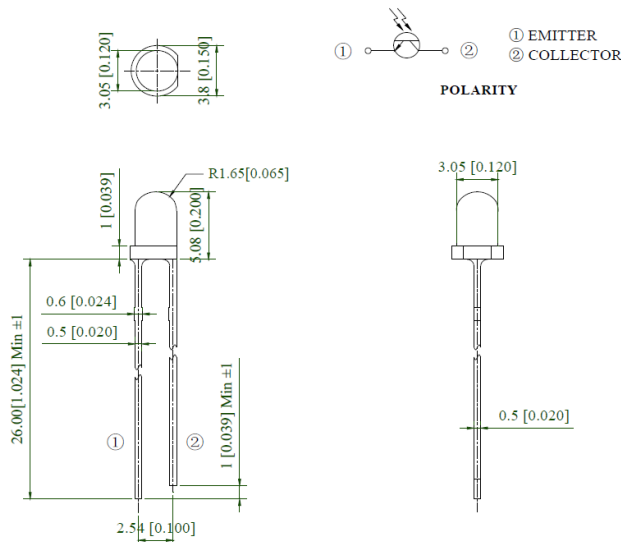

#### Notes:

1. All dimensions are in millimeters (inches).
2. Tolerance is  $\pm 0.25$  mm (.010 ") unless otherwise noted.

**Figure 1. INL-3ANPT30 Package Dimensions**

### Absolute Maximum Rating at 25°C

Symbol	Parameters	Ratings	Units	Notes
BV <sub>CEO</sub>	Collector-Emitter Breakdown Voltage	30	V	1
BV <sub>ECO</sub>	Emitter-Collector Breakdown Voltage	5	V	2
I <sub>c</sub>	Collector Current	20	mA	
T <sub>opr</sub>	Operating Temperature	-40~+80	°C	
T <sub>stg</sub>	Storage Temperature	-40~+85	°C	
T <sub>sol</sub>	Soldering Temperature	260	°C	3
P <sub>D</sub>	Total Power Dissipation	75	mW	

### Notes

1. Test conditions: I<sub>c</sub>=100μA, E<sub>e</sub>=0mW/cm<sup>2</sup>.
2. Test conditions: I<sub>E</sub>=100μA, E<sub>e</sub>=0mW/cm<sup>2</sup>.
3. Soldering time ≤ 5 seconds.

### Electro-Optical Characteristics

Symbol	Parameters	Test conditions	Min	Typ	Max	Units
λ <sub>D</sub>	Rang of Spectral Bandwidth	---	400	-	1100	nm
λ <sub>P</sub>	Wavelength of Peak Sensitivity	---	-	940		nm
BV <sub>CEO</sub>	Collector-Emitter Breakdown Voltage	I <sub>c</sub> =100μA E <sub>e</sub> =0mW/cm <sup>2</sup>	30	-	-	V
BV <sub>ECO</sub>	Emitter-Collector Breakdown Voltage	I <sub>E</sub> =100μA E <sub>e</sub> =0mW/cm <sup>2</sup>	5	-	-	V
V <sub>CE(sat)</sub>	Collector-Emitter Saturation Voltage	I <sub>c</sub> =0.7mA E <sub>e</sub> =1mW/cm <sup>2</sup>	-	-	0.4	V
I <sub>CEO</sub>	Collector Dark Current	V <sub>CE</sub> =20V E <sub>e</sub> =0mW/cm <sup>2</sup>	-	-	100	nA
I <sub>C(ON)</sub>	On State Collector Current	E <sub>e</sub> =1mW/cm <sup>2</sup> λ <sub>P</sub> =940nm, V <sub>CE</sub> =5V	0.7	2.5	-	mA
t <sub>r</sub>	Rise Time	V <sub>CE</sub> =5V, I <sub>c</sub> =1mA	-	15	-	uS
t <sub>f</sub>	Fall Time	RL=1000Ω	-	15	-	uS

### ESD Precaution

ATTENTION: Electrostatic Discharge (ESD) protection



The symbol above denotes that ESD precaution is needed. ESD protection for GaP and AlGaAs based chips is necessary even though they are relatively safe in the presence of low static-electric discharge. Parts built with AlInGaP, GaN, or/and InGaN based chips are STATIC SENSITIVE devices. ESD precaution must be taken during design and assembly.

If manual work or processing is needed, please ensure the device is adequately protected from ESD during the process.

Please be advised that normal static precautions should be taken in the handling and assembly of this device to prevent damage or degradation which may be induced by electrostatic discharge (ESD).

## Typical Characteristic Curves

Spectral Sensitivity

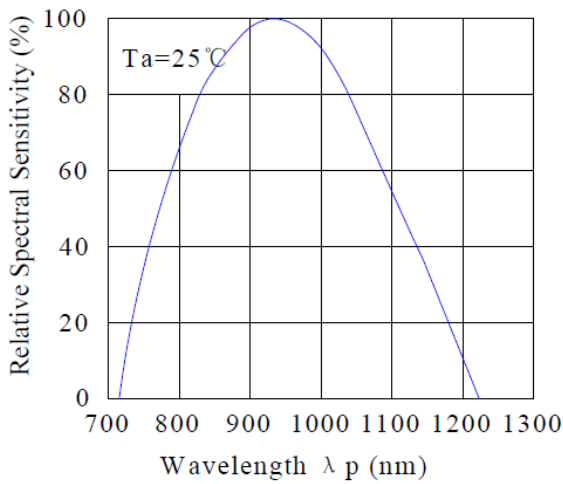

Collector Current & Irradiance

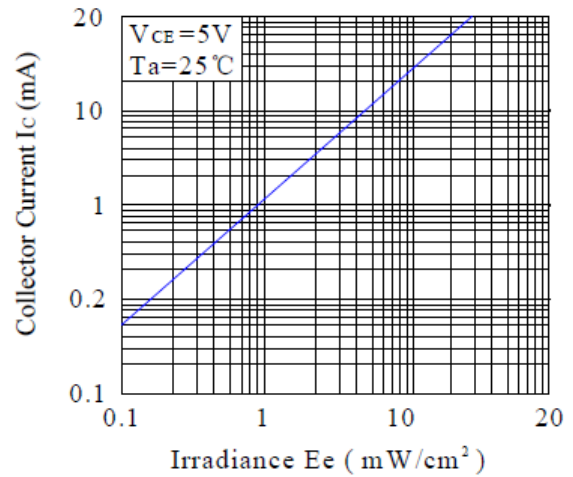

Relative Collector Current & Ambient Temperature

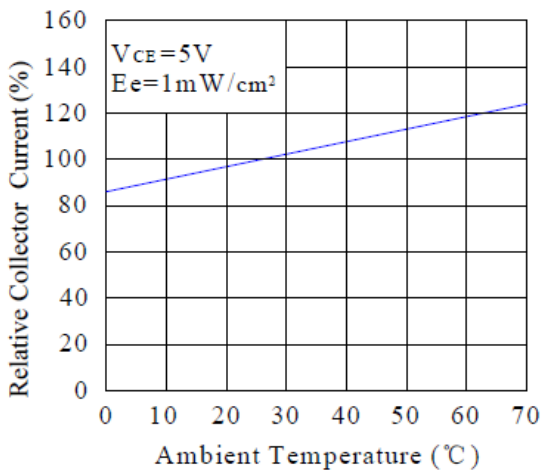

Collector Power Dissipation & Ambient Temperature

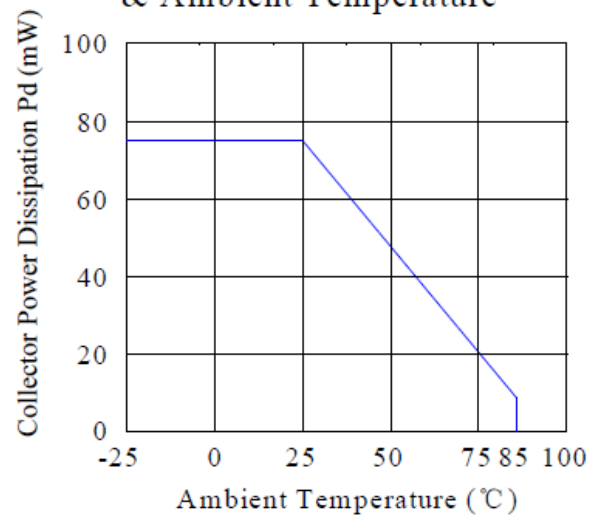

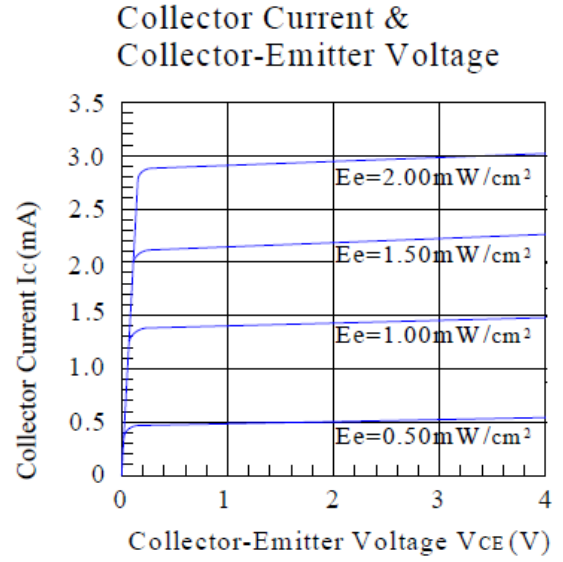
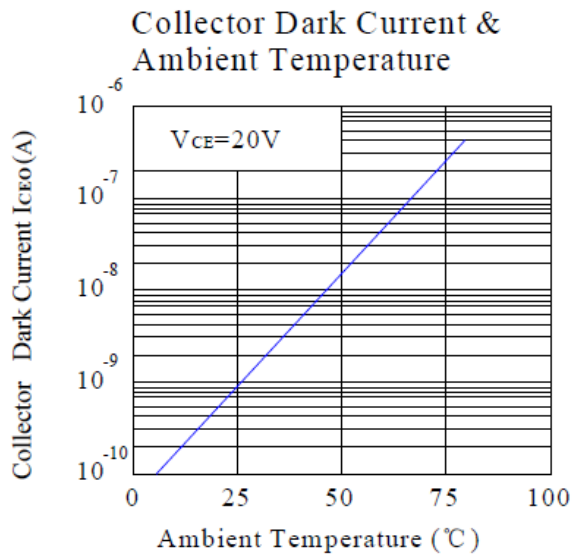

### Ordering Information

Product	Symbol	Parameters	Test conditions	Min	Typ	Max	Units	Orderable Part Number
INL-3ANPT30	I <sub>C(ON)</sub>	On State Collector Current	E <sub>e</sub> =1mW/cm <sup>2</sup> λ <sub>p</sub> =940nm, V <sub>CE</sub> =5V	0.7	2.5	-	mA	INL-3ANPT30

### Label Specifications

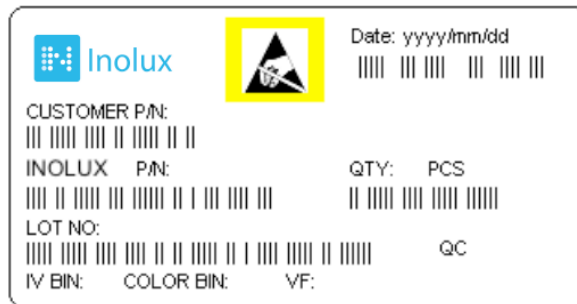

### Inolux P/N:

I	N	L	-	3	A	N	PT	3	0	.	X	X	X	X
Inolux Lamp Type				Package	Lens	Color	View Angle	Customized Stamp-off						
				3A = standard 3mm	N = Black Epoxy	PT = Photo Transistor	30 = 30 deg.							

### Lot No.:

Z	2	0	1	7	01	24	001
Internal Tracker	Year (2017, 2018, .....)				Month	Date	Serial

**Reliability**

Item	Frequency/ lots/ samples/ failures	Standards Reference	Conditions
Precondition	For all reliability monitoring tests according to JEDEC Level 2	J-STD-020	1.) Baking at 85°C for 24hrs 2.) Moisture storage at 85°C/ 60% R.H. for 168hrs
Solderability	1Q/ 1/ 22/ 0	JESD22-B102-B And CNS-5068	Accelerated aging 155°C/ 24hrs Tinning speed: 2.5+0.5cm/s Tinning: A: 215°C/ 3+1s or B: 260°C/ 10+1s
Resistance to soldering heat		CNS-5067	Dipping soldering terminal only Soldering bath temperature A: 260+/-5°C; 10+/-1s B: 350+/-10°C; 3+/-0.5s
Operating life test	1Q/ 1/ 40/ 0	CNS-11829	1.) Precondition: 85°C baking for 24hrs 85°C/ 60%R.H. for 168hrs 2.) Tamb25°C; IF=20mA; duration 1000hrs
High humidity, high temperature bias	1Q/ 1/ 45/ 0	JESD-A101-B	Tamb: 85°C Humidity: 85% R.H., IF=5mA Duration: 1000hrs
High temperature bias	1Q/ 1/ 20	IN specs.	Tamb: 55°C IF=20mA Duration: 1000hrs
Pulse life test	1Q/ 1/ 40/ 0		Tamb25°C, If=20mA,, Ip=100mA, Duty cycle=0.125 (tp=125 μs, T=1sec) Duration 500hrs)
Temperature cycle	1Q/ 1/ 76/ 0	JESD-A104-A IEC 68-2-14, Nb	A cycle: -40 degree C 15min; +85 degree C 15min Thermal steady within 5 min.. 300 cycles 2 chamber/ Air-to-air type
High humidity storage test	1Q/ 1/ 40/ 0	CNS-6117	60+3°C 90+5/-10% R.H. for 500hrs
High temperature storage test	1Q/ 1/ 40/ 0	CNS-554	100+10°C for 500hrs
Low temperature storage test	1Q/ 1/ 40/ 0	CNS-6118	-40+5°C for 500hrs

## Revision History

Changes since last revision	Page	Version No.	Revision Date
Initial Release		1.0	01-24-2019

## DISCLAIMER

INOLUX reserves the right to make changes without further notice to any products herein to improve reliability, function or design. INOLUX does not assume any liability arising out of the application or use of any product or circuit described herein; neither does it convey any license under its patent rights, nor the rights of others.

## LIFE SUPPORT POLICY

INOLUX's products are not authorized for use as critical components in life support devices or systems without the express written approval of the President of INOLUX or INOLUX CORPORATION. As used herein:

1. Life support devices or systems are devices or systems which, (a) are intended for surgical implant into the body, or (b) support or sustain life, and (c) whose failure to perform when properly used in accordance with instructions for use provided in the labeling, can be reasonably expected to result in a significant injury of the user.
2. A critical component in any component of a life support device or system whose failure to perform can be reasonably expected to cause the failure of the life support device or system, or to affect its safety or effectiveness.