



DC COMPONENTS CO., LTD.

RECTIFIER SPECIALISTS

**SS12
THRU
SS18**

TECHNICAL SPECIFICATIONS OF SURFACE MOUNT SCHOTTKY BARRIER RECTIFIER
VOLTAGE RANGE - 20 to 80 Volts **CURRENT - 1.0 Ampere**

FEATURES

- * Ideal for surface mounted applications
- * Low leakage current
- * Glass passivated junction

MECHANICAL DATA

- * Case: Molded plastic
- * Epoxy: UL 94V-0 rate flame retardant
- * Terminals: Solder plated solderable per MIL-STD-750, Method 2026
- * Polarity: As marked
- * Mounting position: Any
- * Weight: 0.064 gram

MAXIMUM RATINGS AND ELECTRICAL CHARACTERISTICS

Ratings at 25 °C ambient temperature unless otherwise specified.
 Single phase, half wave, 60 Hz, resistive or inductive load.
 For capacitive load, derate current by 20%.



SMA (DO-214AC)

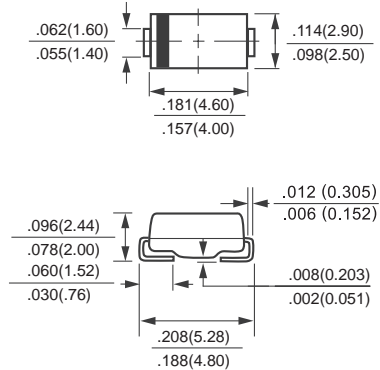

Dimensions in inches and (millimeters)

	SYMBOL	SS12	SS13	SS14	SS15	SS16	SS18	UNITS
Maximum Recurrent Peak Reverse Voltage	V _{RRM}	20	30	40	50	60	80	Volts
Maximum RMS Voltage	V _{RMS}	14	21	28	35	42	56	Volts
Maximum DC Blocking Voltage	V _{DC}	20	30	40	50	60	80	Volts
Maximum Average Forward Rectified Current at Derating Lead Temperature	I _O	1.0						Amps
Peak Forward Surge Current 8.3 ms single half sine-wave superimposed on rated load (JEDEC Method)	I _{FSM}	30						Amps
Maximum Instantaneous Forward Voltage at 1.0A DC	V _F	0.55		0.70		0.85		Volts
Maximum DC Reverse Current at Rated DC Blocking Voltage	I _R	@T _A = 25°C						mAmps
		@T _A = 100°C						
Typical Thermal Resistance (Note 1)	R _{θJA}	88						°C/W
Typical Junction Capacitance (Note 2)	C _J	110						pF
Operating Temperature Range	T _J	-65 to + 125						°C
Storage Temperature Range	T _{STG}	-65 to + 150						°C

- NOTES : 1. Thermal Resistance (Junction to Ambient).
 2. Measured at 1 MHz and applied reverse voltage of 4.0 volts.
 3. P.C.B Mounted with 0.2X0.2*(5.0X5.0mm²) copper pad area.

RATING AND CHARACTERISTIC CURVES (SS12 THRU SS18)

FIG. 1 - TYPICAL FORWARD CURRENT DERATING CURVE

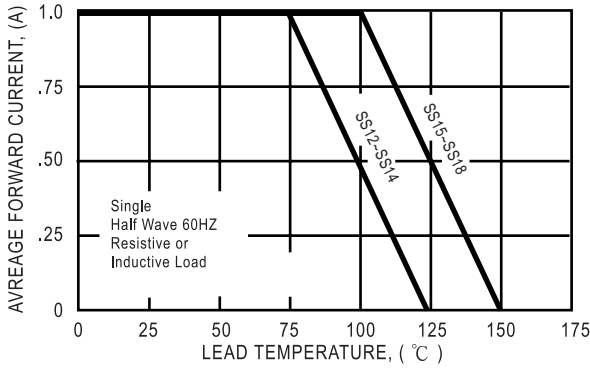

FIG. 2 - TYPICAL INSTANTANEOUS FORWARD CHARACTERISTICS

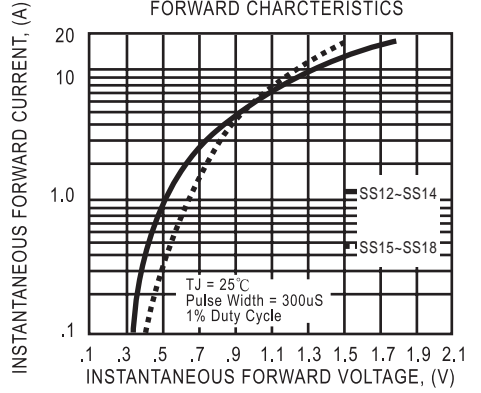

FIG. 3A - TYPICAL REVERSE CHARACTERISTICS

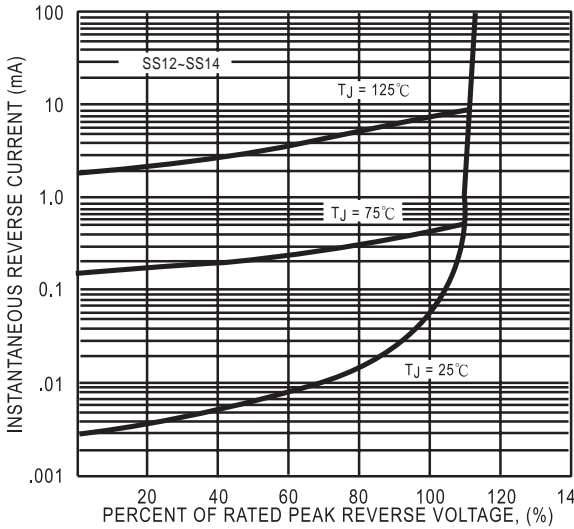

FIG. 3 - TYPICAL REVERSE CHARACTERISTICS

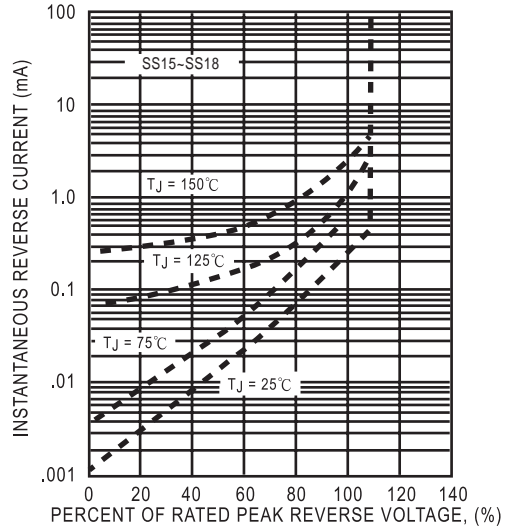

FIG. 4 - TYPICAL JUNCTION CAPACITANCE

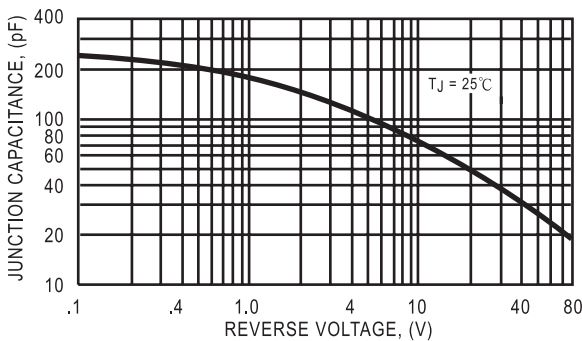
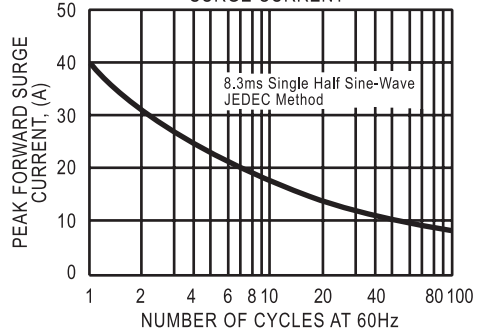

FIG. 5 - MAXIMUM NON-REPETITIVE FORWARD SURGE CURRENT



DC COMPONENTS CO., LTD.