

KEMET Part Number: SC-05-500
(UALSC055000000)

KEMET, SC, AC Line Filters, Common Mode, 5000 uH

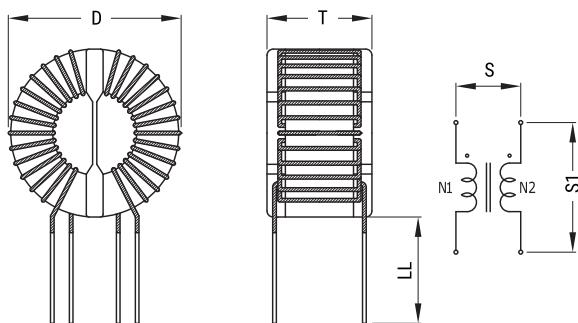

Dimensions

D	34mm MAX
T	23mm MAX
LL	15mm +/-2mm
S	7mm NOM

Packaging Specifications

Packaging:	Tray
Packaging Quantity:	200
Weight:	30 g

General Information

Series:	SC
Style:	Through-Hole
RoHS:	Yes
Notes:	Lead Spacing (S/S1) Are For Reference Only.
Miscellaneous:	Temperature Rise Maximum: 50 K

Specifications

Voltage AC:	250 VAC
Inductance:	5 mH (100 kHz)
Current:	4 A
Temperature Range:	-25/+105°C
DC Resistance:	80 mOhms