

## Line Follower click

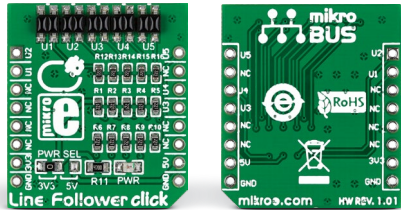

### 1. Introduction

Line Follower click carries an array of five **QRE1113** miniature reflective object sensors. For communicating with the target MCU, the individual sensors have their own separate digital outputs, each one routed through a single mikroBUS™ pin: OUT1, OUT2, OUT3, OUT4 and OUT5 (in place of default mikroBUS™ pins RST, AN, PWM, TX and RX, respectively). Line Follower click is designed to use either a 3.3V or a 5V power supply.

### 2. Soldering the headers

Before using your click board™, make sure to solder 1x8 male headers to both left and right side of the board. Two 1x8 male headers are included with the board in the package.

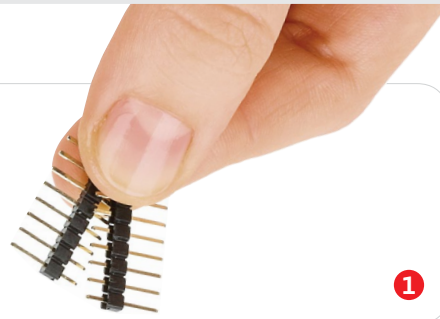

1

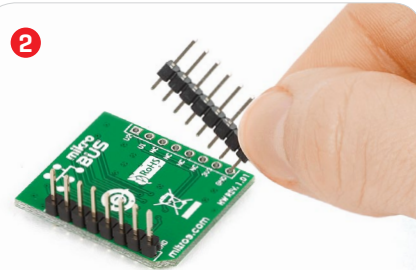

Turn the board upside down so that the bottom side is facing you upwards. Place shorter pins of the header into the appropriate soldering pads.

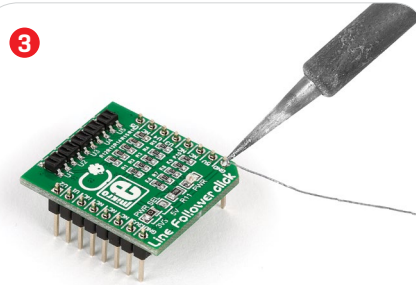
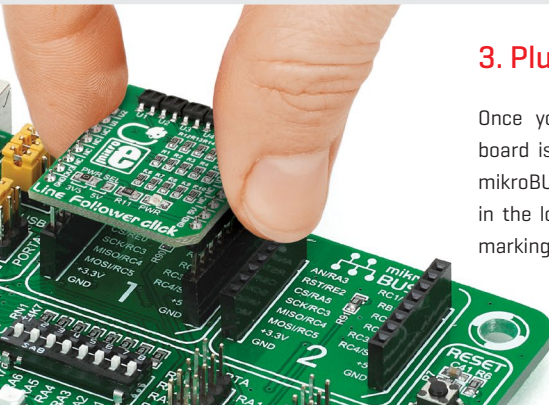

Turn the board upward again. Make sure to align the headers so that they are perpendicular to the board, then solder the pins carefully.

### 3. Plugging the board in

Once you have soldered the headers your board is ready to be placed into the desired mikroBUS™ socket. Make sure to align the cut in the lower-right part of the board with the markings on the silkscreen at the mikroBUS™ socket. If all the pins are aligned correctly, push the board all the way into the socket.

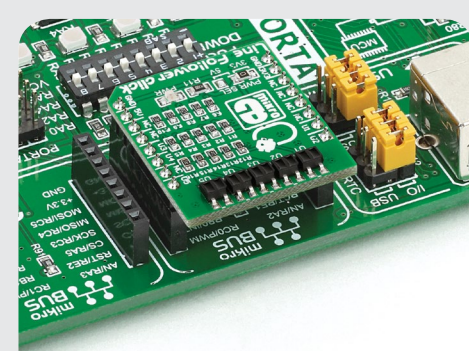

### 4. Essential features

As the name implies, *Line Follower click* is best used for line following robots and cars. Each one of the QRE1113 sensors consist of an infrared transmitter and infrared receiver. By default the sensor output a Logic Level 1, until they encounter a white surface which changes the output signal to 0. This is because white surfaces are more reflective. Since there's 5 adjacent sensors, you can deduce the position or thickness of the white line from the combination of their outputs.



Line Follower click Manual v101



0100000090459

## 5. Schematic

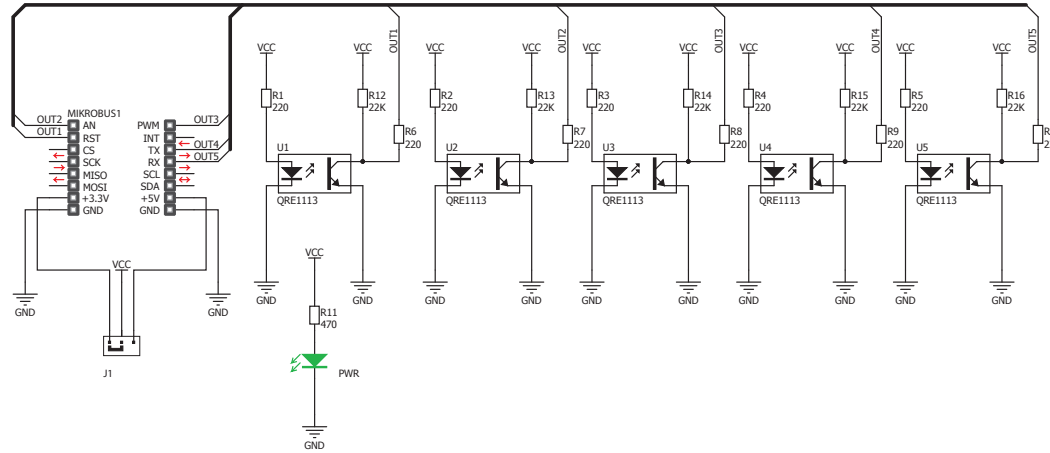

## 6. Dimensions

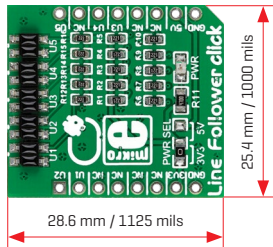

	mm	mils
LENGTH	28.6	1125
WIDTH	25.4	1000
HEIGHT*	3.3	130

\* without headers

## 7. SMD jumper

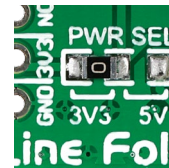

Line Follower click features an SMD jumper [zero ohm resistor] that let's you switch between a 3.3V or a 5V power supply.

## 8. Code examples

Once you have done all the necessary preparations, it's time to get your click board™ up and running. We have provided examples for mikroC™, mikroBasic™ and mikroPascal™ compilers on our **Libstock** website. Just download them and you are ready to start.



## 9. Support

MikroElektronika offers **free tech support** [[www.mikroe.com/support](http://www.mikroe.com/support)] until the end of the product's lifetime, so if something goes wrong, we're ready and willing to help!



## 10. Disclaimer

MikroElektronika assumes no responsibility or liability for any errors or inaccuracies that may appear in the present document. Specification and information contained in the present schematic are subject to change at any time without notice.

Copyright © 2015 MikroElektronika.  
All rights reserved.

# Mouser Electronics

Authorized Distributor

Click to View Pricing, Inventory, Delivery & Lifecycle Information:

[Mikroe:](#)

[MIKROE-1999](#)