

MODEL: CN8038-40HB P8



ELECTRICAL SPECIFICATION:

Item	Unit	Standard
Resonant Frequency	KHz	80 ± 2
Resonant Impedance	Ω	25 ↓
Capacitance	PF	3800 ± 10%
Diameter	MM	40
Total height	MM	59
Insulation Impedance	MΩ	10000 ↑
Rated Power	W	60

Backnail: welded to substrate by Argon Arc Welding Technology.

Sticker: welded to substrate by Energy Storage Type Studs Gun Welding Technology.

Backnail or Sticker is just for transducers which with threaded hole in radiating surface.

Please tell us what kind of screw you need.

The correct method of installation as follows.

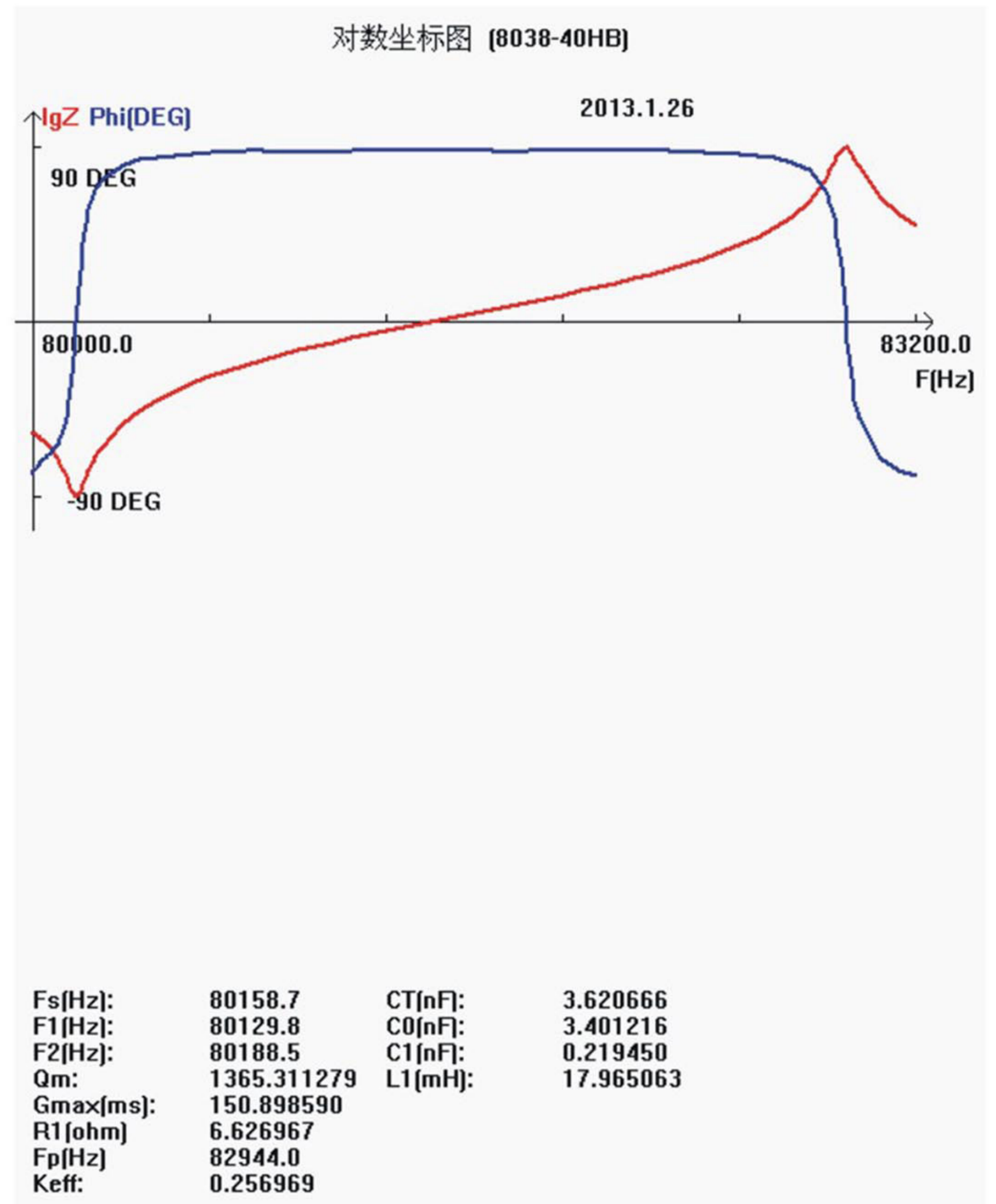
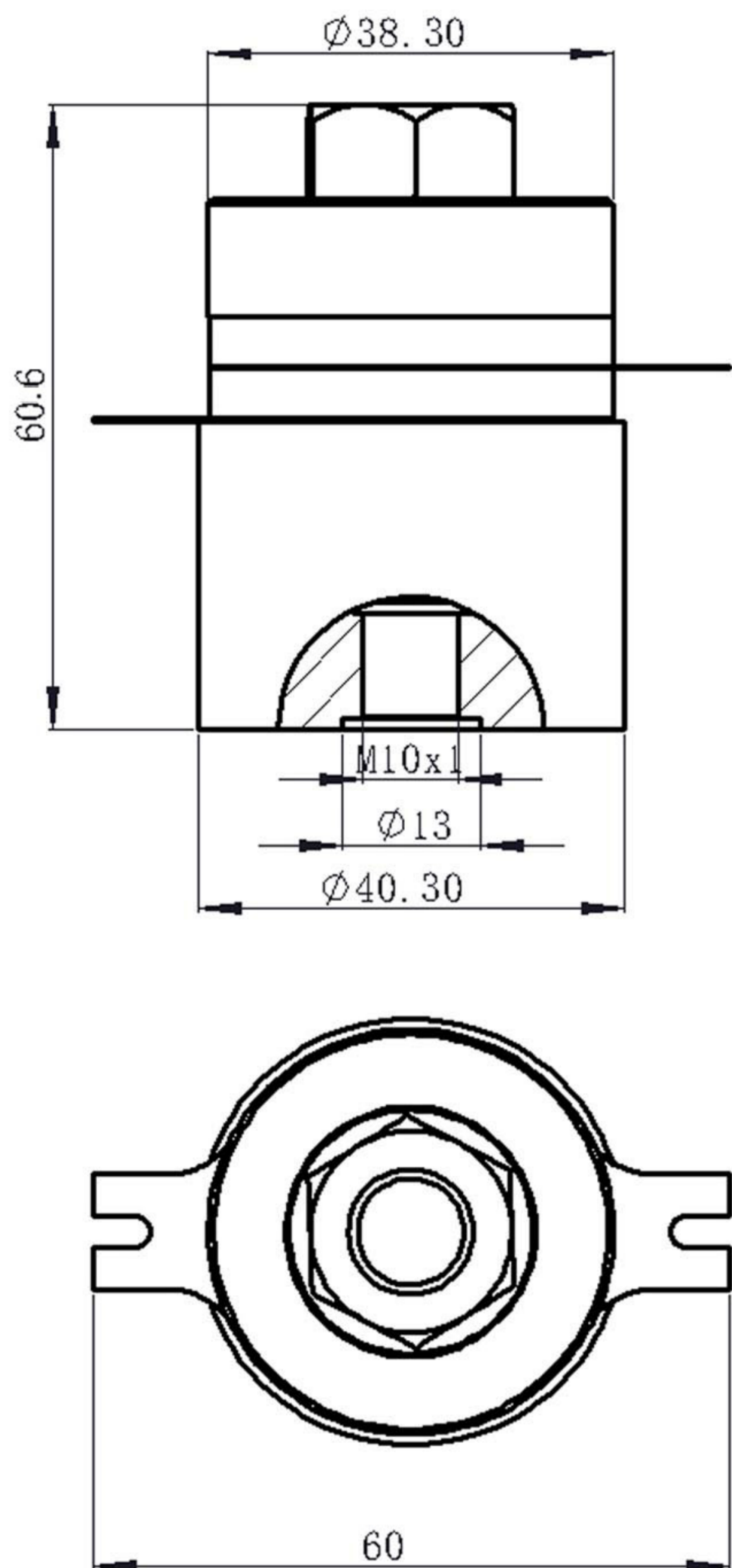
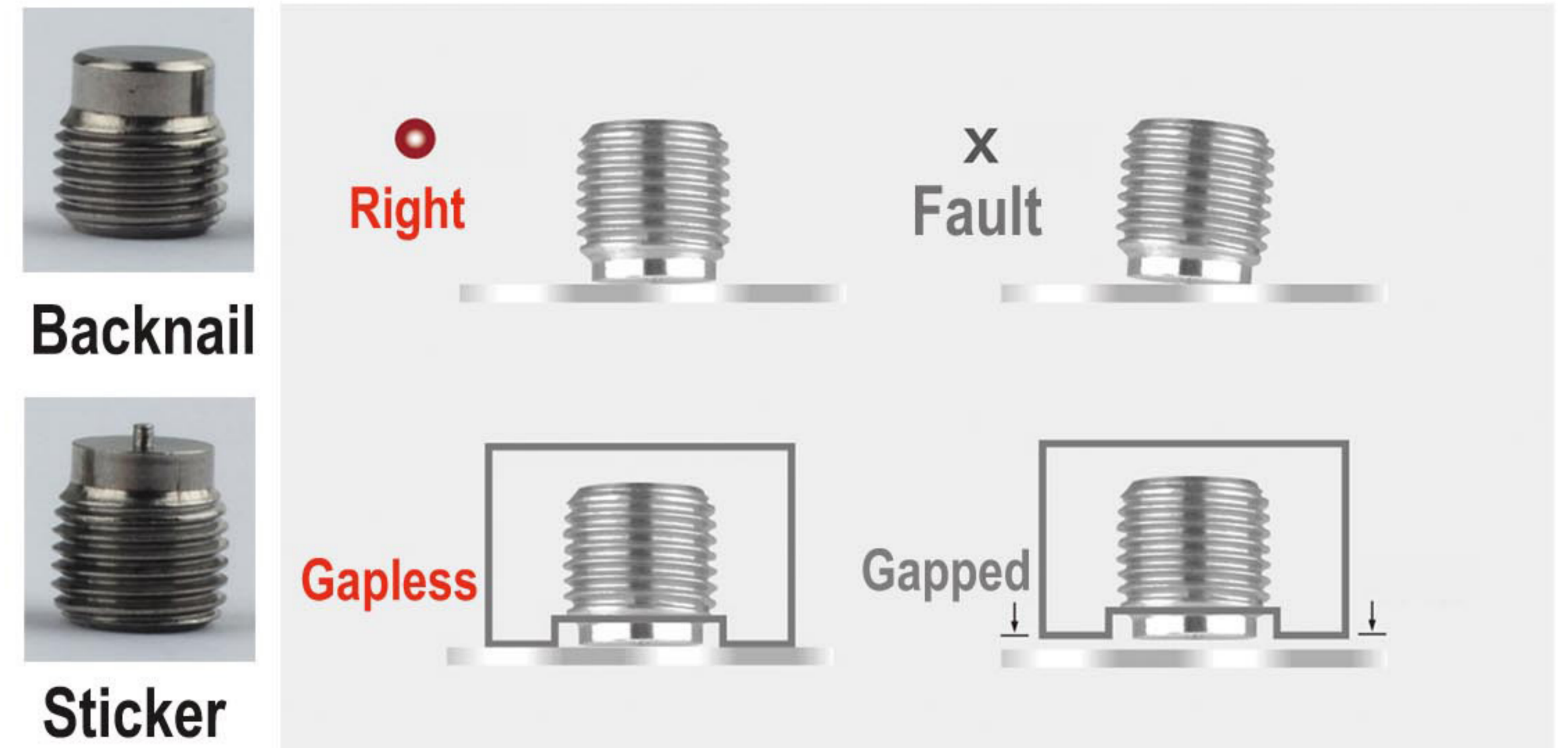

Tel:086-576-87276622 Email:info@clangsonic.com

Website:www.clangsonic.com

