

# LM49151 Boomer™ Audio Power Amplifier Series Mono Class D Audio Subsystem with Earpiece Driver, Ground Referenced Headphone Amplifiers, Speaker Protection and No Clip with Clip Control

Check for Samples: [LM49151](#)

## FEATURES

- E<sup>2</sup>S Class D Amplifier
- Ground Referenced Outputs — Eliminates Output Coupling Capacitors
- I<sup>2</sup>C Programmable No Clip Function with Clip Control
- Voltage Limiter Speaker Protection
- I<sup>2</sup>C Volume and Mode Control
- Ear Piece Amplifier
- Advanced Click-and-Pop Suppression
- Low Supply Current
- Micro-Power Shutdown
- 20-bump DSBGA Package

## APPLICATIONS

- Mobile Phones
- PDAs
- Notebook PCs
- Portable Electronics Devices
- MP3 Players

## KEY SPECIFICATIONS

- Output Power at  $V_{DD} = 3.3V$  THD+N  $\leq 1\%$ 
  - LS Mode,  $R_L = 8\Omega$  520mW (Typ)
  - HP Mode,  $R_L = 32\Omega$  40mW (Typ)
- Output Power at  $V_{DD} = 5V$  THD+N  $\leq 1\%$ 
  - LS Mode,  $R_L = 8\Omega$  1.25W (Typ)
  - HP Mode,  $R_L = 32\Omega$  42mW (Typ)
- Output Offset
  - LS Mode 15 6mV (Typ)
  - HP Mode 15 2mV (Typ)

## DESCRIPTION

The LM49151 is a fully integrated audio subsystem designed for portable handheld applications such as cellular phones. The LM49151 combines a 1.25W mono E<sup>2</sup>S class D amplifier, 125mW Class AB earpiece driver, 42mW/channel stereo ground referenced headphone drivers, volume control, input mixer/multiplexer, and speaker protection into a single device.

The LM49151 class D speaker amplifier features Texas Instruments' unique Automatic Level Control (ALC) that provides both a I<sup>2</sup>C programmable no-clip feature with Clip Controls and speaker protection. The E<sup>2</sup>S (Enhanced Emission Suppression) class D amplifier features a patented, ultra low EMI PWM architecture that significantly reduces RF emissions while preserving audio quality and efficiency while delivering 1.25W into an 8 $\Omega$  load with <1% THD+N with a 5V supply. The 42mW/channel headphone drivers feature Texas Instruments' ground referenced architecture that creates a ground-referenced output from a single supply, eliminating the need for bulky and expensive DC-blocking capacitors, saving space and minimizing system cost.

The LM49151 features separate volume controls for the loudspeaker and headphone inputs. Mode selection, shutdown control, and volume are controlled through an I<sup>2</sup>C compatible interface. The LM49151's superior click and pop suppression eliminates audible transients on power-up/down and during shutdown.



Please be aware that an important notice concerning availability, standard warranty, and use in critical applications of Texas Instruments semiconductor products and disclaimers thereto appears at the end of this data sheet.

Boomer is a trademark of Texas Instruments.

All other trademarks are the property of their respective owners.

Typical Application

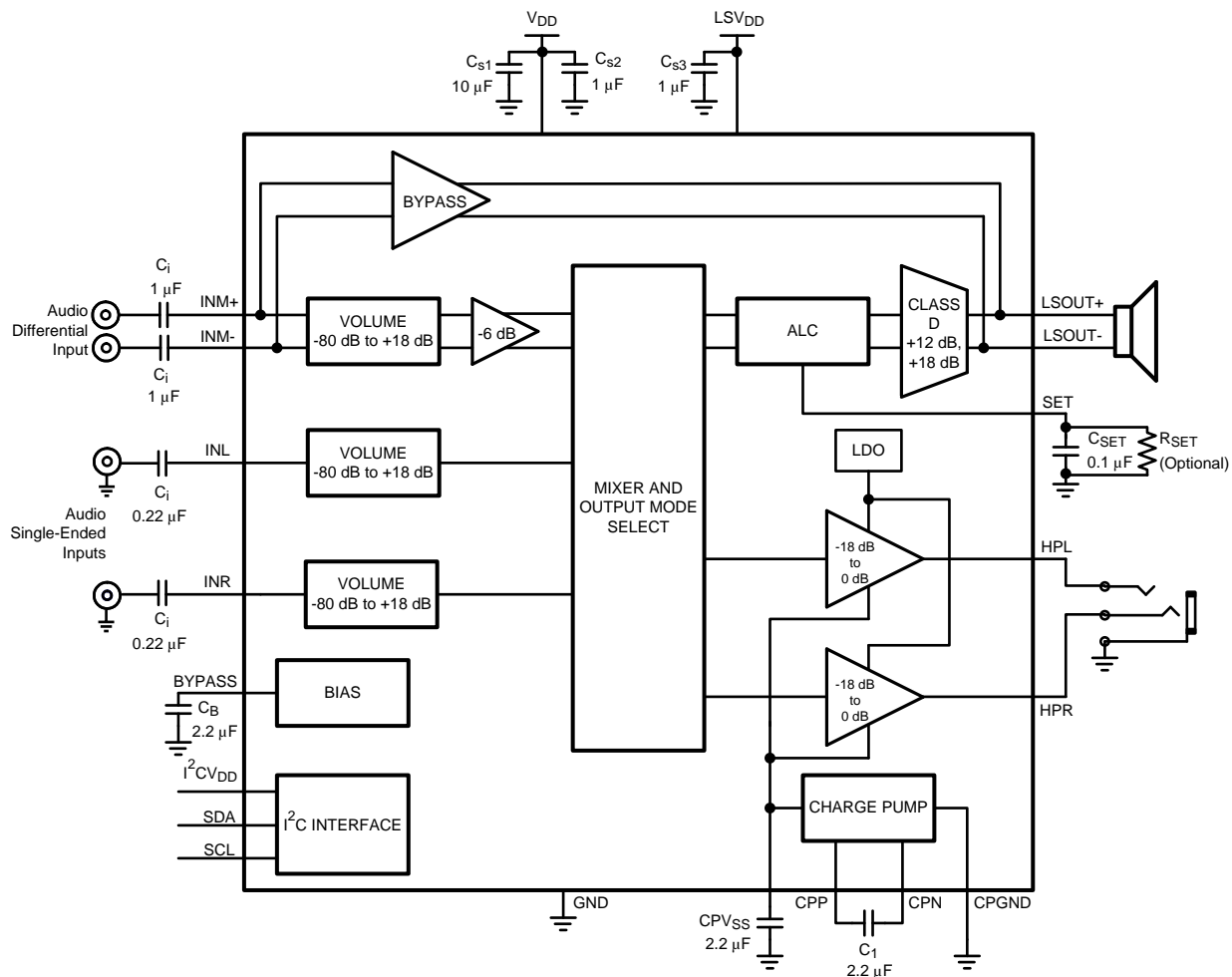
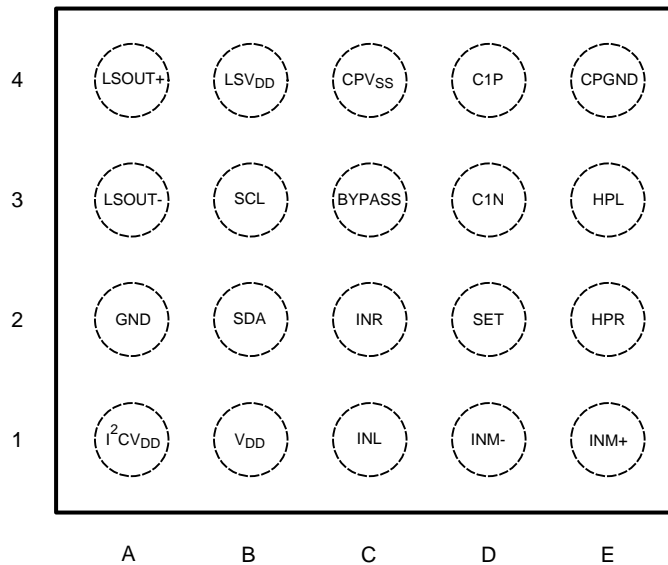

Figure 1. Typical Audio Amplifier Application Circuit

**Connection Diagram**

**Figure 2. 20 Bump DSBGA Package  
Top View  
(See Package Number YZR0020)**

**BUMP DESCRIPTIONS**

Bump	Name	Description
A1	I <sup>2</sup> CV <sub>DD</sub>	I <sup>2</sup> C Power Supply
A2	GND	Ground
A3	LSOUT-	Inverting Loudspeaker Output
A4	LSOUT+	Non-Inverting Loudspeaker Output
B1	V <sub>DD</sub>	Analog Power Supply
B2	SDA	I <sup>2</sup> C Data Input
B3	SCL	I <sup>2</sup> C Clock Input
B4	LSV <sub>DD</sub>	Loudspeaker Power Supply
C1	INL	Left Channel Input
C2	INR	Right Channel Input
C3	BYPASS	Mid-Rail Supply Bypass
C4	CPV <sub>SS</sub>	Charge Pump Output
D1	INM-	Mono Channel Inverting Input
D2	SET	ALC Timing Control
D3	CPN	Charge Pump Flying Capacitor - Negative Terminal
D4	CPP	Charge Pump Flying Capacitor - Positive Terminal
E1	INM+	Mono Channel Non-Inverting Input
E2	HPR	Right Channel Headphone Amplifier Output
E3	HPL	Left Channel Headphone Amplifier Output
E4	CPGND	Charge Pump Ground



These devices have limited built-in ESD protection. The leads should be shorted together or the device placed in conductive foam during storage or handling to prevent electrostatic damage to the MOS gates.

### Absolute Maximum Ratings<sup>(1)(2)(3)</sup>

Supply Voltage <sup>(1)</sup>	6.0V	
Storage Temperature	-65°C to +150°C	
Input Voltage	-0.3 to V <sub>DD</sub> +0.3	
Power Dissipation <sup>(4)</sup>	Internally Limited	
ESD Rating <sup>(5)</sup>	2.0kV	
ESD Rating <sup>(6)</sup>	200V	
Junction Temperature	150°C	
Soldering Information	See AN-1112 (SNVA009) "DSBGA Wafer Level Chip Scale Package"	
Thermal Resistance	$\theta_{JA}$ (typ) - YZR0020	46.1°C/W

- (1) "Absolute Maximum Ratings" indicate limits beyond which damage to the device may occur, including inoperability and degradation of device reliability and/or performance. Functional operation of the device and/or non-degradation at the *Absolute Maximum Ratings* or other conditions beyond those indicated in the *Recommended Operating Conditions* is not implied. The *Recommended Operating Conditions* indicate conditions at which the device is functional and the device should not be operated beyond such conditions. All voltages are measured with respect to the ground pin, unless otherwise specified.
- (2) The *Electrical Characteristics* tables list ensured specifications under the listed *Recommended Operating Conditions* except as otherwise modified or specified by the *Electrical Characteristics Conditions* and/or Notes. Typical specifications are estimations only and are not ensured.
- (3) If Military/Aerospace specified devices are required, please contact the Texas Instruments Sales Office/Distributors for availability and specifications.
- (4) The maximum power dissipation must be derated at elevated temperatures and is dictated by T<sub>JMAX</sub>,  $\theta_{JA}$ , and the ambient temperature, T<sub>A</sub>. The maximum allowable power dissipation is P<sub>DMAX</sub> = (T<sub>JMAX</sub> - T<sub>A</sub>) /  $\theta_{JA}$  or the number given in *Absolute Maximum Ratings*, whichever is lower.
- (5) Human body model, applicable std. JESD22-A114C.
- (6) Machine model, applicable std. JESD22-A115-A.

### Operating Ratings

Temperature Range	-40°C ≤ T <sub>A</sub> ≤ +85°C
Supply Voltage (V <sub>DD</sub> , LSV <sub>DD</sub> )	2.7V ≤ V <sub>DD</sub> ≤ 5.5V
Supply Voltage (I <sup>2</sup> CV <sub>DD</sub> )	1.7V ≤ I <sup>2</sup> CV <sub>DD</sub> ≤ 5.5V
	I <sup>2</sup> CV <sub>DD</sub> ≤ V <sub>DD</sub>

### Electrical Characteristics 3.3V<sup>(1)(2)</sup>

The following specifications apply for LS and HP VOLUME<sub>GAIN</sub> = 0dB, LSG<sub>GAIN</sub> = 12dB, HPG<sub>GAIN</sub> = 0dB R<sub>L</sub> = 8Ω+30μH (Loudspeaker), R<sub>L</sub> = 32Ω (Headphone), R<sub>L</sub> = 8Ω (Earpiece), C<sub>SET</sub> = 0.1μF, ALC disabled, f = 1kHz, unless otherwise specified. Limits apply for T<sub>A</sub> = 25°C. (Note 7).

Symbol	Parameter	Conditions	LM49151		Units (Limits)
			Typical <sup>(3)</sup>	Limits <sup>(4)</sup>	
I <sub>DD</sub>	Supply Current	V <sub>IN</sub> = 0, No Load			
		LS mode 1	3.7	5.5	mA (max)
		LS Mode 1, ALC enabled	4	6	mA (max)
		HP Mode 8	4.9	7	mA (max)
		EP Bypass Mode	0.8	1.3	mA (max)
		LS+HP Mode 5 and 10	7	10.5	mA (max)
		LS Mode 1, GAMP_SD = 1	3		mA
		HP Mode 8, GAMP_SD = 1	4.3		mA

- (1) "Absolute Maximum Ratings" indicate limits beyond which damage to the device may occur, including inoperability and degradation of device reliability and/or performance. Functional operation of the device and/or non-degradation at the *Absolute Maximum Ratings* or other conditions beyond those indicated in the *Recommended Operating Conditions* is not implied. The *Recommended Operating Conditions* indicate conditions at which the device is functional and the device should not be operated beyond such conditions. All voltages are measured with respect to the ground pin, unless otherwise specified.
- (2) The *Electrical Characteristics* tables list ensured specifications under the listed *Recommended Operating Conditions* except as otherwise modified or specified by the *Electrical Characteristics Conditions* and/or Notes. Typical specifications are estimations only and are not ensured.
- (3) Typical values represent most likely parametric norms at T<sub>A</sub> = +25°C, and at the *Recommended Operation Conditions* at the time of product characterization and are not ensured.
- (4) Datasheet min/max specification limits are specified by test or statistical analysis.

**Electrical Characteristics 3.3V<sup>(1)(2)</sup> (continued)**

The following specifications apply for LS and HP VOLUME GAIN = 0dB, LSGAIN = 12dB, HPGAIN = 0dB  $R_L = 8\Omega + 30\mu\text{H}$  (Loudspeaker),  $R_L = 32\Omega$  (Headphone),  $R_L = 8\Omega$  (Earpiece),  $C_{SET} = 0.1\mu\text{F}$ , ALC disabled,  $f = 1\text{kHz}$ , unless otherwise specified. Limits apply for  $T_A = 25^\circ\text{C}$ . (Note 7).

Symbol	Parameter	Conditions	LM49151		Units (Limits)
			Typical <sup>(3)</sup>	Limits <sup>(4)</sup>	
$I_{SD}$	Shutdown Current		0.04	1	$\mu\text{A}$ (max)
$V_{OS}$	Output Offset Voltage	$V_{IN} = 0$			
		LS Mode 5, mono input	10		mV
		HP Mode 5, mono input	2	6	mV (max)
		EP Bypass Mode, 1mono input	0.8	5	mV (max)
		LS Mode 10, stereo input	10		mV
		HP Mode 10, stereo input	2	6	mV (max)
		LS Mode 15, stereo + mono input	10		mV
		HP Mode 15, stereo + mono input	2	6	mV (max)
$t_{WU}$	Wake Up Time	HP Mode, $C_{BYPASS} = 2.2\mu\text{F}$ Normal, $TURN\_ON\_TIME = 0$ Fast, $TURN\_ON\_TIME = 1$	27 15		ms ms
		Minimum Gain Setting	-80		dB (min) dB (max)
$A_{VOL}$	Volume Control	Maximum Gain Setting	18		dB
		Volume Control Step Error	$\pm 0.2$		dB
$A_V$	Gain	LS Mode			
		Gain 0	12		dB
		Gain 1	18		dB
		HP Mode			
		Gain 0	0		dB
		Gain 1	-1.5		dB
		Gain 2	-3		dB
		Gain 3	-6		dB
		Gain 4	-9		dB
		Gain 5	-12		dB
Gain 6	-15		dB		
Gain 7	-18		dB		
$A_{VMUTE}$	Mute Attention	LS Output, HP Mode $P_{OUT} = 20\text{mW}$	-96		dB
		HP Output, LS Mode $P_{OUT} = 250\text{mW}$	-96		dB
$R_{IN}$	Input Resistance	MONO, RIN, LIN, Inputs			
		Maximum Gain Setting	13	11 15.5	k $\Omega$ (min) k $\Omega$ (max)
		Minimum Gain Setting	110	90 130	k $\Omega$ (min) k $\Omega$ (max)
		EP Bypass Mode	62	50 80	k $\Omega$ (min) k $\Omega$ (max)
$P_O$	Output Power	$f = 1\text{kHz}$ , THD+N = 1% Two channels in phase			
		LS Mode 1	520	450	mW (min)
		HP Mode 8, $R_L = 16\Omega$	40		mW
		HP Mode 8, $R_L = 32\Omega$	40	30	mW (min)
		EP Bypass Mode, $R_L = 8\Omega$	35	26	mW (min)

### Electrical Characteristics 3.3V<sup>(1)(2)</sup> (continued)

The following specifications apply for LS and HP VOLUME GAIN = 0dB, LSGAIN = 12dB, HPGAIN = 0dB  $R_L = 8\Omega + 30\mu\text{H}$  (Loudspeaker),  $R_L = 32\Omega$  (Headphone),  $R_L = 8\Omega$  (Earpiece),  $C_{SET} = 0.1\mu\text{F}$ , ALC disabled,  $f = 1\text{kHz}$ , unless otherwise specified. Limits apply for  $T_A = 25^\circ\text{C}$ . (Note 7).

Symbol	Parameter	Conditions	LM49151		Units (Limits)
			Typical (3)	Limits (4)	
THD+N	Total Harmonic Distortion + Noise	$f = 1\text{kHz}$			
		LS Mode 1, $P_O = 250\text{mW}$	0.02		%
		HP Mode 8, $P_O = 20\text{mW}$	0.015		%
		EP Bypass Mode, $R_L = 8\Omega$	0.15		%
PSRR	Power Supply Rejection Ratio	$f = 217\text{Hz}$ , $V_{RIPPLE} = 200\text{mV}_{PP}$ ; $C_B = 2.2\mu\text{F}$ All audio inputs terminated to AC GND, output referred			
		LS Mode 1, mono input	72		dB
		LS Mode 2, stereo input	67		dB
		LS mode 3, mono + stereo input	71		dB
		HP Mode 4, mono input	91		dB
		HP Mode 8, stereo input	83		dB
		HP Mode 12, mono + stereo input	81		dB
		EP Bypass Mode, mono input	95		dB
CMRR	Common Mode Rejection Ratio	$V_{RIPPLE} = 200\text{mV}_{P-P}$ , $f_{RIPPLE} = 217\text{Hz}$ , mono input			
		LS Mode 1	55		dB
		HP Mode 4	61		dB
		EP Bypass Mode	55		dB
$\eta$	Efficiency	LS Mode, $P_O = 500\text{mW}$	88		%
$X_{TALK}$	Crosstalk	HP Mode 8, $P_O = 12\text{mW}$ , $R_L = 32\Omega$ , $f = 1\text{kHz}$	78		dB
$\epsilon_{OS}$	Output Noise	A-weighted, Inputs AC GND			
		LS Mode 1, mono input	40		$\mu\text{V}$
		LS Mode 2, stereo input	47		$\mu\text{V}$
		LS Mode 3, mono + stereo input	48		$\mu\text{V}$
		HP Mode 4, mono input	9		$\mu\text{V}$
		HP Mode 8, stereo input	10		$\mu\text{V}$
		HP Mode 12, mono + stereo input	11		$\mu\text{V}$
		EP Bypass Mode, mono input	10		$\mu\text{V}$
SNR	Signal to Noise Ratio	LS Mode 1, $P_O = 500\text{mW}$	90		dB
		HP Mode 4, $P_O = 40\text{mW}$	102		dB
$T_A$	Attack Time	ATTACK_TIME = 00	0.75		ms
$T_R$	Release Time	RELEASE_TIME = 00	1		s
$V_{LIMIT}$	Output Voltage Limit	LS Mode 1, THD+N $\leq 1\%$ , VOLTAGE_LEVEL			
		001	4		$V_{P-P}$
		010	4.8		$V_{P-P}$
		011	5.6		$V_{P-P}$

**Electrical Characteristics 5.0V<sup>(1)(2)</sup>**

The following specifications apply for LS and HP VOLUME GAIN = 0dB, LSGAIN = 12dB, HPGAIN = 0dB  $R_L = 8\Omega + 30\mu\text{H}$  (Loudspeaker),  $R_L = 32\Omega$  (Headphone),  $R_L = 8\Omega$  (Earpiece),  $C_{SET} = 0.1\mu\text{F}$ , ALC disabled,  $f = 1\text{kHz}$ , unless otherwise specified. Limits apply for  $T_A = 25^\circ\text{C}$ . (Note 7).

Symbol	Parameter	Conditions	LM49151		Units (Limits)
			Typical <sup>(3)</sup>	Limits <sup>(4)</sup>	
$I_{DD}$	Supply Current	$V_{IN} = 0$ , No Load			
		LS mode 1, ALC disabled	4.6		mA
		LS Mode 1, ALC enabled	5.0		mA
		HP Mode 8	5.0		mA
		EP Bypass Mode	0.9		mA
		LS+HP Mode 5 and 10	7.7		mA
		LS Mode 1, GAMP_SD = 1	3.7		mA
		HP Mode 8, GAMP_SD = 1	4.4		mA
$I_{SD}$	Shutdown Current		0.04	1	$\mu\text{A}$ (max)
$V_{OS}$	Output Offset Voltage	$V_{IN} = 0$			
		LS Mode 5, mono input	10		mV
		HP Mode 5, mono input	2	6	mV (max)
		EP Bypass Mode, mono input	1.2	5	mV (max)
		LS Mode 10, stereo input	10		mV
		HP Mode 10, stereo input	2	6	mV (max)
		LS Mode 15, stereo + mono input	10		mV
		HP Mode 15, stereo + mono input	2	6	mV (max)
$t_{WU}$	Wake Up Time	HP Mode, $C_{BYPASS} = 2.2\mu\text{F}$ Normal, TURN_ON_TIME = 0 Fast, TURN_ON_TIME = 1	27 15		ms ms
		Minimum Gain Setting	-80		dB (min) dB (max)
$A_{VOL}$	Volume Control	Maximum Gain Setting	18		dB
		Volume Control Step Error	$\pm 0.2$		dB
$A_V$	Gain	LS Mode			
		Gain 0	12		dB
		Gain 1	18		dB
		HP Mode			
		Gain 0	0		dB
		Gain 1	-1.5		dB
		Gain 2	-3		dB
		Gain 3	-6		dB
		Gain 4	-9		dB
		Gain 5	-12		dB
		Gain 6	-15		dB
		Gain 7	-18		dB

- (1) "Absolute Maximum Ratings" indicate limits beyond which damage to the device may occur, including inoperability and degradation of device reliability and/or performance. Functional operation of the device and/or non-degradation at the Absolute Maximum Ratings or other conditions beyond those indicated in the Recommended Operating Conditions is not implied. The Recommended Operating Conditions indicate conditions at which the device is functional and the device should not be operated beyond such conditions. All voltages are measured with respect to the ground pin, unless otherwise specified.
- (2) The Electrical Characteristics tables list ensured specifications under the listed Recommended Operating Conditions except as otherwise modified or specified by the Electrical Characteristics Conditions and/or Notes. Typical specifications are estimations only and are not ensured.
- (3) Typical values represent most likely parametric norms at  $T_A = +25^\circ\text{C}$ , and at the Recommended Operation Conditions at the time of product characterization and are not ensured.
- (4) Datasheet min/max specification limits are specified by test or statistical analysis.

## Electrical Characteristics 5.0V<sup>(1)(2)</sup> (continued)

The following specifications apply for LS and HP VOLUME GAIN = 0dB, LSGAIN = 12dB, HPGAIN = 0dB  $R_L = 8\Omega + 30\mu\text{H}$  (Loudspeaker),  $R_L = 32\Omega$  (Headphone),  $R_L = 8\Omega$  (Earpiece),  $C_{SET} = 0.1\mu\text{F}$ , ALC disabled,  $f = 1\text{kHz}$ , unless otherwise specified. Limits apply for  $T_A = 25^\circ\text{C}$ . (Note 7).

Symbol	Parameter	Conditions	LM49151		Units (Limits)
			Typical <sup>(3)</sup>	Limits <sup>(4)</sup>	
A <sub>V</sub> MUTE	Mute Attention	LS Output, HP Mode P <sub>OUT</sub> = 20mW	-96		dB
		HP Output, LS Mode P <sub>OUT</sub> = 250mW	-96		dB
R <sub>IN</sub>	Input Resistance	MONO, RIN, LIN, Inputs			
		Maximum Gain Setting	13		kΩ
		Minimum Gain Setting	110		kΩ
		EP Bypass Mode	62		kΩ
P <sub>O</sub>	Output Power	f = 1kHz, THD+N = 1% Two channels in phase			
		LS Mode 1	1.25		W
		HP Mode 8, R <sub>L</sub> = 16Ω	42		mW
		HP Mode 8, R <sub>L</sub> = 32Ω	43		mW
		EP Bypass Mode, R <sub>L</sub> = 8Ω	137		mW
THD+N	Total Harmonic Distortion + Noise	f = 1kHz			
		LS Mode 1, P <sub>O</sub> = 600mW	0.015		%
		HP Mode 8, P <sub>O</sub> = 20mW	0.01		%
		EP Bypass Mode, P <sub>O</sub> = 60mW	0.09		%
PSRR	Power Supply Rejection Ratio	f = 217Hz, V <sub>RIPPLE</sub> = 200mV <sub>PP</sub> ; C <sub>B</sub> = 2.2μF All audio inputs terminated to AC GND, output referred			
		LS Mode 1, mono input, A <sub>V</sub> = 6dB	75		dB
		LS Mode 2, stereo input, A <sub>V</sub> = 6dB	71		dB
		LS mode 3, mono + stereo input, A <sub>V</sub> = 6dB	71		dB
		HP Mode 4, mono input	91		dB
		HP Mode 8, stereo input	80		dB
		HP Mode 12, mono + stereo input	79		dB
		EP Bypass Mode, mono input	97		dB
CMRR	Common Mode Rejection Ratio	V <sub>RIPPLE</sub> = 200mV <sub>P-P</sub> , f <sub>RIPPLE</sub> = 217Hz, mono input			
		LS Mode 1	55		dB
		HP Mode 4	61		dB
		EP Bypass Mode	55		dB
η	Efficiency	LS Mode, P <sub>O</sub> = 1W	88		%
X <sub>TALK</sub>	Crosstalk	HP Mode 8, P <sub>O</sub> = 12mW, R <sub>L</sub> = 32Ω, f = 1kHz	78		dB
ε <sub>OS</sub>	Output Noise	A-weighted, Inputs AC GND			
		LS Mode 1, mono input	41		μV
		LS Mode 2, stereo input	41		μV
		LS Mode 3, mono + stereo input	43		μV
		HP Mode 4, mono input	9		μV
		HP Mode 8, stereo input	10		μV
		HP Mode 12, mono + stereo input	12		μV
		EP Bypass Mode, mono input	11		μV
SNR	Signal to Noise Ratio	LS Mode 1, P <sub>O</sub> = 1.25W	96		dB
		HP Mode 4, P <sub>O</sub> = 40mW	102		dB



## Electrical Characteristics 5.0V<sup>(1)(2)</sup> (continued)

The following specifications apply for LS and HP VOLUME GAIN = 0dB, LSGAIN = 12dB, HPGAIN = 0dB  $R_L = 8\Omega + 30\mu\text{H}$  (Loudspeaker),  $R_L = 32\Omega$  (Headphone),  $R_L = 8\Omega$  (Earpiece),  $C_{SET} = 0.1\mu\text{F}$ , ALC disabled,  $f = 1\text{kHz}$ , unless otherwise specified. Limits apply for  $T_A = 25^\circ\text{C}$ . (Note 7).

Symbol	Parameter	Conditions	LM49151		Units (Limits)
			Typical <sup>(3)</sup>	Limits <sup>(4)</sup>	
$V_{LIMIT}$	Output Voltage Limit	LS Mode 1, THD+N $\leq$ 1%, VOLTAGE_LEVEL	4		$V_{P-P}$
		001	4.8		$V_{P-P}$
		010	5.6		$V_{P-P}$
		011	6.4		$V_{P-P}$
		101	7.2		$V_{P-P}$
		110	8		$V_{P-P}$

## I<sup>2</sup>C Interface Characteristics

$V_{DD} = 5\text{V}$ ,  $2.2\text{V} \leq I^2C V_{DD} \leq 5.5\text{V}$ <sup>(1)(2)</sup>

The following specifications apply for LS and HP VOLUME GAIN = 0dB, LSGAIN = 12dB, HPGAIN = 0dB  $R_L = 8\Omega + 30\mu\text{H}$  (Loudspeaker),  $R_L = 32\Omega$  (Headphone),  $R_L = 8\Omega$  (Earpiece),  $C_{SET} = 0.1\mu\text{F}$ , ALC disabled,  $f = 1\text{kHz}$ , unless otherwise specified. Limits apply for  $T_A = 25^\circ\text{C}$ . (Note 7).

Symbol	Parameter	Conditions	LM49151		Units (Limits)
			Typical	Limits <sup>(3)</sup>	
$t_1$	SCL Period			2.5	$\mu\text{s}$ (min)
$t_2$	SDA Setup Time			100	ns (min)
$t_3$	SDA Stable Time			0	ns (min)
$t_4$	Start Condition Time			100	ns (min)
$t_5$	Stop Condition Time			100	ns (min)
$t_6$	SDA Data Hold Time			100	ns (min)
$V_{IH}$	Input High Voltage			$0.7 \times I^2C V_{DD}$	V (min)
$V_{IL}$	Input Low Voltage			$0.3 \times I^2C V_{DD}$	V (max)

- (1) "Absolute Maximum Ratings" indicate limits beyond which damage to the device may occur, including inoperability and degradation of device reliability and/or performance. Functional operation of the device and/or non-degradation at the *Absolute Maximum Ratings* or other conditions beyond those indicated in the *Recommended Operating Conditions* is not implied. The *Recommended Operating Conditions* indicate conditions at which the device is functional and the device should not be operated beyond such conditions. All voltages are measured with respect to the ground pin, unless otherwise specified.
- (2) The *Electrical Characteristics* tables list ensured specifications under the listed *Recommended Operating Conditions* except as otherwise modified or specified by the *Electrical Characteristics Conditions* and/or Notes. Typical specifications are estimations only and are not ensured.
- (3) Datasheet min/max specification limits are specified by test or statistical analysis.

## I<sup>2</sup>C Interface Characteristics

$$V_{DD} = 3.3V, 1.7V \leq I^2CV_{DD} \leq 2.2V^{(1)(2)}$$

The following specifications apply for LS and HP VOLUME GAIN = 0dB, LSGAIN = 12dB, HPGAIN = 0dB  $R_L = 8\Omega$  (Loudspeaker),  $R_L = 32\Omega$  (Headphone),  $R_L = 8\Omega$  (Earpiece),  $C_{SET} = 0.1\mu F$ , ALC disabled,  $f = 1kHz$ , unless otherwise specified. Limits apply for  $T_A = 25^\circ C$ . (Note 7).

Symbol	Parameter	Conditions	LM49151		Units (Limits)
			Typical	Limits <sup>(3)</sup>	
$t_1$	SCL Period Time			2.5	$\mu s$ (min)
$t_2$	SCL Setup Time			250	ns (min)
$t_3$	SDA Stable Time			0	ns (min)
$t_4$	Start Condition Time			250	ns (min)
$t_5$	Stop Condition Time			250	ns (min)
$t_6$	I <sup>2</sup> C Data Hold Time			250	ns (min)
$V_{IH}$	Input Voltage High			$0.7 \times I^2CV_{DD}$	V (min)
$V_{IL}$	Input Voltage Low			$0.3 \times I^2CV_{DD}$	V (max)

- (1) "Absolute Maximum Ratings" indicate limits beyond which damage to the device may occur, including inoperability and degradation of device reliability and/or performance. Functional operation of the device and/or non-degradation at the *Absolute Maximum Ratings* or other conditions beyond those indicated in the *Recommended Operating Conditions* is not implied. The *Recommended Operating Conditions* indicate conditions at which the device is functional and the device should not be operated beyond such conditions. All voltages are measured with respect to the ground pin, unless otherwise specified.
- (2) The *Electrical Characteristics* tables list ensured specifications under the listed *Recommended Operating Conditions* except as otherwise modified or specified by the *Electrical Characteristics Conditions* and/or Notes. Typical specifications are estimations only and are not ensured.
- (3) Datasheet min/max specification limits are specified by test or statistical analysis.

**Typical Performance Characteristics<sup>(1)</sup>**

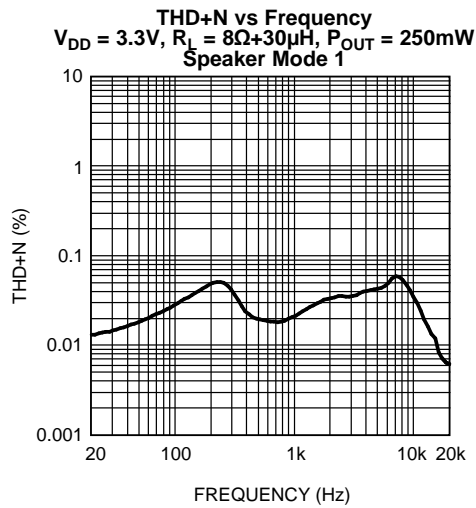

**Figure 3.**

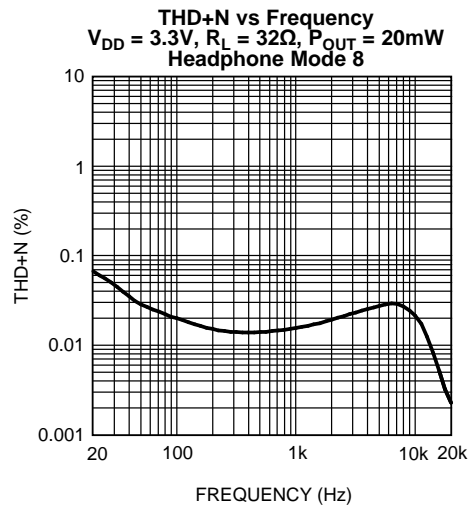

**Figure 4.**

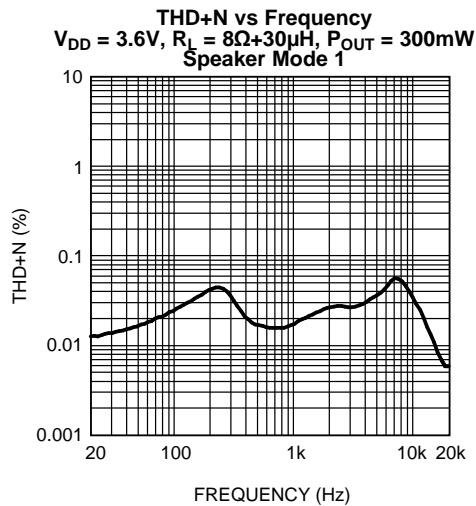

**Figure 5.**

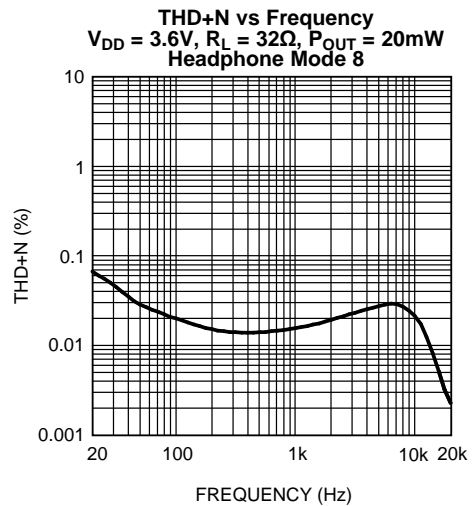

**Figure 6.**

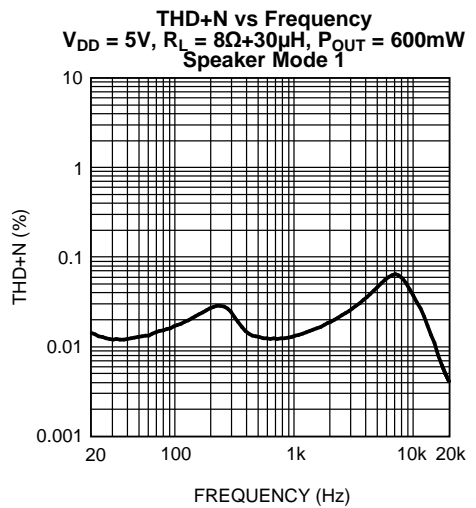

**Figure 7.**

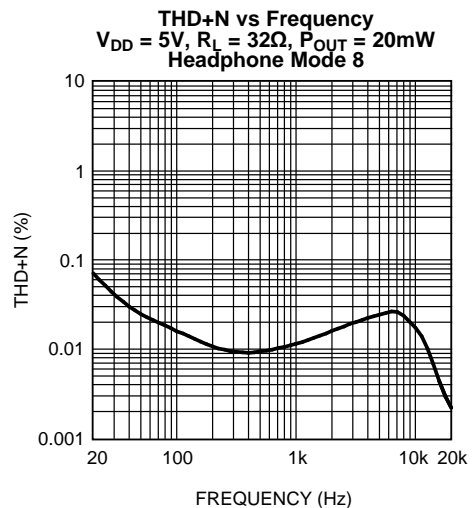

**Figure 8.**

(1) Data taken with BW = 22kHz except where specified.

Typical Performance Characteristics<sup>(1)</sup> (continued)

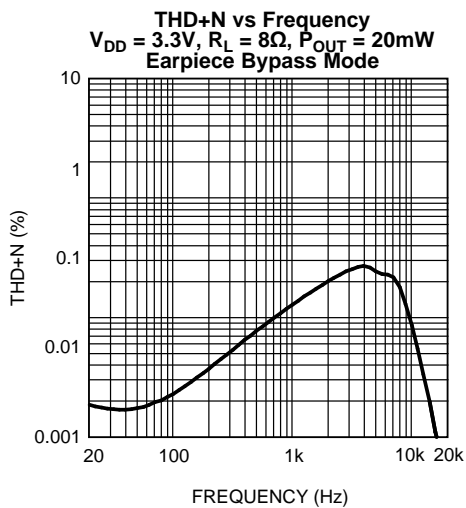

Figure 9.

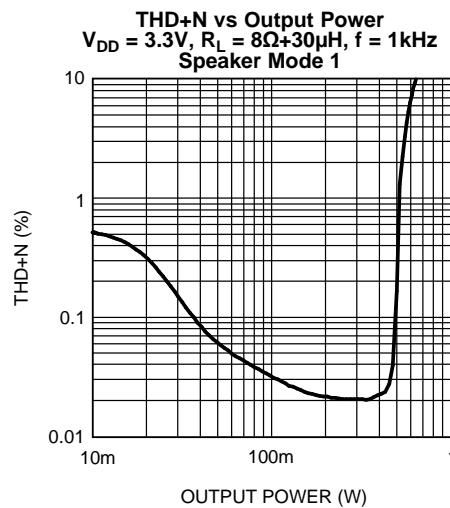

Figure 10.

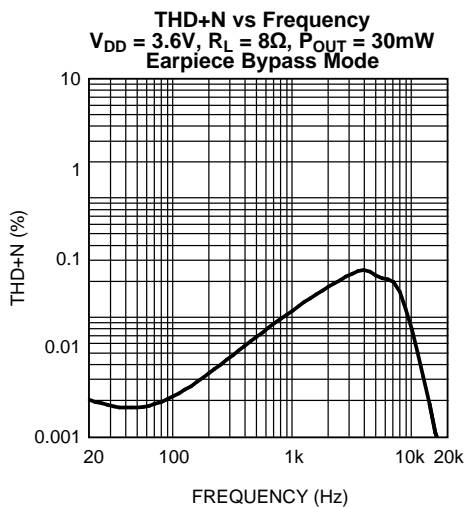

Figure 11.

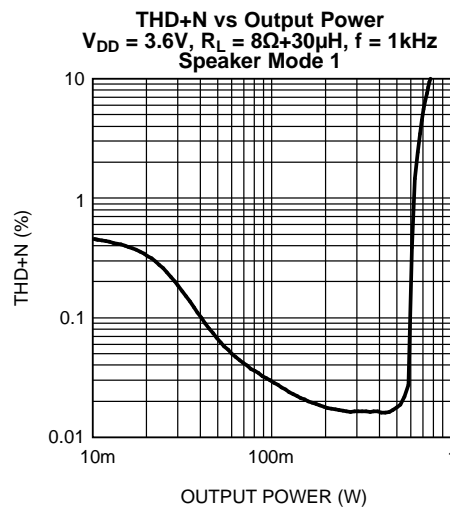

Figure 12.

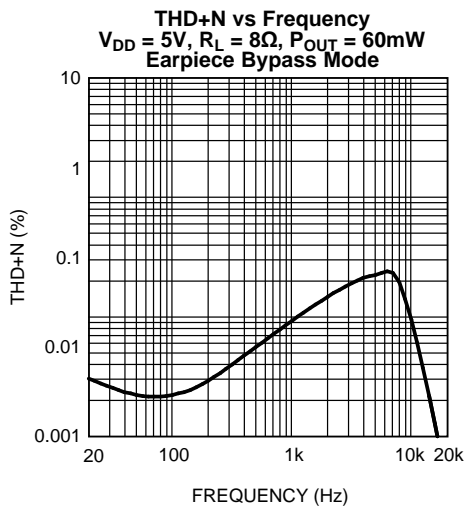

Figure 13.

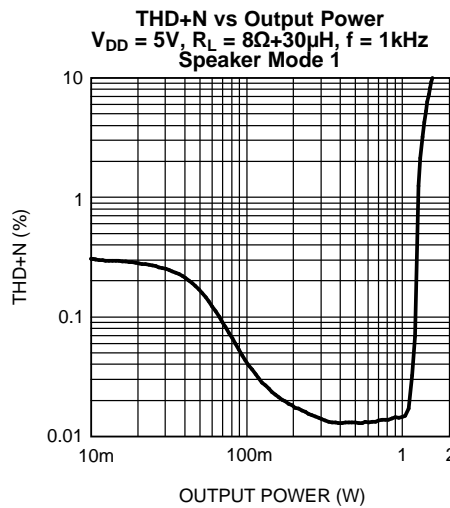

Figure 14.

Typical Performance Characteristics<sup>(1)</sup> (continued)

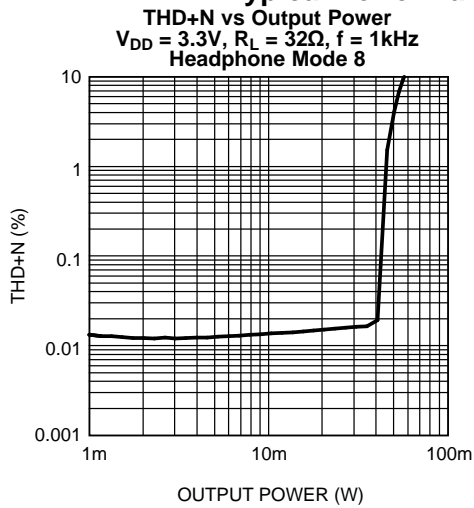

Figure 15.

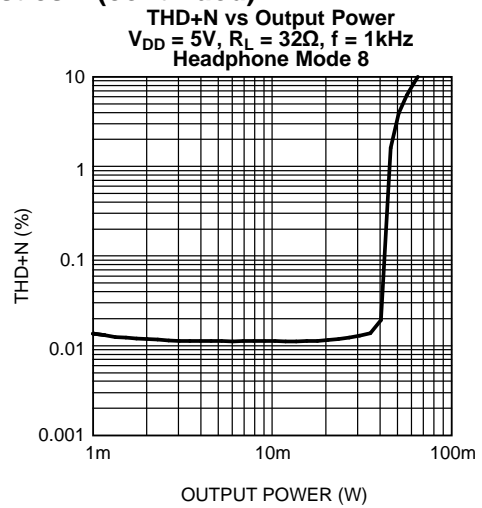

Figure 16.

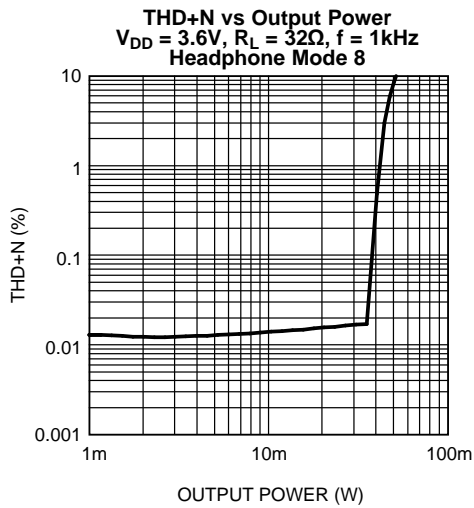

Figure 17.

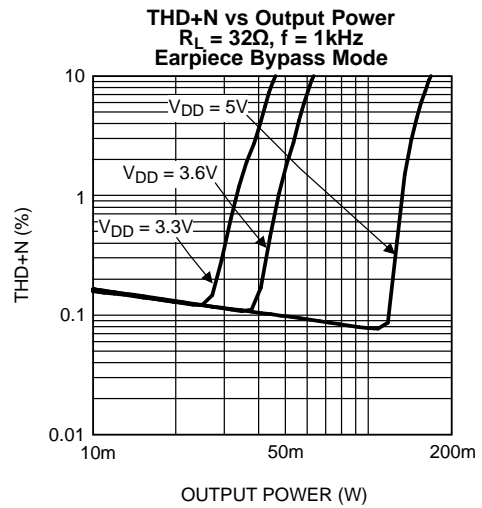

Figure 18.

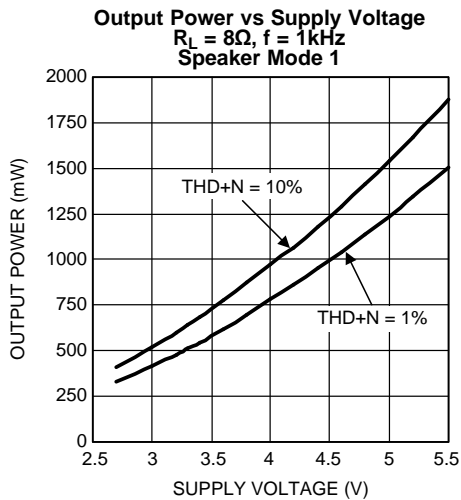

Figure 19.

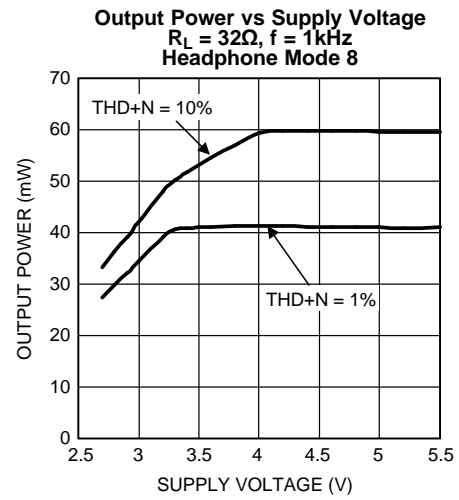

Figure 20.

**Typical Performance Characteristics<sup>(1)</sup> (continued)**

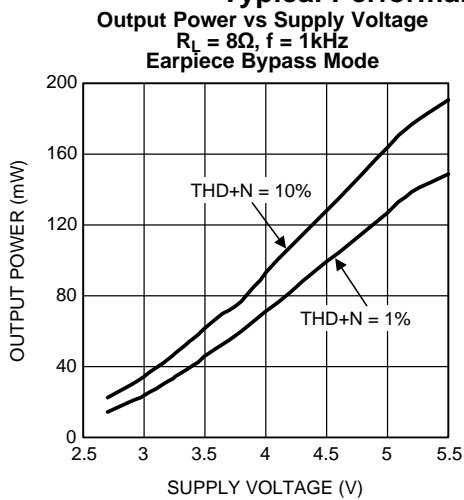

Figure 21.

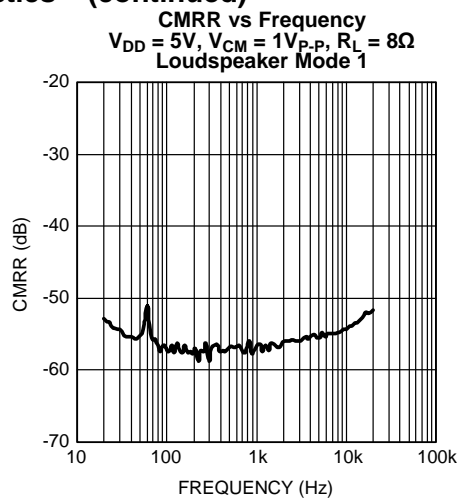

Figure 22.

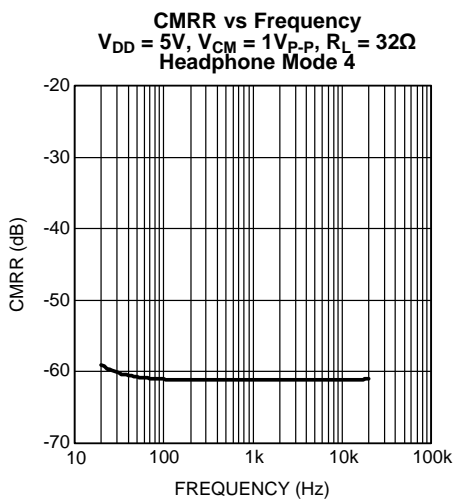

Figure 23.

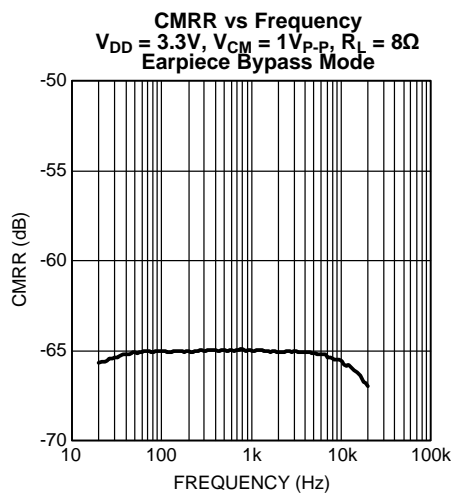

Figure 24.

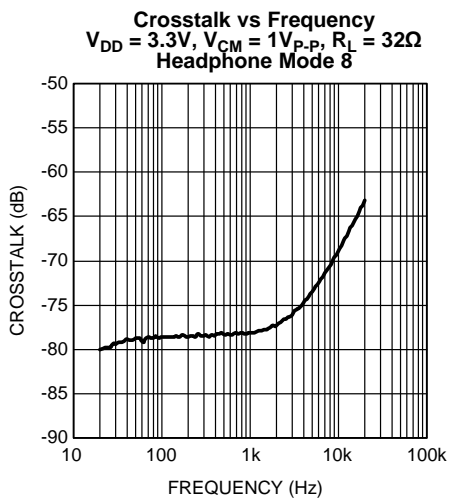

Figure 25.

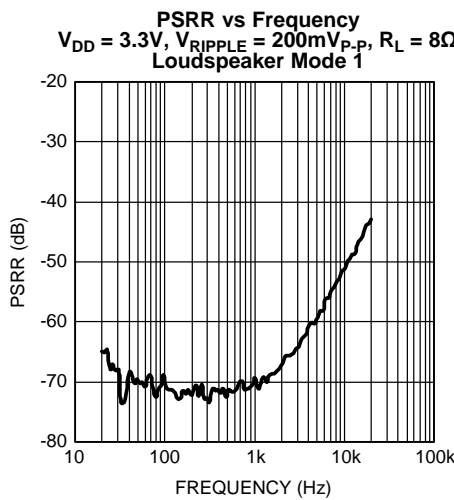

Figure 26.

Typical Performance Characteristics<sup>(1)</sup> (continued)

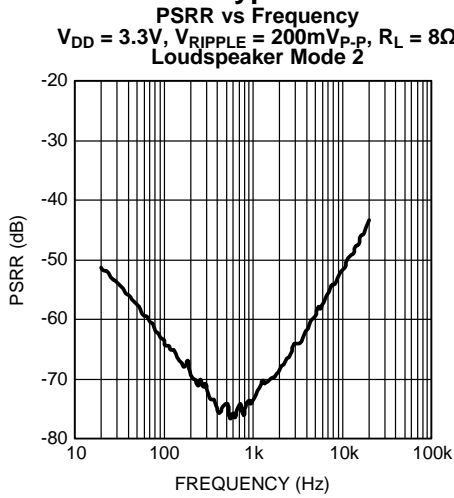

Figure 27.

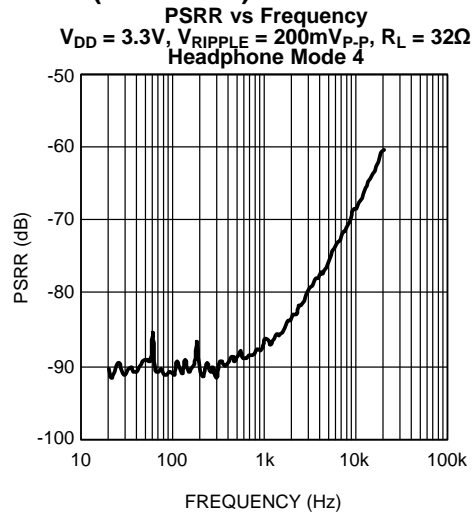

Figure 28.

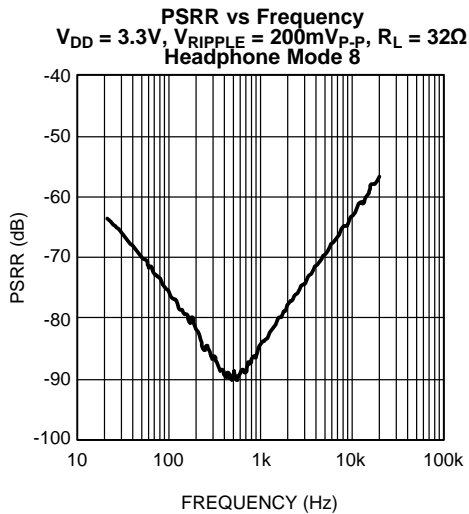

Figure 29.

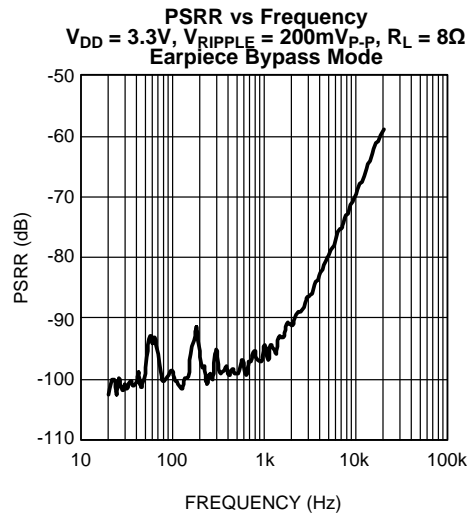

Figure 30.

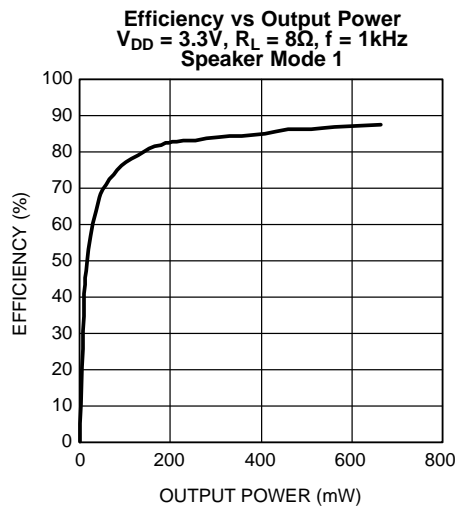

Figure 31.

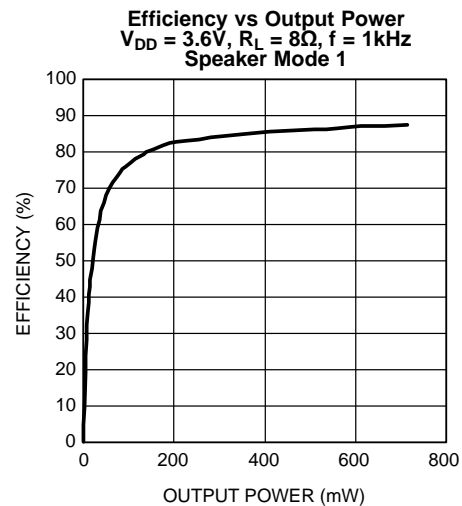

Figure 32.

**Typical Performance Characteristics<sup>(1)</sup> (continued)**

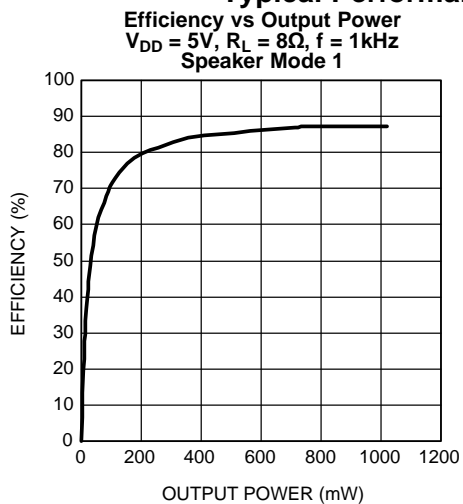

Figure 33.

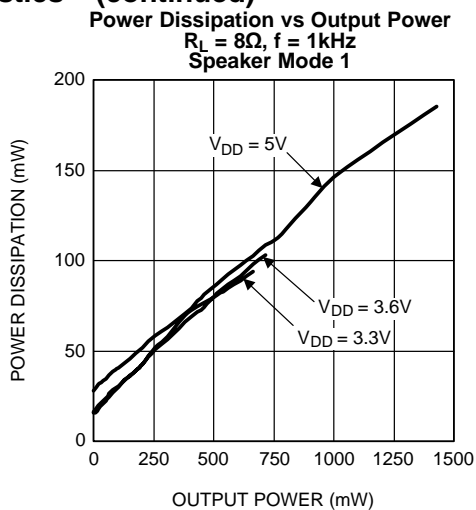

Figure 34.

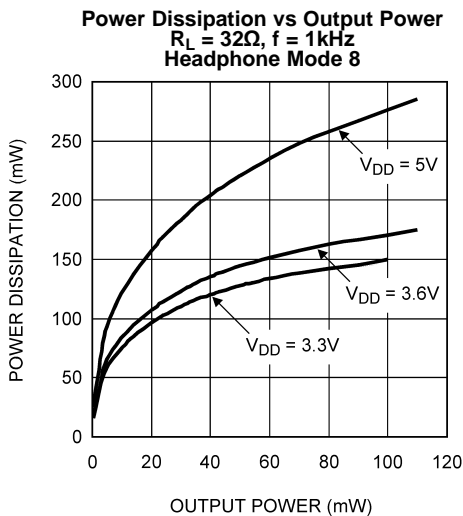

Figure 35.

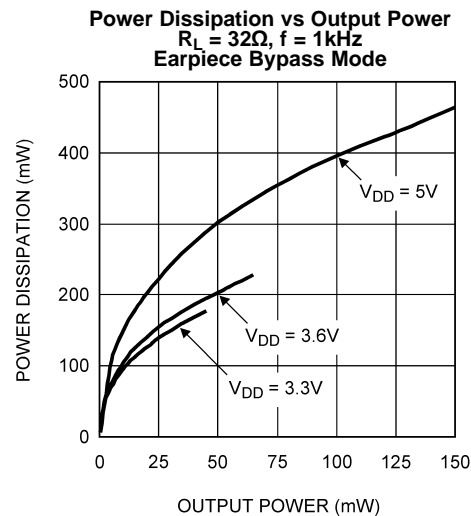

Figure 36.

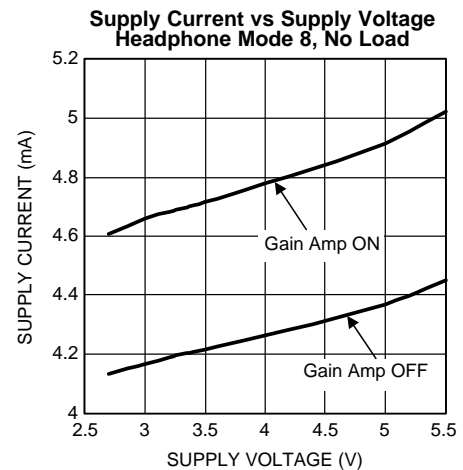

Figure 37.

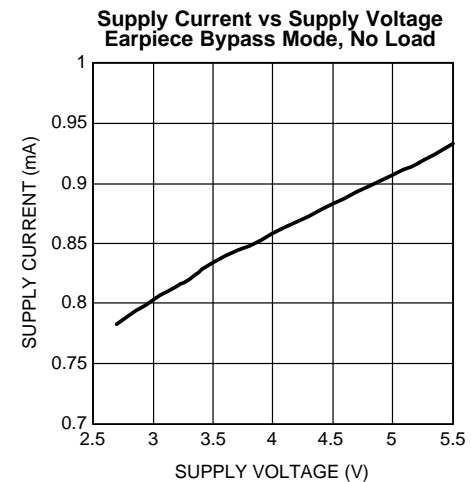

Figure 38.



Typical Performance Characteristics<sup>(1)</sup> (continued)

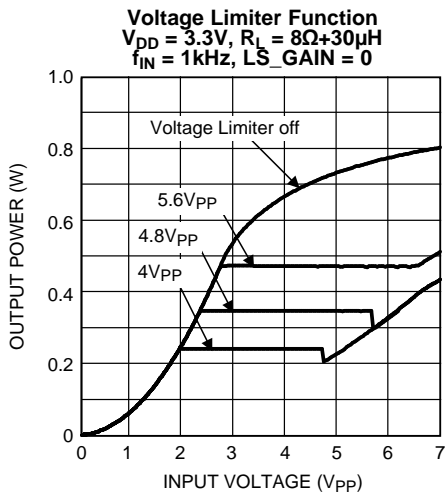

Figure 39.

**Clip Control Levels**  
 $V_{DD} = 3.3V$ ,  $V_{IN} = 8V_{PP}$  Shaped Burst, 1kHz  
 Blue = No Clip Disabled, Gray = Low  
 Light Green = Medium, Green = High, Yellow = Max

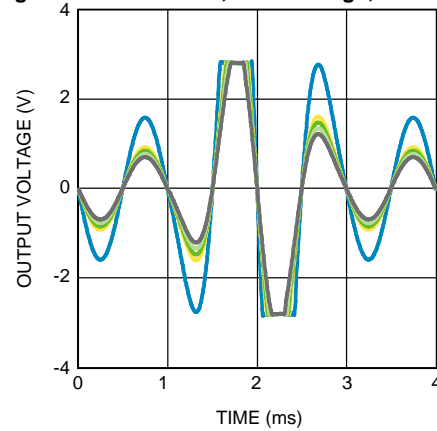

Figure 40.

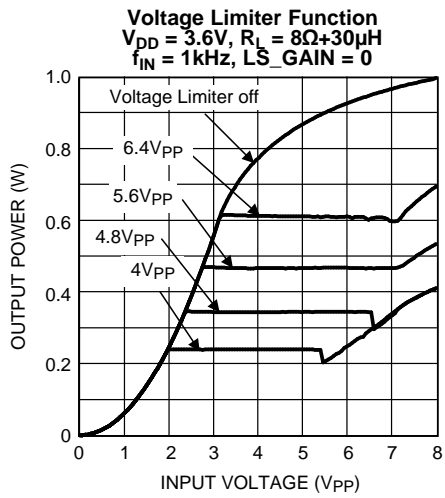

Figure 41.

**Clip Control Levels**  
 $V_{DD} = 3.6V$ ,  $V_{IN} = 8V_{PP}$  Shaped Burst, 1kHz  
 Blue = No Clip Disabled, Gray = Low  
 Light Green = Medium, Green = High, Yellow = Max

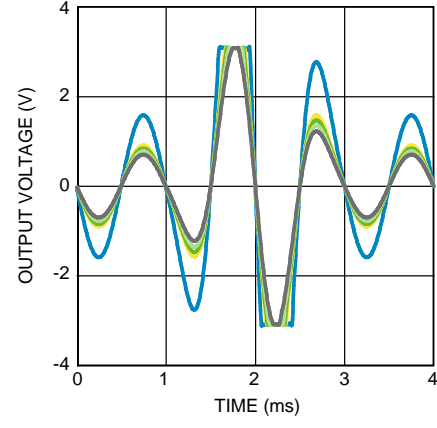

Figure 42.

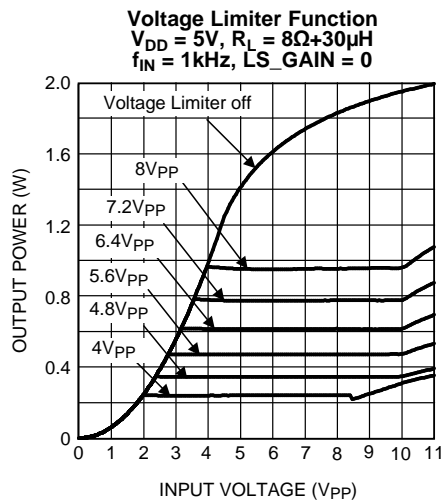

Figure 43.

**Clip Control Levels**  
 $V_{DD} = 5V$ ,  $V_{IN} = 8V_{P-P}$  Shaped Burst, 1kHz  
 Blue = No Clip Disabled, Gray = Low  
 Light Green = Medium, Green = High, Yellow = Max

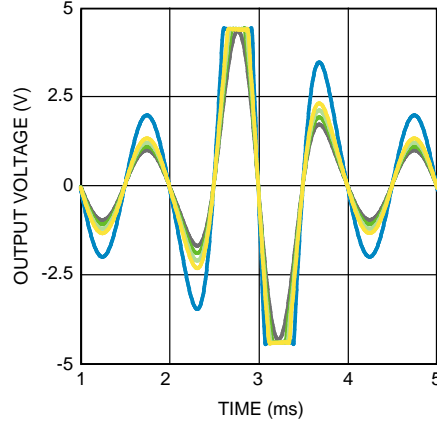

Figure 44.

**Typical Performance Characteristics<sup>(1)</sup> (continued)**

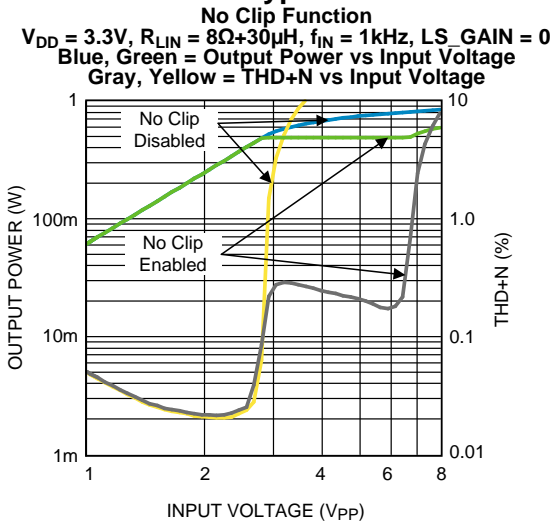

Figure 45.

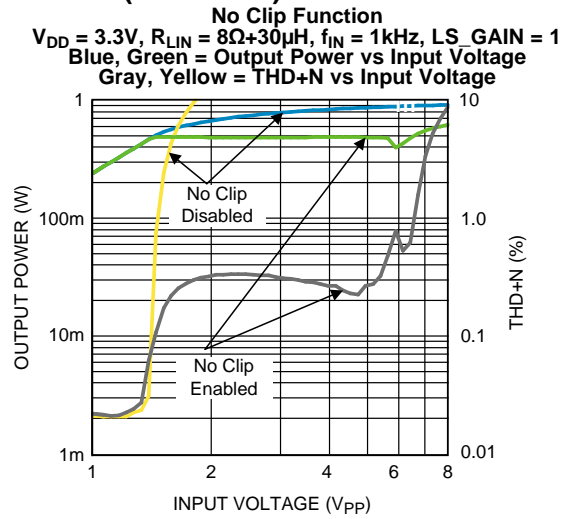

Figure 46.

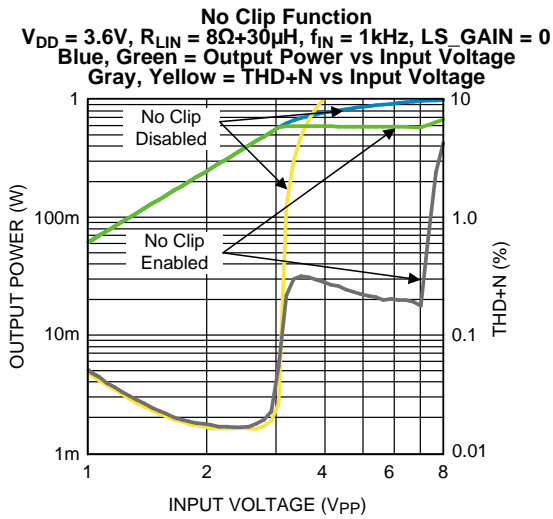

Figure 47.

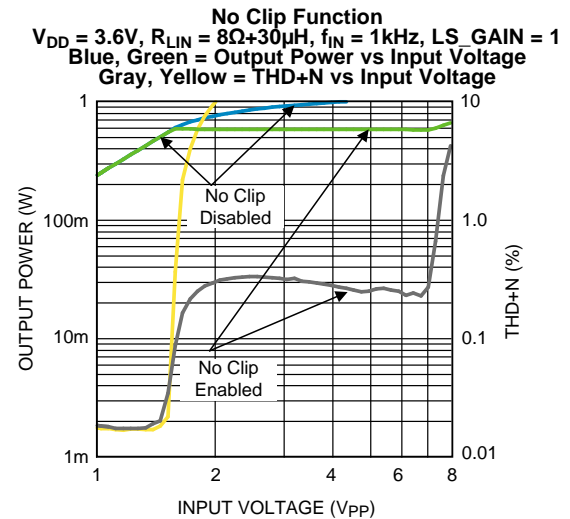

Figure 48.

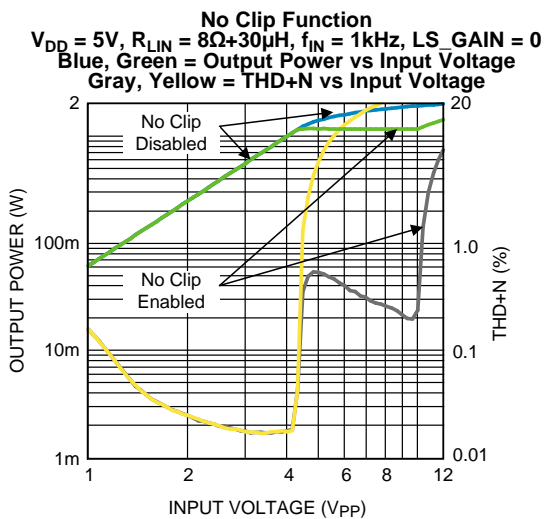

Figure 49.

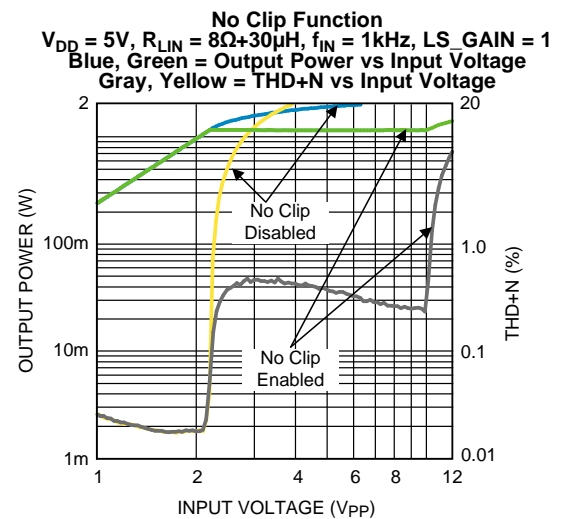

Figure 50.

## APPLICATION INFORMATION

### WRITE-ONLY I<sup>2</sup>C COMPATIBLE INTERFACE

The LM49151 is controlled through an I<sup>2</sup>C compatible serial interface that consists of a serial data line (SDA) and a serial clock (SCL). The SCL and SDA lines are uni-directional write only interface. The LM49151 and the master can communicate at clock rates up to 400kHz. Figure 51 shows the I<sup>2</sup>C interface timing diagram. Data on the SDA line must be stable during the HIGH period of SCL. The LM49151 is a slave-only device, reliant upon the master to generate the SCL signal. Each transmission sequence is framed by a START condition and a STOP condition (Figure 52). Each data word and device address transmitted over the bus is 8 bits long and is always followed by an acknowledge pulse (Figure 53). The LM49151 device address is 11111000.

### I<sup>2</sup>C BUS FORMAT

The bus format for the I<sup>2</sup>C interface is shown in Figure 53. The bus format diagram is broken up into six major sections: The "start" signal is generated by lowering the data signal while the clock signal is HIGH. The start signal will alert all devices attached to the I<sup>2</sup>C bus to check the incoming address against their own address. The 8-bit chip address is sent next, most significant bit first. The data is latched in on the rising edge of the clock. Each address bit must be stable while the clock level is HIGH. After the last bit of the address bit is sent, the master releases the data line HIGH (through a pull-up resistor). Then the master sends an acknowledge clock pulse. If the LM49151 has received the address correctly, then it holds the data line LOW during the clock pulse. If the data line is not held LOW during the acknowledge clock pulse, then the master should abort the rest of the data transfer to the LM49151. The 8 bits of data are sent next, most significant bit first. Each data bit should be valid while the clock level is stable HIGH. After the data byte is sent, the master must check for another acknowledge to see if the LM49151 received the data. If the master has more data bytes to send to the LM49151, then the master can repeat the previous two steps until all data bytes have been sent. The "stop" signal ends the transfer. To signal "stop", the data signal goes HIGH while the clock signal is HIGH. The data line should be held HIGH when not in use.

### I<sup>2</sup>C INTERFACE POWER SUPPLY PIN (I<sup>2</sup>CV<sub>DD</sub>)

The LM49151's I<sup>2</sup>C interface is powered up through the I<sup>2</sup>CV<sub>DD</sub> pin. The LM49151 I<sup>2</sup>C interface operates at a voltage level set by the I<sup>2</sup>CV<sub>DD</sub> pin which can be set independent to that of the main power supply pin V<sub>DD</sub>. This is ideal whenever logic levels for the I<sup>2</sup>C interface are dictated by a microcontroller or microprocessor that is operating at a lower supply voltage than the main battery of a portable system.

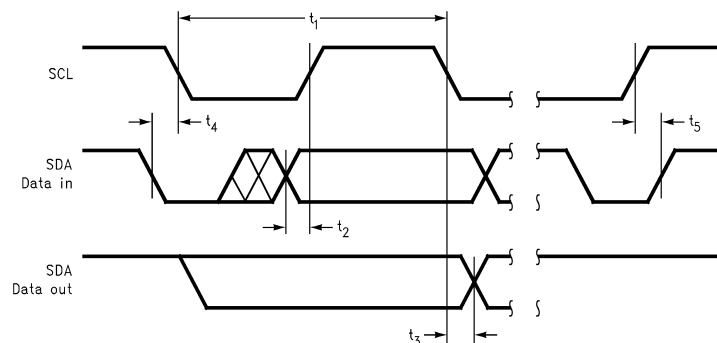

Figure 51. I<sup>2</sup>C Timing Diagram

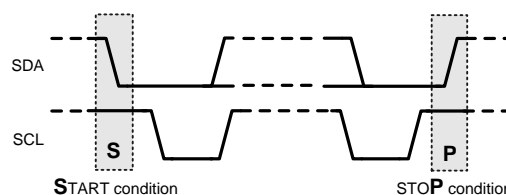

Figure 52. Start and Stop Diagram

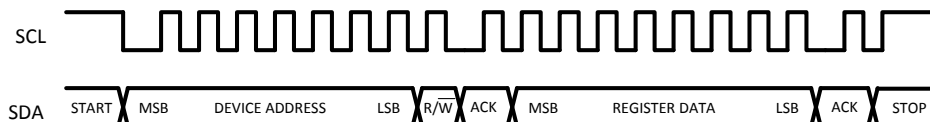

Figure 53. Example I<sup>2</sup>C Write Cycle

### DEVICE ADDRESS REGISTER

Table 1. Device Address

	B7	B6	B5	B4	B3	B2	B1	B0 ( $\bar{W}$ )
Device Address	1	1	1	1	1	0	0	0

### I<sup>2</sup>C CONTROL REGISTER

Table 2. I<sup>2</sup>C Control

	B7	B6	B5	B4	B3	B2	B1	B0
Shutdown Control	0	0	0	GAMP_SD	HPR_SD	I <sup>2</sup> CV <sub>DD</sub> _SD	TURN_ON_TIME	PWR_ON
Mode Control	0	0	1	EP_BYPASS	MODE_CONTROL			
Voltage Limit Control	0	1	0	ATTACK_TIME		VOLTAGE_LEVEL		
No Clip Control	0	1	1	RELEASE_TIME		OUTPUT_CLIP_CONTROL		
Gain Control	1	0	0	INPUT_MUTE	LS_GAIN	HP_GAIN		
Mono Volume Control	1	0	1	MONO_VOL				
Stereo Volume Control	1	1	0	STEREO_VOL				
SS Control	1	1	1	0	0	0	0	SS_EN

### SHUTDOWN CONTROL REGISTER

This register is used to control shutdown operation of the device.

Table 3. Shutdown Control

Bit	Name	Value	Description
B0	PWR_ON	This enables or disables the device.	
		PWR_ON	Status
		0	Device disabled
		1	Device enabled
B1	TURN_ON_TIME	This control the turn on time of the device.	
		TURN_ON_TIME	Status
		0	Normal turn on time (27ms)
		1	Fast turn on time (15ms)
B2	I <sup>2</sup> CV <sub>DD</sub> _SD	I <sup>2</sup> CV <sub>DD</sub> _SD	Status
		0	I <sup>2</sup> CV <sub>DD</sub> acts as an active low RESET input. If I <sup>2</sup> CV <sub>DD</sub> drops below 1.1V, the device resets and the I <sup>2</sup> C registers are restored to their default state.
		1	Normal Operation. I <sup>2</sup> CV <sub>DD</sub> voltage does not reset the device.
B3	HPR_SD	This disables the right headphone output.	
		HPR_SD	Status
		0	Normal Operation
		1	Headphone right disabled

**Table 3. Shutdown Control (continued)**

Bit	Name	Value	Description
B4	GAMP_SD	This disables the gain amplifiers that are not in use to minimize I <sub>DD</sub> . This setting is recommended for output modes 1, 2, 4, 5, 8, 10.	
		GAMP_SD	Status
		0	Normal operation
		1	Disable the unused gain amplifiers

## MODE CONTROL REGISTER

This register is used to control shutdown operation of the device.

**Table 4. Output Mode Selection (see legend below<sup>(1)</sup>)**

Bits	Field	Description				
B3:B0	MODE_CONTROL	This set the different mixers output modes.				
		Mode_Control	Mode	Loudspeaker	Headphone Right	Headphone Left
		0000	0	SD	SD	SD
		0001	1	G <sub>M</sub> x M	SD	SD
		0010	2	2 x (G <sub>L</sub> x L + G <sub>R</sub> x R)	SD	SD
		0011	3	2 x (G <sub>L</sub> x L + G <sub>R</sub> x R) + G <sub>M</sub> x M	SD	SD
		0100	4	SD	G <sub>M</sub> x M/2	G <sub>M</sub> x M/2
		0101	5	G <sub>M</sub> x M	G <sub>M</sub> x M/2	G <sub>M</sub> x M/2
		0110	6	2 x (G <sub>L</sub> x L + G <sub>R</sub> x R)	G <sub>M</sub> x M/2	G <sub>M</sub> x M/2
		0111	7	2 x (G <sub>L</sub> x L + G <sub>R</sub> x R) + G <sub>M</sub> x M	G <sub>M</sub> x M/2	G <sub>M</sub> x M/2
		1000	8	SD	G <sub>R</sub> x R	G <sub>L</sub> x L
		1001	9	G <sub>M</sub> x M	G <sub>R</sub> x R	G <sub>L</sub> x L
		1010	10	2 x (G <sub>L</sub> x L + G <sub>R</sub> x R)	G <sub>R</sub> x R	G <sub>L</sub> x L
		1011	11	2 x (G <sub>L</sub> x L + G <sub>R</sub> x R) + G <sub>M</sub> x M	G <sub>R</sub> x R	G <sub>L</sub> x L
		1100	12	SD	G <sub>R</sub> x R + G <sub>M</sub> x M/2	G <sub>L</sub> x L + G <sub>M</sub> x M/2
		1101	13	G <sub>M</sub> x M	G <sub>R</sub> x R + G <sub>M</sub> x M/2	G <sub>L</sub> x L + G <sub>M</sub> x M/2
		1110	14	2 x (G <sub>L</sub> x L + G <sub>R</sub> x R)	G <sub>R</sub> x R + G <sub>M</sub> x M/2	G <sub>L</sub> x L + G <sub>M</sub> x M/2
1111	15	2 x (G <sub>L</sub> x L + G <sub>R</sub> x R) + G <sub>M</sub> x M	G <sub>R</sub> x R + G <sub>M</sub> x M/2	G <sub>L</sub> x L + G <sub>M</sub> x M/2		
B4	EP_BYPASS	This makes the loudspeaker and headphone amplifiers into shutdown mode and enables receiver bypass path.				
		0	Normal output mode operation			
		1	Enable the receiver bypass path			

- (1) M: Mono differential input  
 R: Right channel stereo input  
 L: Left channel stereo input  
 SD: Shutdown  
 G<sub>M</sub>: Differential input gain path  
 G<sub>R</sub>: Right channel input gain path  
 G<sub>L</sub>: Left channel input gain path

## VOLTAGE LIMIT CONTROL REGISTER

This register is used to control output voltage limiter settings and attack time of the automatic level circuit:

**Table 5. Voltage Limit Control**

Bits	Field	Description	
B2:B0	VOLTAGE_LEVEL	This sets the output voltage limit level.	
		000	Voltage limit disabled
		001	$V_{TH(VLIM)} = 4V_{P-P}$
		010	$V_{TH(VLIM)} = 4.8V_{P-P}$
		011	$V_{TH(VLIM)} = 5.6V_{P-P}$
		100	$V_{TH(VLIM)} = 6.4V_{P-P}$
		101	$V_{TH(VLIM)} = 7.2V_{P-P}$
		110	$V_{TH(VLIM)} = 8V_{P-P}$
		111	Voltage limit disabled
B4:B3	ATTACK_TIME	This sets the Attack time of automatic level control circuit. It is based on characterization data and $C_{SET} = 0.1\mu F$ (see <a href="#">ATTACK TIME</a> section)	
		00	0.75ms
		01	1ms
		10	1.5ms
		11	2ms

## NO CLIP CONTROL REGISTER

This register is used to control output clip control settings and release time of the automatic level circuit:

**Table 6. No Clip Control**

Bits	Field	Description	
B2:B0	OUTPUT_CLIP_CONTROL	This sets the output clip limit level.	
		000	No Clip disabled, output clip control disabled
		001	No Clip enabled, output clip control disabled
		010	Low
		011	Medium
		100	High
		101	Max
		110	No Clip enabled, output clip control disabled
111	No Clip enabled, output clip control disabled		
B4:B3	RELEASE_TIME	This sets the release time of automatic level control circuit. It is based on characterization data and $C_{SET} = 0.1\mu F$ (see <a href="#">RELEASE TIME</a> section)	
		00	1s
		01	0.8s
		10	0.65s
		11	0.4s

## GAIN CONTROL REGISTER

This register is used to control gain level for on the outputs:

**Table 7. Gain Control**

Bits	Field	Description	
B2:B0	HP_GAIN	This sets the headphone output gain level.	
		000	0dB
		001	-1.5dB
		010	-3dB
		011	-6dB
		100	-9dB
		101	-12dB
		110	-15dB
		111	-18dB
B3	LS_GAIN	This sets the loudspeaker output gain level.	
		0	12dB
		1	18dB
B4	INPUT_MUTE	This sets the inputs into lower power mute mode.	
		0	Normal operation
		1	Device inputs are in mute mode

## VOLUME CONTROL REGISTER

These registers are used to control output volume control levels for Loudspeaker and Headphone:

**Table 8. LS GAIN / HP GAIN**

Bits	Field	Description	
B4:B0	MONO_VOL STEREO_VOL	This programs the Earpiece, Loudspeaker, and Headphone volume level.	
		VOL	Level (dB)
		00000	MUTE
		00001	-46.5
		00010	-40.5
		00011	-34.5
		00100	-30
		00101	-27
		00110	-24
		00111	-21
		01000	-18
		01001	-15
		01010	-13.5
		01011	-12
		01100	-10.5
		01101	-9
		01110	-7.5
		01111	-6
		10000	-4.5
		10001	-3
		10010	-1.5
		10011	0
		10100	1.5
		10101	3
		10110	4.5
		10111	6
		11000	7.5
		11001	9
11010	10.5		
11011	12		
11100	13.5		
11101	15		
11110	16.5		
11111	18		

## SPREAD SPECTRUM CONTROL REGISTER

This register controls the spread spectrum mode of the class D amplifier:

**Table 9. SS Control**

Bits	Field	Description	
B0	SS_ENB	This sets the spread spectrum mode of the Class D amplifier.	
		0	Spread Spectrum Disabled
		1	Spread Spectrum Enabled



## DIFFERENTIAL AMPLIFIER EXPLANATION

The LM49151 features a differential input stage, which offers improved noise rejection compared to a single-ended input amplifier. Because a differential input amplifier amplifies the difference between the two input signals, any component common to both signals is cancelled. An additional benefit of the differential input structure is the possible elimination of the DC input blocking capacitors. Since the DC component is common to both inputs, and thus cancelled by the amplifier, the LM49151 can be used without input coupling capacitors when configured with a differential input signal.

## INPUT MIXER/MULTIPLEXER

The LM49151 includes a comprehensive mixer multiplexer controlled through the I<sup>2</sup>C interface. The mixer/multiplexer allows any input combination to appear on any output of LM49151. Multiple input paths can be selected simultaneously. Under these conditions, the selected inputs are mixed together and output on the selected channel. [Table 5](#) (MODE CONTROL) shows how the input signals are mixed together for each possible input selection.

## SHUTDOWN FUNCTION

The LM49151 features the following shutdown controls: Bit B4 (GAMP\_SD) of the SHUTDOWN CONTROL register controls the gain amplifiers. When GAMP\_SD = 1, it disables the gain amplifiers that are not in use. For example, in Modes 1, 4 and 5, the Mono inputs are in use, so the Left and Right input gain amplifiers are disabled, causing the I<sub>DD</sub> to be minimized. Bit B0 (PWR\_ON) of the SHUTDOWN CONTROL register is the global shutdown control for the entire device. Set PWR\_ON = 0 for normal operation. PWR\_ON = 1 overrides any other shutdown control bit.

## CLASS D AMPLIFIER

The LM49151 features a mono class D audio power amplifier with a filterless modulation scheme that reduces external component count, conserving board space and reducing system cost. With no signal applied, the outputs (LSOUT+ and LSOUT-) switch between VDD and GND with 50% duty cycle, in phase, causing the two outputs to cancel. This cancellation results in no net voltage across the speaker, thus there is no current to the load in the idle state.

With an input signal applied, the duty cycle (pulse width) of the class D output changes. For increasing output voltage, the duty cycle of LSOUT+ increases, while the duty cycle of LSOUT- decreases. For decreasing output voltages, the converse occurs. The difference between the two pulse widths yields the differential output voltage.

## ENHANCED EMISSIONS SUPPRESSION (E<sup>2</sup>S)

The LM49151 class D amplifier features Texas Instruments' patent-pending E<sup>2</sup>S system that reduces EMI, while maintaining high quality audio reproduction and efficiency. The E<sup>2</sup>S system features selectable spread spectrum and advanced edge rate control (ERC). The LM49151 class D ERC greatly reduces the high frequency components of the output square waves by controlling the output rise and fall times, slowing the transitions to reduce RF emissions, while maximizing THD+N and efficiency performance.

## FIXED FREQUENCY

The LM49151 class D amplifier features two modulation schemes, a fixed frequency mode and a spread spectrum mode. Select the fixed frequency mode by setting bit B0 (SS\_EN) of the SS CONTROL register to 0. In fixed frequency mode, the loudspeaker outputs switch at a constant 300kHz. The output spectrum consists of the 300kHz fundamental and its associated harmonics.

## SPREAD SPECTRUM

The selectable spread spectrum mode minimizes the need for output filters, ferrite beads or chokes. In spread spectrum mode, the switching frequency varies randomly by 30% about a 300kHz center frequency, reducing the wideband spectral content, improving EMI emission radiated by the speaker and associated cables and traces. Where a fixed frequency class D exhibits large amounts of spectral energy at multiples of the switching frequency, the spread spectrum architecture spreads that energy over a larger bandwidth. The cycle-to-cycle variation of the switching period does not affect the audio reproduction, efficiency, or PSRR. Set bit B0 (SS\_EN) of the SS CONTROL register to 1 to enable spread spectrum mode.

## GROUND REFERENCED HEADPHONE AMPLIFIER

The LM49151 features a low noise inverting charge pump that generates an internal negative supply voltage. This allows the headphone outputs to be biased about GND instead of a nominal DC voltage, like traditional headphone amplifiers. Because there is no DC component, the large DC blocking capacitors (typically 220 $\mu$ F) are not necessary. The coupling capacitors are replaced by two small ceramic charge pump capacitors, saving board space and cost. Eliminating the output coupling capacitors also improves low frequency response. In traditional headphone amplifiers, the headphone impedance and the output capacitor form a high-pass filter that not only blocks the DC component of the output, but also attenuates low frequencies, impacting the bass response. Because the LM49151 does not require the output coupling capacitors, the low frequency response of the device is not degraded by external components. In addition to eliminating the output coupling capacitors, the ground referenced output nearly doubles the available dynamic range of the LM49151 headphone amplifiers when compared to a traditional headphone amplifier operating from the same supply voltage.

## EARPIECE (EP) BYPASS

When B4 of MODE\_CONTROL register is set to 1, earpiece amplifier is enabled and differential inputs are passed down to speaker outputs. This in turn disables the class D amplifier.

## AUTOMATIC LIMITER CONTROL (ALC)

When enabled, the ALC continuously monitors and adjusts the gain of the loudspeaker amplifier signal path if necessary. The ALC serves two functions: voltage limiter/speaker protection and output clip prevention (No-Clip) with four clip controls levels. The voltage limiter/speaker protection prevents an output overload condition by maintaining the loudspeaker output signal below a preset amplitude (See [VOLTAGE LIMITER](#) section). The No Clip feature monitors the output signal and maintains audio quality by preventing the loudspeaker output from exceeding the amplifier's headroom (see [NO CLIP/OUTPUT CLIP CONTROL](#) section). The voltage limiter thresholds, clip control levels, attack and release times are configured through the I<sup>2</sup>C interface.

## VOLTAGE LIMITER

The voltage limiter function of the ALC monitors and prevents the audio signal from exceeding the voltage limit threshold ([Figure 54](#)). The voltage limit threshold ( $V_{TH(VLIM)}$ ) is set by bits B2:B0 in the Voltage Limit Threshold Register (see [Table 6](#)). Although the ALC reduces the gain of the speaker path to maintain the audio signal below the voltage limit threshold, it is still possible to overdrive the speaker output in which case loudspeaker output will exceed the voltage limit threshold and cause clipping on the output, and speaker damage is possible. Please see the [ALC HEADROOM](#) section for further details.

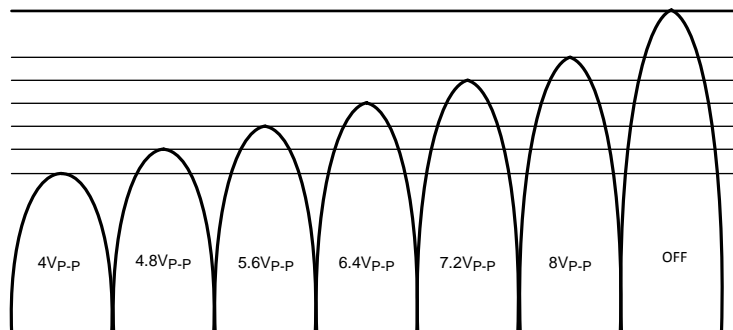

**Figure 54. Voltage Limit Output Level**

## NO CLIP/OUTPUT CLIP CONTROL

The LM49151 No Clip circuitry detects when the loudspeaker output is near clipping and reduces the signal gain to prevent output clipping and preserve audio quality ([Figure 55](#)). Although the ALC reduces the gain of the speaker path to prevent output clipping, it is still possible to overdrive the speaker output. Please see the [ALC HEADROOM](#) section for further details.

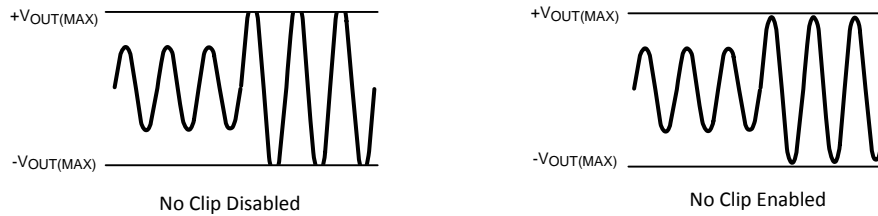

Figure 55. No Clip Function

The LM49151 also features an output clip control that allows a certain amount of clipping at the output in order to increase the loudspeaker output power. The clip level is set by B2:B0 in the No Clip Control Register (see Table 7). The clip control works by allowing the output to enter clipping before the ALC turns on and maintains the output level. The clip control has four levels: low, medium, high and max. The low and max clip level control settings give the lowest distortion and highest distortion respectively on the output (see Figure 56). The actual output level of the device will depend upon the supply voltage, and the output power will depend upon the load impedance.

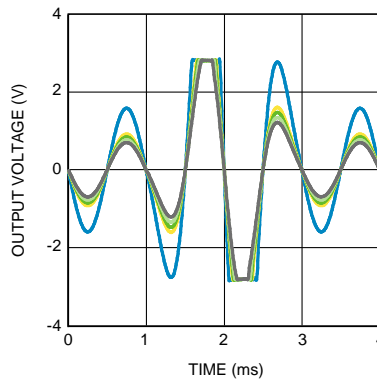

Figure 56. Clip Control Levels  
 $V_{DD} = 3.3V$ ,  $V_{IN} = 8V_{PP}$  Shaped Burst, 1kHz  
 Blue = No Clip Disabled, Gray = Low, Light Green = Medium  
 Green = High, Yellow = Max

## ALC HEADROOM

When either voltage limiter or no clip is enabled, it is still possible to drive LM49151 into clipping by overdriving the input volume stage of the signal path beyond its output dynamic range. In this case, clipping occurs at the input volume stage, and although ALC is active, the gain reduction will have no effect on the output clipping. The maximum input that can safely pass through the input volume stage can be calculated by following formula:

$$V_{IN} \leq \frac{V_{DD}}{A_v \text{ (volume gain)}} \quad (1)$$

So in the case of 0 dB volume gain, audio input has to be less than  $V_{DD}$  for both voltage limiter or No clip settings.

When voltage limiter is enabled, ALC can reach its max attenuation for lower voltage limit levels as shown in the Figure 57. Typically, after the ALC started working, with 6 dB of audio input change ALC is well within its regulation. Voltage limiter Input headroom can be increased by switching to the LS\_GAIN to 18dB in the Gain Control Register (see Table 7).

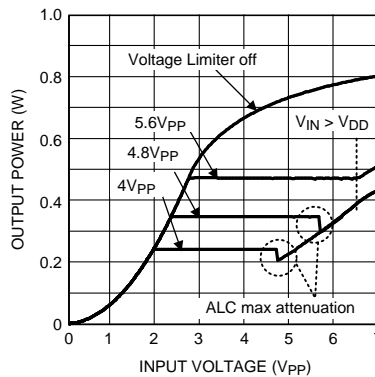

**Figure 57. Voltage Limiter Function**  
 $V_{DD} = 3.3V$ ,  $R_L = 8\Omega + 30\mu H$   
 $f_{IN} = 1kHz$ ,  $LS\_GAIN = 0$

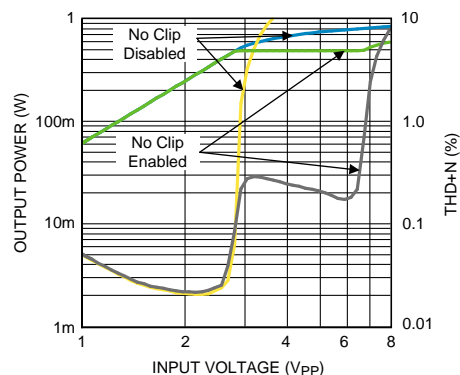

**Figure 58. No Clip Function**  
 $V_{DD} = 3.3V$ ,  $R_L = 8\Omega + 30\mu H$   
 $f_{IN} = 1kHz$ ,  $LS\_GAIN = 0$   
**Blue, Green = Output Power vs Input Voltage**  
**Gray, Yellow = THD+N vs Input Voltage**

When No Clip is enabled, class D speaker output reduces when it's about to enter clipping region and power stay constant as long as  $V_{IN}$  is less than  $V_{DD}$  for 0 dB volume gain (see Figure 58). For example, in the case of  $V_{DD} = 3.3V$ , there is a 6 dB of headroom for the change in input. Please see the ALC typical performance curves for additional plots relating to different supply voltages and  $LS\_GAIN$  settings for specific application parameters.

**ATTACK TIME**

Attack time ( $t_{ATK}$ ) is the time it takes for the gain to be reduced by 6dB ( $LS\_GAIN=0$ ) once the audio signal exceeds the ALC threshold. Fast attack times allow the ALC to react quickly and prevent transients such as symbol crashes from being distorted. However, fast attack times can lead to volume pumping, where the gain reduction and release becomes noticeable, as the ALC cycles quickly. Slower attack times cause the ALC to ignore the fast transients, and instead act upon longer, louder passages. Selecting an attack time that is too slow can lead to increased distortion in the case of the No Clip function, and possible output overload conditions in the case of the Voltage limiter. The attack time is set by a combination of the value of  $C_{SET}$  and the attack time coefficient as given by Equation 2:

$$t_{ATK} = 20k\Omega C_{SET} / \alpha_{ATK} \quad (s) \tag{2}$$

Where  $\alpha_{ATK}$  is the attack time coefficient (Table 10) set by bits B4:B3 in the Voltage Limit Control Register (see Table 7). The attack time coefficient allows the user to set a nominal attack time. The internal 20kΩ resistor is subject to temperature change, and it has tolerance between -11% to +20%.

**Table 10. Attack Time Coefficient**

B5	B4	$\alpha_{ATK}$
0	0	2.667
0	1	2
1	0	1.333
1	1	1

## RELEASE TIME

Release time ( $t_{RL}$ ) is the time it takes for the gain to return from 6dB (LS\_GAIN=0) to its normal level once the audio signal returns below the ALC threshold. A fast release time allows the ALC to react quickly to transients, preserving the original dynamics of the audio source. However, similar to a fast attack time, a fast release time contributes to volume pumping. A slow release time reduces the effect of volume pumping. The release time is set by a combination of the value of  $C_{SET}$  and release time coefficient as given by [Equation 3](#):

$$t_{RL} = 20M\Omega C_{SET} / \alpha_{RL} \quad (s) \quad (3)$$

where  $\alpha_{RL}$  is the release time coefficient ([Table 11](#)) set by bits B4:B3 in the No Clip Control Register. The release time coefficient allows the user to set a nominal release time. The internal 20M $\Omega$  is subject to temperature change, and it has tolerance between -11% to +20%.

**Table 11. Release Time Coefficient**

B5	B4	$\alpha_{RL}$
0	0	2
0	1	2.5
1	0	3
1	1	5

## PROPER SELECTION OF EXTERNAL COMPONENTS

### ALC Timing ( $C_{SET}$ ) Capacitor Selection

The recommended range value of  $C_{SET}$  is between .01 $\mu$ F to 1 $\mu$ F. Lowering the value below .01 $\mu$ F can increase the attack time but LM49151 ALC ability to regulate its output can be disrupted and approaches the hard limiter circuit. This in turn increases the THD+N and audio quality will be severely affected.

### Charge Pump Capacitor Selection

Use low ESR ceramic capacitors (less than 100m $\Omega$ ) for optimum performance.

### Charge Pump Flying Capacitor ( $C_1$ )

The flying capacitor ( $C_1$ ), see [Figure 1](#), affects the load regulation and output impedance of the charge pump. A  $C_1$  value that is too low results in a loss of current drive, leading to a loss of amplifier headroom. A higher valued  $C_1$  improves load regulation and lowers charge pump output impedance to an extent. Above 2.2 $\mu$ F, the RDS(ON) of the charge pump switches and the ESR of  $C_1$  and  $CPV_{SS}$  dominate the output impedance. A lower value capacitor can be used in systems with low maximum output power requirements.

### Charge Pump Hold Capacitor ( $CPV_{SS}$ )

The value and ESR of the hold capacitor ( $CPV_{SS}$ ) directly affects the ripple on  $CPV_{SS}$ . (see [Figure 1](#)) Increasing the value of  $CPV_{SS}$  reduces output ripple. Decreasing the ESR of  $CPV_{SS}$  reduces both output ripple and charge pump output impedance. A lower value capacitor can be used in systems with low maximum output power requirements.

## Input Capacitor Selection

Input capacitors may be required for some applications, or when the audio source is single-ended. Input capacitors block the DC component of the audio signal, eliminating any conflict between the DC component of the audio source and the bias voltage of the LM49151. The input capacitors create a high-pass filter with the input resistors  $R_{IN}$ . The -3dB point of the high-pass filter is found using [Equation 4](#) below.

$$f = 1 / 2\pi R_{IN} C_{IN} \quad (\text{Hz}) \quad (4)$$

Where the value of  $R_{IN}$  is given in the Electrical Characteristics Table.

High-pass filtering the audio signal helps protect the speakers. When the LM49151 is using a single-ended source, power supply noise on the ground is seen as an input signal. Setting the high-pass filter point above the power supply noise frequencies, 217Hz in a GSM phone, for example, filters out the noise such that it is not amplified and heard on the output. Capacitors with a tolerance of 10% or better are recommended for impedance matching and improved CMRR and PSRR.

## Revision History

Rev	Date	Description
0.01	02/12/09	Initial PDF.
0.02	02/23/09	Text edits.
0.03	03/05/09	Text edits.
0.04	03/24/09	Text edits and added more graphs.
0.05	03/25/09	Cosmetic fixes.
0.06	03/26/09	Released 1–4 pages.
0.07	04/01/09	Text edits.
0.08	04/09/09	Text edits and edited the Ordering Information table.
0.09	04/15/09	Text edits.
0.10	05/19/09	Text edits.
0.11	09/04/09	Text edits.
0.12	09/18/09	Text edits.
0.13	10/29/09	Fixed typos on <a href="#">Table 4</a> .
0.14	08/20/12	Full D/S to be released.
F	03/21/2013	Changed layout of National Data Sheet to TI format

**PACKAGING INFORMATION**

Orderable Device	Status (1)	Package Type	Package Drawing	Pins	Package Qty	Eco Plan (2)	Lead finish/ Ball material (6)	MSL Peak Temp (3)	Op Temp (°C)	Device Marking (4/5)	Samples
LM49151TL/NOPB	ACTIVE	DSBGA	YZR	20	250	RoHS & Green	SNAGCU	Level-1-260C-UNLIM	-40 to 85	GL7	<b>Samples</b>
LM49151TLX/NOPB	ACTIVE	DSBGA	YZR	20	3000	RoHS & Green	SNAGCU	Level-1-260C-UNLIM	-40 to 85	GL7	<b>Samples</b>

(1) The marketing status values are defined as follows:

**ACTIVE:** Product device recommended for new designs.

**LIFEBUY:** TI has announced that the device will be discontinued, and a lifetime-buy period is in effect.

**NRND:** Not recommended for new designs. Device is in production to support existing customers, but TI does not recommend using this part in a new design.

**PREVIEW:** Device has been announced but is not in production. Samples may or may not be available.

**OBsolete:** TI has discontinued the production of the device.

(2) **RoHS:** TI defines "RoHS" to mean semiconductor products that are compliant with the current EU RoHS requirements for all 10 RoHS substances, including the requirement that RoHS substance do not exceed 0.1% by weight in homogeneous materials. Where designed to be soldered at high temperatures, "RoHS" products are suitable for use in specified lead-free processes. TI may reference these types of products as "Pb-Free".

**RoHS Exempt:** TI defines "RoHS Exempt" to mean products that contain lead but are compliant with EU RoHS pursuant to a specific EU RoHS exemption.

**Green:** TI defines "Green" to mean the content of Chlorine (Cl) and Bromine (Br) based flame retardants meet JS709B low halogen requirements of <=1000ppm threshold. Antimony trioxide based flame retardants must also meet the <=1000ppm threshold requirement.

(3) MSL, Peak Temp. - The Moisture Sensitivity Level rating according to the JEDEC industry standard classifications, and peak solder temperature.

(4) There may be additional marking, which relates to the logo, the lot trace code information, or the environmental category on the device.

(5) Multiple Device Markings will be inside parentheses. Only one Device Marking contained in parentheses and separated by a "~" will appear on a device. If a line is indented then it is a continuation of the previous line and the two combined represent the entire Device Marking for that device.

(6) Lead finish/Ball material - Orderable Devices may have multiple material finish options. Finish options are separated by a vertical ruled line. Lead finish/Ball material values may wrap to two lines if the finish value exceeds the maximum column width.

**Important Information and Disclaimer:**The information provided on this page represents TI's knowledge and belief as of the date that it is provided. TI bases its knowledge and belief on information provided by third parties, and makes no representation or warranty as to the accuracy of such information. Efforts are underway to better integrate information from third parties. TI has taken and continues to take reasonable steps to provide representative and accurate information but may not have conducted destructive testing or chemical analysis on incoming materials and chemicals. TI and TI suppliers consider certain information to be proprietary, and thus CAS numbers and other limited information may not be available for release.

In no event shall TI's liability arising out of such information exceed the total purchase price of the TI part(s) at issue in this document sold by TI to Customer on an annual basis.





**TAPE AND REEL INFORMATION**

**QUADRANT ASSIGNMENTS FOR PIN 1 ORIENTATION IN TAPE**

\*All dimensions are nominal

Device	Package Type	Package Drawing	Pins	SPQ	Reel Diameter (mm)	Reel Width W1 (mm)	A0 (mm)	B0 (mm)	K0 (mm)	P1 (mm)	W (mm)	Pin1 Quadrant
LM49151TL/NOPB	DSBGA	YZR	20	250	178.0	8.4	2.34	2.85	0.76	4.0	8.0	Q1
LM49151TLX/NOPB	DSBGA	YZR	20	3000	178.0	8.4	2.34	2.85	0.76	4.0	8.0	Q1

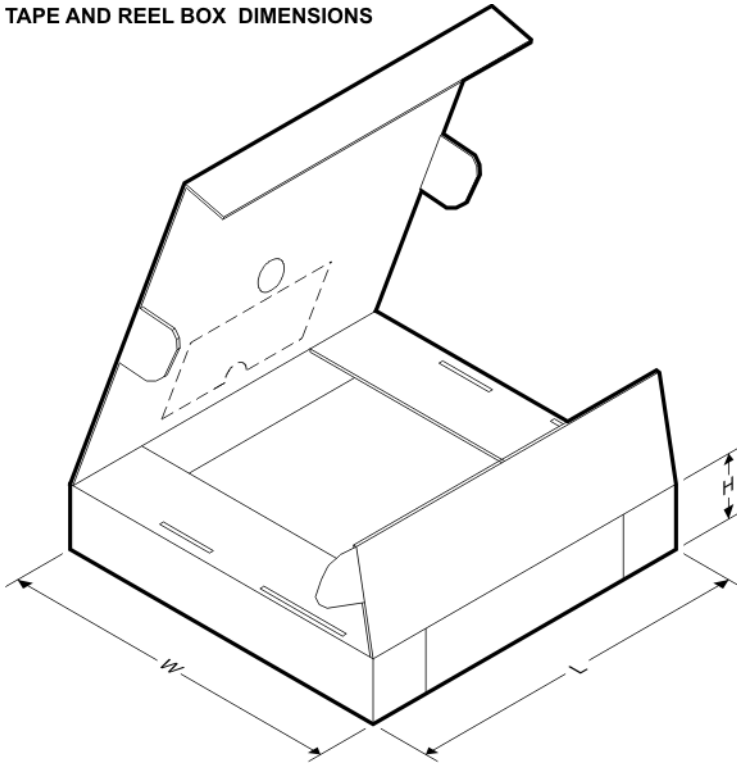
**TAPE AND REEL BOX DIMENSIONS**

\*All dimensions are nominal

Device	Package Type	Package Drawing	Pins	SPQ	Length (mm)	Width (mm)	Height (mm)
LM49151TL/NOPB	DSBGA	YZR	20	250	210.0	185.0	35.0
LM49151TLX/NOPB	DSBGA	YZR	20	3000	210.0	185.0	35.0

## IMPORTANT NOTICE AND DISCLAIMER

TI PROVIDES TECHNICAL AND RELIABILITY DATA (INCLUDING DATASHEETS), DESIGN RESOURCES (INCLUDING REFERENCE DESIGNS), APPLICATION OR OTHER DESIGN ADVICE, WEB TOOLS, SAFETY INFORMATION, AND OTHER RESOURCES "AS IS" AND WITH ALL FAULTS, AND DISCLAIMS ALL WARRANTIES, EXPRESS AND IMPLIED, INCLUDING WITHOUT LIMITATION ANY IMPLIED WARRANTIES OF MERCHANTABILITY, FITNESS FOR A PARTICULAR PURPOSE OR NON-INFRINGEMENT OF THIRD PARTY INTELLECTUAL PROPERTY RIGHTS.

These resources are intended for skilled developers designing with TI products. You are solely responsible for (1) selecting the appropriate TI products for your application, (2) designing, validating and testing your application, and (3) ensuring your application meets applicable standards, and any other safety, security, or other requirements. These resources are subject to change without notice. TI grants you permission to use these resources only for development of an application that uses the TI products described in the resource. Other reproduction and display of these resources is prohibited. No license is granted to any other TI intellectual property right or to any third party intellectual property right. TI disclaims responsibility for, and you will fully indemnify TI and its representatives against, any claims, damages, costs, losses, and liabilities arising out of your use of these resources.

TI's products are provided subject to TI's Terms of Sale ([www.ti.com/legal/termsofsale.html](http://www.ti.com/legal/termsofsale.html)) or other applicable terms available either on [ti.com](http://ti.com) or provided in conjunction with such TI products. TI's provision of these resources does not expand or otherwise alter TI's applicable warranties or warranty disclaimers for TI products.

Mailing Address: Texas Instruments, Post Office Box 655303, Dallas, Texas 75265  
Copyright © 2020, Texas Instruments Incorporated