

5

4

3

2

1

D

C

B

A

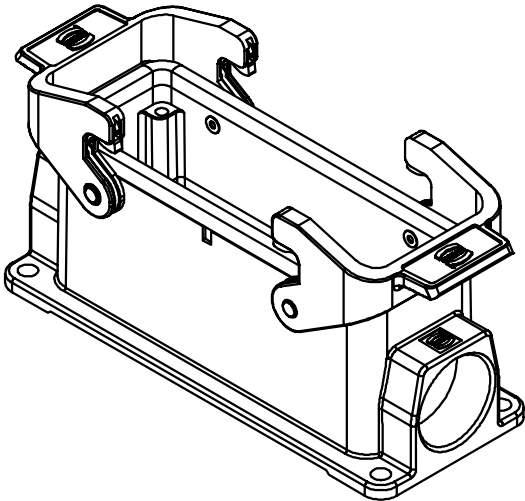
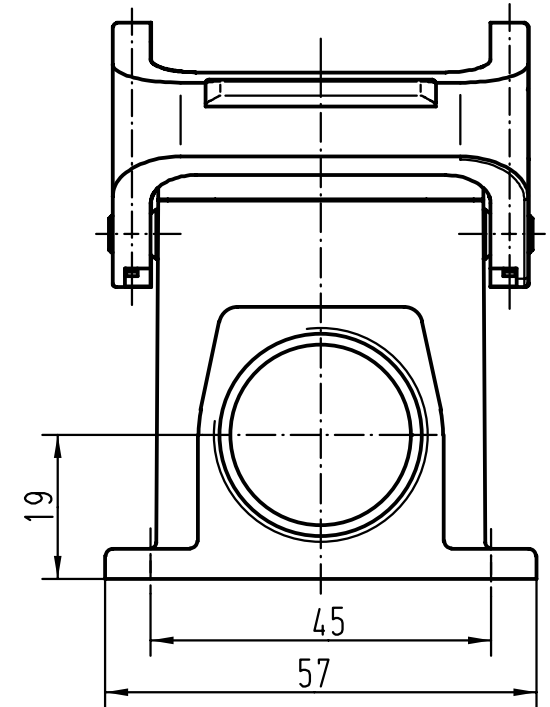
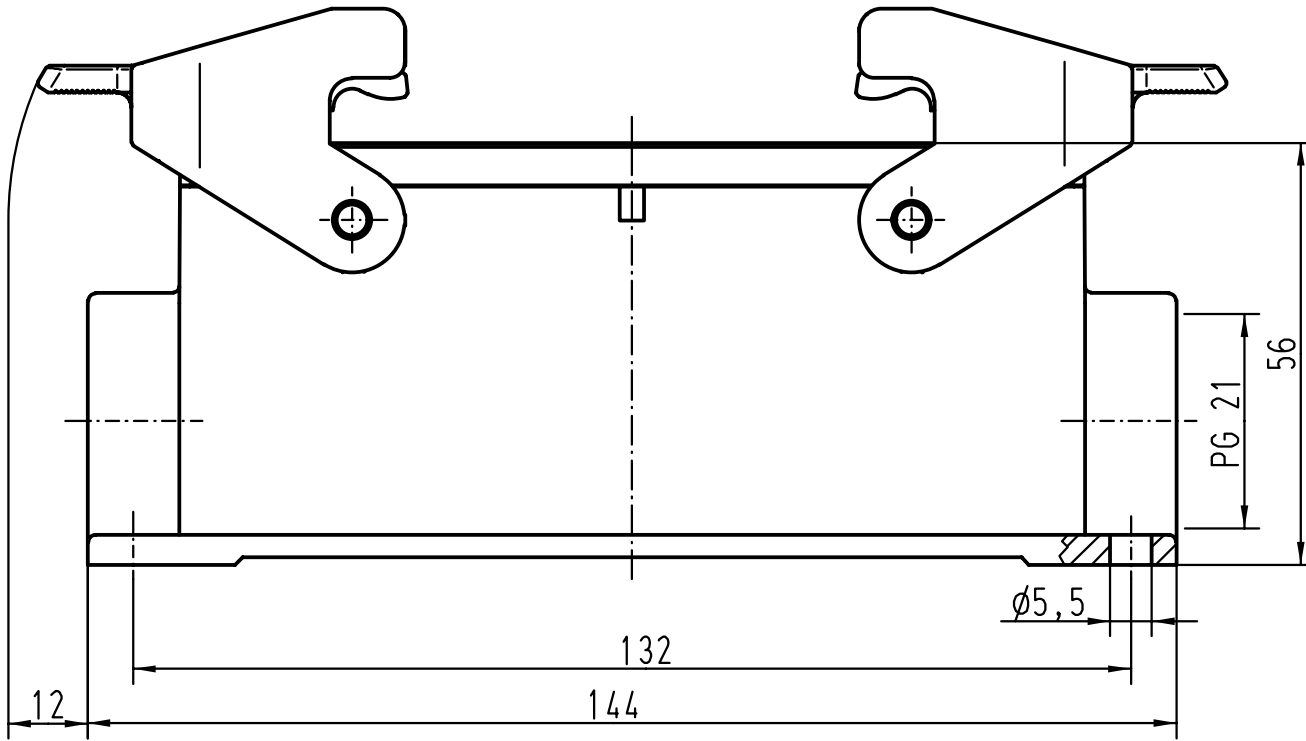

All Dimensions in mm Original Size DIN A 4		Techn. Character.			Nicht tolerierte Masse/ Free size tolerances	
			Dat.	Name	Massstab/ Scale 1:1	Han 24B-asg1-QB-21 Sockelgehäuse/ housings surface mounting
			Detail.	26.07.99 Gü		
			Insp.	Sdt		
			Stand.			
26138			HARTING KGaA			TB 09 30 024 1230 Sub. TB 09 30 0.. 123. v. 28.01.93
Mod.	Dat.	Name	D-32339 ESPELKAMP			
						Blatt/ page