



FEATURES:

- Suitable for RoHS reflow profile
- High current rating and low DCR
- Special lead wire design to prevent open circuit failure
- Excellent terminal strength to mechanical stress

APPLICATIONS:

- OA equipments
- PC and notebook
- LCD TV set
- Power supply

ELECTRICAL SPECIFICATIONS:

Abrakon P/N:	ASPI-0705 Series
Operating Temperature:	-40°C to +85°C
Storage Temperature:	+5°C to +40°C

PART NUMBER	INDUCTANCE (uH)	Tolerance	DCR (Ω) max	IDC (A) max	Inductance Code
ASPI-0705-100	10	K	0.07	2.30	100
ASPI-0705-120	12	K	0.08	2.00	120
ASPI-0705-150	15	K	0.09	1.80	150
ASPI-0705-180	18	K	0.10	1.60	180
ASPI-0705-220	22	K	0.11	1.50	220
ASPI-0705-270	27	K	0.12	1.30	270
ASPI-0705-330	33	K	0.13	1.20	330
ASPI-0705-390	39	K	0.16	1.10	390
ASPI-0705-470	47	K	0.18	1.10	470
ASPI-0705-560	56	K	0.24	0.94	560
ASPI-0705-680	68	K	0.28	0.85	680
ASPI-0705-820	82	K	0.37	0.78	820
ASPI-0705-101	100	K	0.43	0.72	101
ASPI-0705-121	120	K	0.47	0.66	121
ASPI-0705-151	150	K	0.64	0.58	151
ASPI-0705-181	180	K	0.71	0.51	181
ASPI-0705-221	220	K	0.96	0.49	221
ASPI-0705-271	270	K	1.11	0.42	271
ASPI-0705-331	330	K	1.26	0.40	331
ASPI-0705-391	390	K	1.77	0.36	391
ASPI-0705-471	470	K	1.96	0.34	471

Test Conditions

Inductance: 2.52MHz for 10μH ~ 82μH; 1kHz for 100μH ~ 470μH

Isat: ΔL/L (initial) ≥ -10% or ΔT=40°C (Ta=20°C), whichever is lower.

OPTIONS AND PART IDENTIFICATION

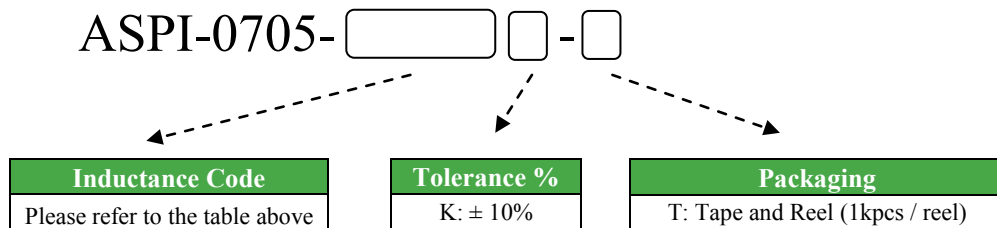



OUTLINE DRAWING:

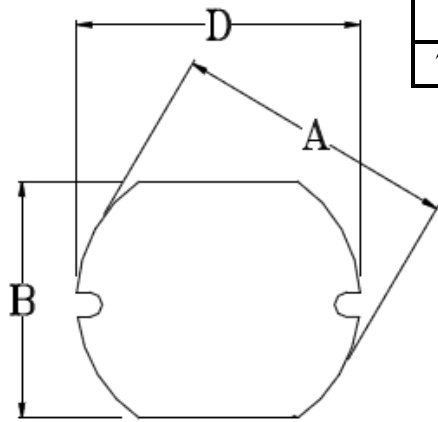

A	B	C	D	E	F	G
7.8±0.3	7.0±0.3	5.0±0.50	7.8±0.3	3.00	2.00	7.50

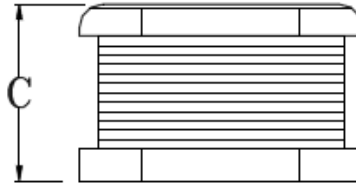

Recommended Land Pattern

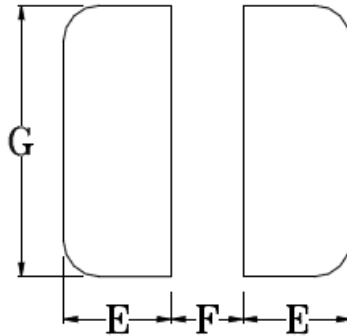
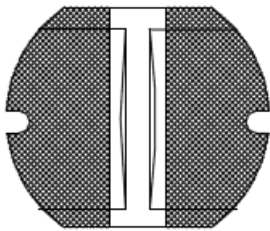

Dimension: mm

REFLOW PROFILE:

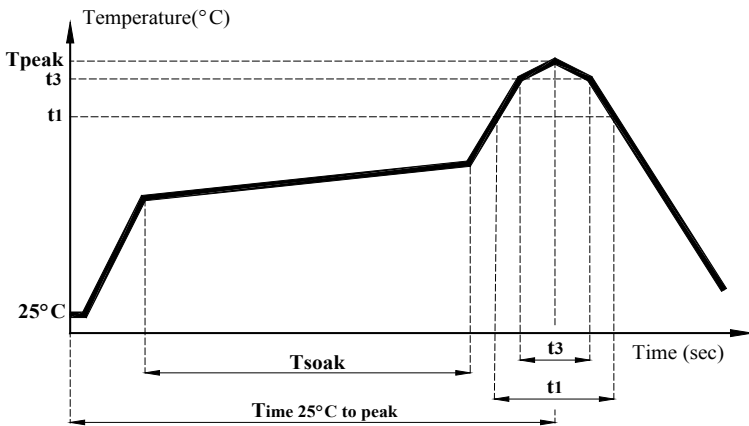

Item	mark	
Temperature rise gradient		3°C/sec (max)
Heating time	Tsoak	50s ~ 150s
Heating temperature		120°C~180°C
Time over 217°C	t1	70 sec
Time within 5°C of actual peak temperature	t3	10~30 sec
Peak temperature	Tpeak	250 (+0 / -5 °C)
Time 25°C to peak Temperature		6 minutes max.



TAPE & REEL:

T: 1,000pcs / reel

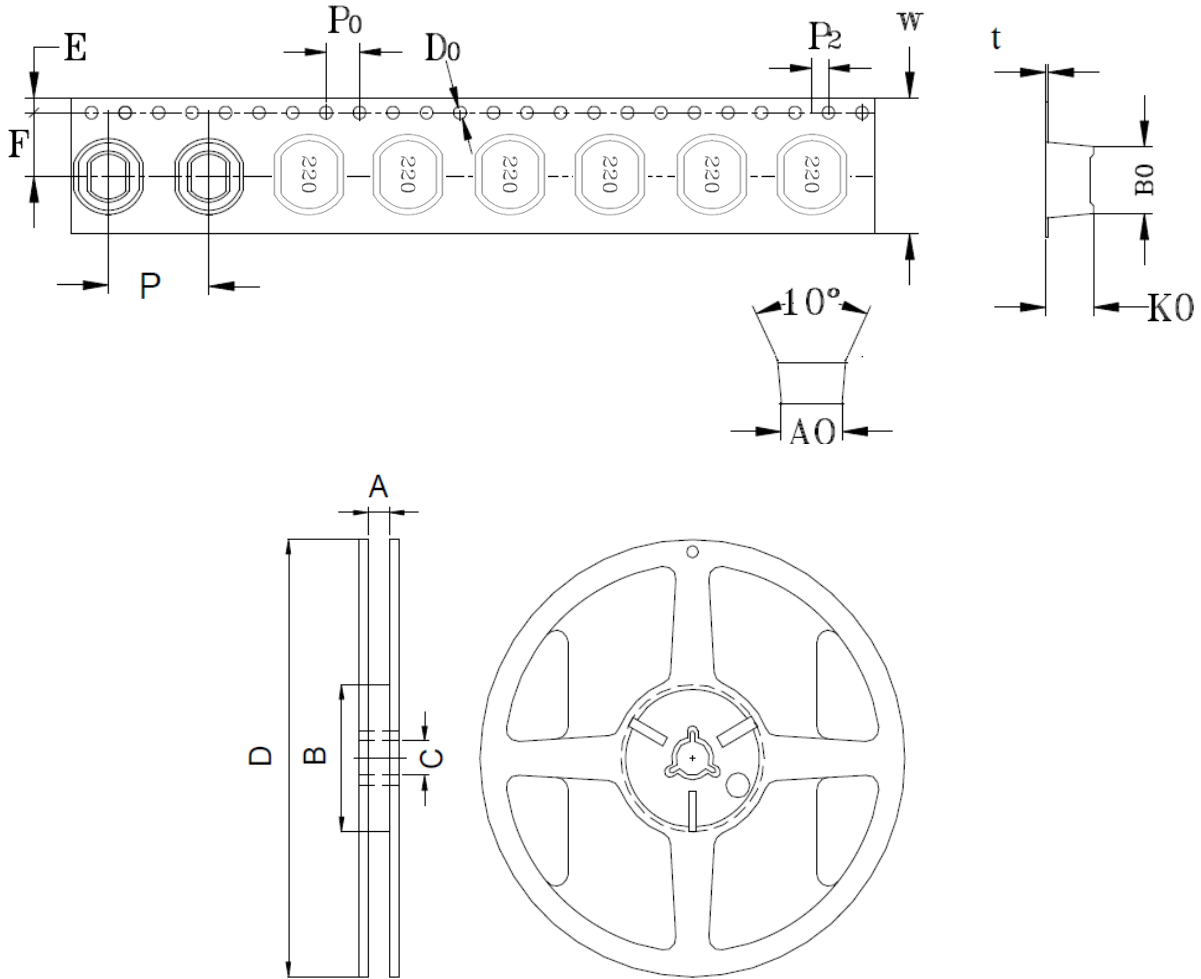

CARRIER TAPE / SIZE (mm)										REEL 13"×24mm			
A0	B0	K0	F	E	W	P	Po	P2	t	A	B	C	D
7.2 ± 0.1	8.1 ± 0.1	5.35 ± 0.1	7.5 ± 0.1	1.75 ± 0.1	16 ± 0.3	12 ± 0.1	4 ± 0.1	2 ± 0.1	0.4 ± 0.05	16.5 ± 0.2	100 ± 0.5	13.2 ± 0.3	330 ± 1.0

Dimension: mm

ATTENTION Abracon Corporation's products are COTS – Commercial-Off-The-Shelf products; suitable for Commercial, Industrial and, where designated, Automotive Applications. Abracon's products are not specifically designed for Military, Aviation, Aerospace, Life-dependant Medical applications or any application requiring high reliability where component failure could result in loss of life and/or property. For applications requiring high reliability and/or presenting an extreme operating environment, written consent and authorization from Abracon Corporation is required. Please contact Abracon Corporation for more information.

Mouser Electronics

Authorized Distributor

Click to View Pricing, Inventory, Delivery & Lifecycle Information:

ABRACON:

[ASPI-0705-100K-T](#) [ASPI-0705-271K-T](#) [ASPI-0705-270K-T](#) [ASPI-0705-390K-T](#) [ASPI-0705-680K-T](#) [ASPI-0705-101K-T](#) [ASPI-0705-121K-T](#) [ASPI-0705-471K-T](#) [ASPI-0705-391K-T](#) [ASPI-0705-151K-T](#) [ASPI-0705-181K-T](#) [ASPI-0705-331K-T](#) [ASPI-0705-220K-T](#) [ASPI-0705-470K-T](#) [ASPI-0705-820K-T](#) [ASPI-0705-150K-T](#) [ASPI-0705-180K-T](#) [ASPI-0705-330K-T](#) [ASPI-0705-560K-T](#) [ASPI-0705-221K-T](#) [ASPI-0705-120K-T](#)