



The plastic circular connector with metal locking

UTG provides the complete answer to the need for economical lightweight and robust metal coupling



Flammability rating ■ UL94-V0 compliant

Rapid and secure locking ■ Locks with audible positive «click»

Intermateable and interchangeable ■ With UTO, UTP and UTS series

Complete range of contacts ■ Trim Trio contacts #16

Layout

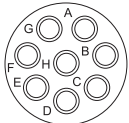
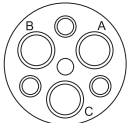
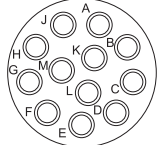
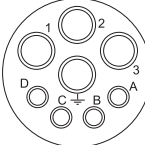
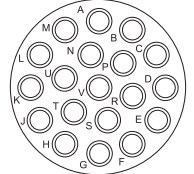
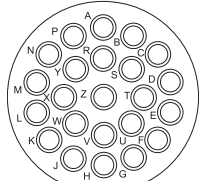
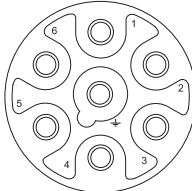
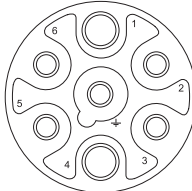
| Shell size | Contact # 16 (Ø 1,6) | Mixed power / signal versions | |
|------------|---|---|--|
| 10 |  <p>10-4 4 x #16 (Ø 1,6)</p> |  <p>10-3 3 x #16 (Ø 1,6) Group C 250V</p> |  <p>10-3W3 3 x #16 (Ø 1,6) 3 x #20 (Ø 1,0)</p> |
| 12 |  <p>12-8 8 x #16 (Ø 1,6)</p> |  <p>122G1 3 x #12 (Ø 2,4)</p> | |
| 14 |  <p>14-12 12 x #16 (Ø 1,6)</p> |  <p>14-8 4 x #12 (Ø 2,4) 4 x #16 (Ø 1,6)</p> | |
| 16 |  <p>16-19 19 x #16 (Ø 1,6)</p> | | |
| 18 |  <p>18-23 23 x #16 (Ø 1,6)</p> |  <p>18-7 Group C 380V 7 x #16 (Ø 1,6)</p> |  <p>18-7 34 2 x #12 (Ø 2,4) 5 x #16 (Ø 1,6)</p> |

UTG Series

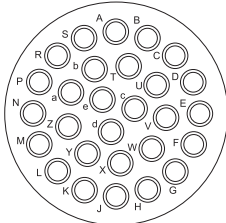
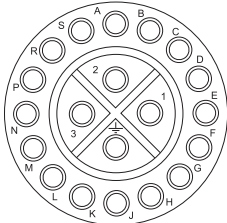
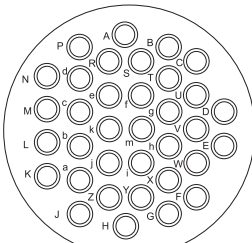
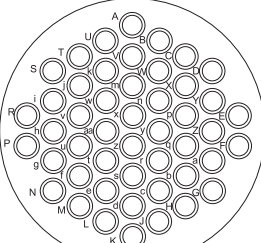
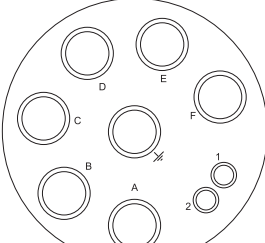
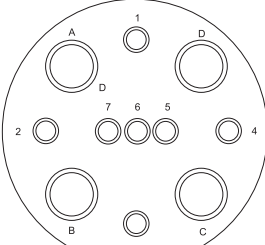
| Shell size | Contact # 16 (Ø 1,6) | Mixed power / signal versions |
|------------|---|---|
| 20 |  <p data-bbox="537 663 716 722">20-28 28 x #16 (Ø 1,6)</p> |  <p data-bbox="1138 663 1317 751">20-20 20 x #16 (Ø 1,6) Group C 660V</p> |
| 22 |  <p data-bbox="537 1062 716 1121">22-35 35 x #16 (Ø 1,6)</p> | |
| 24 |  <p data-bbox="537 1451 716 1509">24-48 48 x #16 (Ø 1,6)</p> |  <p data-bbox="1138 1451 1317 1539">24-7 7 x #8 (Ø 3,6) 2 x #16 (Ø 1,6)</p> |
| | |  <p data-bbox="1138 1839 1317 1927">24-11 4 x #8 (Ø 3,6) 7 x #16 (Ø 1,6)</p> |

Contact identification positions shown are for mating face of pin contact connectors and wire face of socket contact connectors.



Specifications

| Shell size | Contacts number* | Connector type / Part number | | | |
|------------|------------------|------------------------------|---------------|---------------------------|---------------|
| | | Cable plug | | Panel mounting receptacle | |
| | | Male insert | Female insert | Male insert | Female insert |
| 10 | 4 #16 | UTG6104PN | UTG6104SN | UTG0104P | UTG0104S |
| | 2 + ground #16 | UTG6103PN | UTG6103SN | UTG0103P | UTG0103S |
| | 3 #20 + 3 #16 | UTG6103W3PN | - | - | - |
| 12 | 8 #16 | UTG6128PN | UTG6128SN | UTG0128P | UTG0128S |
| | 3 #12 | UTG6122G1PN | UTG6122G1SN | UTG0122G1P | UTG0122G1S |
| 14 | 12 #16 | UTG61412PN | UTG61412SN | UTG01412P | UTG01412S |
| | 4#12 + 4 #16 | - | UTG6148SN | UTG0148P | - |
| 16 | 19 #16 | UTG61619PN | UTG61619SN | UTG01619P | UTG01619S |
| 18 | 23 #16 | UTG61823PN | UTG61823SN | UTG01823P | UTG01823S |
| | 7 #16 | UTG6187PN | UTG6187SN | UTG0187P | UTG0187S |
| | 2 #12 + 5 #16 | UTG6187PN34 | UTG6187SN34 | UTG0187P34 | UTG0187S34 |
| 20 | 28 #16 | UTG62028PN | UTG62028SN | UTG02028P | UTG02028S |
| | 20 #16 | UTG62020PN | UTG62020SN | UTG02020P | UTG02020S |
| 22 | 35 #16 | UTG62235PN | UTG62235SN | UTG02235P | UTG02235S |
| 24 | 48 #16 | UTG62448PN | UTG62448SN | UTG02448P | UTG02448S |
| | 7 #8 + 2 #16 | UTG6247PN | UTG6247SN | UTG0247P | UTG0247S |
| | 4 #8 + 7 #16 | - | UTG62411SN | UTG02411P | - |

*Contacts supply separately

For IP65 waterprotected version (for only receptacle) add «H» behind N or S. Ex. UTG0103PH

Dimensions

Cable Plug - UTG6

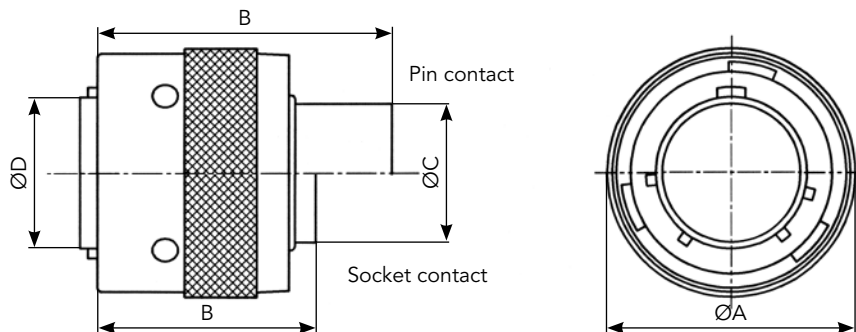

| Shell size | ØA ^{±0.2} | B max | | ØC ^{±0.15} | ØD ^{±0.15} | ØE ^{±0.2} |
|------------|--------------------|-------------|----------------|---------------------|---------------------|--------------------|
| | | Pin contact | Socket contact | | | |
| 10 | 21.6 | 31.8 | 23.9 / 26.75 | 10.9 | 12.2 | 19.1 |
| 12 | 24.8 | | 23.9 | 13.8 | 15.1 | |
| 14 | 28.0 | | | 17.0 | 18.3 | |
| 16 | 31.2 | | 19.9 | 21.5 | | |
| 18 | 34.3 | 31.8 / 33.0 | 23.9 / 29.0 | 22.4 | 24.0 | |
| 20 | 37.5 | 31.8 / 35.3 | 24.9 | 25.6 | 27.2 | |
| 22 | 47.0 | 31.8 | | 28.5 | 30.4 | |
| 24 | 50.1 | | 26.2 | 31.7 | 33.5 | |

Wall Mounting - UTG0

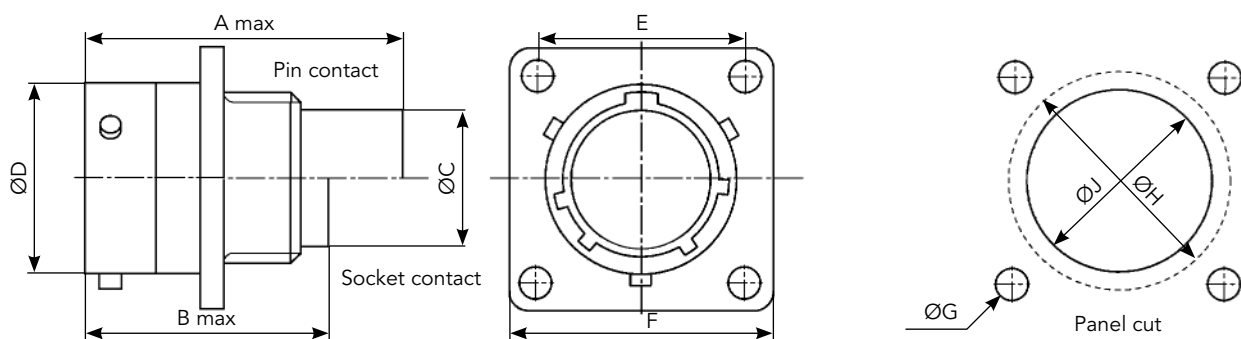

| Shell size | A max | | B ^{±0.15} | C ^{±0.2} | ØD ^{±0.15} | ØE ^{±0.2} | F ^{±0.25} | ØG ^{±0.1} | ØH ^{±0.1} | ØJ ^{±0.1} |
|------------|-------------|----------------|--------------------|-------------------|---------------------|--------------------|--------------------|--------------------|--------------------|--------------------|
| | Pin contact | Socket contact | | | | | | | | |
| 10 | 31.7 | 24.3 / 27.6 | 2.3 | 11.3 | 15.0 | 18.3 | 23.8 | 3.2 | 17.3 | 15.1 |
| 12 | | 24.3 | | | 19.0 | 20.6 | 26.2 | | 21.8 | 18.2 |
| 14 | | | | | 22.2 | 23.0 | 28.6 | | 25.0 | 21.4 |
| 16 | | 25.3 | | | 24.6 | 31.0 | 28.1 | | 24.6 | |
| 18 | 31.7 / 34.0 | 24.3 / 30.4 | 2.5 | 11.3 / 17.9 | 28.5 | 27.0 | 33.3 | | 31.3 | 27.7 |
| 20 | 33.3 | 27.0 | | 14.5 | 31.7 | 29.4 | 36.5 | | 34.5 | 30.9 |
| 22 | | 28.0 | 34.9 | | 31.8 | 39.7 | 37.7 | | 34.1 | |
| 24 | | 30.4 | 3.5 | 15.3 | 38.0 | 34.9 | 42.9 | | 3.9 | 40.9 |

Note: all dimensions are in mm



Specifications

| Shell size | Contacts number* | Connector type / Part number | |
|------------|------------------|------------------------------|-------------------|
| | | Free hanging receptacle | |
| | | Male insert | Female insert |
| 10 | 4 #16 | UTG1104P | UTG1104S |
| | 2 + ground #16 | UTG1103P | UTG1103S |
| | 3 #20 + 3 #16 | - | UTG1103W3S |
| 12 | 8 #16 | UTG1128P | UTG1128S |
| 14 | 12 #16 | UTG11412P | UTG11412S |
| 16 | 19 #16 | UTG11619P | UTG11619S |
| 18 | 23 #16 | UTG11823P | UTG11823S |
| 20 | 28 #16 | UTG12028P | UTG12028S |
| 22 | 35 #16 | UTG12235P | UTG12235S |
| 24 | 48 #16 | UTG12448P | UTG12448S |
| | 7 #8 + 2 #16 | UTG1247P | UTG1247S |

*Contacts supply separately
 For IP65 waterprotected version (for only receptacle) add «H» behind N or S. Ex. UTG1103PH

Dimensions

Free Hanging - UTG1

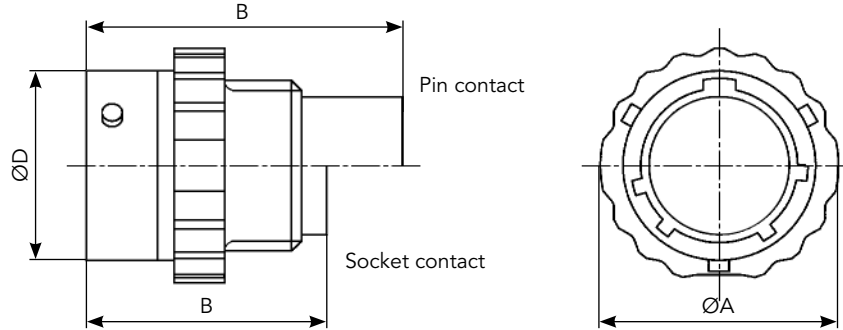

| Shell size | $\text{ØA}^{\pm 0.2}$ | B max | | $\text{ØD}^{\pm 0.15}$ |
|------------|-----------------------|-------------|----------------|------------------------|
| | | Pin contact | Socket contact | |
| 10 | 19.5 | 31.7 | 24.3 / 27.6 | 15.0 |
| 12 | 23.5 | | 24.3 | 19.0 |
| 14 | 27 | | | 22.2 |
| 16 | 30.0 | | 25.3 | |
| 18 | 33.3 | 31.7 / 34.0 | 24.3 / 30.4 | 28.5 |
| 20 | 36.5 | 33.3 / 34.3 | 25.9 | 31.7 |
| 22 | 39.5 | 38.0 | | 34.9 |
| 24 | 42.1 | | | 38.0 |

Accessories

Cable Clamp



| Part number | Shell size |
|-------------|------------|
| UTG10AC | 10 |
| UTG12AC | 12 |
| UTG14AC | 14 |
| UTG16AC | 16 |
| UTG18AC | 18 |
| UTG20AC | 20 |
| UTG22AC | 22 |
| UTG24AC | 24 |

Cable Clamp for Waterprotected (IP65) Applications



| Part number | Shell size |
|-------------|------------|
| UTG10PG | 10 |
| UTG12PG | 12 |
| UTG14PG | 14 |
| UTG16PG | 16 |
| UTG18PG | 18 |
| UTG20PG | 20 |
| UTG22PG | 22 |
| UTG24PG | 24 |

Cable Gland for Waterprotected (IP65) Applications



| Part number | Shell size |
|-------------|------------|
| UTG10ST | 10 |
| UTG12ST | 12 |
| UTG14ST | 14 |
| UTG16ST | 16 |
| UTG18ST | 18 |
| UTG20ST | 20 |
| UTG22ST | 22 |
| UTG24ST | 24 |

Metal Shrink Boot



| Part number | Shell size |
|-------------|------------|
| UTG10AD | 10 |
| UTG12AD | 12 |
| UTG14AD | 14 |
| UTG16AD | 16 |
| UTG18AD | 18 |
| UTG20AD | 20 |
| UTG22AD | 22 |
| UTG24AD | 24 |

Dustcap (Receptacle)



| Part number | Shell size |
|-------------|------------|
| UTP10DC | 10 |
| UTP12DC | 12 |
| UTP14DC | 14 |
| UTP16DC | 16 |
| UTP18DC | 18 |
| UTP20DC | 20 |
| UTP22DC | 22 |
| UTP24DC | 24 |

Dustcap with Chain (Receptacle)



| Part number | Shell size |
|-------------|------------|
| UTP10DCG | 10 |
| UTP12DCG | 12 |
| UTP14DCG | 14 |
| UTP16DCG | 16 |
| UTP18DCG | 18 |
| UTP20DCG | 20 |
| UTP22DCG | 22 |
| UTP24DCG | 24 |

Plastic Protective Cap for Receptacle



| Part number | Shell size |
|-------------|------------|
| 8500-5586A | 10 |
| 8500-5587A | 12 |
| 8500-5588A | 14 |
| 8500-5589A | 16 |
| 8500-5590A | 18 |
| 8500-5591A | 20 |
| 8500-5592A | 22 |
| 8500-5593A | 24 |

Gasket



| Part number | Shell size |
|-------------|------------|
| UTFD12B | 10 |
| UTFD13B | 12 |
| UTFD14B | 14 |
| UTFD15B | 16 |
| UTFD16B | 18 |
| UTFD17B | 20 |
| UTFD18B | 22 |
| UTFD19B | 24 |

Contact Selector Guide

Contact supplied separately

| Electrical characteristics: contact resistance | | |
|--|------------------|-------|
| #20 Ø1mm | Machined | < 6mΩ |
| | Stamped & Formed | < 6mΩ |
| #16 Ø1.6mm | Machined | < 3mΩ |
| | Stamped & Formed | < 6mΩ |
| #12 Ø2.4mm | Machined | < 5mΩ |
| #8 Ø3.6mm | Machined | < 5mΩ |

| Available platings (contact supplied separately) | |
|---|---|
| A | 2μ Ni + 2μ Ag |
| J | Gold flash over 2μ Ni |
| K | Min 0.4μ gold over 2μ Ni |
| S31 | Active part: Gold flash over Ni Crimp area: Nickel |
| S18 | Active part: 0.75μ gold min over 2μ Ni Crimp area: 1.3μ tin over Ni Other: Nickel |
| S25 S26 | Active part: 0.75μ Au over Ni Crimp area: flash Au over Ni |
| TK6 | 2-5μ Sn pre-plated |
| D70 | Superseded by S31 |
| S6 | Superseded by S18 |
| Other platings on request (contact supplied separately) | |
| T | T: 2μ Ni mini all over + 3 to 5 μm Sn all over |
| D28 | 0.75μ gold over Ni |

Packaging

Due to the wide variety of applications, contact packaging is offered for small series (bulk package) and high volume production (reeled contacts):

Size contacts #20 (Ø1mm) & #16 (Ø1.6mm)



- 25 pieces loose package (Stamped & Formed contacts)



- 50 pieces bulk package (Machined contacts)



- 1,000 pieces bulk package (Machined contacts)

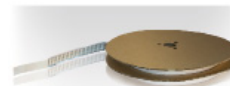

- 3,000 pieces reeled (Stamped & Formed contacts)

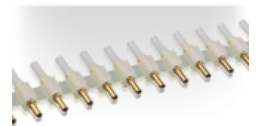

- 2,000 pieces reeled (Machined contacts)
Size #16 only

Size contacts #12 (Ø2.4mm) & #8 (Ø3.6mm)



- 100 pieces bulk package (Machined contacts)

Note: 1,000 pieces bulk package available by adding 1000 at the end of the part number: e.g. RC16M23K1000
2,000 pieces reeled package available by adding K at the beginning of the part number: e.g. KRC16M23K

Crimp Contacts

Standard Version



| Contact size | Type | Wire size | | Part number | | Max wire Ø | Max insulator Ø | Available plating | |
|------------------|------------------|------------|-----------------|----------------|---------------|--------------------|-----------------------------------|-----------------------------------|---|
| | | AWG | mm ² | Male | Female | | | | |
| #20 Ø1 mm | Machined | 26-24 | 0.13-0.20 | RM24W3K | RC24W3K | - | 1.58 max | K | |
| | Stamped & Formed | 26-24 | 0.13-0.25 | SM24W3 - (1) | SC24W3 - (1) | - | 0.89-1.58 | TK6 S25 (female) S26 (male) | |
| | | | | SM24WL3 - (2) | SC24WL3 - (2) | - | | | |
| | Machined | 22-20 | 0.32-0.52 | 0.35-0.5 | RM20W3K | RC20W3K | - | 1.58 max | K |
| | | | | | SM20W3 - (1) | SC20W3 - (1) | - | | |
| Stamped & Formed | 22-20 | 0.35-0.5 | SM20WL3 - (2) | SC20WL3 - (2) | - | 1.17-2.08 | TK6 S25 (female) S26 (male) | | |
| Machined | 20-18 | 0.50-0.93 | | RM18W3K | RC18W3K | | 2.10 max | K | |
| #16 Ø1.6 mm | Machined | 30-28 | 0.05-0.08 | RM28M1- | RC28M1- | 0.55 | 1.1 | K, J | |
| | Machined | 26-24 | 0.13-0.2 | RM24M9- | RC24M9- | 0.8 | 1.6 | K, J | |
| | Stamped & Formed | 26-24 | 0.13-0.25 | SM24M1 - (1) | SC24M1 - (1) | 0.89-1.28 | Insulation grip | S31, S18, TK6 | |
| | | | | SM24ML1 - (2) | SC24ML1 - (2) | | | | |
| | Machined | 22-20 | 0.32-0.52 | RM20M13- | RC20M13- | 1.18 | 1.8 | K, J | |
| | | | | RM20M12- | RC20M12- | | | | |
| | Stamped & Formed | 22-20 | 0.35-0.5 | SM20M1 - (1) | SC20M1 - (1) | 1.17-2.08 | Insulation grip | S31, S18, TK6 | |
| | | | | SM20ML1 - (2) | SC20ML1 - (2) | | | | |
| | Machined | 20-16 | 0.52-1.5 | RM16M23- | RC16M23- | 1.8 | 3.2 | K, J | |
| | Stamped & Formed | 18-16 | 0.8-1.5 | SM16M1 - (1) | SC16M1 - (1) | 3.0 | No insulation grip | S31, S18, TK6 | |
| SM16ML1 - (2) | | | | SC16ML1 - (2) | | | | | |
| Stamped & Formed | 18-16 | 0.8-1.5 | SM16M11 - (1) | SC16M11 - (1) | 2.0-3.0 | Insulation grip | S31, S18, TK6 | | |
| | | | SM16ML11 - (2) | SC16ML11 - (2) | | | | | |
| Machined | 16-14 | 1.5-2.5 | RM14M30- | RC14M30- | 2.28 | 3.2 | K, J | | |
| Stamped & Formed | 14 | 2.0-2.5 | SM14M1 - (1) | SC14M1 - (1) | 3.2 | No insulation grip | S31, S18, TK6 | | |
| | | | SM14ML1 - (2) | SC14ML1 - (2) | | | | | |
| #12 Ø2.4 mm | Machined | 22 | 0.13-0.4 | 82911457N- | 82911456- | - | 4.9 | A, K | |
| | | 20 | 0.5 | 82911459N- | 82911458- | | | | |
| | | 18 | 0.75-1.0 | 82911461N- | 82911460- | | | | |
| | | 16 | 1.5 | 82911463N- | 82911462- | | | | |
| | | 14 | 2.5 | 82911465N- | 82911464- | | | | |
| 12 | 4 | 82911467N- | 82911466- | | | | | | |
| #8 Ø3.6 mm | Machined | 16 | 1.5 | 82913601A | 82913600A | - | 6.5 | A | |
| | | 14 | 2.5 | 82913603A | 82913602A | | | | |
| | | 12 | 4 | 82913605A | 82913604A | | | | |
| | | 10 | 6.0 | 82913607A | 82913606A | | | | |
| | | 8 | 10.0 | 82913609A | 82913608A | | | | |

(1) contact reeled (2) loose contact
 Example: RM24W3K - Size #20, Machined, AWG24 wire.

Note: all dimensions are in mm

Crimp Contacts (Continued)

First Mate Last Break Contacts

| Contact size | Type | Wire size | | Part number | | Max wire Ø (mm) | Max insulator Ø (mm) | Color band | | Available plating |
|---|----------|-----------|-----------------|-------------|-------------|-----------------|----------------------|------------|------|-------------------|
| | | AWG | mm ² | Male | Female | | | Front | Rear | |
| #16 Ø1.6 mm Longer male contact (+1mm) | Machined | 30-28 | 0.05-0.08 | RM28M1GE1- | - | 0.55 | 1.1 | - | Red | K, J |
| | | 26-24 | 0.13-0.2 | RM24M9GE1- | | 0.8 | 1.6 | Red | Red | |
| | | 22-20 | 0.32-0.52 | RM20M13GE1- | | 1.18 | 1.8 | Black | Red | |
| | | | | RM20M12GE1- | | | 2.2 | Blue | Red | |
| | | 20-16 | 0.52-1.5 | RM16M23GE1- | | 1.8 | 3.2 | - | Red | |
| | | 16-14 | 1.5-2.5 | RM14M30GE1- | | 2.28 | - | - | Red | |
| #16 Ø1.6 mm Shorter female contact (-0.7mm) | Machined | 30-28 | 0.05-0.08 | - | RC28M1GE7- | 0.55 | 1.1 | - | Blue | K, J |
| | | 26-24 | 0.13-0.2 | | RC24M9GE7- | 0.8 | 1.6 | Red | Blue | |
| | | 22-20 | 0.32-0.52 | | RC20M13GE7- | 1.18 | 1.8 | Black | Blue | |
| | | | | | RC20M12GE7- | | 2.2 | Blue | Blue | |
| | | 20-16 | 0.52-1.5 | | RC16M23GE7- | 1.8 | 3.2 | - | Blue | |
| | | 16-14 | 1.5-2.5 | | RC14M30GE7- | 2.28 | - | - | Blue | |

How to make FMLB / LMFB connection

| Contact 1 \ Contact 2 | Standard male contact | Standard female contact | Longer male contact |
|-------------------------|-----------------------|-------------------------|---------------------|
| Standard male contact | | ✓ | |
| Standard female contact | ✓ | | ✓ FMLB |
| Shorter female contact | ✓ LMFB | | |

First Mate Last Break contacts should be chosen only if the cavity is not marked with the ground symbol. For cavities marked with the ground symbol, standard contacts will fulfill the same role as a first mate, last break contact used in a standard cavity.



Ground symbol

Tooling

Crimp Tool Table

Standard contacts

| Contact size | Part number | Head* | Handles* | Extraction tools |
|------------------|---------------|-----------|----------|------------------|
| #20 Ø1 mm | RM/RC 24W3K | S20RCM | SHANDLES | RX20D44 |
| | RM/RC 20W3K | | | |
| | RM/RC 18W3K | | | |
| | SM 24WL3S*(1) | S20SCM20 | | |
| | SC 24WL3S*(1) | | | |
| SM/SC 20WL3S*(1) | S16RCM20 | RX2025GE1 | | |
| RM/RC 28M1* | | | | |
| RM/RC 24M9* | | | | |
| RM/RC 20M13* | | | | |
| RM/RC 20M12* | | | | |
| RM/RC 16M23* | | S16RCM16 | | |
| RM/RC 14M30* | | S16RCM14 | | |
| SM/SC 24ML1*(1) | | S16SCM20 | | |
| SM/SC 20ML1*(1) | | S16SCML1 | | |
| SM/SC 16ML1*(1) | | | | |
| SM/SC 14ML1*(1) | | | | |
| SM/SC 16ML11*(1) | S16SCML11 | | | |

(1) loose contact * endurance of SHANDLES & Head tools = 50,000 cycles

| Contact size | Part number | Tool with separate locator | | | Extraction tools |
|----------------|------------------------|----------------------------|------------------------------|-----|------------------|
| | | Hand tool | Positioner + locator setting | | |
| #12 Ø2.4 mm | 82911457N* / 82911456* | M317 | VGE10077A | 1-2 | 51060210924 |
| | 82911459N* / 82911458* | | | 2 | |
| | 82911461N* / 82911460* | | | 2 | |
| | 82911463N* / 82911462* | | | 3 | |
| | 82911465N* / 82911464* | | | 3 | |
| | 82911467N* / 82911466* | | | 4 | |
| #8 Ø3.6 mm | 82913601A / 82913600A | M317 | VGE10078A | 3 | 51060210936 |
| | 82913603A / 82913602A | | | 3 | |
| | 82913605A / 82913604A | | | 4 | |
| | 82913607A / 82913606A | | | 5 | |
| | 82913609A / 82913608A | | | 6/7 | |

* see page 169 for plating options and other contact details

Specific contacts (First mate Last break contacts)

| Contact size | Part number* | Hand tools (SHANDLES) head | Tool with separate locator | | | Extraction tools | | | |
|---------------------------------------|--------------|-------------------------------|----------------------------|------------------------------|------|------------------|-------|---------|-----|
| | | | Hand tool | Positioner + locator setting | | | | | |
| #16 Ø1 mm Longer RM contact | RM28M1GE1K | S16RCM20 | - | - | - | RX2025GE1 | | | |
| | RM24M9GE1K | | | | | | | | |
| | RM20M13GE1K | | | | | | | | |
| | RM16M23GE1K | S16RCM16 | | | | | MH860 | MH86186 | 6/8 |
| | RM20M12GE1K | S16RCM14 | | | | | - | - | - |
| RM14M30GE1K | | | | | | | | | |
| #16 Ø1 mm Shorter RC contact | RC28M1GE7K | S16RCM20 | MH860 | MH86164G | 4/6 | | | | |
| | RC24M9GE7K | | | | 5/6 | | | | |
| | RC20M13GE7K | | | | 5/7 | | | | |
| | RC20M12GE7K | S16RCM16 | | | 6/8 | | | | |
| | RC16M23GE7K | | | | | | | | |
| | RC14M30GE7K | S16RCM14 | | | M317 | UH25 | 3 | | |

* example of plating, for other plating consult us.

Coaxial contacts

Consult us

SOURIAU
souriau-industrial.com
contactindustry@souriau.com



Mouser Electronics

Authorized Distributor

Click to View Pricing, Inventory, Delivery & Lifecycle Information:

[Souriau:](#)

[UTG20AD](#)