

MAX1935

500mA, Low-Voltage Linear Regulator in Tiny DFN

General Description

The MAX1935 low-dropout linear regulator operates from a 2.25V to 5.5V supply and delivers a guaranteed 500mA load current with low 175mV dropout. The high-accuracy ($\pm 1.5\%$) output voltage is preset at an internally trimmed voltage or can be adjusted from 0.8V to 4.5V with an external resistive-divider.

An internal PMOS pass transistor allows low 210 μ A supply current, making this device ideal for portable equipment such as personal digital assistants (PDAs), cellular phones, cordless phones, and other equipment, including base stations and docking stations.

Other features include an active-low, power-OK output that indicates when the output is out of regulation, a 0.02 μ A shutdown mode, short-circuit protection, and thermal-shutdown protection. The MAX1935 comes in a tiny 1.9W, 8-pin 3mm x 3mm thin DFN package.

Applications

- Notebook Computers
- Cellular and Cordless Telephones
- PDAs
- Palmtop Computers
- Base Stations
- USB Hubs
- Docking Stations

Features

- Guaranteed 500mA Output Current
- Output Down to 0.8V
- Low 175mV Dropout at 500mA
- $\pm 1.5\%$ Output Voltage Accuracy
 - Preset at 1.5V
 - Adjustable from 0.8V to 4.5V
- Power-OK Output
- Low 210 μ A Ground Current
- 0.02 μ A Shutdown Current
- Thermal-Overload Protection
- Output Current Limit
- Tiny 1.9W, 8-Pin 3mm x 3mm Thin DFN Package

Ordering Information

PART	TEMP RANGE	PIN-PACKAGE
MAX1935ETA*	-40°C to +85°C	8 Thin DFN 3mm x 3mm
MAX1935ETA15*	-40°C to +85°C	8 Thin DFN 3mm x 3mm

*Contact factory for preset output voltages.

Selector Guide

PART	OUTPUT VOLTAGE	TOP MARK
MAX1935ETA	Adjustable	ADB
MAX1935ETA15	1.5V	ADB

Typical Operating Circuit

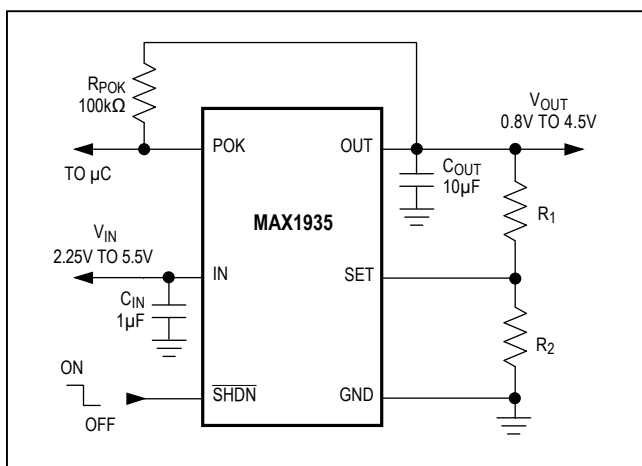

Pin Configuration

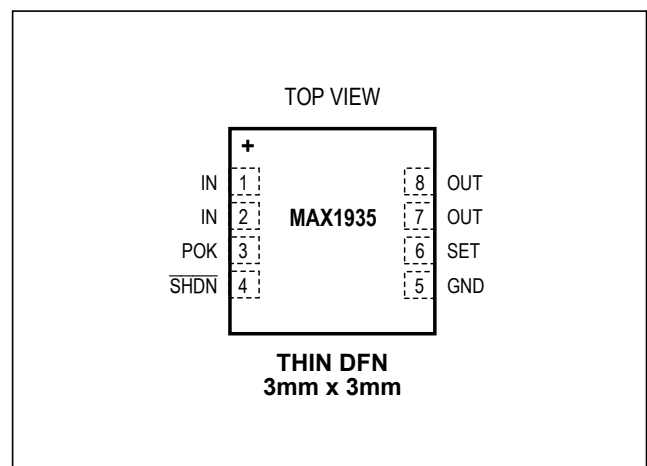

Absolute Maximum Ratings

IN, $\overline{\text{SHDN}}$, POK, SET to GND -0.3V to +6V
 OUT to GND -0.3V to ($V_{\text{IN}} + 0.3\text{V}$)
 Output Short-Circuit Duration Continuous
 Continuous Power Dissipation ($T_{\text{A}} = +70^{\circ}\text{C}$)
 8-Pin Thin DFN (derate 24.4mW/ $^{\circ}\text{C}$ above $+70^{\circ}\text{C}$) 1.95W

Operating Temperature -40°C to $+85^{\circ}\text{C}$
 Junction Temperature $+150^{\circ}\text{C}$
 Storage Temperature Range -65°C to $+150^{\circ}\text{C}$
 Lead Temperature (soldering, 10s) $+300^{\circ}\text{C}$

Stresses beyond those listed under "Absolute Maximum Ratings" may cause permanent damage to the device. These are stress ratings only, and functional operation of the device at these or any other conditions beyond those indicated in the operational sections of the specifications is not implied. Exposure to absolute maximum rating conditions for extended periods may affect device reliability.

Package Information

TDFN

PACKAGE CODE	T833+2C
Outline Number	21-0137
Land Pattern Number	90-0059
Thermal Resistance, Four-Layer Board:	
Junction to Ambient (θ_{JA})	41 $^{\circ}\text{C}/\text{W}$
Junction to Case (θ_{JC})	8 $^{\circ}\text{C}/\text{W}$

For the latest package outline information and land patterns (footprints), go to www.maximintegrated.com/packages. Note that a "+", "#", or "-" in the package code indicates RoHS status only. Package drawings may show a different suffix character, but the drawing pertains to the package regardless of RoHS status.

Package thermal resistances were obtained using the method described in JEDEC specification JESD51-7, using a four-layer board. For detailed information on package thermal considerations, refer to www.maximintegrated.com/thermal-tutorial.

Electrical Characteristics

($V_{\text{IN}} = V_{\text{OUT(SETPOINT)}} + 500\text{mV}$ or $V_{\text{IN}} = 2.25\text{V}$ whichever is greater, SET = GND, $\overline{\text{SHDN}} = \text{IN}$, $T_{\text{A}} = 0^{\circ}\text{C}$ to $+85^{\circ}\text{C}$, unless otherwise noted. Typical values are at $T_{\text{A}} = +25^{\circ}\text{C}$.)

PARAMETER	SYMBOL	CONDITIONS	MIN	TYP	MAX	UNITS
Input Voltage	V_{IN}		2.25		5.50	V
Input Undervoltage Lockout	V_{UVLO}	Rising, 40mV hysteresis	1.85	2	2.15	V
Output Voltage Accuracy (Preset Mode)	V_{OUT}	$T_{\text{A}} = +25^{\circ}\text{C}$, $I_{\text{OUT}} = 100\text{mA}$	-1.5		+1.5	%
		$T_{\text{A}} = +25^{\circ}\text{C}$, $I_{\text{OUT}} = 1\text{mA}$ to 500mA	-2.5		+2.5	
		$T_{\text{A}} = 0^{\circ}\text{C}$ to $+85^{\circ}\text{C}$, $I_{\text{OUT}} = 1\text{mA}$ to 500mA, $V_{\text{IN}} > V_{\text{OUT}} + 0.5\text{V}$	-3		+3	
Adjustable Output Voltage Range			0.8		4.5	V
SET Voltage Threshold (Adjustable Mode)	V_{SET}	$T_{\text{A}} = +25^{\circ}\text{C}$, $I_{\text{OUT}} = 100\text{mA}$	788		812	mV
		$T_{\text{A}} = +25^{\circ}\text{C}$, $I_{\text{OUT}} = 1\text{mA}$ to 500mA	780		820	
		$T_{\text{A}} = 0^{\circ}\text{C}$ to $+85^{\circ}\text{C}$, $I_{\text{OUT}} = 1\text{mA}$ to 500mA, $V_{\text{IN}} > V_{\text{OUT}} + 0.5\text{V}$	774	800	826	
Maximum Output Current	I_{OUT}		500			mA
Short-Circuit Current Limit	I_{LIM}	$V_{\text{OUT}} = 0\text{V}$	600	1400	2300	mA

Electrical Characteristics (continued)

($V_{IN} = V_{OUT(SETPOINT)} + 500\text{mV}$ or $V_{IN} = 2.25\text{V}$ whichever is greater, SET = GND, $\overline{\text{SHDN}} = \text{IN}$, $T_A = 0^\circ\text{C}$ to $+85^\circ\text{C}$, unless otherwise noted. Typical values are at $T_A = +25^\circ\text{C}$.)

PARAMETER	SYMBOL	CONDITIONS	MIN	TYP	MAX	UNITS
SET Dual Mode™ Threshold			35	80	125	mV
SET Input Bias Current	I_{SET}	$V_{SET} = 0.8\text{V}$	-100		+100	nA
Ground-Pin Current	I_Q	$I_{OUT} = 1\text{mA}$		210	600	μA
		$I_{OUT} = 500\text{mA}$		575		
Dropout Voltage (Note 1)		$I_{OUT} = 500\text{mA}$	$V_{OUT} = 2.25\text{V}$	259	400	mV
			$V_{OUT} = 2.8\text{V}$	201	350	
			$V_{OUT} = 4\text{V}$	147	275	
Line Regulation	ΔV_{LNR}	V_{IN} from ($V_{OUT} + 100\text{mV}$) to 5.5V, $I_{LOAD} = 5\text{mA}$		0	0.125	%/V
Load Regulation	ΔV_{LDR}	$I_{OUT} = 1\text{mA}$ to 500mA		15.5	35	ppm/mA
Output Voltage Noise		10Hz to 1MHz, $C_{OUT} = 10\mu\text{F}$ (ESR < 0.1 Ω)		300		μVRMS
SHUTDOWN						
Shutdown Supply Current	I_{OFF}	$\overline{\text{SHDN}} = \text{GND}$, $V_{IN} = 5.5\text{V}$		0.02	5	μA
$\overline{\text{SHDN}}$ Input Threshold	V_{IH}		1.6			V
	V_{IL}				0.6	
$\overline{\text{SHDN}}$ Input Bias Current	$I_{\overline{\text{SHDN}}}$	$\overline{\text{SHDN}} = \text{GND}$ or IN		10	100	nA
Startup Time	t_{START}	$C_{OUT} = 10\mu\text{F}$, time from $\overline{\text{SHDN}}$ high to POK high		40		μs
POWER-OK						
POK Output Low Voltage	V_{OL}	Sinking 2mA		5	50	mV
Operating Voltage Range for Valid POK Output		Sinking 100 μA	1.0		5.5	V
Output High Leakage Current		$V_{POK} = 5.5\text{V}$			100	nA
Threshold		Rising edge, referred to $V_{OUT(NOMINAL)}$	90	93	96	%
THERMAL PROTECTION						
Thermal-Shutdown Temperature	T_{SHDN}			170		$^\circ\text{C}$
Thermal-Shutdown Hysteresis	ΔT_{SHDN}			20		$^\circ\text{C}$

Dual Mode is a trademark of Maxim Integrated Products, Inc.

Electrical Characteristics

($V_{IN} = V_{OUT(SETPOINT)} + 500\text{mV}$ or $V_{IN} = 2.25\text{V}$ whichever is greater, SET = GND, $\overline{\text{SHDN}} = \text{IN}$, $T_A = -40^\circ\text{C}$ to $+85^\circ\text{C}$, unless otherwise noted. Typical values are at $T_A = +25^\circ\text{C}$.) (Note 2)

PARAMETER	SYMBOL	CONDITIONS	MIN	TYP	MAX	UNITS
Input Voltage	V_{IN}		2.25		5.50	V
Input Undervoltage Lockout	V_{UVLO}	Rising, 40mV hysteresis	1.85		2.15	V
Output Voltage Accuracy (Preset Mode)	V_{OUT}	$I_{OUT} = 1\text{mA}$ to 500mA	-4		+4	%
Adjustable Output Voltage Range			0.8		4.5	V
SET Voltage Threshold (Adjustable Mode)	V_{SET}	$I_{OUT} = 1\text{mA}$ to 500mA	766		834	mV
Maximum Output Current	I_{OUT}		500			mA
Short-Circuit Current Limit	I_{LIM}	$V_{OUT} = 0\text{V}$	600		2500	mA
SET Dual Mode Threshold			35		125	mV
SET Input Bias Current	I_{SET}	$V_{SET} = 0.8\text{V}$	-100		+100	nA
Ground-Pin Current	I_Q	$I_{OUT} = 1\text{mA}$			400	μA
SHUTDOWN						
Shutdown Supply Current	I_{OFF}	$\overline{\text{SHDN}} = \text{GND}$, $V_{IN} = 5.5\text{V}$			5	μA
$\overline{\text{SHDN}}$ Input Threshold	V_{IH}	$2.5\text{V} < V_{IN} < 5.5\text{V}$	1.6			V
	V_{IL}	$2.5\text{V} < V_{IN} < 5.5\text{V}$			0.6	
$\overline{\text{SHDN}}$ Input Bias Current	$I_{\overline{\text{SHDN}}}$	$\overline{\text{SHDN}} = \text{GND}$ or IN			100	nA
POWER-OK						
POK Output Low Voltage	V_{OL}	Sinking 2mA			50	mV
Operating Voltage Range for Valid POK Output		Sinking 100 μA	1.0		5.5	V
Output High Leakage Current		$V_{POK} = 5.5\text{V}$			100	nA
Threshold		Rising edge, referred to $V_{OUT(NOMINAL)}$	89		97	%

Note 1: Dropout voltage is defined as $V_{IN} - V_{OUT}$, when V_{OUT} is 100mV below the value of V_{OUT} and when $V_{IN} = V_{OUT(NOM)} + 0.5\text{V}$. For $2.25\text{V} \leq V_{OUT} \leq 4\text{V}$, dropout voltage limits are linearly interpolated from the values listed. For $V_{OUT} < 4\text{V}$, dropout voltage limit is equal to the value for $V_{OUT} = 4\text{V}$.

Note 2: Specifications to -40°C are guaranteed by design, not production tested.

Typical Operating Characteristics

($V_{OUT} = 3.3V$, $V_{IN} = V_{OUT} + 500mV$, $\overline{SHDN} = IN$, $C_{IN} = 1\mu F$, $C_{OUT} = 10\mu F$, $T_A = +25^\circ C$, unless otherwise noted.)

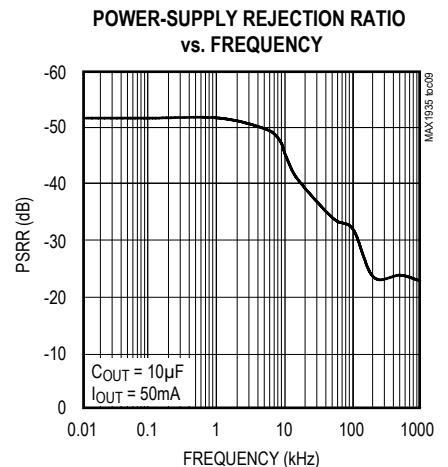
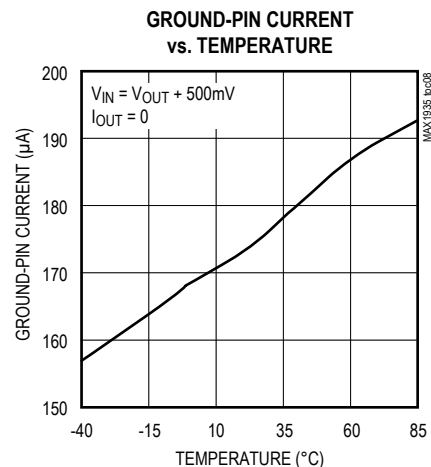
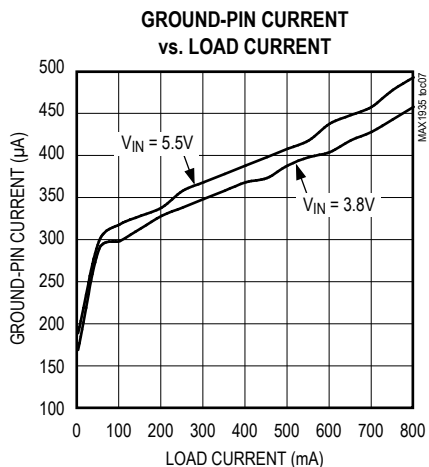
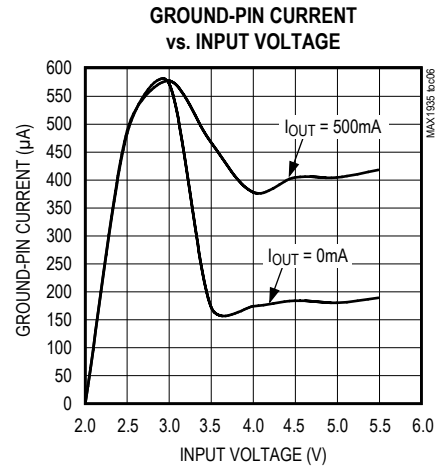
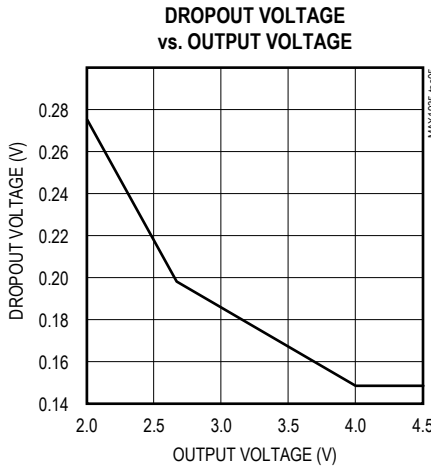
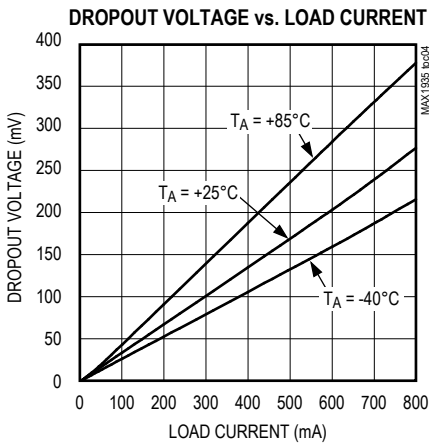
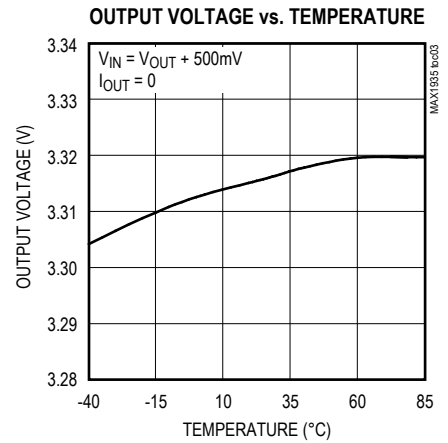
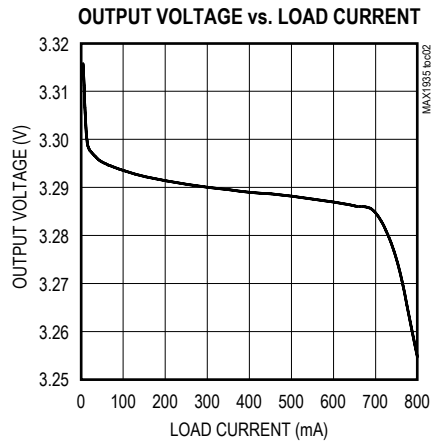
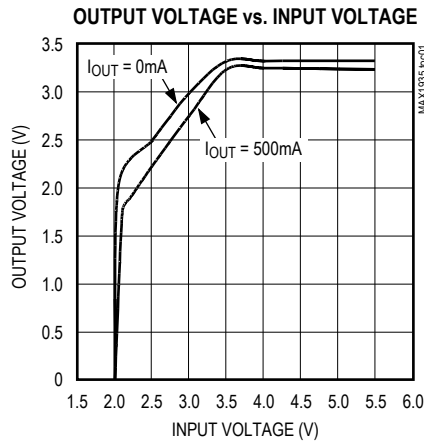

Typical Operating Characteristics (continued)

($V_{OUT} = 3.3V$, $V_{IN} = V_{OUT} + 500mV$, $\overline{SHDN} = IN$, $C_{IN} = 1\mu F$, $C_{OUT} = 10\mu F$, $T_A = +25^\circ C$, unless otherwise noted.)

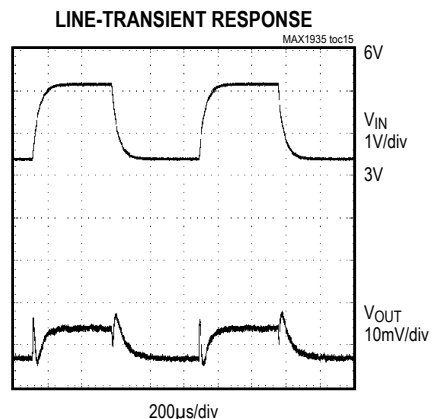
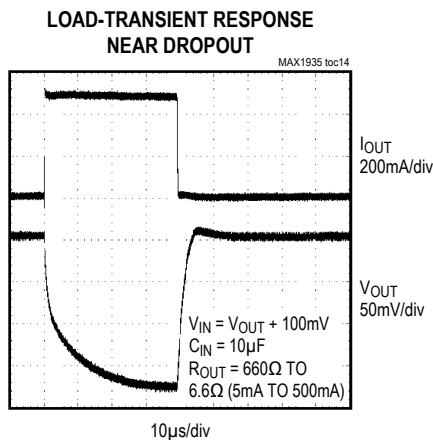
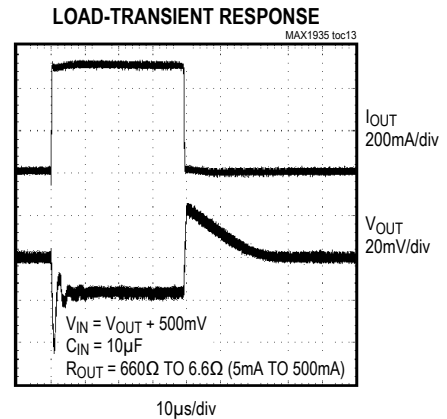
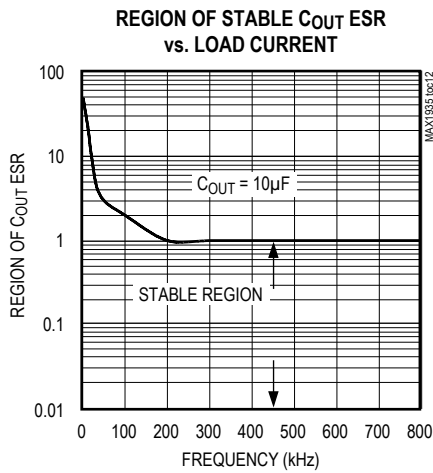
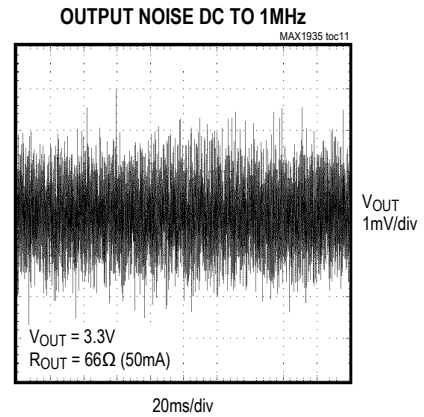
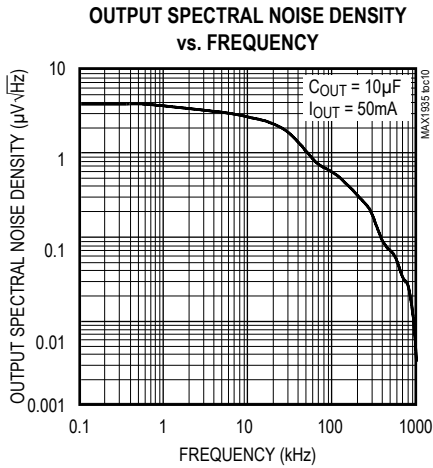

Typical Operating Characteristics (continued)

($V_{OUT} = 3.3V$, $V_{IN} = V_{OUT} + 500mV$, $\overline{SHDN} = IN$, $C_{IN} = 1\mu F$, $C_{OUT} = 10\mu F$, $T_A = +25^\circ C$, unless otherwise noted.)

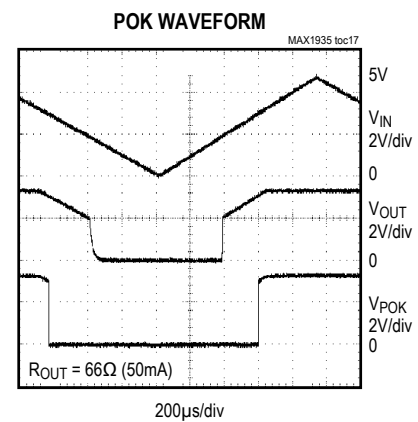
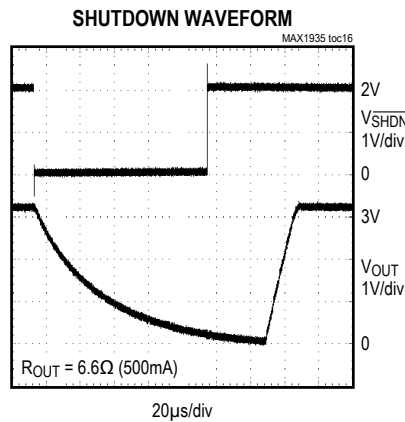

Pin Description

PIN	NAME	FUNCTION
1, 2	IN	Regulator Input. Supply voltage can range from 2.25V to 5.5V. Bypass with a 1µF capacitor to GND (see the <i>Capacitor Selection and Regulation Stability</i> section). Connect both input pins together externally.
3	POK	Open-Drain, Active-Low Power-OK Output. POK remains low while the output voltage (V_{OUT}) is below the POK threshold. Connect a 100kΩ pullup resistor from POK to OUT.
4	\overline{SHDN}	Active-Low Shutdown Input. A logic low at \overline{SHDN} reduces supply current to 0.02µA. In shutdown, the POK output is low. Connect \overline{SHDN} to IN for normal operation.
5	GND	Ground. This pin and the exposed pad also function as a heatsink. Solder both to a large pad or to the circuit-board ground plane to maximize power dissipation.
6	SET	Voltage-Setting Input. Connect SET to GND for preset output. Connect an external resistive voltage-divider from OUT to SET to set the output voltage between 0.8V and 4.5V. The SET regulation voltage is 800mV.
7, 8	OUT	Regulator Output. OUT sources up to 500mA. Bypass OUT with a 10µF low-ESR capacitor to GND. Connect both OUT pins together externally.

Detailed Description

The MAX1935 is a low-dropout, low-quiescent-current linear regulator. The device supplies loads up to 500mA and is available with preset output voltages. As illustrated in Figure 1, the MAX1935 includes a 0.8V reference, error amplifier, P-channel pass transistor, and internal feedback voltage-divider.

The reference is connected to the error amplifier, which compares it with the feedback voltage and amplifies the difference. If the feedback voltage is lower than the reference voltage, the pass-transistor gate is pulled lower, which allows more current to pass to the output increasing the output voltage. If the feedback voltage is too high, the pass-transistor gate is pulled up, allowing less current to pass to the output.

The output voltage is fed back through either an internal resistive voltage-divider connected to OUT or an external resistor network connected to SET. The dual-mode comparator examines V_{SET} and selects the feedback path. If V_{SET} is below 35mV, the internal feedback path is used, and the output is regulated to the factory-preset voltage. Additional blocks include an output current limiter, thermal sensor, and shutdown logic.

Internal P-Channel Pass Transistor

The MAX1935 features a 0.4Ω P-channel MOSFET pass transistor. Unlike similar designs using PNP pass transistors, P-channel MOSFETs require no base drive, which reduces operating current. PNP-based regulators also waste considerable current in dropout when the pass transistor saturates, and use high base-drive currents under large loads. The MAX1935 does not suffer from these problems.

Output Voltage Selection

The MAX1935's dual-mode operation allows operation in either a preset voltage mode or an adjustable mode. Connect SET to GND to select the preset output voltage. The two-digit part number suffix identifies the output voltage. For example, the MAX1935ETA33 has a preset 3.3V output voltage. The output voltage can also be adjusted by connecting a voltage-divider from OUT to SET (Figure 2). Select R2 in the 25kΩ to 100kΩ range. Calculate R1 with the following equation:

$$R1 = R2 [(V_{OUT} / V_{SET}) - 1]$$

where $V_{SET} = 0.8V$, and V_{OUT} can range from 0.8V to 4.5V.

Shutdown

Drive \overline{SHDN} low to enter shutdown. During shutdown, the output is disconnected from the input, and supply current

drops to 0.02μA. When in shutdown, POK pulls low. The capacitance and load at OUT determine the rate at which V_{OUT} decays. \overline{SHDN} can be pulled as high as 6V, regardless of the input and output voltage.

Power-OK Output

The POK output pulls low when OUT is less than 93% of the nominal regulation voltage. Once OUT exceeds 93% of the nominal voltage, POK goes high impedance. POK is an open-drain N-channel output. To obtain a logic voltage output, connect a pullup resistor from POK to OUT. A 100kΩ resistor works well for most applications. POK can be used to signal a microcontroller (μC), or drive an external LED to indicate power failure. When the MAX1935 is shutdown, POK is held low independent of the output voltage. If unused, leave POK grounded or unconnected.

Current Limit

The MAX1935 monitors and controls the pass transistor's gate voltage, limiting the output current to 1.4A (typ). The output can be shorted to ground for an indefinite period of time without damaging the part.

Thermal-Overload Protection

Thermal-overload protection limits total power dissipation in the MAX1935. When the junction temperature exceeds $T_J = +170^\circ C$, a thermal sensor turns off the pass transistor, allowing the device to cool. The thermal sensor turns the pass transistor on again after the junction temperature cools by $+20^\circ C$, resulting in a pulsed output during continuous thermal-overload conditions. Thermal-overload protection protects the MAX1935 in the event of fault conditions. For continuous operation, do not exceed the absolute maximum junction-temperature rating of $T_J = +150^\circ C$.

Operating Region and Power Dissipation

The MAX1935's maximum power dissipation depends on the thermal resistance of the IC package and circuit board, the temperature difference between the die junction and ambient air, and the rate of air flow. The power dissipated in the device is $P = I_{OUT} \times (V_{IN} - V_{OUT})$. The maximum allowed power dissipation is 1.95W or:

$$P_{MAX} = (T_{J(MAX)} - T_A) / (\theta_{JC} + \theta_{CA})$$

where $T_J - T_A$ is the temperature difference between the MAX1935 die junction and the surrounding air, θ_{JC} is the thermal resistance from the junction to the case, and θ_{CA} is the thermal resistance from the case through the PC board, copper traces, and other materials to the surrounding air. The MAX1935 package features an exposed thermal pad on its underside. This pad lowers the package's

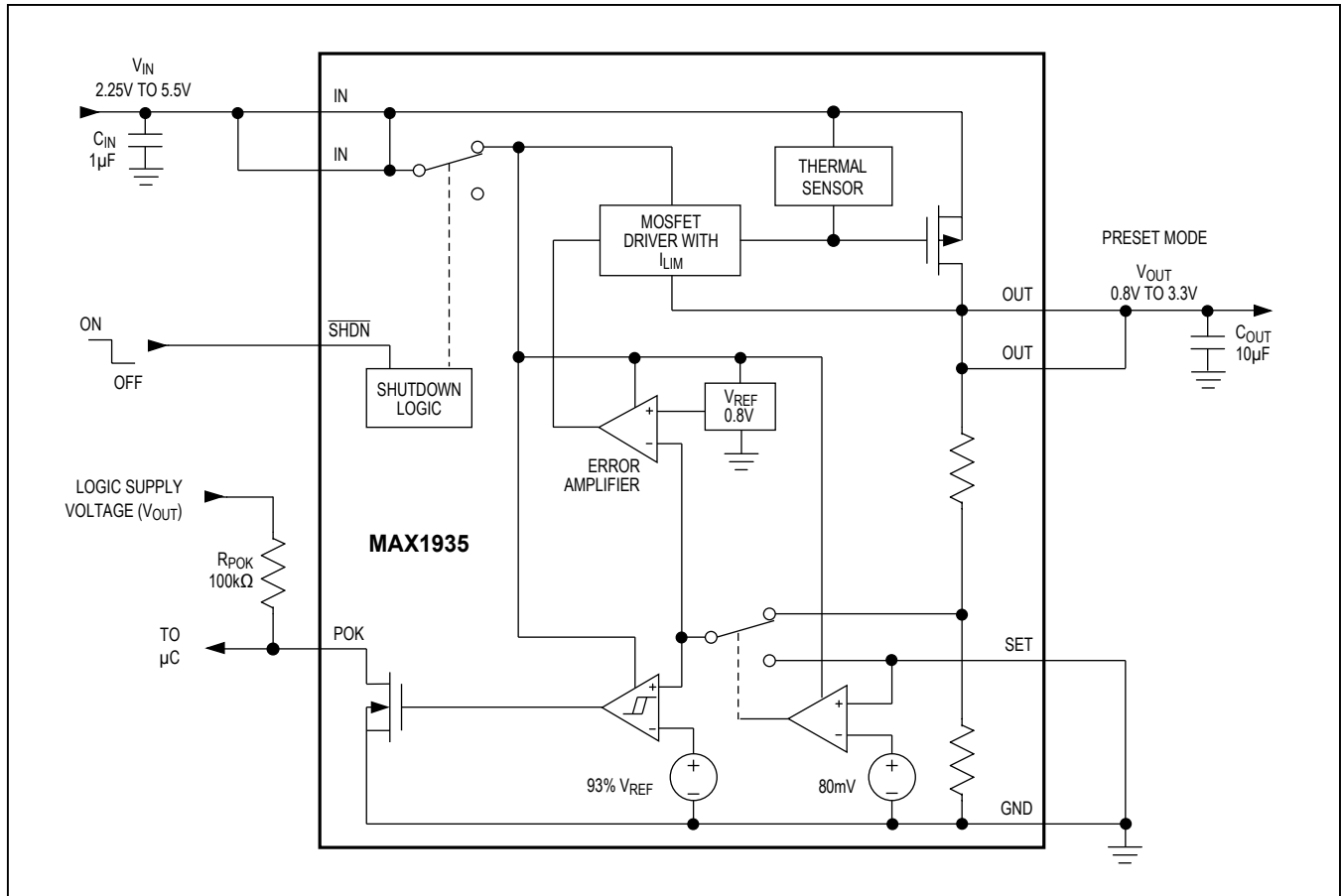

Figure 1. Functional Diagram

thermal resistance by providing a direct heat conduction path from the die to the PC board. Connect the exposed backside pad and GND to the system ground using a large pad or ground plane, or multiple vias to the ground plane layer.

The MAX1935 delivers up to 0.5A and operates with input voltages up to 5.5V, but not simultaneously. High output currents can only be sustained when input-output differential is within the limits outlined.

Applications Information

Capacitor Selection and Regulator Stability

Connect a 1µF capacitor between IN and ground and a 10µF low equivalent series-resistance (ESR) capacitor between OUT and ground. The input capacitor (C_{IN}) lowers the source impedance of the input supply. Reduce noise and improve load-transient response, stability, and

power-supply rejection by using larger output capacitors. The output capacitor's (C_{OUT}) ESR affects stability and output noise. Use output capacitors with an ESR of 0.1Ω or less to ensure stability and optimum transient response. Surface-mount ceramic capacitors have very low ESR and are commonly available in values up to 10µF. Connect C_{IN} and C_{OUT} as close to the MAX1935 as possible.

Noise, PSRR, and Transient Response

The MAX1935 is designed to operate with low drop-out voltages and low quiescent currents, while still maintaining good noise, transient response, and AC rejection. See the [Typical Operating Characteristics](#) for a plot of Power-Supply Rejection Ratio (PSRR) vs. Frequency. When operating from noisy sources, improved supply-noise rejection and transient response can be achieved by increasing the values of the input and output bypass capacitors and through passive-filtering techniques. The MAX1935 load-transient response graphs

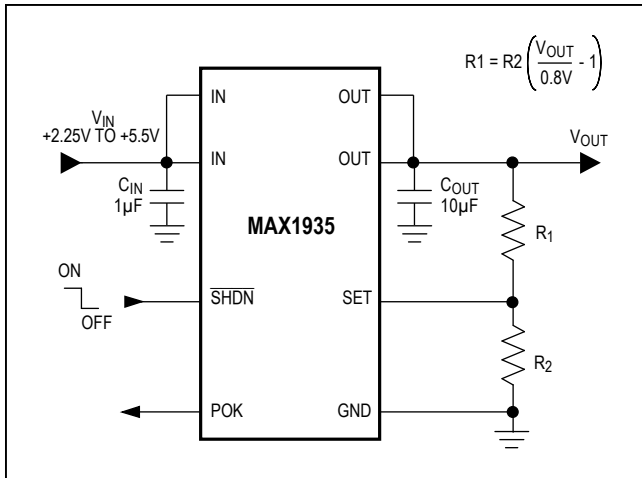

Figure 2. Adjustable Output Using External Feedback Resistors

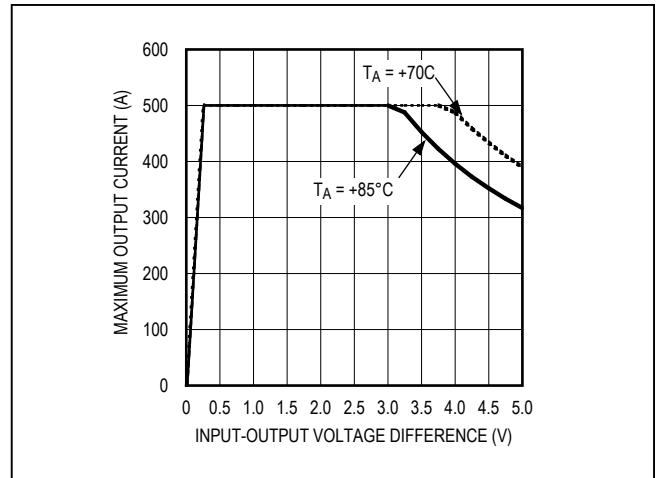

Figure 3. Power Operating Regions: Maximum Output Current vs. Input-Output Voltage Difference

(see the [Typical Operating Characteristics](#)) show two components of the output response: a DC shift from the output impedance due to the load current change, and the transient response. A typical transient overshoot for a step change in the load current from 5mA to 500mA is 40mV. Increasing the output capacitor's value and decreasing the ESR attenuates the overshoot.

Input-Output (Dropout) Voltage

A regulator's minimum input-to-output voltage differential (dropout voltage) determines the lowest usable supply voltage. In battery-powered systems, this determines the useful end-of-life battery voltage. Because the MAX1806 uses a P-channel MOSFET pass transistor, its dropout voltage is a function of drain-to-source on-resistance ($R_{DS(ON)}$) multiplied by the load current (see the [Typical Operating Characteristics](#)):

$$V_{DROPOUT} = V_{IN} - V_{OUT} = R_{DS(ON)} \times I_{OUT}$$

Chip Information

TRANSISTOR COUNT: 949

Revision History

REVISION NUMBER	REVISION DATE	DESCRIPTION	PAGES CHANGED
0	10/02	Initial release	—
1	7/20	Update to <i>Electrical Characteristics</i> table, <i>Detailed Description</i> , and all package information	All

For pricing, delivery, and ordering information, please visit Maxim Integrated's online storefront at <https://www.maximintegrated.com/en/storefront/storefront.html>.

Maxim Integrated cannot assume responsibility for use of any circuitry other than circuitry entirely embodied in a Maxim Integrated product. No circuit patent licenses are implied. Maxim Integrated reserves the right to change the circuitry and specifications without notice at any time. The parametric values (min and max limits) shown in the *Electrical Characteristics* table are guaranteed. Other parametric values quoted in this data sheet are provided for guidance.

Mouser Electronics

Authorized Distributor

Click to View Pricing, Inventory, Delivery & Lifecycle Information:

[Maxim Integrated:](#)

[MAX1935ETA+T](#) [MAX1935ETA15+T](#)