

# TrEOS ESD protection for Automotive Infotainment & SerDes

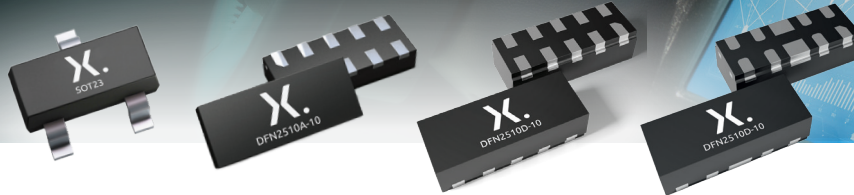

Nexperia's TrEOS Protection offers the ideal combination of low capacitance, low clamping voltage and high ESD robustness for your design. Helping safeguard 10 Gbps data lines systems in automotive applications against ESD and surge events while being AEC-Q101 qualified.

## Automotive TrEOS Protection

### Optimizing the three pillars of ESD protection:

1. **Low capacitance** for highest signal integrity down to 0.2 pF
2. **Low clamping & trigger** for enhanced system protection down to  $0.4 \Omega (R_{dyn})$
3. **High robustness** against ESD up to 15 kV & Surge up to 7 A at 8/20  $\mu$ s

### The ideal combination for every design

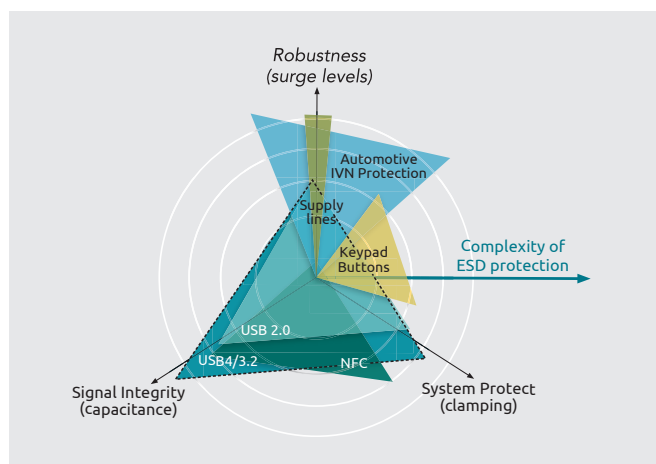

## Functions & Applications

- › Infotainment applications: USB 2.0, SuperSpeed USB 3.2 at 10 Gps, HDMI, HDBaseT
- › Automotive A/V monitors, display and cameras
- › SerDes: GMSL, FPD-Link, LVDS, APIX

## Key features

- › Available in specifications between 3.3 V and 5 V  $V_{RWM}$
- › Extremely fast switching time under 1 ns
- › Snap-back technology allows for lowest clamping voltage
- › Suitable for up to ~10Gbps per line pair
- › Reliable protection for sensitive transceiver SoCs
- › Ultra-low dynamic resistance/ capacitance combination
- › Exceeding IEC61000-4-2 level 4, offering IEC61000-4-5 grade robustness
- › Available in automotive grade leaded and leadless packages SOT23, DFN2510A-10 (SOT1176) and DFN2510D-10 (SOT1165D, SOT1176D). More are in development, e.g. DFN1006BD-2 with side-wettable flanks

**nexperia**

EFFICIENCY WINS.

## Nexperia TrEOS portfolio for high-speed data-lines

Our TrEOS family is composed of two subsets of devices which can be employed together or separately:

- › Extremely high surge robustness devices are designed to be placed between the connector and AC capacitor to protect the decoupling capacitor and transceiver against possible peak pulses (up to 20 A).
- › Extremely low peak voltages devices are designed to be placed between the capacitor and the device, offering industry-leading low-trigger voltage to maximize system-level protection ( $V_{t1}$  as low as 3.5 V).



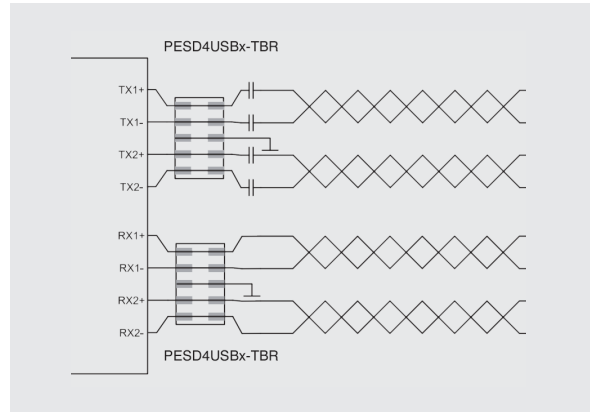

Combining a protection device from both subsets is suggested, to achieve ultimate ESD protection.

The AEC-Q101-qualified automotive TrEOS ESD protection devices parts combine extremely low capacitance ensuring high signal integrity, extremely low clamping, and high robustness for modern automotive interfaces. Specific automotive applications include infotainment, multimedia and ADAS systems featuring USB2.0, HDMI, LVDS, SerDes and SD-card interfaces. With TrEOS technology, capacitance is kept down to 0.2 pF, clamping voltage is just 1.5 V and devices can withstand surge and ESD pulses up to 7 A 8/20  $\mu$ s. This industry-leading performance in all areas is delivered in the extensively-proven SOT23, DFN2510A-10 (SOT1176) and DFN2510D-10 (SOT1165D, SOT1176D) package. Nexperia will continue to offer TrEOS ESD protection in more leadless packages, e.g. the 2-pin DFN1006BD-2 with side-wettable flanks.



USB 3.2 ESD Protection for Automotive

## Portfolio overview

Product	Package	Configuration	$V_{RWM}$ (V)	Capacitance max (pF)	ESD Robustness (kV)
PESD2USB3UV-T	 SOT23 2.9 x 1.3 x 1.0 mm	Unidirectional	3.3 V	1 pF	18 kV
PESD2USB3UX-T			3.3 V	0.7 pF	8 kV
PESD2USB5UV-T			5 V	0.9 pF	22 kV
PESD2USB5UX-T			5 V	0.6 pF	8 kV
PESD4USB3U-TBR	 DFN2510A-10(SOT1176) 2.5 x 1.0 x 0.5 mm	Unidirectional	3.3V	0.34 pF	15 kV
PESD4USB5U-TBR			5 V		
PESD4USB3B-TBR		Bidirectional	3.3 V	0.25 pF	
PESD4USB5B-TBR			5 V		
PESD4USB3U-TTS	 DFN2510D-10 (SOT1165D) 2.5 x 1.0 x 0.75 mm SWF for AOI	Unidirectional	3.3 V	0.34 pF	15 kV
PESD4USB5U-TTS			5 V		
PESD4USB3B-TTS		Bidirectional	3.3 V	0.25 pF	
PESD4USB5B-TTS			5 V		
PESD4USB3U-TBS	 DFN2510D-10 (SOT1176D) 2.5 x 1.0 x 0.75 mm SWF for AOI	Unidirectional	3.3 V	0.34 pF	15 kV
PESD4USB5U-TBS			5 V		
PESD4USB3B-TBS		Bidirectional	3.3 V	0.25 pF	
PESD4USB5B-TBS			5 V		

## Package details

Automotive TrEOS solutions are available in automotive grade, extreme-robustness leaded SMD and leadless DFN plastic packages.

Browse our full portfolio: <https://www.nexperia.com/automotive-infotainment-serdes>

© 2021 Nexperia B.V.

All rights reserved. Reproduction in whole or in part is prohibited without the prior written consent of the copyright owner. The information presented in this document does not form part of any quotation or contract, is believed to be accurate and reliable and may be changed without notice. No liability will be accepted by the publisher for any consequence of its use. Publication thereof does not convey nor imply any license under patent- or other industrial or intellectual property rights.

Date of release:

April 2021

Printed:

In the Netherlands

# Mouser Electronics

Authorized Distributor

Click to View Pricing, Inventory, Delivery & Lifecycle Information:

[Nexperia:](#)

[PESD2USB3UV-TR](#) [PESD2USB3UX-TR](#) [PESD2USB5UV-TR](#) [PESD2USB5UX-TR](#)