

THS4001 270-MHz HIGH-SPEED AMPLIFIER

SLOS206A– DECEMBER 1997 – REVISED MARCH 1999

- **Very High Speed**
 - 270 MHz Bandwidth (Gain = 1, –3 dB)
 - 400 V/μsec Slew Rate
 - 40-ns Settling Time (0.1%)
- **High Output Drive, $I_O = 100$ mA**
- **Excellent Video Performance**
 - 60 MHz Bandwidth (0.1 dB, G = 1)
 - 0.04% Differential Gain
 - 0.15° Differential Phase
- **Very Low Distortion**
 - THD = –72 dBc at $f = 1$ MHz
- **Wide Range of Power Supplies**
 $V_{CC} = \pm 2.5$ V to ± 15 V,
 $I_{CC} = 7.5$ mA
- **Evaluation Module Available**

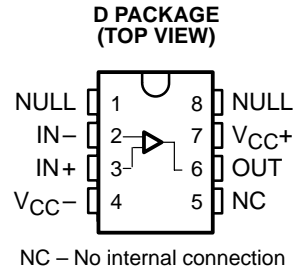

description

The THS4001 is a very high-performance, voltage-feedback operational amplifier especially suited for a wide range of video applications. The device is specified to operate over a wide range of supply voltages from ± 15 V to ± 2.5 V. With a bandwidth of 270 MHz, a slew rate of over 400 V/μs, and settling times of less than 30 ns, the THS4001 offers the unique combination of high performance in an easy to use voltage feedback configuration over a wide range of power supply voltages.

The THS4001 is stable at all gains for both inverting and noninverting configurations. It has a high output drive capability of 100 mA and draws only 7.5 mA of quiescent current. Excellent professional video results can be obtained with the differential gain/phase performance of 0.04%/0.15° and 0.1 dB gain flatness to 60 MHz. For applications requiring low distortion, the THS4001 is ideally suited with total harmonic distortion of –72 dBc at $f = 1$ MHz.

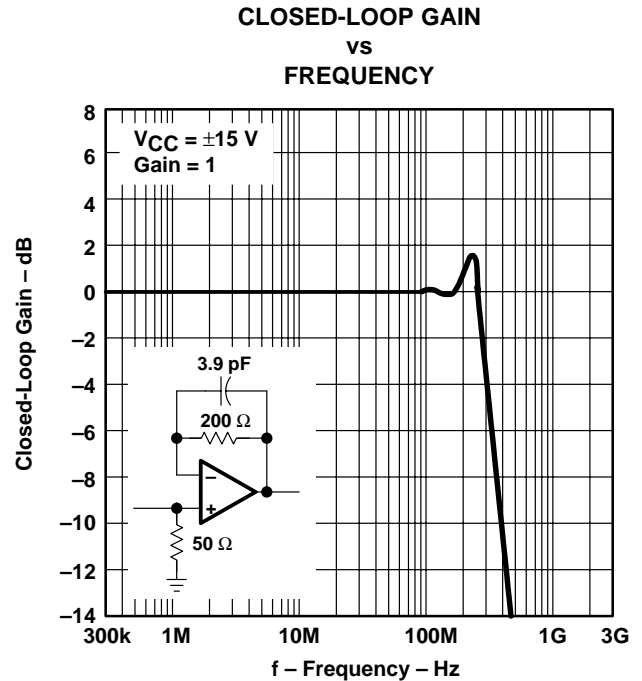

HIGH-SPEED AMPLIFIER FAMILY

DEVICE	ARCH.		SUPPLY VOLTAGE			BW (MHz)	SR (V/μs)	THD $f = 1$ MHz (dB)	t_s 0.1% (ns)	DIFF. GAIN	DIFF. PHASE	V_n (nV/√Hz)
	VFB	CFB	5 V	±5 V	±15 V							
THS3001		•		•	•	420	6500	–96	40	0.01%	0.02°	1.6
THS4001	•		•	•	•	270	400	–72	40	0.04%	0.15°	12.5
THS4031/32	•			•	•	100	100	–72	60	0.02%	0.03°	1.6
THS4061/62	•			•	•	180	400	–72	40	0.02%	0.02°	14.5



Please be aware that an important notice concerning availability, standard warranty, and use in critical applications of Texas Instruments semiconductor products and disclaimers thereto appears at the end of this data sheet.

PRODUCTION DATA information is current as of publication date. Products conform to specifications per the terms of Texas Instruments standard warranty. Production processing does not necessarily include testing of all parameters.

 **TEXAS
INSTRUMENTS**

POST OFFICE BOX 655303 • DALLAS, TEXAS 75265

Copyright © 1999, Texas Instruments Incorporated

recommended operating conditions

		MIN	TYP	MAX	UNIT
Supply voltage, V_{CC}	Dual supply	±2.5		±16	V
	Single supply	5		32	
Quiescent current, I_{CC}	±15 V		7.8	9.5	mA
	±5 V, ±2.5 V		6.7	8	
Operating free-air temperature, T_A	C suffix	0		70	°C
	I suffix	-40		85	

electrical characteristics, $V_{CC} = \pm 15$ V, $R_L = 150 \Omega$, $T_A = 25^\circ\text{C}$ (unless otherwise noted)

PARAMETER	TEST CONDITIONS	V_{CC}	MIN	TYP	MAX	UNIT
Differential gain error	Gain = 2, $R_L = 150 \Omega$, $f = 3.58$ MHz	±15 V		0.04%		
		±5 V		0.01%		
±15 V			0.15°			
±5 V			0.08°			
V_{IO} Input offset voltage	$T_A = 25^\circ\text{C}$	±15 V,		2	8	mV
	$T_A = \text{full range}$	±5 V			10	
I_{IB} Input bias current	$T_A = 25^\circ\text{C}$	±15 V,		2.6	5	µA
	$T_A = \text{full range}$	±5 V			6	
I_{OS} Input offset current	$T_A = 25^\circ\text{C}$	±15 V,		35	200	nA
	$T_A = \text{full range}$	±5 V			500	
Open-loop gain	$V_O = \pm 10$ V, $R_L = 1$ kΩ	$T_A = 25^\circ\text{C}$	±15 V	5	10	V/mV
		$T_A = \text{full range}$		3		
	$V_O = \pm 2.5$ V, $R_L = 500 \Omega$	$T_A = 25^\circ\text{C}$	±5 V	3	6	
		$T_A = \text{full range}$		2		
CMRR Common-mode rejection ratio	$V_{(CM)} = \pm 12$ V	$T_A = 25^\circ\text{C}$	±15 V	85	100	dB
		$T_A = \text{full range}$		75		
PSRR Power supply rejection ratio	$T_A = 25^\circ\text{C}$	±15 V,		75	85	dB
	$T_A = \text{full range}$	±5 V		70		
V_{ICR} Common-mode input voltage range		±15 V	13.5 to -13	14.8 to -14		V
		±5 V	3.6 to -2.7	4.4 to -3.6		
V_O Output voltage swing	$R_L = 500 \Omega$	±15 V	±13	±13.5		V
		±5 V	±3.3	±3.8		
		±2.5 V	±0.8	±1.3		
I_O Output current	Gain = 2, $R_L = 20 \Omega$	±15 V	50	100		mA
		±5 V	50	100		
		±2.5 V	50	100		
THD Total harmonic distortion	$V_I = 1$ V _(PP) , $f = 1$ MHz	±15 V		-72		dBc
R_I Input resistance				10		MΩ
C_I Input capacitance				1.5		pF
R_O Output resistance	Open loop			10		Ω

THS4001

270-MHz HIGH-SPEED AMPLIFIER

SLOS206A–DECEMBER 1997 – REVISED MARCH 1999

operating characteristics, $V_{CC} = \pm 15\text{ V}$, $R_L = 150\ \Omega$, $T_A = 25^\circ\text{C}$ (unless otherwise noted)

PARAMETER	TEST CONDITIONS	V_{CC}	MIN	TYP	MAX	UNIT
Slew rate	Gain = -1	$\pm 15\text{ V}$		400		$\text{V}/\mu\text{s}$
		$\pm 5\text{ V}$		400		
		$\pm 2.5\text{ V}$		350		
Settling time to 0.1%	10 V step (0 to 10 V), Gain = -1	$\pm 15\text{ V}$		40		ns
	-2.5 V to 2.5 V step, Gain = -1	$\pm 5\text{ V}$		30		
-3 dB Bandwidth	Gain = +1, $R_f = 150\ \Omega$	$\pm 15\text{ V}$		270		MHz
		$\pm 5\text{ V}$		220		
		$\pm 2.5\text{ V}$		180		
	Gain = -1, $R_f = 150\ \Omega$	$\pm 15\text{ V}$		80		MHz
		$\pm 5\text{ V}$		75		
		$\pm 2.5\text{ V}$		70		
Bandwidth for 0.1 dB flatness	Gain = +1	$\pm 15\text{ V}$		60		MHz
		$\pm 5\text{ V}$		50		
		$\pm 2.5\text{ V}$		40		
V_n	Equivalent input noise voltage	$f = 10\text{ kHz}$	$\pm 15\text{ V}$, $\pm 5\text{ V}$	12.5		$\text{nV}/\sqrt{\text{Hz}}$
I_n	Equivalent input noise current	$f = 10\text{ kHz}$	$\pm 15\text{ V}$, $\pm 5\text{ V}$	1.5		$\text{pA}/\sqrt{\text{Hz}}$

TYPICAL CHARACTERISTICS

Table of Graphs

		FIGURE	
I_{IB}	Input bias current	vs Free-air temperature	1
V_{IO}	Input offset voltage	vs Free-air temperature	2
	Open-loop gain	vs Frequency	3
	Phase	vs Frequency	3
	Differential gain	vs DC voltage	4, 5
	Differential phase	vs DC voltage	4, 5
	Closed-loop gain	vs Frequency	6, 7
CMRR	Common-mode rejection ratio	vs Frequency	8
PSRR	Power-supply rejection ratio	vs Frequency	9
		vs Free-air temperature	10
$V_{O(PP)}$	Output voltage swing	vs Supply voltage	11
		vs Load resistance	12
	Bandwidth (-3 dB)	vs Feedback resistance	13, 14
I_{CC}	Supply current	vs Supply voltage	15
		vs Free-air temperature	16
E_{nv}	Noise spectral density	vs Frequency	17
THD	Total harmonic distortion	vs Frequency	18



TYPICAL CHARACTERISTICS

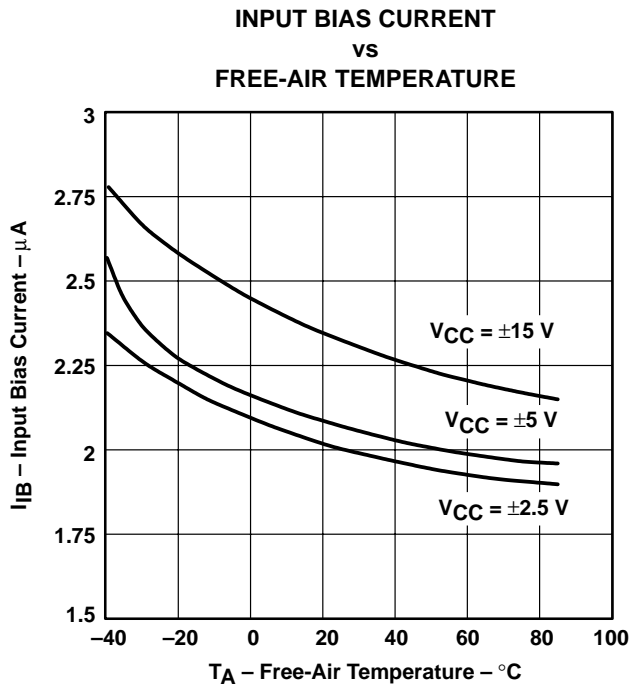

Figure 1

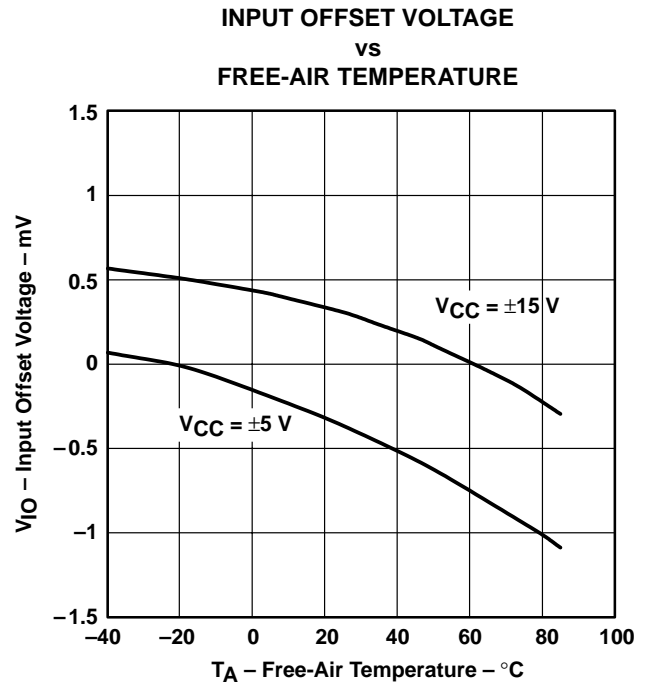

Figure 2

**OPEN-LOOP GAIN AND PHASE
vs
FREQUENCY**

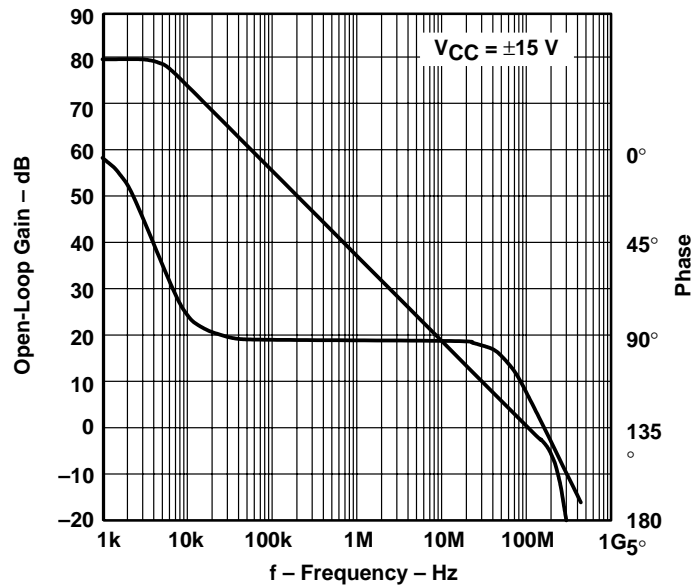

Figure 3

THS4001
270-MHz HIGH-SPEED AMPLIFIER

SLOS206A- DECEMBER 1997 - REVISED MARCH 1999

TYPICAL CHARACTERISTICS

**DIFFERENTIAL GAIN AND
DIFFERENTIAL PHASE
vs
DC VOLTAGE**

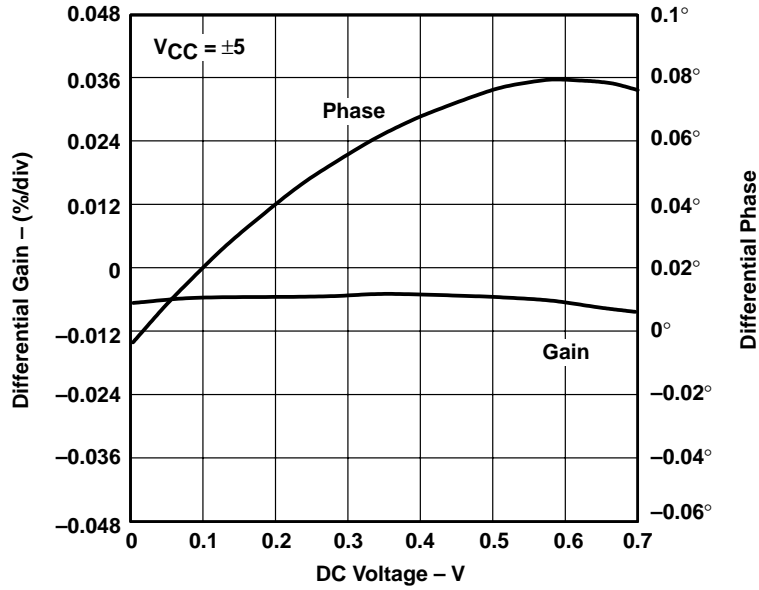

Figure 4

**DIFFERENTIAL GAIN AND
DIFFERENTIAL PHASE
vs
DC VOLTAGE**

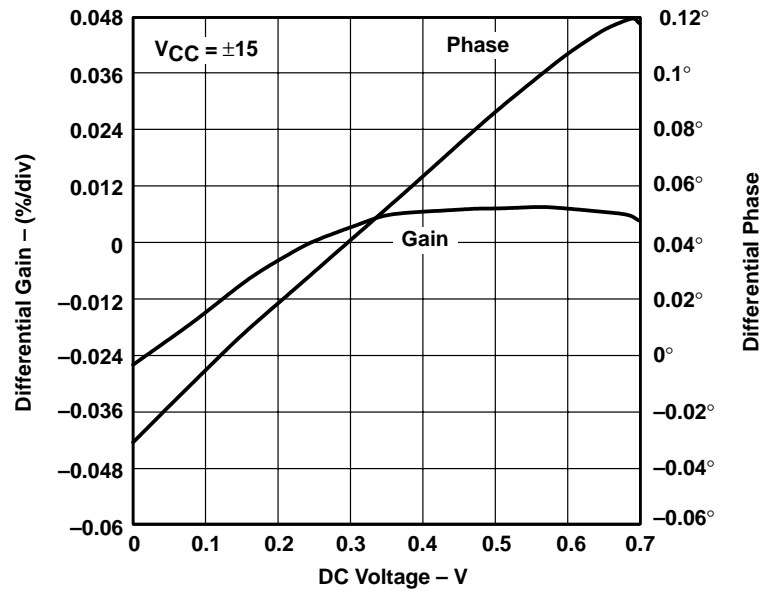

Figure 5



TYPICAL CHARACTERISTICS

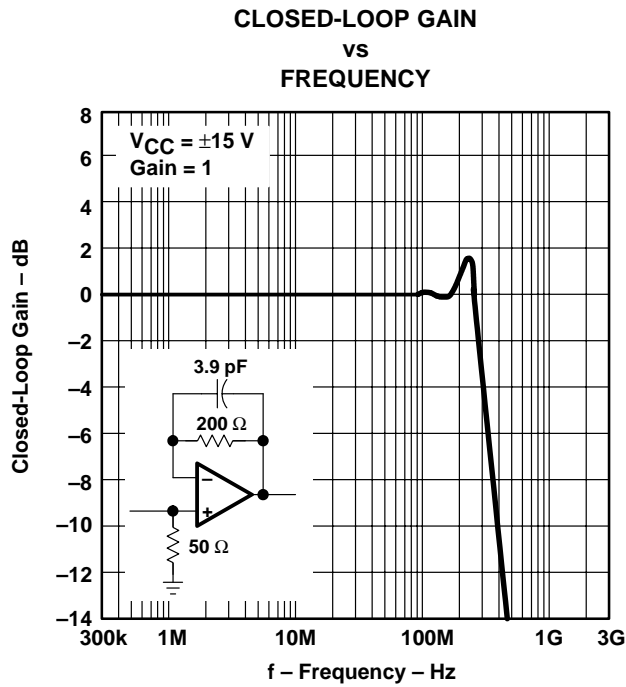

Figure 6

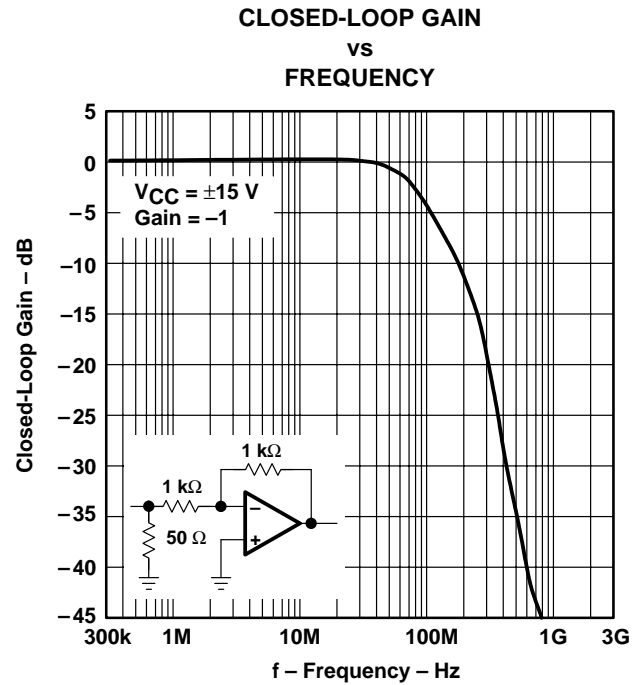

Figure 7

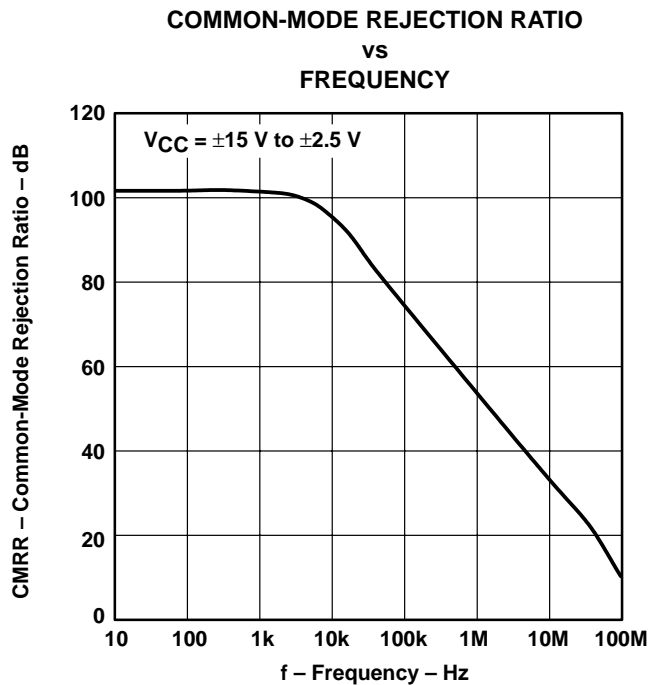

Figure 8

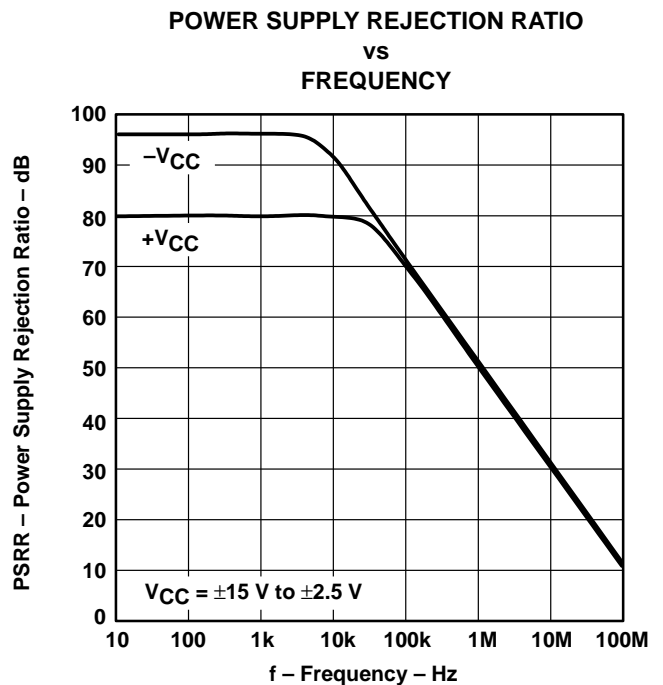

Figure 9

TYPICAL CHARACTERISTICS

POWER SUPPLY REJECTION RATIO
vs
FREE-AIR TEMPERATURE

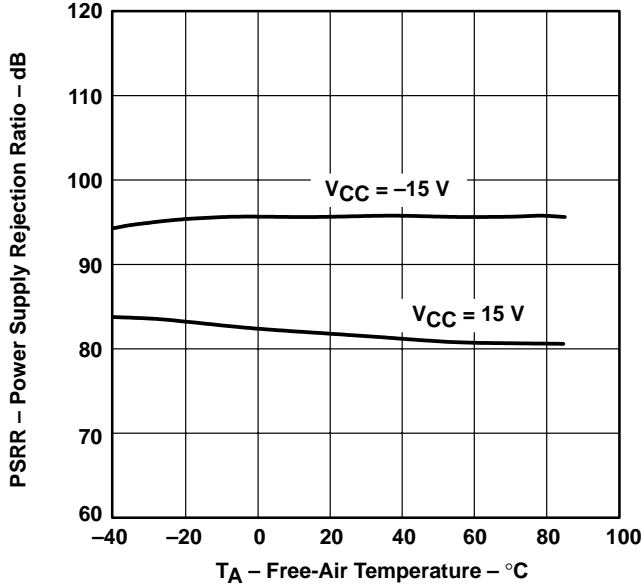

Figure 10

OUTPUT VOLTAGE SWING
vs
SUPPLY VOLTAGE

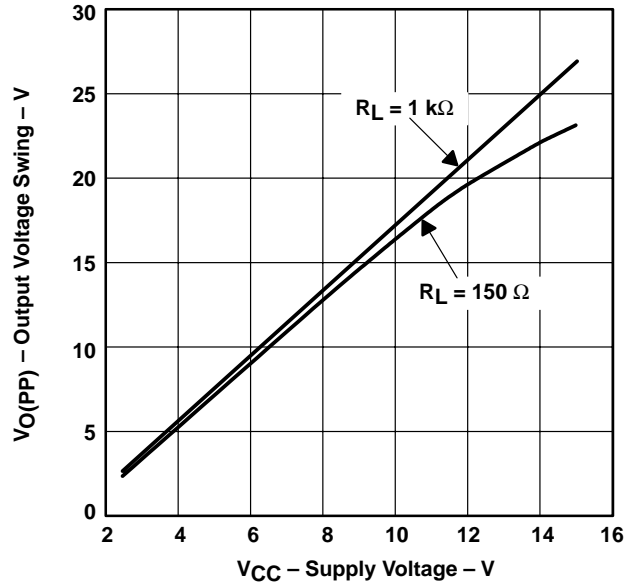

Figure 11

OUTPUT VOLTAGE SWING
vs
LOAD RESISTANCE

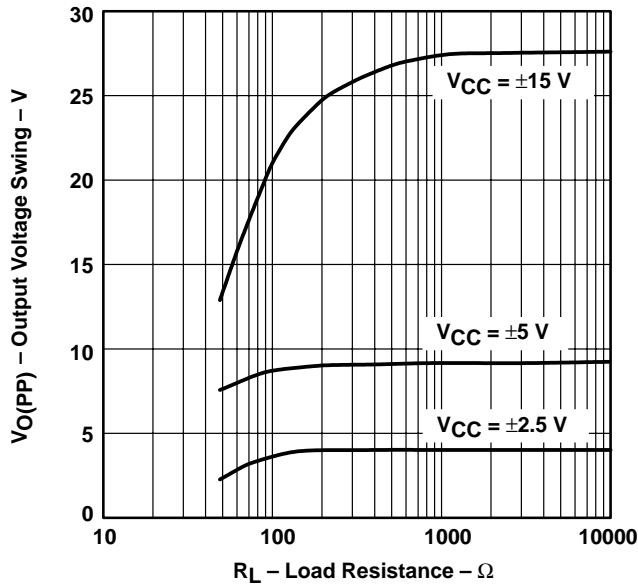

Figure 12

BANDWIDTH (-3 dB)
vs
FEEDBACK RESISTANCE

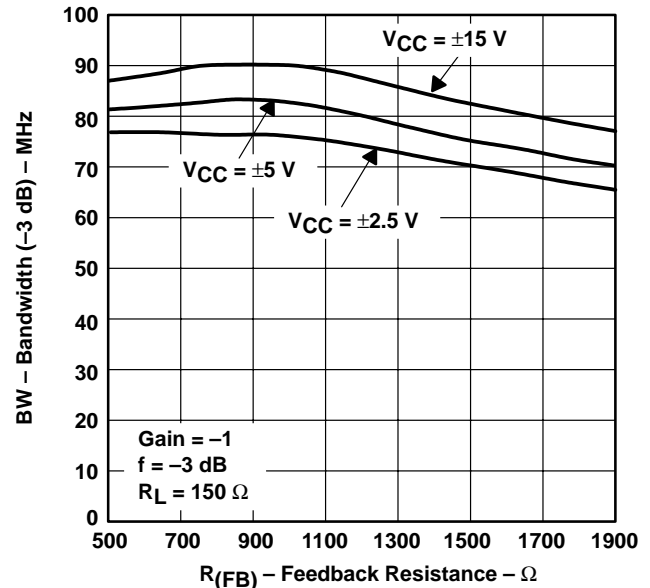

Figure 13

TYPICAL CHARACTERISTICS

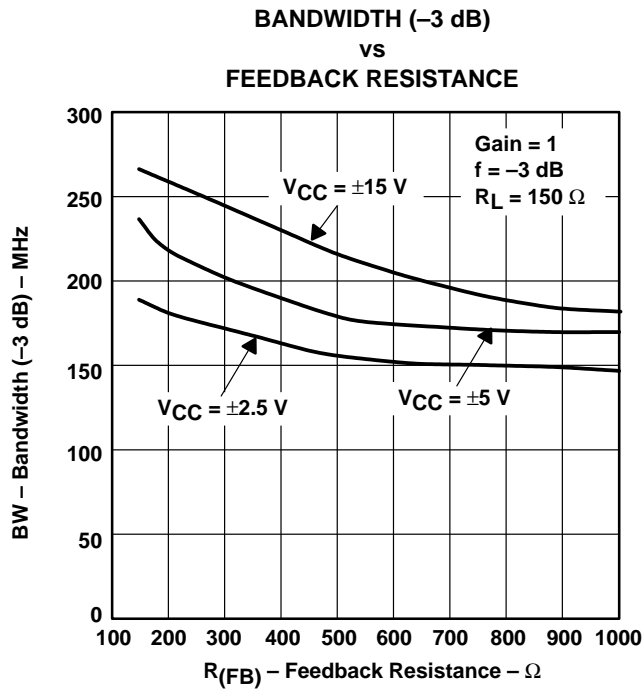

Figure 14

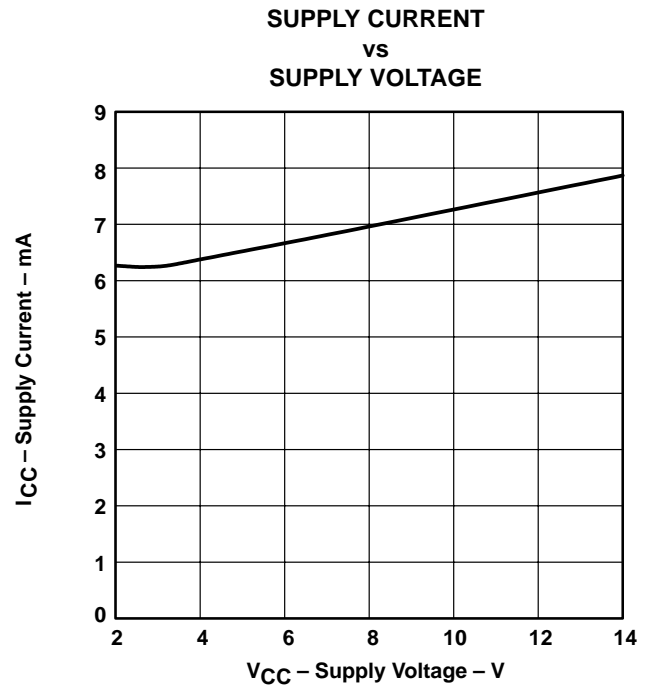

Figure 15

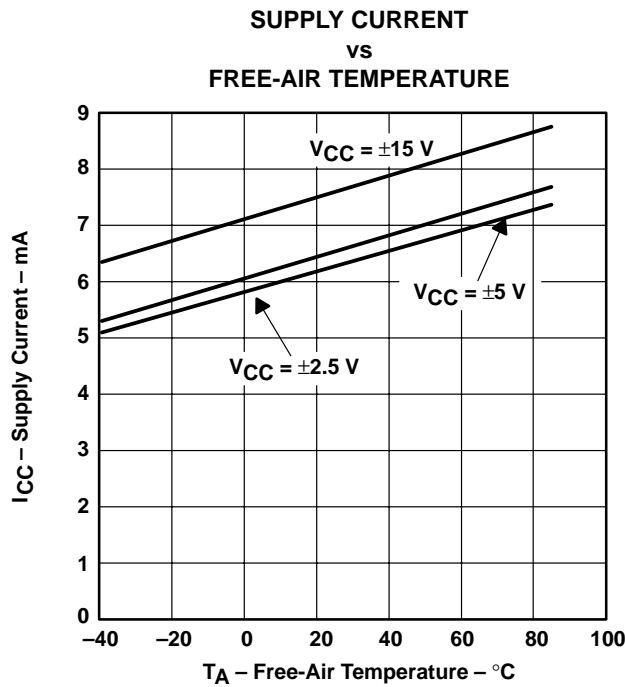

Figure 16

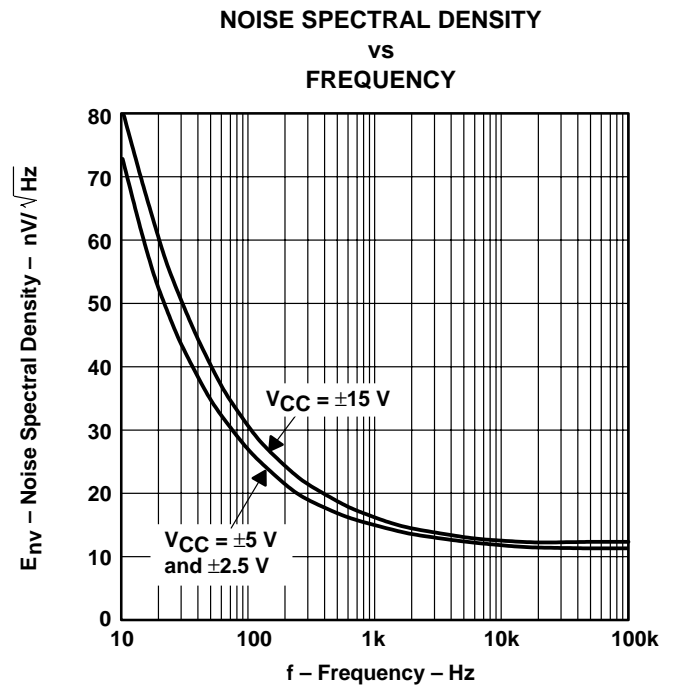

Figure 17

THS4001 270-MHz HIGH-SPEED AMPLIFIER

SLOS206A- DECEMBER 1997 - REVISED MARCH 1999

TYPICAL CHARACTERISTICS

TOTAL HARMONIC DISTORTION vs FREQUENCY

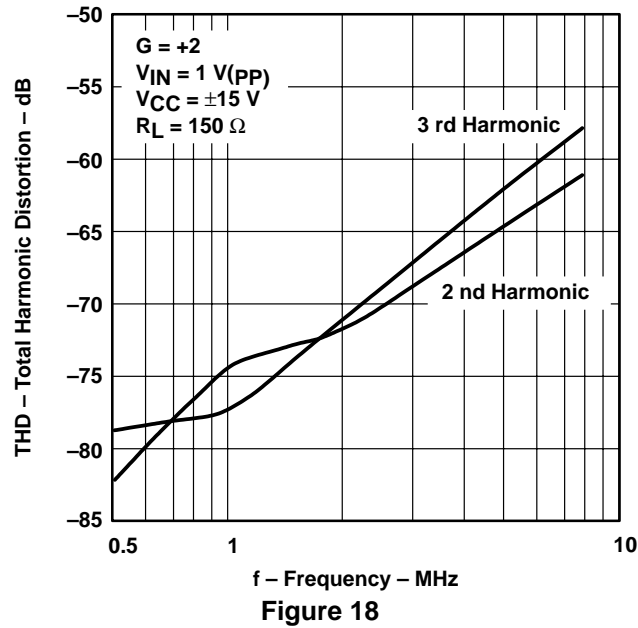

APPLICATION INFORMATION

theory of operation

The THS4001 is a high speed, operational amplifier configured in a voltage feedback architecture. It is built using a 30-V, dielectrically isolated, complementary bipolar process with NPN and PNP transistors possessing f_T s of several GHz. This results in an exceptionally high performance amplifier that has a wide bandwidth, high slew rate, fast settling time, and low distortion. A simplified schematic is shown in Figure 19.

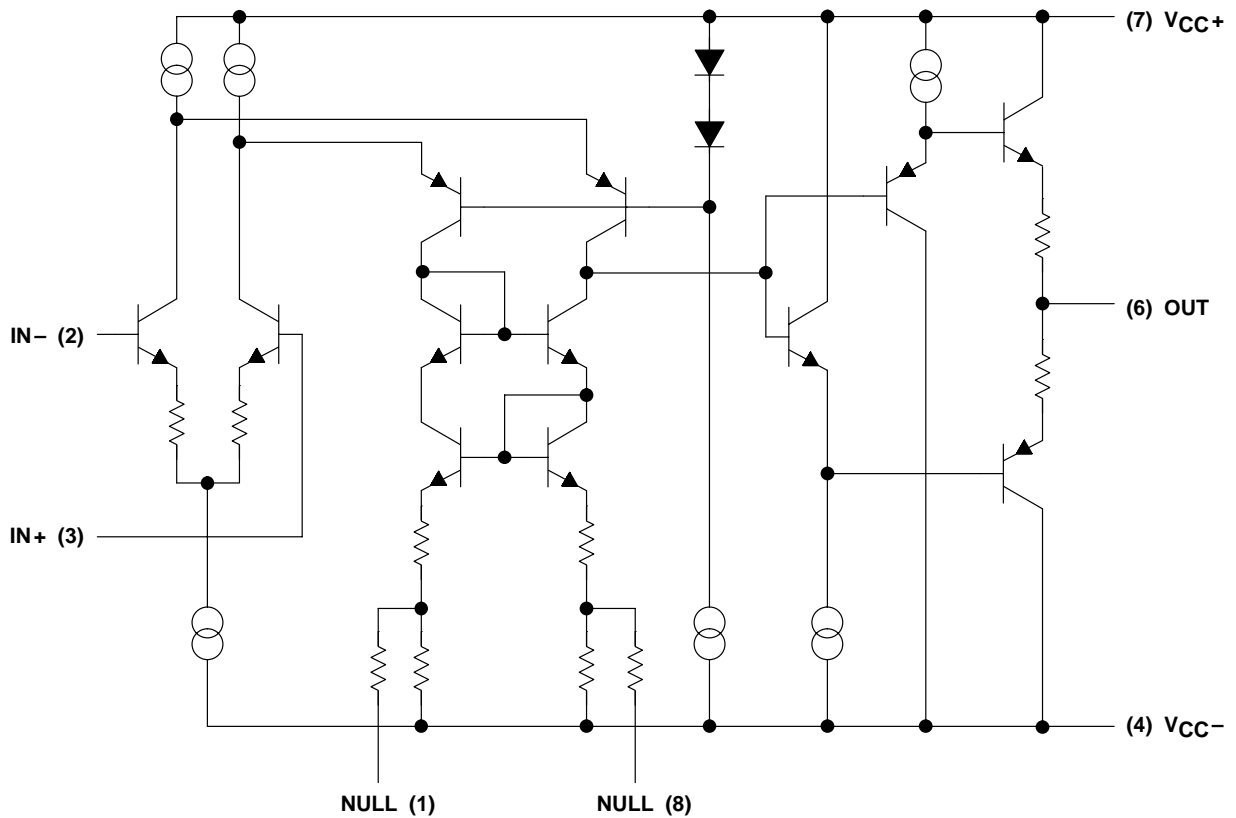

Figure 19. THS4001 Simplified Schematic

THS4001 270-MHz HIGH-SPEED AMPLIFIER

SLOS206A– DECEMBER 1997 – REVISED MARCH 1999

APPLICATION INFORMATION

offset nulling

The THS4001 has very low input offset voltage for a high-speed amplifier. However, if additional correction is required, an offset nulling function has been provided. By placing a potentiometer between terminals 1 and 8 of the device and tying the wiper to the negative supply, the input offset can be adjusted. This is shown in Figure 20.

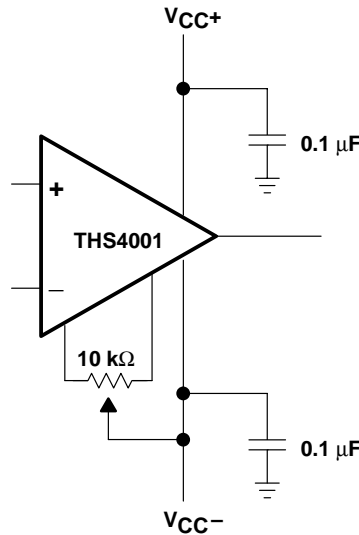

Figure 20. Offset Nulling Schematic

optimizing unity gain response

Internal frequency compensation of the THS4001 was selected to provide very wideband performance yet still maintain stability when operated in a noninverting unity gain configuration. When amplifiers are compensated in this manner there is usually peaking in the closed loop response and some ringing in the step response for very fast input edges, depending upon the application. This is because a minimum phase margin is maintained for the $G=+1$ configuration. For optimum settling time and minimum ringing, a feedback resistor of 200 Ω should be used as shown in Figure 21. Additional capacitance can also be used in parallel with the feedback resistance if even finer optimization is required.

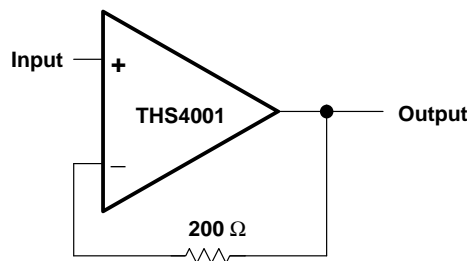

Figure 21. Noninverting, Unity Gain Schematic

APPLICATION INFORMATION

driving a capacitive load

Driving capacitive loads with high performance amplifiers is not a problem as long as certain precautions are taken. The first is to realize that the THS4001 has been internally compensated to maximize its bandwidth and slew rate performance. When the amplifier is compensated in this manner, capacitive loading directly on the output will decrease the device's phase margin leading to high frequency ringing or oscillations. Therefore, for capacitive loads of greater than 10 pF, it is recommended that a resistor be placed in series with the output of the amplifier, as shown in Figure 22. A minimum value of 20 Ω should work well for most applications. For example, in 75- Ω transmission systems, setting the series resistor value to 75 Ω both isolates any capacitance loading and provides the proper line impedance matching at the source end.

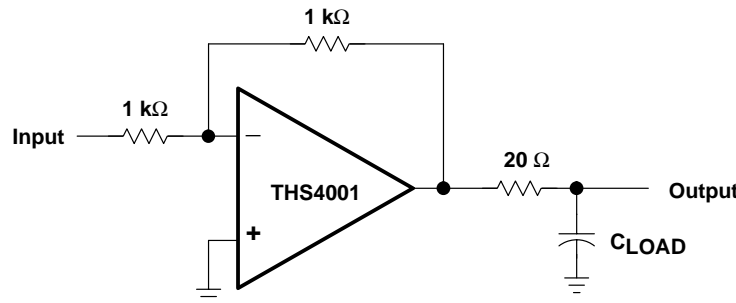

Figure 22. Driving a Capacitive Load

circuit layout considerations

In order to achieve the levels of high frequency performance of the THS4001, it is essential that proper printed-circuit board high frequency design techniques be followed. A general set of guidelines is given below. In addition, a THS4001 evaluation board is available to use as a guide for layout or for evaluating the device performance.

- Ground planes – It is highly recommended that a ground plane be used on the board to provide all components with a low inductive ground connection. However, in the areas of the amplifier inputs and output, the ground plane can be removed to minimize the stray capacitance.
- Proper power supply decoupling – Use a 6.8- μ F tantalum capacitor in parallel with a 0.1- μ F ceramic capacitor on each supply terminal. It may be possible to share the tantalum among several amplifiers depending on the application, but a 0.1- μ F ceramic capacitor should always be used on the supply terminal of every amplifier. In addition, the 0.1- μ F capacitor should be placed as close as possible to the supply terminal. As this distance increases, the inductance in the connecting trace makes the capacitor less effective. The designer should strive for distances of less than 0.1 inches between the device power terminals and the ceramic capacitors.
- Sockets – Sockets are not recommended for high speed op amps. The additional lead inductance in the socket pins will often lead to stability problems. Surface-mount packages soldered directly to the printed-circuit board is the best implementation.
- Short trace runs/compact part placements – Optimum high frequency performance is achieved when stray series inductance has been minimized. To realize this, the circuit layout should be made as compact as possible thereby minimizing the length of all trace runs. Particular attention should be paid to the inverting input of the amplifier. Its length should be kept as short as possible. This will help to minimize stray capacitance at the input of the amplifier.

THS4001 270-MHz HIGH-SPEED AMPLIFIER

SLOS206A–DECEMBER 1997 – REVISED MARCH 1999

APPLICATION INFORMATION

circuit layout considerations (continued)

- Surface-mount passive components – Using surface mount passive components is recommended for high frequency amplifier circuits for several reasons. First, because of the extremely low lead inductance of surface-mount components, the problem with stray series inductance is greatly reduced. Second, the small size of surface-mount components naturally leads to a more compact layout thereby minimizing both stray inductance and capacitance. If leaded components are used, it is recommended that the lead lengths be kept as short as possible.

evaluation board

An evaluation board is available for the THS4001 (literature number SLOP119). This board has been configured for very low parasitic capacitance in order to realize the full performance of the amplifier. A schematic of the evaluation board is shown in Figure 23. The circuitry has been designed so that the amplifier may be used in either an inverting or noninverting configuration. To order the evaluation board contact your local TI sales office or distributor. For more detailed information, refer to the *THS4001 EVM User's Manual* (literature number SLOU017).

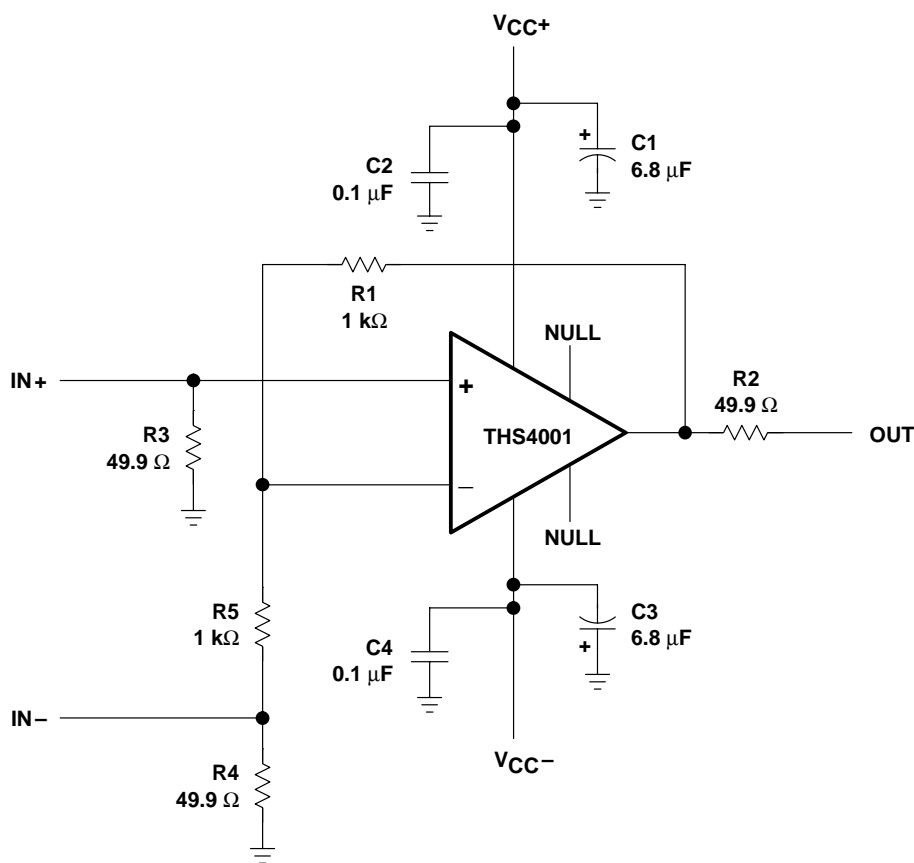

Figure 23.

PACKAGING INFORMATION

Orderable Device	Status (1)	Package Type	Package Drawing	Pins	Package Qty	Eco Plan (2)	Lead finish/ Ball material (6)	MSL Peak Temp (3)	Op Temp (°C)	Device Marking (4/5)	Samples
THS4001CD	ACTIVE	SOIC	D	8	75	RoHS & Green	NIPDAU	Level-1-260C-UNLIM		4001C	Samples
THS4001CDR	ACTIVE	SOIC	D	8	2500	RoHS & Green	NIPDAU	Level-1-260C-UNLIM	0 to 70	4001C	Samples
THS4001ID	ACTIVE	SOIC	D	8	75	RoHS & Green	NIPDAU	Level-1-260C-UNLIM		4001I	Samples
THS4001IDG4	ACTIVE	SOIC	D	8	75	RoHS & Green	NIPDAU	Level-1-260C-UNLIM	-40 to 85	4001I	Samples

(1) The marketing status values are defined as follows:

ACTIVE: Product device recommended for new designs.

LIFEBUY: TI has announced that the device will be discontinued, and a lifetime-buy period is in effect.

NRND: Not recommended for new designs. Device is in production to support existing customers, but TI does not recommend using this part in a new design.

PREVIEW: Device has been announced but is not in production. Samples may or may not be available.

OBSOLETE: TI has discontinued the production of the device.

(2) **RoHS:** TI defines "RoHS" to mean semiconductor products that are compliant with the current EU RoHS requirements for all 10 RoHS substances, including the requirement that RoHS substance do not exceed 0.1% by weight in homogeneous materials. Where designed to be soldered at high temperatures, "RoHS" products are suitable for use in specified lead-free processes. TI may reference these types of products as "Pb-Free".

RoHS Exempt: TI defines "RoHS Exempt" to mean products that contain lead but are compliant with EU RoHS pursuant to a specific EU RoHS exemption.

Green: TI defines "Green" to mean the content of Chlorine (Cl) and Bromine (Br) based flame retardants meet JS709B low halogen requirements of <=1000ppm threshold. Antimony trioxide based flame retardants must also meet the <=1000ppm threshold requirement.

(3) MSL, Peak Temp. - The Moisture Sensitivity Level rating according to the JEDEC industry standard classifications, and peak solder temperature.

(4) There may be additional marking, which relates to the logo, the lot trace code information, or the environmental category on the device.

(5) Multiple Device Markings will be inside parentheses. Only one Device Marking contained in parentheses and separated by a "-" will appear on a device. If a line is indented then it is a continuation of the previous line and the two combined represent the entire Device Marking for that device.

(6) Lead finish/Ball material - Orderable Devices may have multiple material finish options. Finish options are separated by a vertical ruled line. Lead finish/Ball material values may wrap to two lines if the finish value exceeds the maximum column width.

Important Information and Disclaimer:The information provided on this page represents TI's knowledge and belief as of the date that it is provided. TI bases its knowledge and belief on information provided by third parties, and makes no representation or warranty as to the accuracy of such information. Efforts are underway to better integrate information from third parties. TI has taken and

continues to take reasonable steps to provide representative and accurate information but may not have conducted destructive testing or chemical analysis on incoming materials and chemicals. TI and TI suppliers consider certain information to be proprietary, and thus CAS numbers and other limited information may not be available for release.

In no event shall TI's liability arising out of such information exceed the total purchase price of the TI part(s) at issue in this document sold by TI to Customer on an annual basis.

TAPE AND REEL INFORMATION



QUADRANT ASSIGNMENTS FOR PIN 1 ORIENTATION IN TAPE



*All dimensions are nominal

Device	Package Type	Package Drawing	Pins	SPQ	Reel Diameter (mm)	Reel Width W1 (mm)	A0 (mm)	B0 (mm)	K0 (mm)	P1 (mm)	W (mm)	Pin1 Quadrant
THS4001CDR	SOIC	D	8	2500	330.0	12.4	6.4	5.2	2.1	8.0	12.0	Q1

TAPE AND REEL BOX DIMENSIONS



*All dimensions are nominal

Device	Package Type	Package Drawing	Pins	SPQ	Length (mm)	Width (mm)	Height (mm)
THS4001CDR	SOIC	D	8	2500	350.0	350.0	43.0



D0008A

PACKAGE OUTLINE

SOIC - 1.75 mm max height

SMALL OUTLINE INTEGRATED CIRCUIT



4214825/C 02/2019

NOTES:

1. Linear dimensions are in inches [millimeters]. Dimensions in parenthesis are for reference only. Controlling dimensions are in inches. Dimensioning and tolerancing per ASME Y14.5M.
2. This drawing is subject to change without notice.
3. This dimension does not include mold flash, protrusions, or gate burrs. Mold flash, protrusions, or gate burrs shall not exceed .006 [0.15] per side.
4. This dimension does not include interlead flash.
5. Reference JEDEC registration MS-012, variation AA.

EXAMPLE BOARD LAYOUT

D0008A

SOIC - 1.75 mm max height

SMALL OUTLINE INTEGRATED CIRCUIT



LAND PATTERN EXAMPLE
 EXPOSED METAL SHOWN
 SCALE:8X



SOLDER MASK DETAILS

4214825/C 02/2019

NOTES: (continued)

- 6. Publication IPC-7351 may have alternate designs.
- 7. Solder mask tolerances between and around signal pads can vary based on board fabrication site.

EXAMPLE STENCIL DESIGN

D0008A

SOIC - 1.75 mm max height

SMALL OUTLINE INTEGRATED CIRCUIT



SOLDER PASTE EXAMPLE
BASED ON .005 INCH [0.125 MM] THICK STENCIL
SCALE:8X

4214825/C 02/2019

NOTES: (continued)

8. Laser cutting apertures with trapezoidal walls and rounded corners may offer better paste release. IPC-7525 may have alternate design recommendations.
9. Board assembly site may have different recommendations for stencil design.

IMPORTANT NOTICE AND DISCLAIMER

TI PROVIDES TECHNICAL AND RELIABILITY DATA (INCLUDING DATASHEETS), DESIGN RESOURCES (INCLUDING REFERENCE DESIGNS), APPLICATION OR OTHER DESIGN ADVICE, WEB TOOLS, SAFETY INFORMATION, AND OTHER RESOURCES "AS IS" AND WITH ALL FAULTS, AND DISCLAIMS ALL WARRANTIES, EXPRESS AND IMPLIED, INCLUDING WITHOUT LIMITATION ANY IMPLIED WARRANTIES OF MERCHANTABILITY, FITNESS FOR A PARTICULAR PURPOSE OR NON-INFRINGEMENT OF THIRD PARTY INTELLECTUAL PROPERTY RIGHTS.

These resources are intended for skilled developers designing with TI products. You are solely responsible for (1) selecting the appropriate TI products for your application, (2) designing, validating and testing your application, and (3) ensuring your application meets applicable standards, and any other safety, security, or other requirements. These resources are subject to change without notice. TI grants you permission to use these resources only for development of an application that uses the TI products described in the resource. Other reproduction and display of these resources is prohibited. No license is granted to any other TI intellectual property right or to any third party intellectual property right. TI disclaims responsibility for, and you will fully indemnify TI and its representatives against, any claims, damages, costs, losses, and liabilities arising out of your use of these resources.

TI's products are provided subject to TI's Terms of Sale (<https://www.ti.com/legal/termsofsale.html>) or other applicable terms available either on [ti.com](https://www.ti.com) or provided in conjunction with such TI products. TI's provision of these resources does not expand or otherwise alter TI's applicable warranties or warranty disclaimers for TI products.

Mailing Address: Texas Instruments, Post Office Box 655303, Dallas, Texas 75265
Copyright © 2021, Texas Instruments Incorporated