



World wide



Isolated

Safety
Approvals

OCP



OVP

TUHS-series

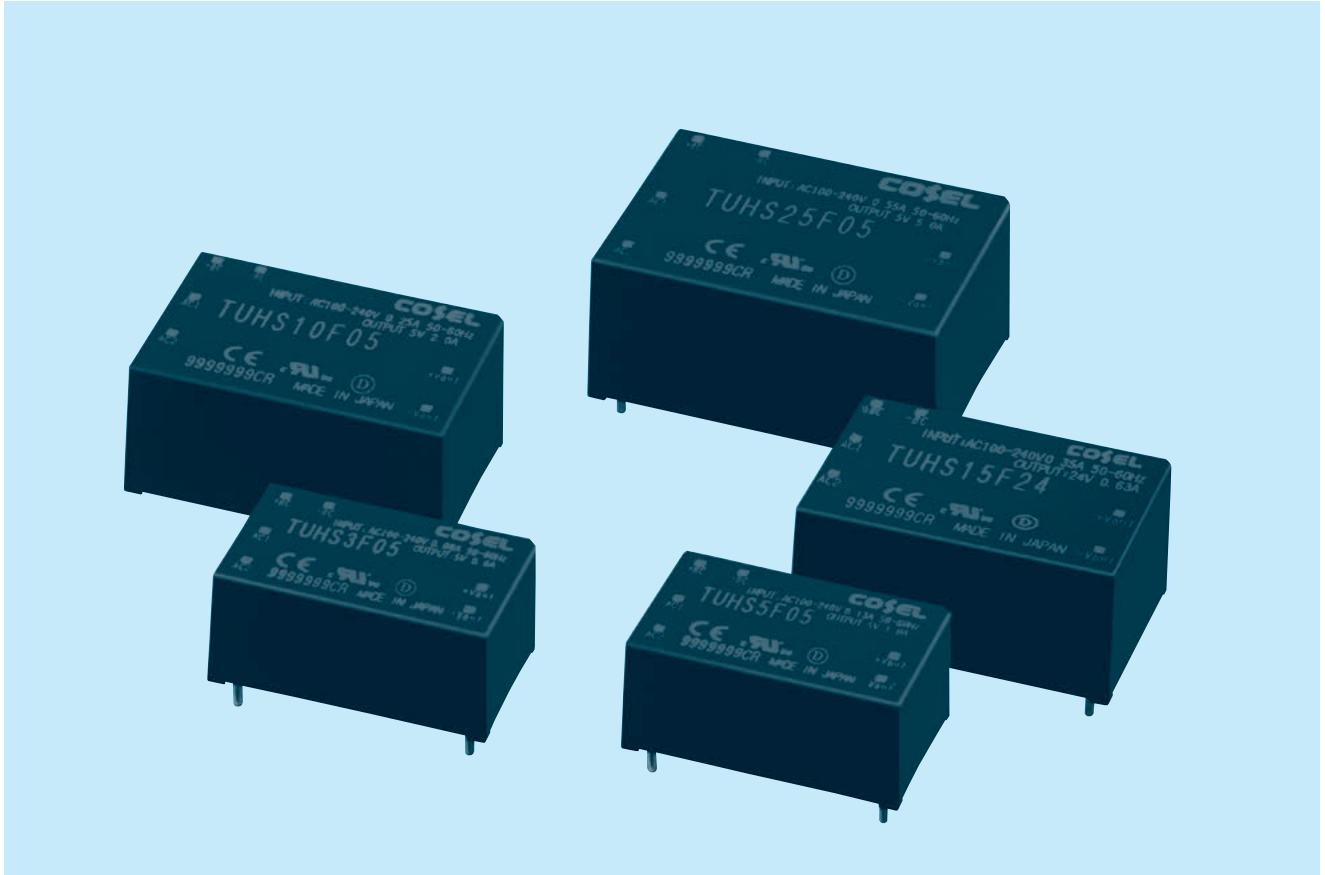

Feature

- P.C.board mount AC-DC Converter
- Design flexibility for Hold-Up time and expected life
- Small size
- Built-in overcurrent and overvoltage protection circuits
- High efficiency by synchronous rectification technology (TUHS25)
- Not built-in aluminum and tantalum electrolytic capacitor

CE marking

- Low voltage directive
- RoHS Directive

Safety Approval

- UL60950-1, C-UL, EN60950-1

5-year warranty

TUHS3

TUH S 3 F 05

① ② ③ ④ ⑤

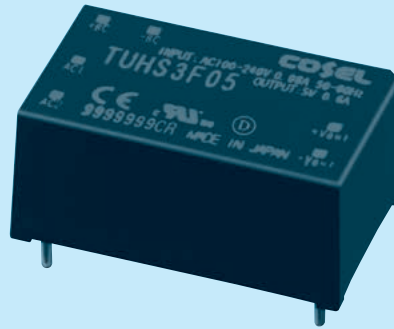

- ① Series name
- ② Single output
- ③ Output wattage
- ④ Universal Input
- ⑤ Output voltage

□ Class II

* Avoid short circuit between +BC and -BC. It may cause the failure of inside components.
 * To use TUHS, external components are required. Refer to the instruction manual for details.

MODEL	TUHS3F05	TUHS3F12	TUHS3F15	TUHS3F24
MAX OUTPUT WATTAGE[W]	3.00	3.00	3.00	3.12
DC OUTPUT	5V 0.6A	12V 0.25A	15V 0.2A	24V 0.13A

SPECIFICATIONS

	MODEL	TUHS3F05	TUHS3F12	TUHS3F15	TUHS3F24	
INPUT	VOLTAGE[V]	AC85 - 264 1 φ DC120 - 370				
	CURRENT[A]	ACIN 100V	0.08typ (Io=100%)			
		ACIN 200V	0.05typ (Io=100%)			
	FREQUENCY[Hz]	50/60 (47 - 63)				
	EFFICIENCY[%]	ACIN 100V	79typ	81typ	81typ	81typ
ACIN 200V		78typ	79typ	79typ	79typ	
INRUSH CURRENT	Limited by external components					
OUTPUT	VOLTAGE[V]	5	12	15	24	
	CURRENT[A]	0.6	0.25	0.2	0.13	
	LINE REGULATION[mV]	20max	48max	60max	96max	
	LOAD REGULATION[mV]	40max	100max	120max	150max	
	RIPPLE[mVp-p]	30 to 100% Load *1	120max	160max	160max	200max
		0 to 30% Load AC85V - 240V *1	400max	480max	480max	580max
	RIPPLE NOISE[mVp-p]	30 to 100% Load *1	160max	200max	200max	240max
		0 to 30% Load AC85V - 240V *1	480max	560max	560max	660max
	TEMPERATURE REGULATION[mV]	0 to +85°C	100max	180max	240max	360max
		-40 to +85°C	150max	270max	360max	480max
DRIFT[mV]	*2	20max	48max	60max	96max	
OUTPUT VOLTAGE SETTING[V]	4.90 - 5.30	11.40 - 12.60	14.25 - 15.75	23.00 - 25.00		
PROTECTION CIRCUIT AND OTHERS	OVERCURRENT PROTECTION	Works over 105% of rating and recover automatically				
	OVERVOLTAGE PROTECTION[V]	5.50 - 8.00	13.20 - 19.20	16.50 - 24.00	26.40 - 38.40	
ISOLATION	INPUT-OUTPUT	AC3,000V 1minute, Cutoff current = 10mA, DC500V 50MΩ min (20±15°C)				
ENVIRONMENT	OPERATING TEMP., HUMID. AND ALTITUDE	-40 to +85°C, 20 - 95%RH (Non condensing) (Refer to "Derating"), 3,000m (10,000 feet) max				
	STORAGE TEMP., HUMID. AND ALTITUDE	-40 to +100°C, 20 - 95%RH (Non condensing), 9,000m (30,000 feet) max				
	VIBRATION	10 - 55Hz, 49.0m/s ² (5G), 3minutes period, 60minutes each along X, Y and Z axis				
	IMPACT	196.1m/s ² (20G), 11ms, once each along X, Y and Z axis				
SAFETY AND NOISE REGULATIONS	AGENCY APPROVALS	UL60950-1, C-UL (CSA60950-1), EN60950-1				
	CONDUCTED NOISE	Complies with FCC-B, VCCI-B, CISPR-B, EN55022-B *3				
	HARMONIC ATTENUATOR	Complies with IEC61000-3-2 (Class A) (Not built-in to active filter)				
OTHERS	CASE SIZE/WEIGHT	28.7 X 12.7 X 17.5mm[1.13 X 0.50 X 0.69 inches] (W X H X D) / 15g max				
	COOLING METHOD	Convection / Forced air				

*1 Refer to instruction manual for measuring method of electric characteristics.
 *2 Drift is the change in DC output for an eight hour period after a half-hour warm-up at 25°C, with the input voltage held constant at the rated value.
 *3 Do not ground secondly circuit, in case of a standard adapted.
 * Measured with 18μF capacitor as Cbc.

External view

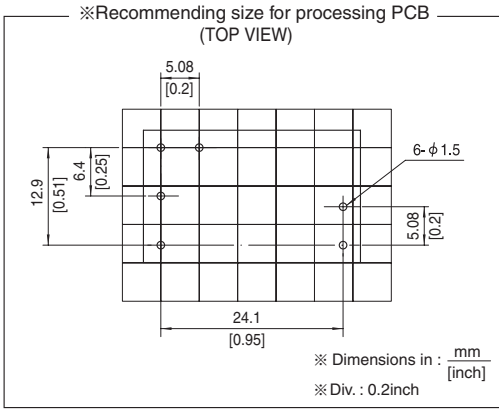
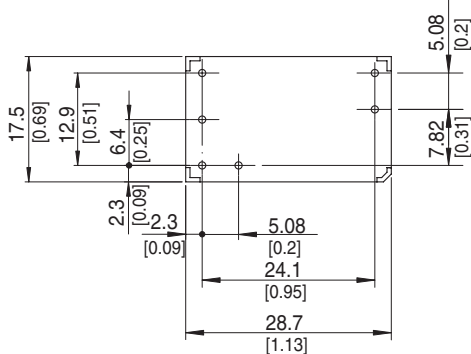
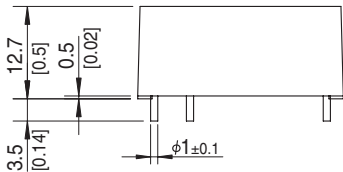
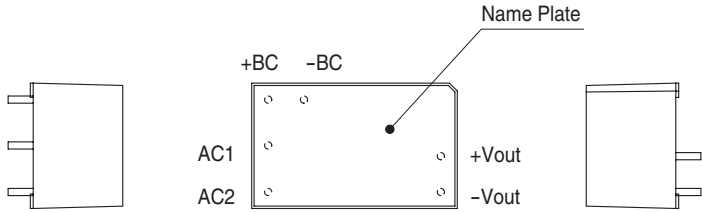

- ※ Tolerance : ± 0.5 [± 0.02]
- ※ Weight : 15g max
- ※ Case material : PBT
- ※ Pin material : Copper
- ※ Plating treatment of pin : Lead free plating
- ※ Dimensions in mm, []=inches

TUHS5

TUH S 5 F 05

① ② ③ ④ ⑤

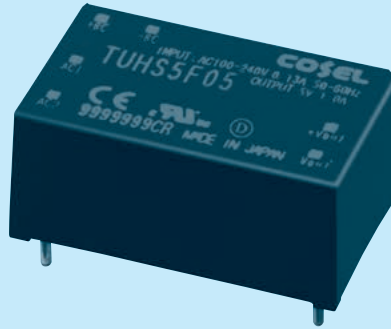

- ① Series name
- ② Single output
- ③ Output wattage
- ④ Universal Input
- ⑤ Output voltage

□ Class II

* Avoid short circuit between +BC and -BC. It may cause the failure of inside components.
 * To use TUHS, external components are required. Refer to the instruction manual for details.

MODEL	TUHS5F05	TUHS5F12	TUHS5F15	TUHS5F24
MAX OUTPUT WATTAGE[W]	5.00	5.40	5.10	5.28
DC OUTPUT	5V 1A	12V 0.45A	15V 0.34A	24V 0.22A

SPECIFICATIONS

	MODEL	TUHS5F05	TUHS5F12	TUHS5F15	TUHS5F24	
INPUT	VOLTAGE[V]	AC85 - 264 1 φ DC120 - 370				
	CURRENT[A]	ACIN 100V	0.13typ (Io=100%)			
		ACIN 200V	0.08typ (Io=100%)			
	FREQUENCY[Hz]	50/60 (47 - 63)				
	EFFICIENCY[%]	ACIN 100V	78typ	82typ	82typ	83typ
		ACIN 200V	79typ	82typ	82typ	83typ
INRUSH CURRENT	Limited by external components					
OUTPUT	VOLTAGE[V]	5	12	15	24	
	CURRENT[A]	1	0.45	0.34	0.22	
	LINE REGULATION[mV]	20max	48max	60max	96max	
	LOAD REGULATION[mV]	40max	100max	120max	150max	
	RIPPLE[mVp-p]	30 to 100% Load *1	120max	160max	160max	200max
		0 to 30% Load AC85V - 240V *1	400max	480max	480max	580max
	RIPPLE NOISE[mVp-p]	30 to 100% Load *1	160max	200max	200max	240max
		0 to 30% Load AC85V - 240V *1	480max	560max	560max	660max
	TEMPERATURE REGULATION[mV]	0 to +80°C	100max	180max	240max	360max
		-40 to +80°C	150max	270max	360max	480max
DRIFT[mV]	*2	20max	48max	60max	96max	
OUTPUT VOLTAGE SETTING[V]		4.90 - 5.30	11.40 - 12.60	14.25 - 15.75	23.00 - 25.00	
PROTECTION CIRCUIT AND OTHERS	OVERCURRENT PROTECTION	Works over 105% of rating and recover automatically				
	OVERVOLTAGE PROTECTION[V]	5.50 - 8.00	13.20 - 19.20	16.50 - 24.00	26.40 - 38.40	
ISOLATION	INPUT-OUTPUT	AC3,000V 1minute, Cutoff current = 10mA, DC500V 50MΩ min (20±15°C)				
ENVIRONMENT	OPERATING TEMP., HUMID. AND ALTITUDE	-40 to +85°C, 20 - 95%RH (Non condensing) (Refer to "Derating"), 3,000m (10,000 feet) max				
	STORAGE TEMP., HUMID. AND ALTITUDE	-40 to +100°C, 20 - 95%RH (Non condensing), 9,000m (30,000 feet) max				
	VIBRATION	10 - 55Hz, 49.0m/s ² (5G), 3minutes period, 60minutes each along X, Y and Z axis				
	IMPACT	196.1m/s ² (20G), 11ms, once each along X, Y and Z axis				
SAFETY AND NOISE REGULATIONS	AGENCY APPROVALS	UL60950-1, C-UL (CSA60950-1), EN60950-1				
	CONDUCTED NOISE	Complies with FCC-B, VCCI-B, CISPR-B, EN55022-B *3				
	HARMONIC ATTENUATOR	Complies with IEC61000-3-2 (Class A) (Not built-in to active filter)				
OTHERS	CASE SIZE/WEIGHT	28.7 X 12.7 X 17.5mm[1.13 X 0.50 X 0.69 inches] (W X H X D) / 15g max				
	COOLING METHOD	Convection / Forced air				

*1 Refer to instruction manual for measuring method of electric characteristics.
 *2 Drift is the change in DC output for an eight hour period after a half-hour warm-up at 25°C, with the input voltage held constant at the rated value.
 *3 Do not ground secondly circuit, in case of a standard adapted.
 * Measured with 22μF capacitor as Cbc.

External view

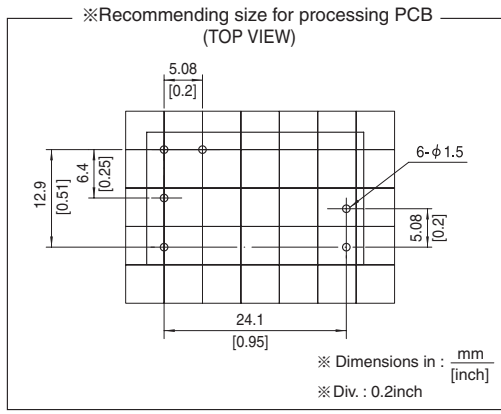
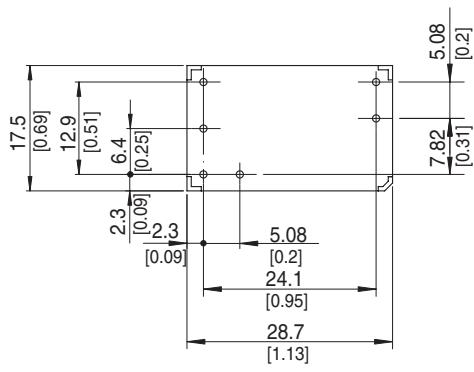
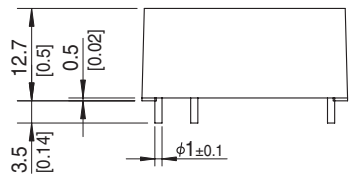
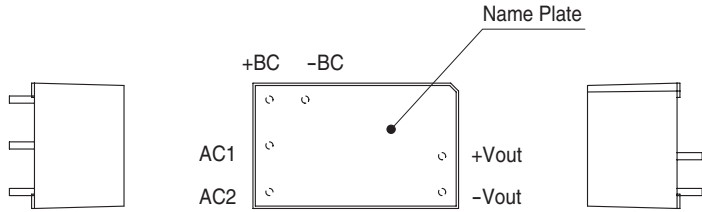

- ※ Tolerance : ± 0.5 [± 0.02]
- ※ Weight : 15g max
- ※ Case material : PBT
- ※ Pin material : Copper
- ※ Plating treatment of pin : Lead free plating
- ※ Dimensions in mm, []=inches

TUHS10

TUH S 10 F 05

① ② ③ ④ ⑤

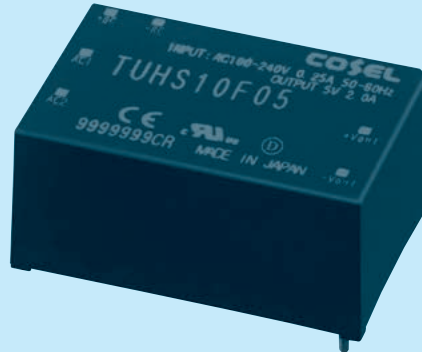

- ① Series name
- ② Single output
- ③ Output wattage
- ④ Universal Input
- ⑤ Output voltage

□ Class II

* Avoid short circuit between +BC and -BC. It may cause the failure of inside components.
 * To use TUHS, external components are required. Refer to the instruction manual for details.

MODEL	TUHS10F05	TUHS10F12	TUHS10F15	TUHS10F24
MAX OUTPUT WATTAGE[W]	10.00	10.80	10.10	10.80
DC OUTPUT	5V 2A	12V 0.9A	15V 0.67A	24V 0.45A

SPECIFICATIONS

	MODEL	TUHS10F05	TUHS10F12	TUHS10F15	TUHS10F24	
INPUT	VOLTAGE[V]	AC85 - 264 1 φ DC120 - 370				
	CURRENT[A]	ACIN 100V	0.25typ (Io=100%)			
		ACIN 200V	0.14typ (Io=100%)			
	FREQUENCY[Hz]	50/60 (47 - 63)				
	EFFICIENCY[%]	ACIN 100V	81typ	85typ	85typ	86typ
		ACIN 200V	82typ	85typ	85typ	87typ
INRUSH CURRENT	Limited by external components					
OUTPUT	VOLTAGE[V]	5	12	15	24	
	CURRENT[A]	2	0.9	0.67	0.45	
	LINE REGULATION[mV]	20max	48max	60max	96max	
	LOAD REGULATION[mV]	40max	100max	120max	150max	
	RIPPLE[mVp-p]	30 to 100% Load *1	120max	160max	160max	200max
		0 to 30% Load AC85V - 240V *1	400max	480max	480max	580max
	RIPPLE NOISE[mVp-p]	30 to 100% Load *1	160max	200max	200max	240max
		0 to 30% Load AC85V - 240V *1	480max	560max	560max	660max
	TEMPERATURE REGULATION[mV]	0 to +70°C	100max	180max	240max	360max
		-40 to +70°C	150max	270max	360max	480max
DRIFT[mV]	*2	20max	48max	60max	96max	
OUTPUT VOLTAGE SETTING[V]		4.90 - 5.30	11.40 - 12.60	14.25 - 15.75	23.00 - 25.00	
PROTECTION CIRCUIT AND OTHERS	OVERCURRENT PROTECTION	Works over 105% of rating and recover automatically				
	OVERVOLTAGE PROTECTION[V]	5.50 - 8.00	13.20 - 19.20	16.50 - 24.00	26.40 - 38.40	
ISOLATION	INPUT-OUTPUT	AC3,000V 1minute, Cutoff current = 10mA, DC500V 50MΩ min (20±15°C)				
ENVIRONMENT	OPERATING TEMP., HUMID. AND ALTITUDE	-40 to +85°C, 20 - 95%RH (Non condensing) (Refer to "Derating"), 3,000m (10,000 feet) max				
	STORAGE TEMP., HUMID. AND ALTITUDE	-40 to +100°C, 20 - 95%RH (Non condensing), 9,000m (30,000 feet) max				
	VIBRATION	10 - 55Hz, 49.0m/s ² (5G), 3minutes period, 60minutes each along X, Y and Z axis				
	IMPACT	196.1m/s ² (20G), 11ms, once each along X, Y and Z axis				
SAFETY AND NOISE REGULATIONS	AGENCY APPROVALS	UL60950-1, C-UL (CSA60950-1), EN60950-1				
	CONDUCTED NOISE	Complies with FCC-B, VCCI-B, CISPR-B, EN55022-B *3				
	HARMONIC ATTENUATOR	Complies with IEC61000-3-2 (Class A) (Not built-in to active filter)				
OTHERS	CASE SIZE/WEIGHT	33.0 X 15.0 X 22.0mm [1.3 X 0.59 X 0.86 inches] (W X H X D) / 25g max				
	COOLING METHOD	Convection / Forced air				

*1 Refer to instruction manual for measuring method of electric characteristics.
 *2 Drift is the change in DC output for an eight hour period after a half-hour warm-up at 25°C, with the input voltage held constant at the rated value.
 *3 Do not ground secondly circuit, in case of a standard adapted.
 * Measured with 47μF capacitor as Cbc.

External view

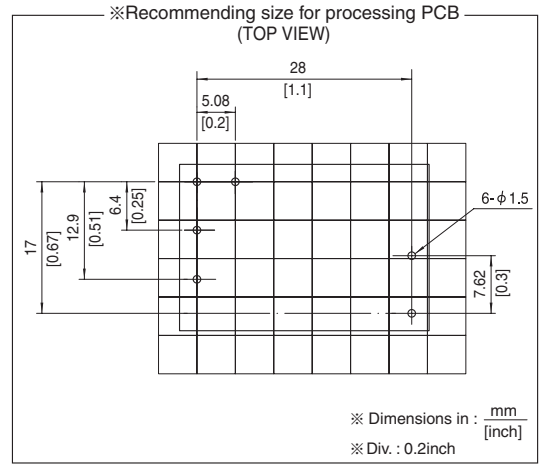
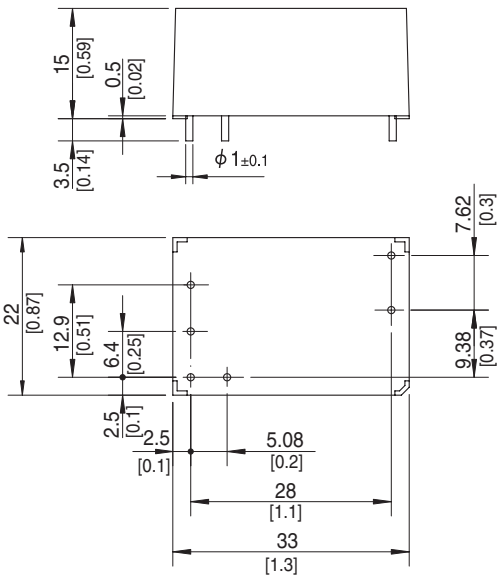
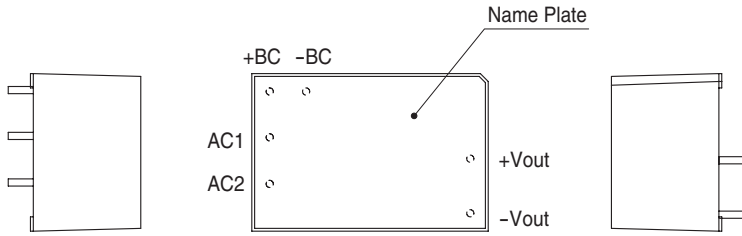

- ※ Tolerance : ± 0.5 [± 0.02]
- ※ Weight : 25g max
- ※ Case material : PBT
- ※ Pin material : Copper
- ※ Plating treatment of pin : Lead free plating
- ※ Dimensions in mm, []=inches

TUHS15

TUH S 15 F 12

① ② ③ ④ ⑤

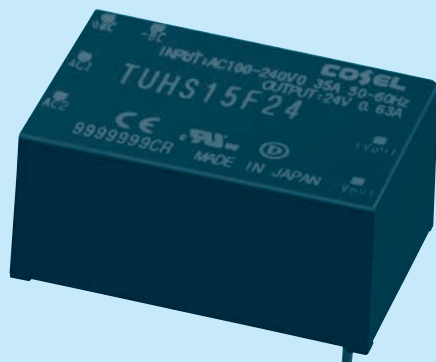

- ① Series name
- ② Single output
- ③ Output wattage
- ④ Universal Input
- ⑤ Output voltage

□ Class II

* Avoid short circuit between +BC and -BC. It may cause the failure of inside components.
 * To use TUHS, external components are required. Refer to the instruction manual for details.

MODEL	TUHS15F12	TUHS15F15	TUHS15F24
MAX OUTPUT WATTAGE[W]	15.00	15.00	15.12
DC OUTPUT	12V 1.25A	15V 1A	24V 0.63A

SPECIFICATIONS

	MODEL	TUHS15F12	TUHS15F15	TUHS15F24	
INPUT	VOLTAGE[V]	AC85 - 264 1 φ DC120 - 370			
	CURRENT[A]	ACIN 100V	0.35typ (Io=100%)		
		ACIN 200V	0.18typ (Io=100%)		
	FREQUENCY[Hz]	50/60 (47 - 63)			
	EFFICIENCY[%]	ACIN 100V	85typ	85typ	86typ
		ACIN 200V	85typ	85typ	87typ
INRUSH CURRENT	Limited by external components				
OUTPUT	VOLTAGE[V]	12	15	24	
	CURRENT[A]	1.25	1	0.63	
	LINE REGULATION[mV]	48max	60max	96max	
	LOAD REGULATION[mV]	100max	120max	150max	
	RIPPLE[mVp-p]	30 to 100% Load *1	160max	160max	200max
		0 to 30% Load AC85V - 240V *1	480max	480max	580max
	RIPPLE NOISE[mVp-p]	30 to 100% Load *1	200max	200max	240max
		0 to 30% Load AC85V - 240V *1	560max	560max	660max
	TEMPERATURE REGULATION[mV]	0 to +50°C	180max	240max	360max
		-40 to +50°C	270max	360max	480max
DRIFT[mV]	*2	48max	60max	96max	
OUTPUT VOLTAGE SETTING[V]	11.40 - 12.60	14.25 - 15.75	23.00 - 25.00		
PROTECTION CIRCUIT AND OTHERS	OVERCURRENT PROTECTION	Works over 105% of rating and recover automatically			
	OVERVOLTAGE PROTECTION[V]	13.20 - 19.20	16.50 - 24.00	26.40 - 38.40	
ISOLATION	INPUT-OUTPUT	AC3,000V 1minute, Cutoff current = 10mA, DC500V 50MΩ min (20±15°C)			
ENVIRONMENT	OPERATING TEMP., HUMID. AND ALTITUDE	-40 to +85°C, 20 - 95%RH (Non condensing) (Refer to "Derating"), 3,000m (10,000 feet) max			
	STORAGE TEMP., HUMID. AND ALTITUDE	-40 to +100°C, 20 - 95%RH (Non condensing), 9,000m (30,000 feet) max			
	VIBRATION	10 - 55Hz, 49.0m/s ² (5G), 3minutes period, 60minutes each along X, Y and Z axis			
	IMPACT	196.1m/s ² (20G), 11ms, once each along X, Y and Z axis			
SAFETY AND NOISE REGULATIONS	AGENCY APPROVALS	UL60950-1, C-UL (CSA60950-1), EN60950-1			
	CONDUCTED NOISE	Complies with FCC-B, VCCI-B, CISPR-B, EN55022-B *3			
	HARMONIC ATTENUATOR	Complies with IEC61000-3-2 (Class A) (Not built-in to active filter)			
OTHERS	CASE SIZE/WEIGHT	33.0 X 15.0 X 22.0mm [1.3 X 0.59 X 0.86 inches] (W X H X D) / 25g max			
	COOLING METHOD	Convection / Forced air			

*1 Refer to instruction manual for measuring method of electric characteristics.
 *2 Drift is the change in DC output for an eight hour period after a half-hour warm-up at 25°C, with the input voltage held constant at the rated value.
 *3 Do not ground secondly circuit, in case of a standard adapted.
 * Measured with 68μF capacitor as Cbc.

External view

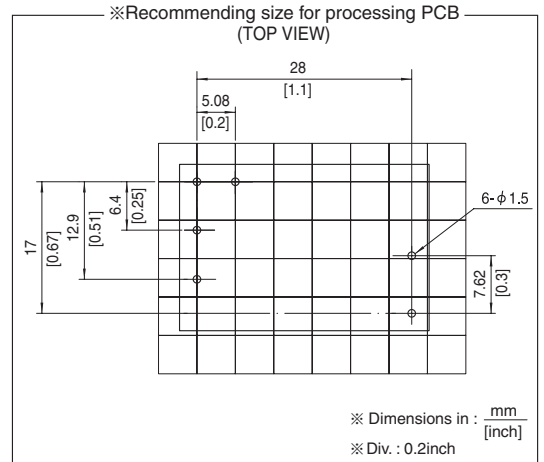
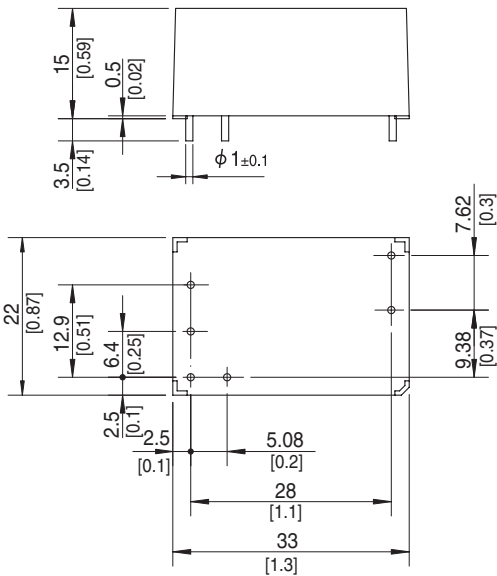
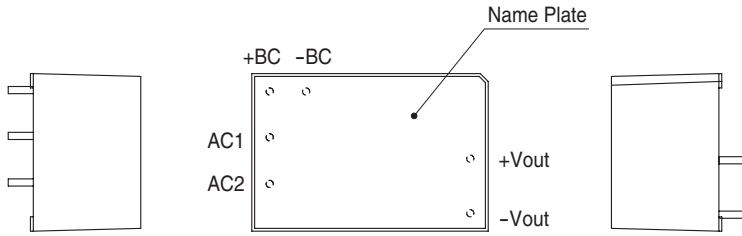

- ※ Tolerance : ± 0.5 [± 0.02]
- ※ Weight : 25g max
- ※ Case material : PBT
- ※ Pin material : Copper
- ※ Plating treatment of pin : Lead free plating
- ※ Dimensions in mm, []=inches

TUHS25

TUH S 25 F 05

① ② ③ ④ ⑤

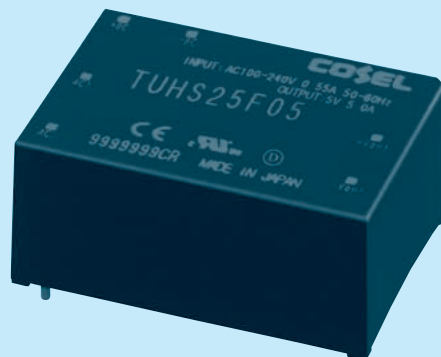

- ① Series name
- ② Single output
- ③ Output wattage
- ④ Universal Input
- ⑤ Output voltage

□ Class II

* Avoid short circuit between +BC and -BC. It may cause the failure of inside components.
 * To use TUHS, external components are required. Refer to the instruction manual for details.

MODEL	TUHS25F05	TUHS25F12	TUHS25F15	TUHS25F24
MAX OUTPUT WATTAGE[W]	25.00	25.20	25.50	26.40
DC OUTPUT	5V 5A	12V 2.1A	15V 1.7A	24V 1.1A

SPECIFICATIONS

	MODEL	TUHS25F05	TUHS25F12	TUHS25F15	TUHS25F24	
INPUT	VOLTAGE[V]	AC85 - 264 1 φ DC120 - 370				
	CURRENT[A]	ACIN 100V	0.55typ (Io=100%)			
		ACIN 200V	0.35typ (Io=100%)			
	FREQUENCY[Hz]	50/60 (47 - 63)				
	EFFICIENCY[%]	ACIN 100V	87typ	88typ	88typ	89typ
ACIN 200V		87typ	88typ	88typ	90typ	
INRUSH CURRENT		Limited by external components				
OUTPUT	VOLTAGE[V]	5	12	15	24	
	CURRENT[A]	5	2.1	1.7	1.1	
	LINE REGULATION[mV]	20max	48max	60max	96max	
	LOAD REGULATION[mV]	40max	100max	120max	150max	
	RIPPLE[mVp-p]	30 to 100% Load *1	120max	160max	160max	200max
		0 to 30% Load AC85V - 240V *1	400max	480max	480max	580max
	RIPPLE NOISE[mVp-p]	30 to 100% Load *1	160max	200max	200max	240max
		0 to 30% Load AC85V - 240V *1	480max	560max	560max	660max
	TEMPERATURE REGULATION[mV]	0 to +50°C	100max	180max	240max	360max
		-40 to +50°C	150max	270max	360max	480max
DRIFT[mV]	*2	20max	48max	60max	96max	
OUTPUT VOLTAGE SETTING[V]		4.90 - 5.30	11.40 - 12.60	14.25 - 15.75	23.00 - 25.00	
PROTECTION CIRCUIT AND OTHERS	OVERCURRENT PROTECTION	Works over 105% of rating and recover automatically				
	OVERVOLTAGE PROTECTION[V]	5.50 - 8.00	13.20 - 19.20	16.50 - 24.00	26.40 - 38.40	
ISOLATION	INPUT-OUTPUT	AC3,000V 1minute, Cutoff current = 10mA, DC500V 50MΩ min (20±15°C)				
ENVIRONMENT	OPERATING TEMP., HUMID. AND ALTITUDE	-40 to +85°C, 20 - 95%RH (Non condensing) (Refer to "Derating"), 3,000m (10,000 feet) max				
	STORAGE TEMP., HUMID. AND ALTITUDE	-40 to +100°C, 20 - 95%RH (Non condensing), 9,000m (30,000 feet) max				
	VIBRATION	10 - 55Hz, 49.0m/s ² (5G), 3minutes period, 60minutes each along X, Y and Z axis				
	IMPACT	196.1m/s ² (20G), 11ms, once each along X, Y and Z axis				
SAFETY AND NOISE REGULATIONS	AGENCY APPROVALS	UL60950-1, C-UL (CSA60950-1), EN60950-1				
	CONDUCTED NOISE	Complies with FCC-B, VCCI-B, CISPR-B, EN55022-B *3				
	HARMONIC ATTENUATOR	Complies with IEC61000-3-2 (Class A) (Not built-in to active filter)				
OTHERS	CASE SIZE/WEIGHT	36.0 X 16.5 X 25.4mm [1.42 X 0.65 X 1.0 inches] (W X H X D) / 40g max				
	COOLING METHOD	Convection / Forced air				

*1 Refer to instruction manual for measuring method of electric characteristics.
 *2 Drift is the change in DC output for an eight hour period after a half-hour warm-up at 25°C, with the input voltage held constant at the rated value.
 *3 Do not ground secondly circuit, in case of a standard adapted.
 * Measured with 120μF capacitor as Cbc.

External view

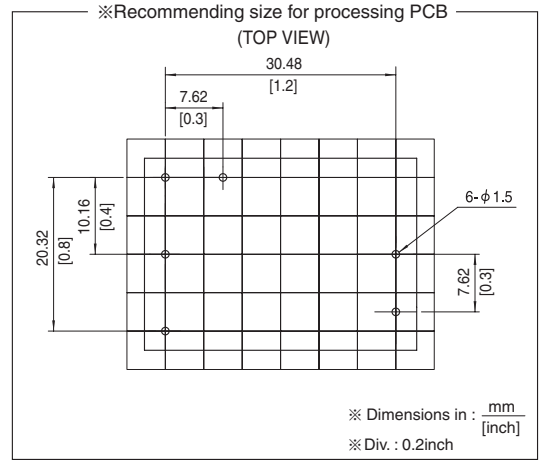
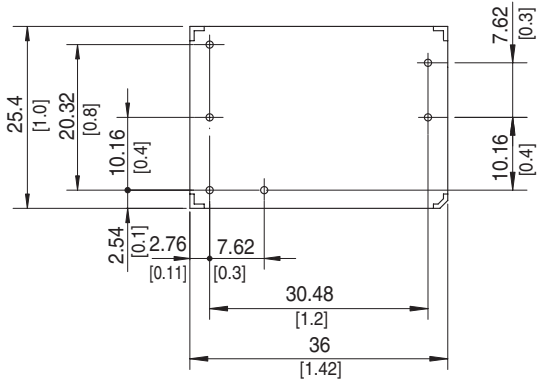
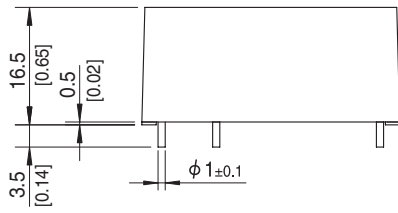
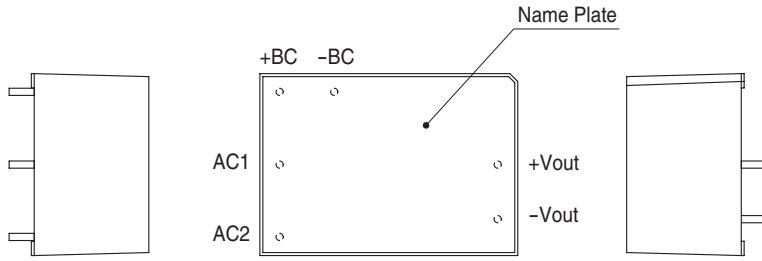

- ※ Tolerance : ± 0.5 [± 0.02]
- ※ Weight : 40g max
- ※ Case material : PBT
- ※ Pin material : Copper
- ※ Plating treatment of pin : Lead free plating
- ※ Dimensions in mm, []=inches

Pin Configuration

●TUHS3/TUHS5

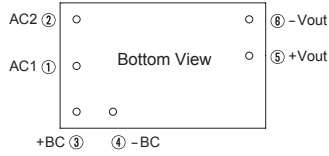

No.	Pin Connection	Function
①	AC1	AC input
②	AC2	
③	+BC	+BC output
④	-BC	-BC output
⑤	+VOUT	+DC output
⑥	-VOUT	-DC output

●TUHS10/TUHS15

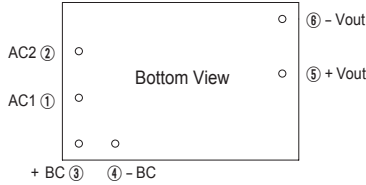

●TUHS25

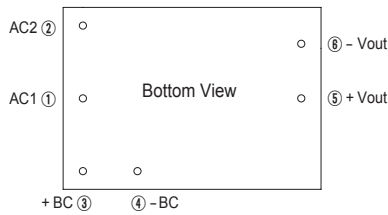

Implementation • Mounting Method

Mounting method

- The unit can be mounted in any direction. When two or more power supplies are used side by side, position them with proper intervals to allow enough air ventilation. The temperature around each power supply should not exceed the temperature range shown in derating curve.
- Avoid placing the AC input line pattern layout underneath the unit. It will increase the line conducted noise. Make sure to leave an ample distance between the line pattern layout and the unit. Also avoid placing the DC output line pattern underneath the unit because it may increase the output noise. Lay out the pattern away from the unit.
- Avoid placing the signal line pattern layout underneath the unit because the power supply might become unstable. Lay out the pattern away from the unit.

Stress to the pins

- Applying excessive stress to the input or output pins of the power module may damage internal connections. Avoid applying stress in excess of that shown in right figure.
- Input/output pin are soldered to the PCB internally. Do not pull or bend a lead powerfully.
- If it is expected that stress is applied to the input/output pin due to vibration or impact, reduce the stress to the pin by taking such measures as fixing the unit to the PCB by silicone rubber, etc.

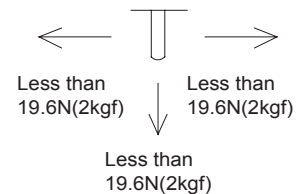

Soldering

- Flow soldering: 260°C for up to 15 seconds.
- Soldering iron (26W): 450°C for up to 5 seconds.

Derating

●Derating curve for input voltage

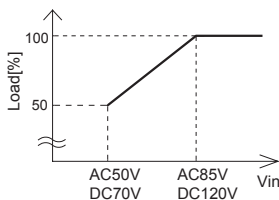

(a)TUHS3

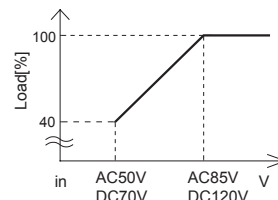

(b)TUHS5, TUHS10, TUHS15, TUHS25

Derating

● TUHS3F Ambient temperature derating curve (Reference value)

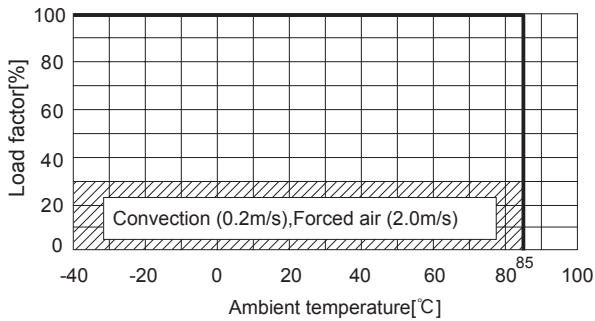

● TUHS5F Ambient temperature derating curve at convection cooling (Reference value)

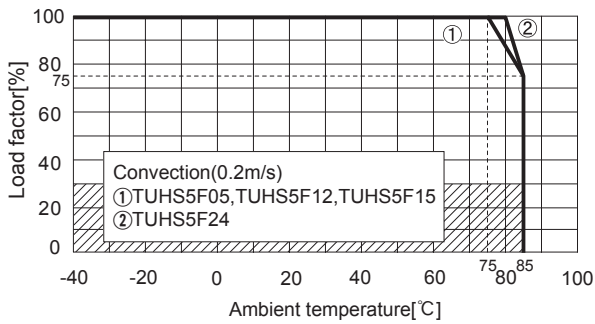

● TUHS5F Ambient temperature derating curve at forced air (Reference value)

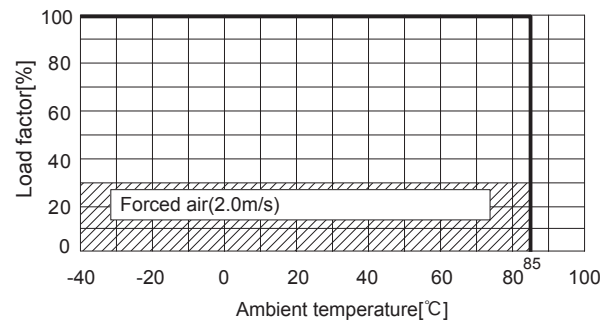

● TUHS10F Ambient temperature derating curve at convection cooling (Reference value)

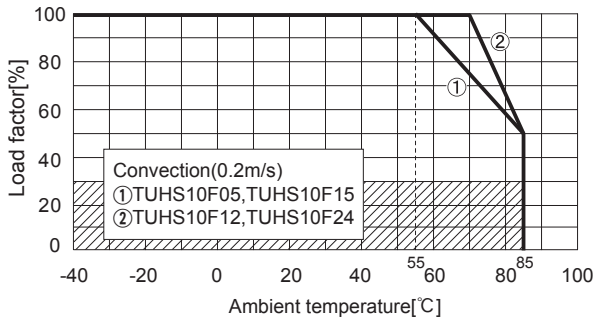

● TUHS10F Ambient temperature derating curve at forced air (Reference value)

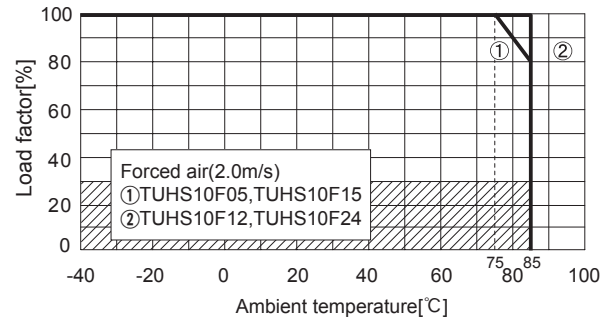

● TUHS15F Ambient temperature derating curve at convection cooling (Reference value)

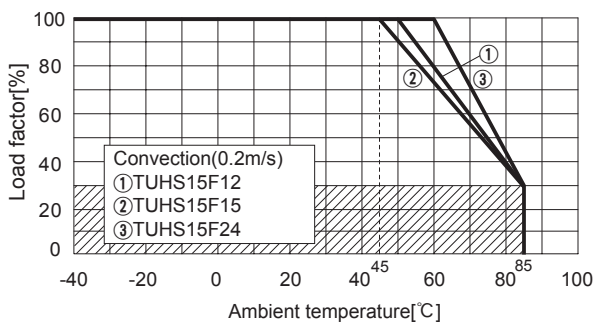

● TUHS15F Ambient temperature derating curve at forced air (Reference value)

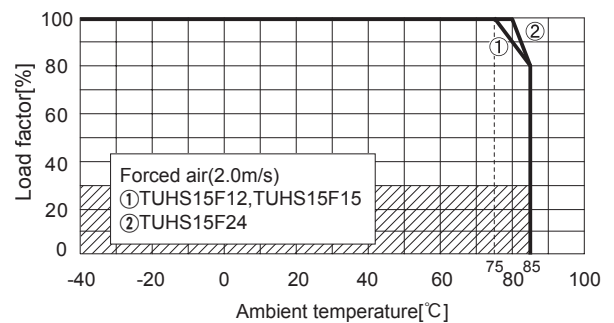

Derating

● TUHS25F Ambient temperature derating curve at convection cooling (Reference value)

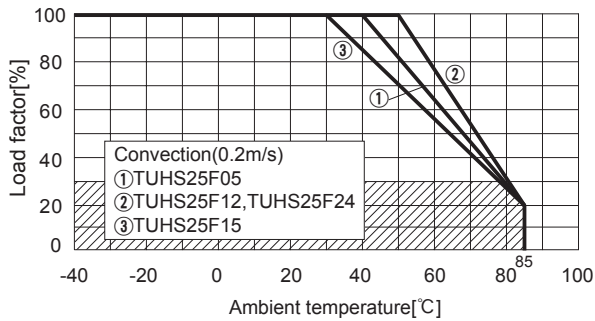

● TUHS25F Ambient temperature derating curve at forced air (Reference value)

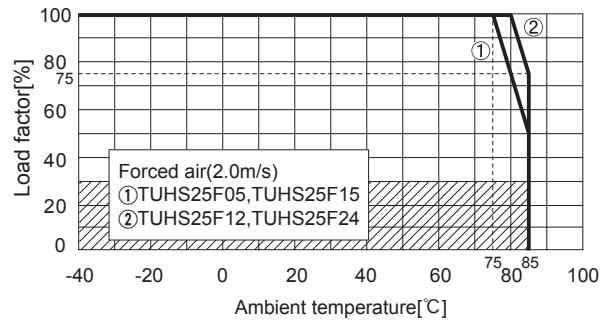

- Derating curve is shown below. Note: In the hatched area, the specification of Ripple, Ripple Noise is different from other area.
- Please have sufficient ventilation to keep the temperature of point A in Instruction Manual6. Please also make sure that the ambient temperature does not exceed 85C.

Instruction Manual

- ◆ It is necessary to read the "Instruction Manual" and "Before using our product" before you use our product.

Instruction Manual <https://en.cosel.co.jp/product/powersupply/TUHS/>
 Before using our product <https://en.cosel.co.jp/technical/caution/index.html>

TUHS



NOTICE



Basic Characteristics Data

Model	Circuit method	Switching frequency [kHz]	Input current [A]	Inrush current protection circuit	PCB/Pattern			Series/Parallel operation availability	
					Material	Single sided	Double sided	Series operation	Parallel operation
TUHS3F	Flyback converter	80-250 *3	*1	Resistor	glass fabric base,epoxy resin		Yes	Yes	*2
TUHS5F	Flyback converter	80-250 *3	*1	Resistor	glass fabric base,epoxy resin		Yes	Yes	*2
TUHS10F	Flyback converter	80-250 *3	*1	Resistor	glass fabric base,epoxy resin		Yes	Yes	*2
TUHS15F	Flyback converter	80-250 *3	*1	Resistor	glass fabric base,epoxy resin		Yes	Yes	*2
TUHS25F	Flyback converter	80-250 *3	*1	Thermistor	glass fabric base,epoxy resin		Yes	Yes	*2

*1 Refer to Specification.

*2 Refer to instruction manual.

*3 The value changes depending on input and load.

Mouser Electronics

Authorized Distributor

Click to View Pricing, Inventory, Delivery & Lifecycle Information:

Cosel:

[TUHS3F24](#) [TUHS5F24](#) [TUHS3F12](#) [TUHS25F24](#) [TUHS5F12](#) [TUHS10F24](#) [TUHS10F12](#) [TUHS10F05](#) [TUHS5F05](#)
[TUHS3F05](#) [TUHS25F12](#) [TUHS25F05](#) [TUHS15F24](#) [TUHS15F12](#)