

CDCVF25084

3.3-V 1:8 ZERO DELAY (PLL) x4 CLOCK MULTIPLIER

SCAS690A – APRIL 2003 – REVISED MAY 2003

- Phase-Locked Loop-Based Multiplier by Four
- Input Frequency Range: 2.5 MHz to 45 MHz
- Output Frequency Range: 10 MHz to 180 MHz
- LVCMOS/LVTTL I/O Compatible
- Low Jitter (Cycle-Cycle): ± 120 ps Over the Range 75 MHz to 180 MHz
- Distributes One Clock Input to Two Banks of Four Outputs
- Auto Frequency Detection to Disable Device (Power-Down Mode)
- Operates From Single 3.3-V Supply
- Industrial Temperature Range -40°C to 85°C
- 25- Ω On-Chip Series Damping Resistors
- No External RC Network Required
- Spread Spectrum Clock Compatible (SSC)
- Available in 16-Pin TSSOP Package

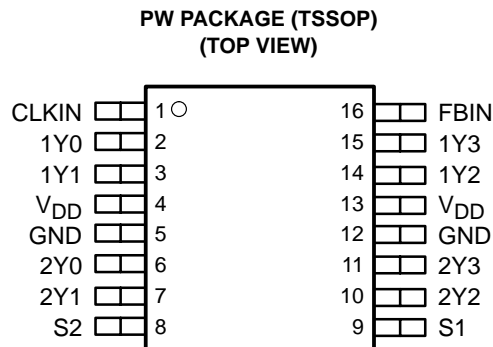

description

The CDCVF25084 is a high-performance, low-skew, low-jitter, phase-lock loop clock multiplier. It uses a PLL to precisely align, in both frequency and phase, the output clocks to the input clock signal including a multiplication factor of four. The CDCVF25084 operates from a nominal supply voltage of 3.3 V. The device also includes integrated series-damping resistors in the output drivers that make it ideal for driving point-to-point loads.

Two banks of four outputs each provide low-skew, low-jitter copies of CLKIN x four. All outputs operate at the same frequency. Output duty cycles are adjusted to 50%, independent of duty cycle at CLKIN. The device automatically goes into power-down mode when no input signal is applied to CLKIN and the outputs go into a low state. Unlike many products containing PLLs, the CDCVF25084 does not require an external RC network. The loop filter for the PLL is included on-chip, minimizing component count, space, and cost.

Because it is based on a PLL circuitry, the CDCVF25084 requires a stabilization time to achieve phase lock of the feedback signal to the reference signal. This stabilization is required following power up and application of a fixed-frequency signal at CLKIN and any following changes to the PLL reference.

The CDCVF25084 is characterized for operation from -40°C to 85°C .

FUNCTION TABLE

S2	S1	1Y0–1Y3	2Y0–2Y3	OUTPUT SOURCE	PLL SHUTDOWN
0	0	Hi-Z	Hi-Z	N/A	Yes
0	1	Active	Hi-Z	PLL [†]	No
1	0	Active	Active	Input clock (PLL bypass)	Yes
1	1	Active	Active	PLL [†]	No

[†] A CLK input frequency < 2 MHz switches the outputs to low level.



Please be aware that an important notice concerning availability, standard warranty, and use in critical applications of Texas Instruments semiconductor products and disclaimers thereto appears at the end of this data sheet.

PRODUCTION DATA information is current as of publication date. Products conform to specifications per the terms of Texas Instruments standard warranty. Production processing does not necessarily include testing of all parameters.

**TEXAS
INSTRUMENTS**

POST OFFICE BOX 655303 • DALLAS, TEXAS 75265

Copyright © 2003, Texas Instruments Incorporated

CDCVF25084

3.3-V 1:8 ZERO DELAY (PLL) x4 CLOCK MULTIPLIER

SCAS690A – APRIL 2003 – REVISED MAY 2003

Terminal Functions

TERMINAL NAME	PIN NO.	TYPE	DESCRIPTION
1Y[0:3]	2, 3, 14, 15	O	Bank 1Yn clock outputs. These outputs are low-skew copies of CLKIN. Each output has an integrated 25-Ω series-damping resistor.
2Y[0:3]	6, 7, 10, 11	O	Bank 2Yn clock outputs. These outputs are low-skew copies of CLKIN. Each output has an integrated 25-Ω series-damping resistor.
CLKIN	1	I	Clock input. CLKIN provides the clock signal to be distributed by the CDCVF25084 clock driver. CLKIN is used to provide the reference signal to the integrated PLL that generates the output signal. CLKIN must have a fixed frequency and phase in order for the PLL to acquire lock. Once the circuit is powered up and a valid signal is applied, a stabilization time is required for the PLL to phase lock the feedback signal to CLKIN.
FBIN	16	I	Feedback input. FBIN provides the feedback signal to the internal PLL. FBIN must be wired to one of the outputs to complete the feedback loop of the internal PLL. The integrated PLL synchronizes the FBIN and output signal so there is nominally zero-delay from input clock to output clock.
GND	5, 12	Ground	Ground
S1, S2	9, 8	I	Select pins to determine mode of operation. See the <i>FUNCTION TABLE</i> for mode selection options.
V _{DD}	4, 13	Power	Supply voltage. The supply voltage range is 3 V to 3.6 V



POST OFFICE BOX 655303 • DALLAS, TEXAS 75265

CDCVF25084 3.3-V 1:8 ZERO DELAY (PLL) x4 CLOCK MULTIPLIER

SCAS690A – APRIL 2003 – REVISED MAY 2003

functional block diagram

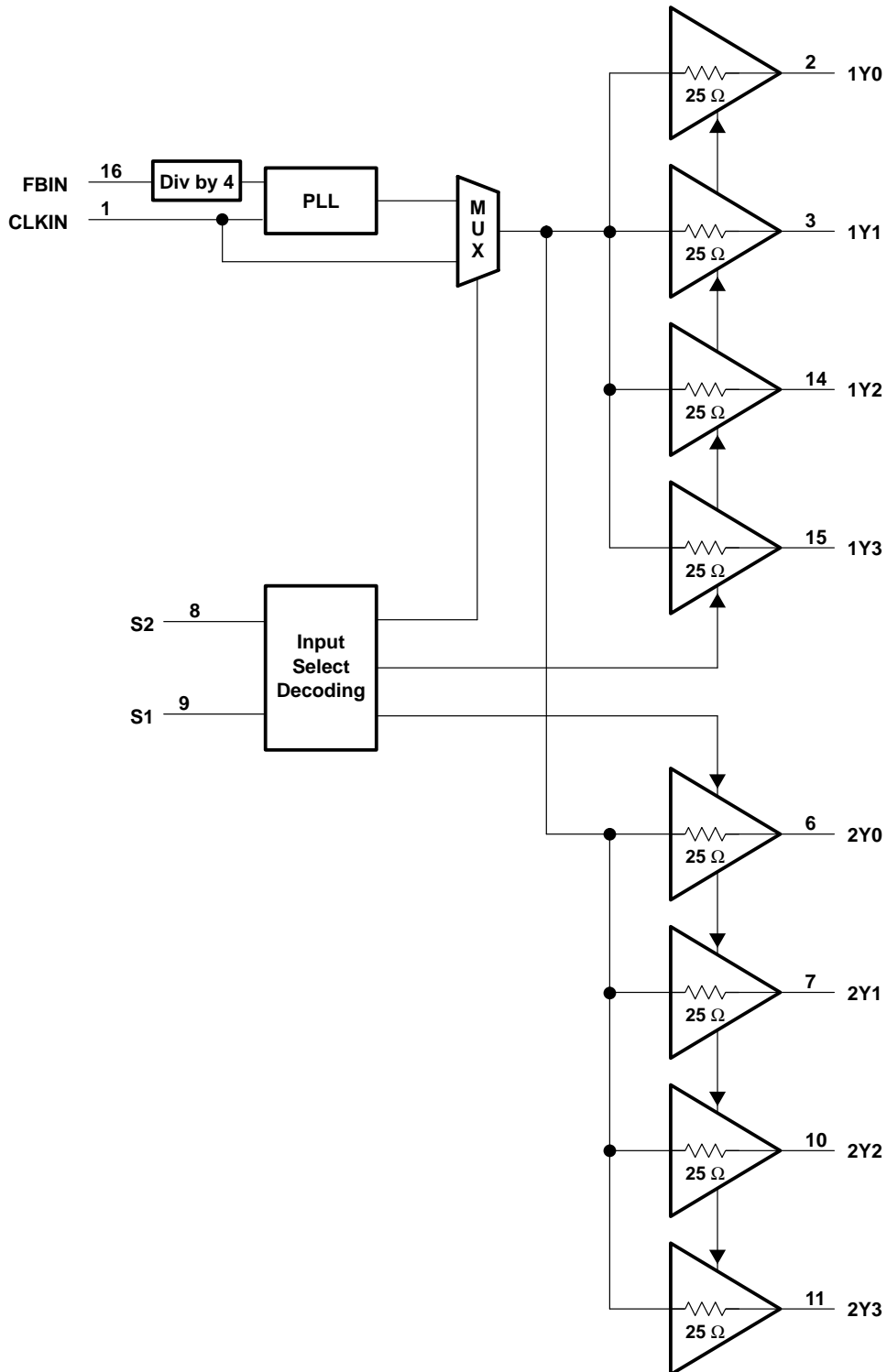

CDCVF25084

3.3-V 1:8 ZERO DELAY (PLL) x4 CLOCK MULTIPLIER

SCAS690A – APRIL 2003 – REVISED MAY 2003

absolute maximum ratings over operating free-air temperature (unless otherwise noted)†

Supply voltage range, V_{DD}	-0.5 V to 4.6 V
Input voltage range, V_I (see Notes 1 and 2)	-0.5 V to 4.6 V
Output voltage range, V_O (see Notes 1 and 2)	-0.5 V to $V_{DD} + 0.5$ V
Input clamp current, I_{IK} ($V_I < 0$)	-50 mA
Output clamp current, I_{OK} ($V_O < 0$)	-50 mA
Continuous total output current, I_O ($V_O = 0$ to V_{DD})	± 50 mA
Package thermal impedance, θ_{JA} (see Note 3): PW package	147°C/W
Storage temperature range, T_{stg}	-65°C to 150°C

† Stresses beyond those listed under “absolute maximum ratings” may cause permanent damage to the device. These are stress ratings only, and functional operation of the device at these or any other conditions beyond those indicated under “recommended operating conditions” is not implied. Exposure to absolute-maximum-rated conditions for extended periods may affect device reliability.

- NOTES:
1. The input and output negative voltage ratings may be exceeded if the input and output clamp-current ratings are observed.
 2. This value is limited to 4.6 V maximum.
 3. The package thermal impedance is calculated in accordance with JESD 51.

recommended operating conditions

	MIN	NOM	MAX	UNIT
Supply voltage, V_{DD}	3	3.3	3.6	V
Low level input voltage, V_{IL}			0.8	V
High level input voltage, V_{IH}	2			V
Input voltage, V_I	0		3.6	V
High-level output current, I_{OH}			-12	mA
Low-level output current, I_{OL}			12	mA
Operating free-air temperature, T_A	-40		85	°C

timing requirements over recommended ranges of supply voltage, load and operating free-air temperature

	MIN	NOM	MAX	UNIT
Input clock frequency, f_{CLKIN}	2.5		45	MHz
Input clock duty cycle	40%		60%	
Clock frequency, f_{clkout} $C_L = 15$ pF	10		180	MHz



CDCVF25084

3.3-V 1:8 ZERO DELAY (PLL) x4 CLOCK MULTIPLIER

SCAS690A – APRIL 2003 – REVISED MAY 2003

electrical characteristics over recommended operating free-air temperature range (unless otherwise noted)

PARAMETER		TEST CONDITIONS	MIN	TYP†	MAX	UNIT
V _{IK}	Input voltage	V _{DD} = 3 V, I _I = -18 mA			-1.2	V
I _I	Input current	V _I = 0 V or V _{DD}			±5	μA
I _{PD}	Power-down current	f _{CLKIN} = 0 MHz, V _{DD} = 3.3 V			100	μA
I _{DD} ‡	Dynamic current	f _{out} = 80 MHz, C _L = 15 pF		60	80	mA
I _{OZ}	Output 3-state	V _O = 0 V or V _{DD} , V _{DD} = 3.6 V			±5	μA
C _I	Input capacitance at FBIN, CLKIN	V _I = 0 V or V _{DD}		4		pF
C _I	Input capacitance at S1, S2	V _I = 0 V or V _{DD}		2.2		pF
C _O	Output capacitance	V _I = 0 V or V _{DD}		3		pF
V _{OH}	High-level output voltage	V _{DD} = min to max, I _{OH} = -100 μA	V _{DD} - 0.2			V
		V _{DD} = 3 V, I _{OH} = -12 mA	2.1			
		V _{DD} = 3 V, I _{OH} = -6 mA	2.4			
V _{OL}	Low-level output voltage	V _{DD} = min to max, I _{OL} = 100 μA			0.2	V
		V _{DD} = 3 V, I _{OL} = 12 mA			0.8	
		V _{DD} = 3 V, I _{OL} = 6 mA			0.55	
I _{OH}	High-level output current	V _{DD} = 3 V, V _O = 1 V			-24	mA
		V _{DD} = 3.3 V, V _O = 1.65 V			-30	
		V _{DD} = 3.6 V, V _O = 3.135 V			-15	
I _{OL}	Low-level output current	V _{DD} = 3 V, V _O = 1.95 V			26	mA
		V _{DD} = 3.3 V, V _O = 1.65 V			33	
		V _{DD} = 3.6 V, V _O = 0.4 V			14	

† All typical values are at respective nominal V_{DD}.

‡ All outputs are switching; for I_{DD} over frequency see Figure 9.

CDCVF25084

3.3-V 1:8 ZERO DELAY (PLL) x4 CLOCK MULTIPLIER

SCAS690A – APRIL 2003 – REVISED MAY 2003

switching characteristics over recommended operating free-air temperature range (unless otherwise noted)

PARAMETER		TEST CONDITIONS	MIN	TYP†	MAX	UNIT
t _(lock)	PLL lock time	f _{out} = 100 MHz		2		μs
t _(phoffset)	Phase offset (CLKIN to FBIN), (see Note 5)	f _{out} = 40 MHz to 75 MHz, V _{th} = V _{DD} /2		±200		ps
		f _{out} = 75 MHz to 180 MHz, V _{th} = V _{DD} /2		±100		
t _{PLH} , t _{PHL}	Propagation delay	S2 = High, S1 = Low (PLL bypass mode)	2.3		4.5	ns
t _{sk(o)}	Output skew (Y _n to Y _n) (see Note 4)	See Figure 3		75	150	ps
t _{sk(pp)}	Part-to-part skew (low-to-high transition)	PLL bypass mode			900	ps
		PLL mode, f _{out} = 40 MHz to 75 MHz			350	
		PLL mode, f _{out} = 75 MHz to 180 MHz			300	
t _{jit(cc)}	Jitter (cycle-to-cycle)	f _{out} = 40 MHz to 75 MHz			±220	ps
		f _{out} = 75 MHz to 180 MHz			±120	ps
t _{jit(per)}	Period jitter	f _{out} = 40 MHz to 75 MHz			260	ps
		f _{out} = 75 MHz to 180 MHz			140	ps
t _{jit(θ)}	Phase jitter	f _{out} = 75 MHz to 180 MHz, peak-to-peak (see Note 6)			±110	ps
		f _{out} = 75 MHz to 180 MHz, RMS (see Note 6)			26	ps
odc	Output duty cycle	f _{out} = 10 MHz to 180 MHz	45%		55%	
t _{sk(p)}	Pulse skew	S2 = High, S1 = low (PLL bypass mode)			0.3	ns
t _r , t _f	Rise / fall time rate	See Figure 4		1	3	V/ns

† All typical values are at respective nominal V_{DD}.

NOTES: 4. The t_{sk(o)} specification is only valid for equal loading of all outputs.

5. Similar waveform at CLKIN and FBIN are required. Output 1Y3 is used as a feedback to FBIN loaded with 11 pF and all other outputs have 15 pF. For phase displacement between CLKIN and Y-outputs, see Figure 5.

6. Input phase jitter < ±50 ps; output sample size is 20000 cycles.



PARAMETER MEASUREMENT INFORMATION

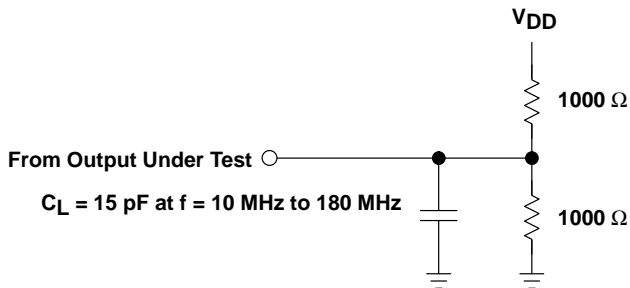

- NOTES: A. C_L includes probe and jig capacitance.
 B. All input pulses are supplied by generators having the following characteristics: $Z_O = 50 \Omega$, $t_r < 1.2 \text{ ns}$, $t_f < 1.2 \text{ ns}$
 C. The outputs are measured one at a time with one transition per measurement.

Figure 1. Test Load Circuit

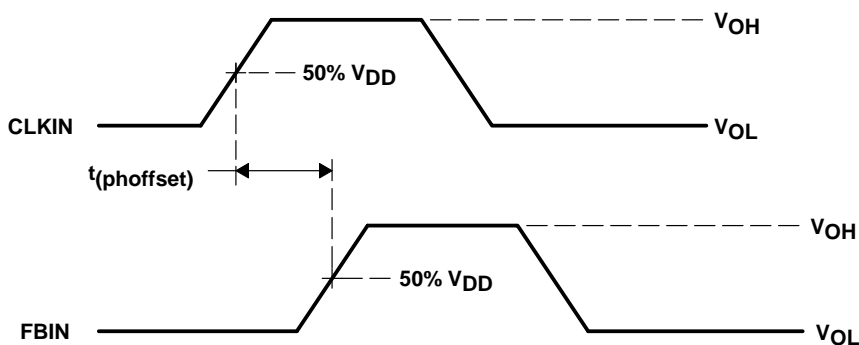
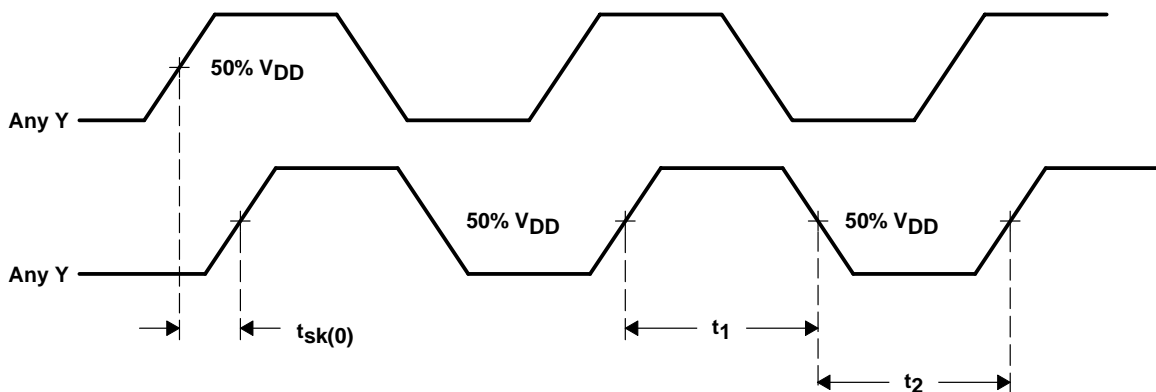

Figure 2. Voltage Thresholds for Measurements, Phase Offset (PLL Mode)



NOTE: $odc = t_1 / (t_1 + t_2) \times 100\%$

Figure 3. Output Skew and Output Duty Cycle (PLL Mode)

CDCVF25084

3.3-V 1:8 ZERO DELAY (PLL) x4 CLOCK MULTIPLIER

SCAS690A – APRIL 2003 – REVISED MAY 2003

PARAMETER MEASUREMENT INFORMATION

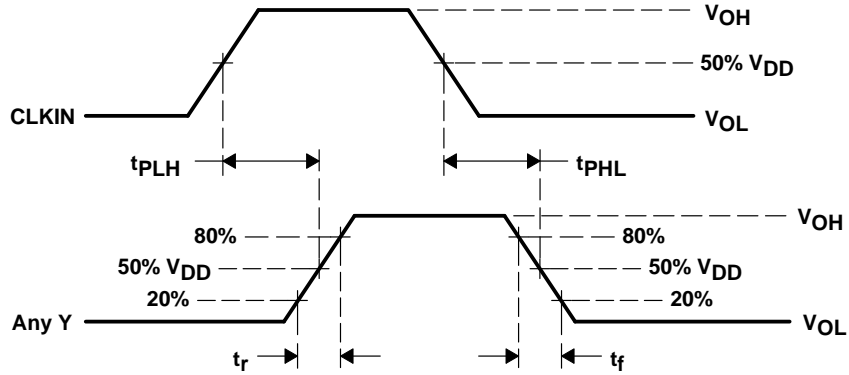

NOTE: $t_{sk(p)} = |t_{PLH} - t_{PHL}|$

Figure 4. Propagation Delay and Pulse Skew (Non-PLL Mode)

PHASE DISPLACEMENT vs CLOAD

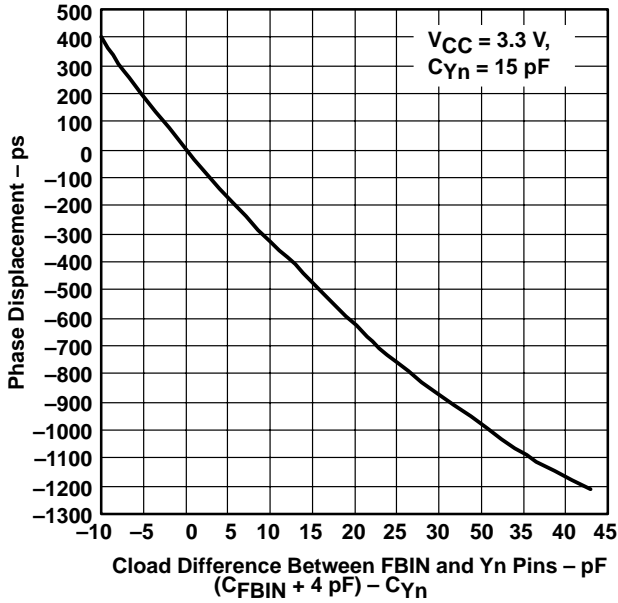

Figure 5

PHASE OFFSET vs FREQUENCY

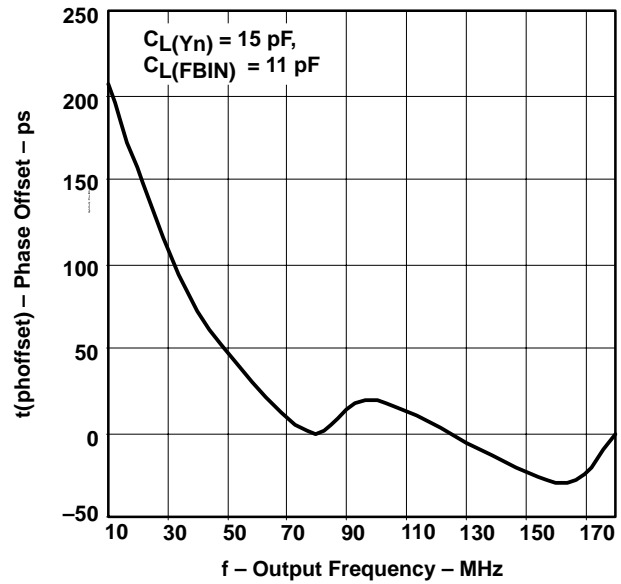

Figure 6

PARAMETER MEASUREMENT INFORMATION

CYCLE-TO-CYCLE / PERIOD JITTER
 vs
 FREQUENCY

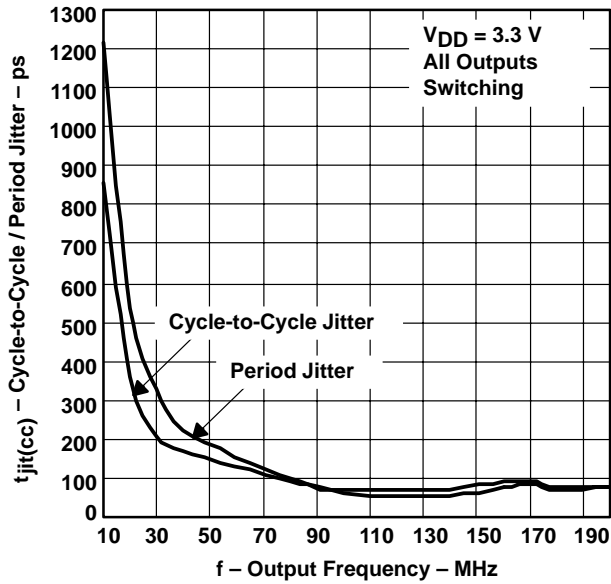

Figure 7

TRANSFER CHARACTERISTIC FROM CLKIN TO Y_n

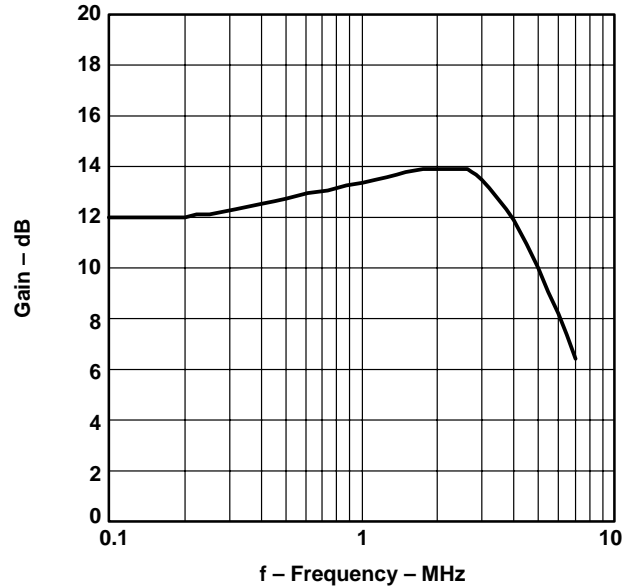

Figure 8

SUPPLY CURRENT
 vs
 FREQUENCY

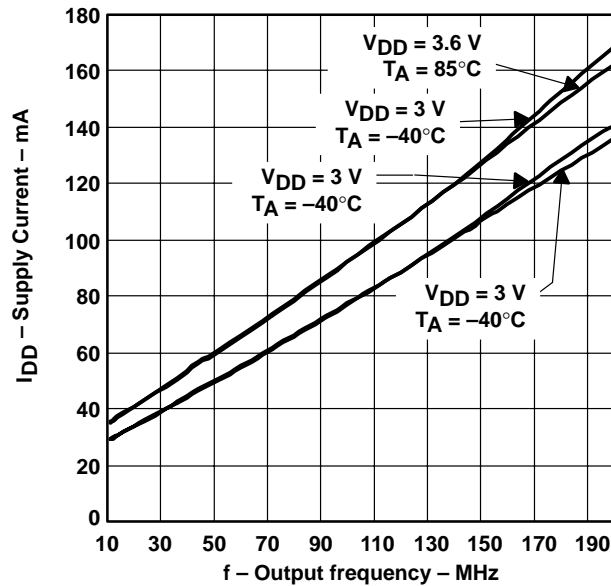

Figure 9

PACKAGING INFORMATION

Orderable Device	Status (1)	Package Type	Package Drawing	Pins	Package Qty	Eco Plan (2)	Lead finish/ Ball material (6)	MSL Peak Temp (3)	Op Temp (°C)	Device Marking (4/5)	Samples
CDCVF25084PW	ACTIVE	TSSOP	PW	16	90	RoHS & Green	NIPDAU	Level-1-260C-UNLIM	-40 to 85	CK084	Samples
CDCVF25084PWR	ACTIVE	TSSOP	PW	16	2000	RoHS & Green	NIPDAU	Level-1-260C-UNLIM	-40 to 85	CK084	Samples
CDCVF25084PWRG4	ACTIVE	TSSOP	PW	16	2000	RoHS & Green	NIPDAU	Level-1-260C-UNLIM	-40 to 85	CK084	Samples

(1) The marketing status values are defined as follows:

ACTIVE: Product device recommended for new designs.

LIFEBUY: TI has announced that the device will be discontinued, and a lifetime-buy period is in effect.

NRND: Not recommended for new designs. Device is in production to support existing customers, but TI does not recommend using this part in a new design.

PREVIEW: Device has been announced but is not in production. Samples may or may not be available.

OBSOLETE: TI has discontinued the production of the device.

(2) **RoHS:** TI defines "RoHS" to mean semiconductor products that are compliant with the current EU RoHS requirements for all 10 RoHS substances, including the requirement that RoHS substance do not exceed 0.1% by weight in homogeneous materials. Where designed to be soldered at high temperatures, "RoHS" products are suitable for use in specified lead-free processes. TI may reference these types of products as "Pb-Free".

RoHS Exempt: TI defines "RoHS Exempt" to mean products that contain lead but are compliant with EU RoHS pursuant to a specific EU RoHS exemption.

Green: TI defines "Green" to mean the content of Chlorine (Cl) and Bromine (Br) based flame retardants meet JS709B low halogen requirements of <=1000ppm threshold. Antimony trioxide based flame retardants must also meet the <=1000ppm threshold requirement.

(3) MSL, Peak Temp. - The Moisture Sensitivity Level rating according to the JEDEC industry standard classifications, and peak solder temperature.

(4) There may be additional marking, which relates to the logo, the lot trace code information, or the environmental category on the device.

(5) Multiple Device Markings will be inside parentheses. Only one Device Marking contained in parentheses and separated by a "~" will appear on a device. If a line is indented then it is a continuation of the previous line and the two combined represent the entire Device Marking for that device.

(6) Lead finish/Ball material - Orderable Devices may have multiple material finish options. Finish options are separated by a vertical ruled line. Lead finish/Ball material values may wrap to two lines if the finish value exceeds the maximum column width.

Important Information and Disclaimer:The information provided on this page represents TI's knowledge and belief as of the date that it is provided. TI bases its knowledge and belief on information provided by third parties, and makes no representation or warranty as to the accuracy of such information. Efforts are underway to better integrate information from third parties. TI has taken and continues to take reasonable steps to provide representative and accurate information but may not have conducted destructive testing or chemical analysis on incoming materials and chemicals. TI and TI suppliers consider certain information to be proprietary, and thus CAS numbers and other limited information may not be available for release.

In no event shall TI's liability arising out of such information exceed the total purchase price of the TI part(s) at issue in this document sold by TI to Customer on an annual basis.

TAPE AND REEL INFORMATION



QUADRANT ASSIGNMENTS FOR PIN 1 ORIENTATION IN TAPE



*All dimensions are nominal

Device	Package Type	Package Drawing	Pins	SPQ	Reel Diameter (mm)	Reel Width W1 (mm)	A0 (mm)	B0 (mm)	K0 (mm)	P1 (mm)	W (mm)	Pin1 Quadrant
CDCVF25084PWR	TSSOP	PW	16	2000	330.0	12.4	6.9	5.6	1.6	8.0	12.0	Q1

TAPE AND REEL BOX DIMENSIONS



*All dimensions are nominal

Device	Package Type	Package Drawing	Pins	SPQ	Length (mm)	Width (mm)	Height (mm)
CDCVF25084PWR	TSSOP	PW	16	2000	853.0	449.0	35.0



4220204/A 02/2017

NOTES:

1. All linear dimensions are in millimeters. Any dimensions in parenthesis are for reference only. Dimensioning and tolerancing per ASME Y14.5M.
2. This drawing is subject to change without notice.
3. This dimension does not include mold flash, protrusions, or gate burrs. Mold flash, protrusions, or gate burrs shall not exceed 0.15 mm per side.
4. This dimension does not include interlead flash. Interlead flash shall not exceed 0.25 mm per side.
5. Reference JEDEC registration MO-153.

EXAMPLE BOARD LAYOUT

PW0016A

TSSOP - 1.2 mm max height

SMALL OUTLINE PACKAGE



LAND PATTERN EXAMPLE
EXPOSED METAL SHOWN
SCALE: 10X



4220204/A 02/2017

NOTES: (continued)

- 6. Publication IPC-7351 may have alternate designs.
- 7. Solder mask tolerances between and around signal pads can vary based on board fabrication site.

EXAMPLE STENCIL DESIGN

PW0016A

TSSOP - 1.2 mm max height

SMALL OUTLINE PACKAGE



SOLDER PASTE EXAMPLE
BASED ON 0.125 mm THICK STENCIL
SCALE: 10X

4220204/A 02/2017

NOTES: (continued)

8. Laser cutting apertures with trapezoidal walls and rounded corners may offer better paste release. IPC-7525 may have alternate design recommendations.
9. Board assembly site may have different recommendations for stencil design.

IMPORTANT NOTICE AND DISCLAIMER

TI PROVIDES TECHNICAL AND RELIABILITY DATA (INCLUDING DATASHEETS), DESIGN RESOURCES (INCLUDING REFERENCE DESIGNS), APPLICATION OR OTHER DESIGN ADVICE, WEB TOOLS, SAFETY INFORMATION, AND OTHER RESOURCES "AS IS" AND WITH ALL FAULTS, AND DISCLAIMS ALL WARRANTIES, EXPRESS AND IMPLIED, INCLUDING WITHOUT LIMITATION ANY IMPLIED WARRANTIES OF MERCHANTABILITY, FITNESS FOR A PARTICULAR PURPOSE OR NON-INFRINGEMENT OF THIRD PARTY INTELLECTUAL PROPERTY RIGHTS.

These resources are intended for skilled developers designing with TI products. You are solely responsible for (1) selecting the appropriate TI products for your application, (2) designing, validating and testing your application, and (3) ensuring your application meets applicable standards, and any other safety, security, or other requirements. These resources are subject to change without notice. TI grants you permission to use these resources only for development of an application that uses the TI products described in the resource. Other reproduction and display of these resources is prohibited. No license is granted to any other TI intellectual property right or to any third party intellectual property right. TI disclaims responsibility for, and you will fully indemnify TI and its representatives against, any claims, damages, costs, losses, and liabilities arising out of your use of these resources.

TI's products are provided subject to TI's Terms of Sale (www.ti.com/legal/termsofsale.html) or other applicable terms available either on ti.com or provided in conjunction with such TI products. TI's provision of these resources does not expand or otherwise alter TI's applicable warranties or warranty disclaimers for TI products.

Mailing Address: Texas Instruments, Post Office Box 655303, Dallas, Texas 75265
Copyright © 2020, Texas Instruments Incorporated