

General Description

The MIC2095/97/98/99 family of switches are self-contained, current-limiting, high-side power switches, ideal for power-control applications. These switches are useful for general purpose power distribution applications such as digital televisions (DTV), printers, set-top boxes (STB), PCs, PDAs, and other peripheral devices.

The current limiting switches feature either a fixed 0.5A/0.9A or resistor programmable output current limit. The family also has fault blanking to eliminate false noise-induced, over current conditions. After an over-current condition, these devices automatically restart if the enable pin remains active. The MIC2097 switch offers a unique new patented Kickstart feature, which allows momentary high-current surges up to the secondary current limit (I_{LIMIT_2nd}). This is useful for charging loads with high inrush currents, such as capacitors.

The MIC2095/97/98/99 family of switches provides under-voltage, over-temperature shutdown, and output fault status reporting. The family also provides either an active low or active high, logic level enable pin.

The MIC2095/97/98/99 family is offered in a space saving 1.6mm x 1.6mm Thin MLF[®] (TMLF) package.

Datasheets and support documentation can be found on Micrel's web site at: www.micrel.com.

Features

- MIC2095: 0.5A fixed current limit
- MIC2098: 0.9A fixed current limit
- MIC2097/99: Resistor programmable current limit – 0.1A to 1.1A
- MIC2097: Kickstart for high peak current loads
- Under voltage lock-out (UVLO)
- Soft start prevents large current inrush
- Automatic-on output after fault
- Thermal protection
- Enable active high or active low
- 170mΩ typical on-resistance @ 5V
- 2.5V – 5.5V operating range

Applications

- Digital televisions (DTV)
- Set top boxes
- PDAs
- Printers
- USB / IEEE 1394 power distribution
- Desktop and laptop PCs
- Game consoles
- USB keyboard
- Docking stations

Typical Application

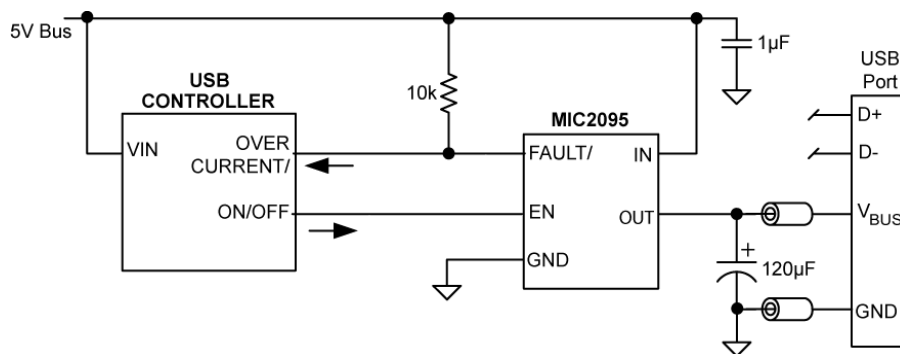

MIC2095 USB Power Switch

Ordering Information

Part Number	Marking	ENABLE Logic	Kickstart ^(TM)	ILIMIT	FAULT/ Output	Junction Temperature Range ⁽¹⁾	Package
MIC2095-1YMT	J1K	Active High	No	0.5A	Yes	-40°C to +125°C	6-Pin 1.6mm x 1.6mm TMLF
MIC2095-2YMT	J2K	Active Low	No	0.5A	Yes	-40°C to +125°C	6-Pin 1.6mm x 1.6mm TMLF
MIC2097-1YMT	K1K	Active High	Yes	0.1 A – 1.1A	Yes	-40°C to +125°C	6-Pin 1.6mm x 1.6mm TMLF
MIC2097-2YMT	K2K	Active Low	Yes	0.1 A – 1.1A	Yes	-40°C to +125°C	6-Pin 1.6mm x 1.6mm TMLF
MIC2098-1YMT	H1K	Active High	No	0.9A	Yes	-40°C to +125°C	6-Pin 1.6mm x 1.6mm TMLF
MIC2098-2YMT	H2K	Active Low	No	0.9A	Yes	-40°C to +125°C	6-Pin 1.6mm x 1.6mm TMLF
MIC2099-1YMT	G1K	Active High	No	0.1 A – 1.1A	Yes	-40°C to +125°C	6-Pin 1.6mm x 1.6mm TMLF
MIC2099-2YMT	G2K	Active Low	No	0.1 A – 1.1A	Yes	-40°C to +125°C	6-Pin 1.6mm x 1.6mm TMLF

Pin Configuration

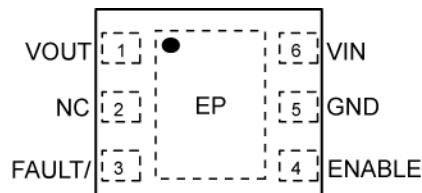

6-Pin 1.6mm x 1.6mm TMLF (MT) (Top View)
MIC2095-1YMT/MIC2098-1YMT

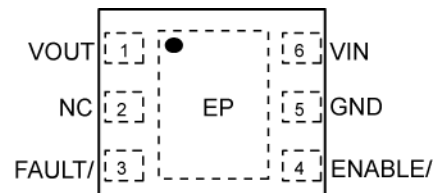

6-Pin 1.6mm x 1.6mm TMLF (MT) (Top View)
MIC2095-2YMT/MIC2098-2YMT

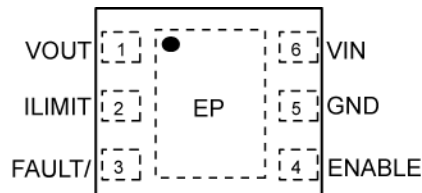

6-Pin 1.6mm x 1.6mm TMLF (MT) (Top View)
MIC2097-1YMT / MIC2099-1YMT

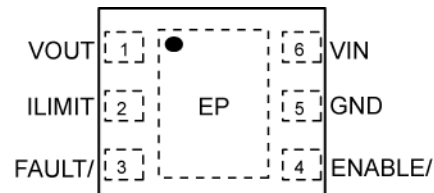

6-Pin 1.6mm x 1.6mm TMLF (MT) (Top View)
MIC2097-2YMT / MIC2099-2YMT

Pin Description

Pin Number	Pin Name	Pin Function
1	VOUT	Switch output (Output): The load being driven by the switch is connected to this pin.
2 (MIC2095/MIC2098)	NC	No Connect; Pin not used.
2 (MIC2097/MIC2099)	ILIMIT	Current Limit (Input): A resistor from this pin to ground sets the current limit value. See the "setting I_{LIMIT} " section for details on setting the resistor value.
3	FAULT/	Fault status (Output): A logic low on this pin indicates the switch is in current limiting, or has been shut down by the thermal protection circuit. This is an open-drain output allowing logical OR'ing of FAULT/ outputs from multiple devices.
4 (MIC2095-1/MIC2097-1/ MIC2098-1/MIC2099-1)	ENABLE	Switch Enable (Input): Logic high on this pin enables the switch.
4 (MIC2095-2/MIC2097-2/ MIC2098-2/MIC2099-2)	ENABLE/	Switch Enable (Input): Logic low on this pin enables the switch.
5	GND	Ground.
6	VIN	Power input (Input): This pin provides power to both the output power switch and the internal control circuitry.
EP	EP	Used to remove heat from die. Connect to ground. Use multiple vias to the ground plane to minimize thermal impedance. See Applications Section for additional information.

Absolute Maximum Ratings⁽¹⁾

Supply Voltage (V_{IN})	-0.3V to 6.0V
Output Voltage (V_{OUT})	-0.3V to V_{IN}
FAULT Pin Voltage (V_{FAULT})	-0.3V to V_{IN}
ENABLE Pin Voltage (V_{ENABLE})	-0.3V to V_{IN}
ILIMIT Pin Voltage (V_{ILIMIT})	-0.3V to V_{IN}
Power Dissipation (P_D)	Internally Limited
Maximum Junction Temperature (T_J)	150°C
Storage Temperature (T_s)	-65°C to +150°C
Lead Temperature (soldering, 10sec.)	260°C
ESD HBM Rating (V_{OUT} , GND) ⁽³⁾	4kV
ESD HBM Rating (FAULT, ENABLE, VIN) ⁽³⁾	2kV

Operating Ratings⁽²⁾

Supply Voltage (V_{IN})	2.5V to 5.5V
ENABLE Pin Voltage (V_{ENABLE})	0V to V_{IN}
FAULT Pin Voltage (V_{FAULT})	0V to V_{IN}
Ambient Temperature Range (T_A)	-40°C to +85°C
Package Thermal Resistance ⁽⁶⁾ 1.6mm × 1.6mm TMLF (θ_{JA})	93°C/W

Electrical Characteristics⁽⁴⁾

$V_{IN} = 5V$; $C_{IN} = 1\mu F$ $T_A = 25^\circ C$ unless noted, **bold** values indicate $-40^\circ C \leq T_A \leq +85^\circ C$.

Symbol	Parameter	Condition	Min.	Typ.	Max.	Units
Power Input Supply						
V_{IN}	Input Voltage Range		2.5		5.5	V
I_{IN}	Quiescent Supply Current ⁽⁵⁾	Switch = ON Active Low Enable, $V_{EN} = 0V$ Active High Enable, $V_{EN} = 1.5V$		80	300	μA
		Switch = OFF Active Low Enable, $V_{EN} = 1.5V$		8	15	μA
	Shutdown Current	Switch = OFF Active High Enable, $V_{EN} = 0.5V$		0.1	5	μA
$UVLO_{THRESHOLD}$	V_{IN} UVLO Threshold	V_{IN} Rising	2	2.25	2.5	V
		V_{IN} Falling	1.9	2.15	2.4	V
	V_{IN} UVLO Hysteresis			100		mV
Enable Control						
V_{EN}	ENABLE Logic Level Low ⁽⁵⁾	$V_{IL(MAX)}$			0.5	V
	ENABLE Logic Level High ⁽⁵⁾	$V_{IH(MIN)}$	1.5			V
I_{EN}	ENABLE Bias Current	$0V \leq V_{EN} \leq 5V$		0.1	5	μA
t_{ON_DLY}	Output Turn-on Delay	$R_L = 43\Omega$, $C_L = 120\mu F$ $V_{EN} = 50\%$ to $V_{OUT} = 10\%$		1000	1500	μs
t_{OFF_DLY}	Output Turn-off Delay	$R_L = 43\Omega$, $C_L = 120\mu F$ $V_{EN} = 50\%$ to $V_{OUT} = 90\%$			700	μs
t_{RISE}	Output Turn-on rise time	$R_L = 100\Omega$, $C_{LOAD} = 1\mu F$ $V_{OUT} = 10\%$ to 90%	500	1000	1500	μs
Thermal Protection						
$OT_{Threshold}$	Over-temperature Shutdown	T_J Rising		145		$^\circ C$
		T_J Falling		135		$^\circ C$

Electrical Characteristics (Continued)

$V_{IN} = 5V$; $C_{IN} = 1\mu F$ $T_A = 25^\circ C$ unless noted, **bold** values indicate $-40^\circ C \leq T_A \leq +85^\circ C$.

Symbol	Parameter	Condition	Min.	Typ.	Max.	Units
Internal Switch						
$R_{DS(ON)}$	On Resistance	$V_{IN} = 5V, I_{OUT} = 100mA$		170	220	m Ω
					275	m Ω
I_{LEAK}	Output Leakage Current	Switch = OFF, $V_{OUT} = 0V$ Active Low Enable, $V_{EN} = 1.5V$ Active High Enable, $V_{EN} = 0V$		0.1	10	μA
Output Current Limit (MIC2095)						
I_{LIMIT}	Fixed Current Limit	$V_{OUT} = 0.8 \times V_{IN}$	0.5	0.7	0.9	A
Output Current Limit (MIC2098)						
I_{LIMIT}	Fixed Current Limit	$V_{OUT} = 0.8 \times V_{IN}$	0.9	1.1	1.5	A
Output Current Limit (MIC2097, MIC2099)						
CLF	Variable Current Limit Factors	$I_{OUT} = 1.1A, V_{OUT} = 0.8 \times V_{IN}; V_{IN} = 2.5V$	175	215	263	V
		$I_{OUT} = 0.5A, V_{OUT} = 0.8 \times V_{IN}; V_{IN} = 2.5V$	152	206	263	V
		$I_{OUT} = 0.2A, V_{OUT} = 0.8 \times V_{IN}; V_{IN} = 2.5V$	138	200	263	V
		$I_{OUT} = 0.1A, V_{OUT} = 0.8 \times V_{IN}; V_{IN} = 2.5V$	121	192	263	V
Kickstart™ Current Limit (MIC2097)						
I_{LIMIT_2nd}	Secondary Current Limit	$V_{IN} = 2.5V; V_{OUT} = 0V$		1.5		A
t_{D_LIMIT}	Duration of Kickstart™ Current Limit	$V_{IN} = 2.5V$	77	105	192	ms
Fault Flag						
$V_{FAULT/}$	Fault Flag Output Voltage	$I_{OL} = 10mA$		0.25	0.4	V
	Fault Flag Off Current	$V_{FAULT/} = 5V$		0.01	1	μA
Fault Delay (MIC2095, MIC2098, MIC2099)						
t_{D_FAULT}	Delay before asserting or releasing FAULT/	Time from current limiting ($V_{OUT} = 0.4 \times V_{IN}$) to FAULT/ state change	20	32	49	ms
Fault Delay (MIC2097)						
t_{D_FAULT}	Delay before asserting or releasing FAULT/	Time from current limiting ($V_{OUT} = 0.8 \times V_{IN}$) to FAULT/ state change; $V_{IN} = 2.5V$	77	105	192	ms

Notes:

- Exceeding the absolute maximum rating may damage the device.
- The device is not guaranteed to function outside its operating rating.
- Devices are ESD sensitive. Handling precautions recommended. Human body model, 1.5k in series with 100pF.
- Specifications for packaged product only.
- Check the Ordering Information section to determine which parts are Active High or Active Low.
- Requires proper thermal mounting to achieve this performance.

Timing Diagrams

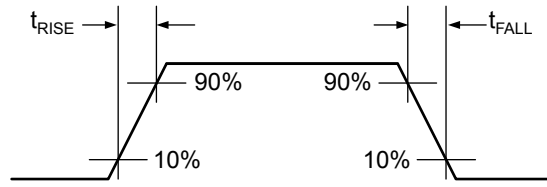

Rise and Fall Times

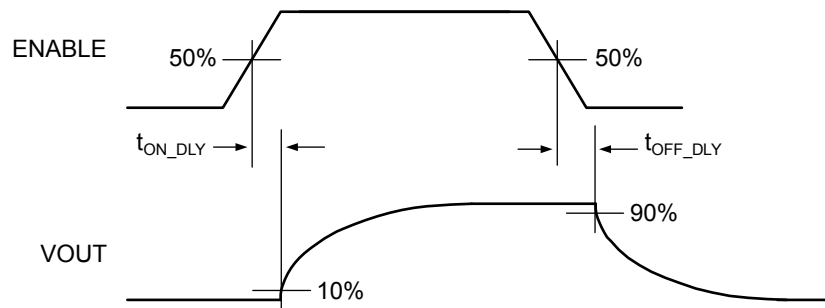

Switching Delay Times

Typical Characteristics

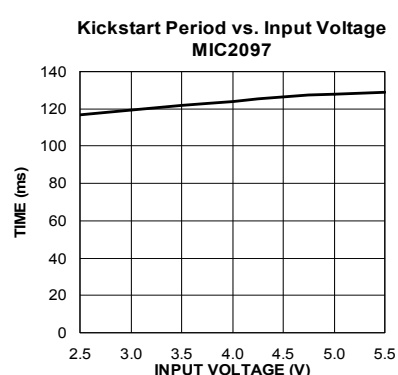
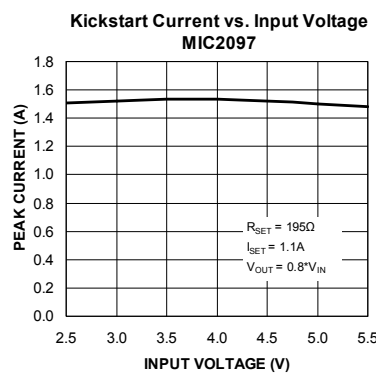
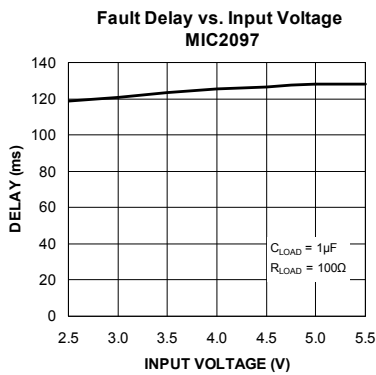
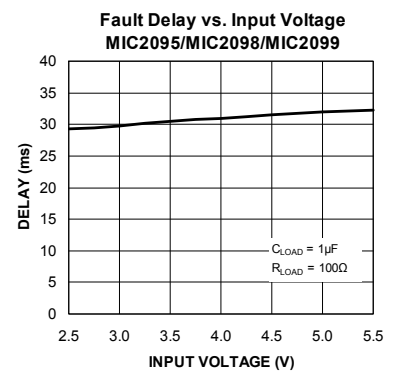
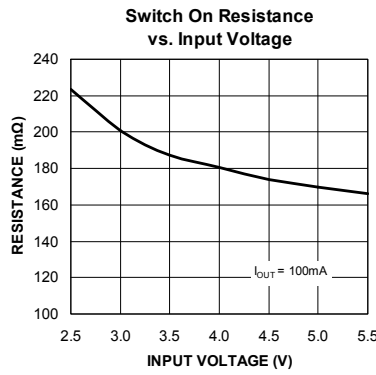
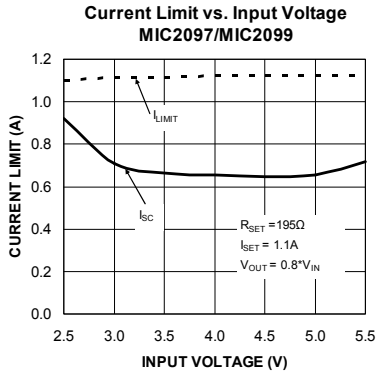
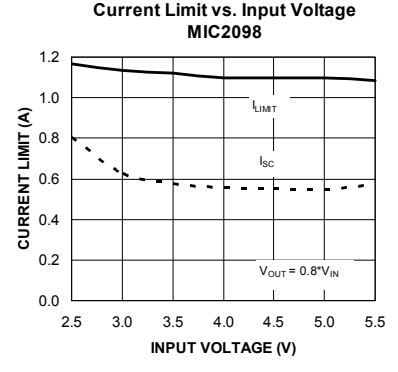
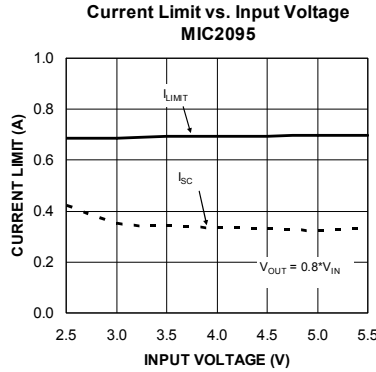
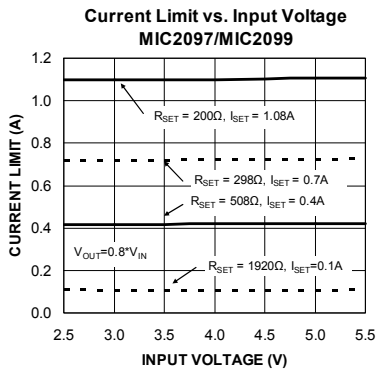
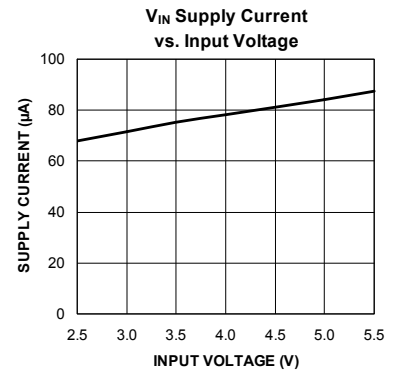
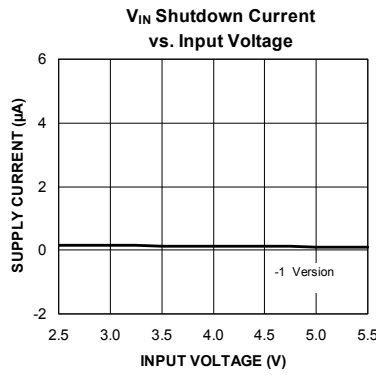
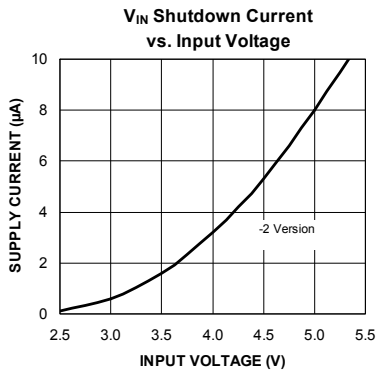

Typical Characteristics (Continued)

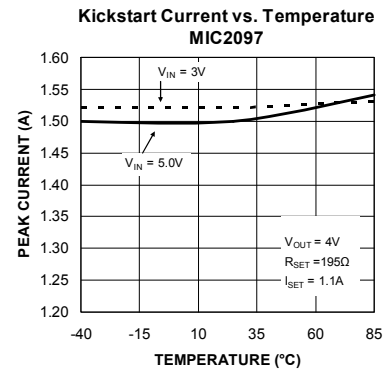
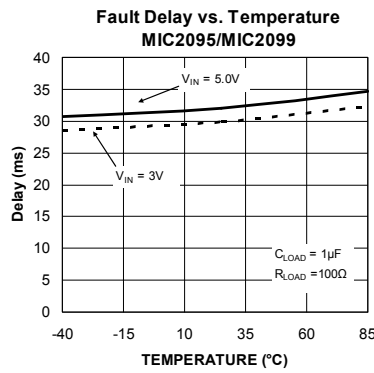
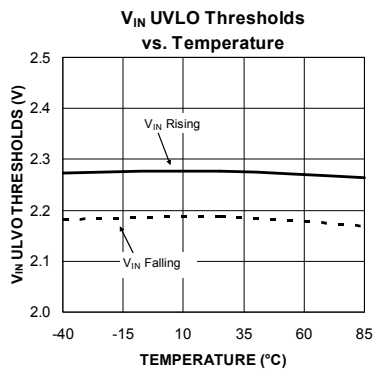
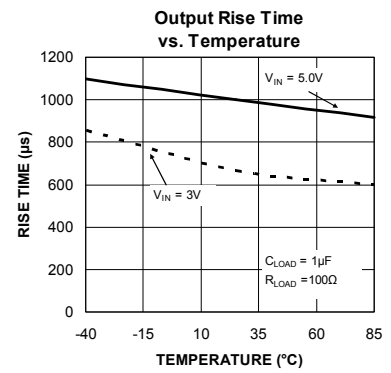
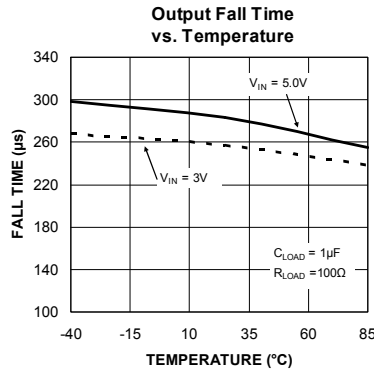
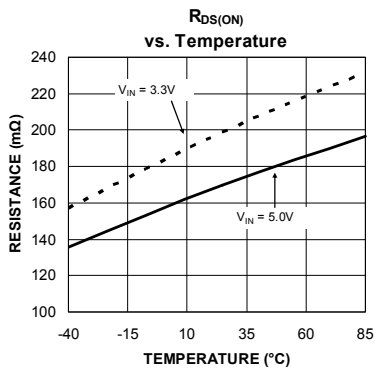
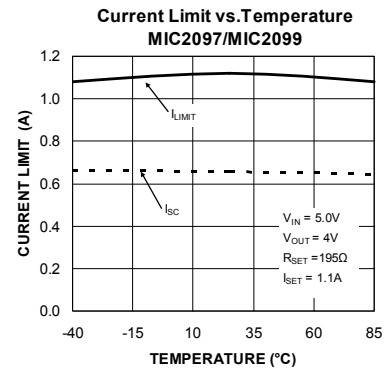
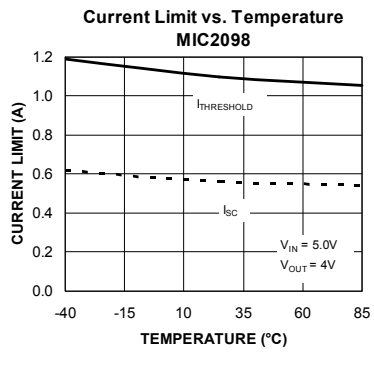
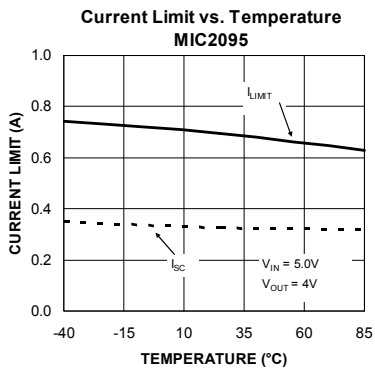
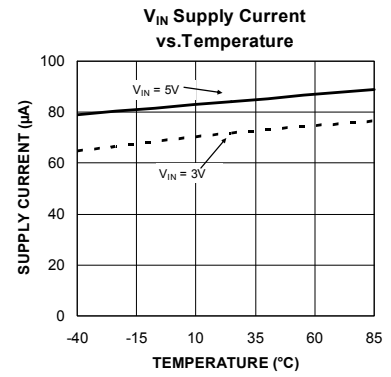
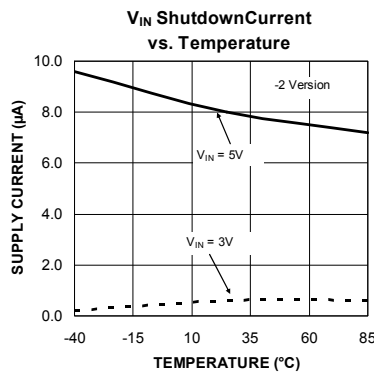
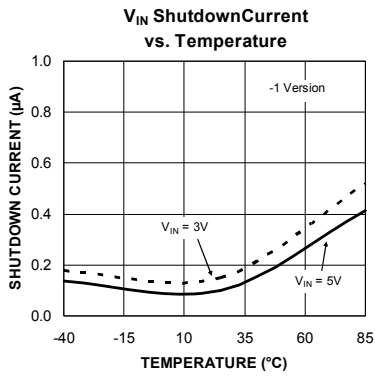

Typical Characteristics (Continued)

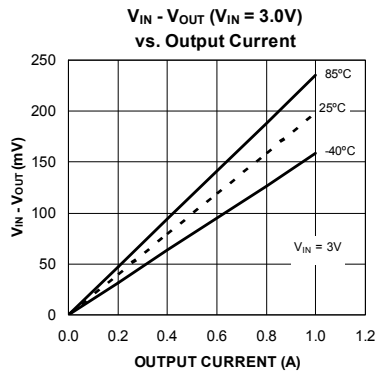
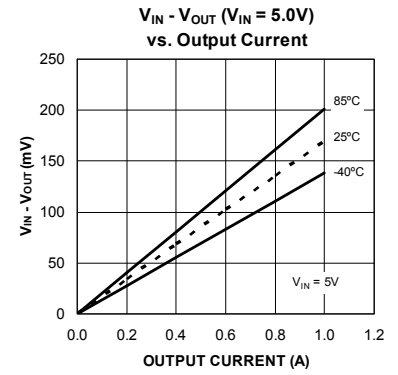
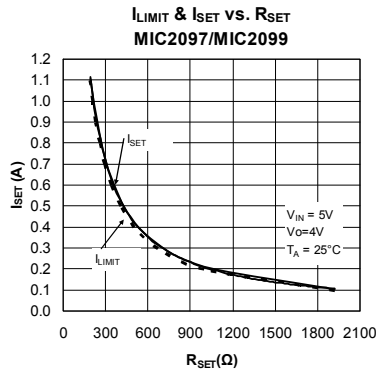
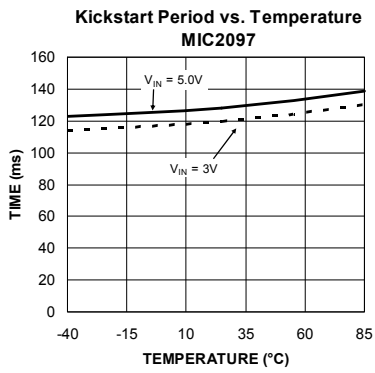

Functional Characteristics

V_{IN} Soft Turn-On

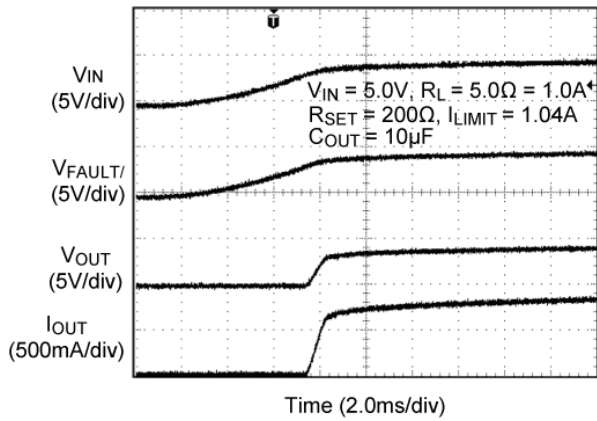

V_{IN} Soft Turn-Off

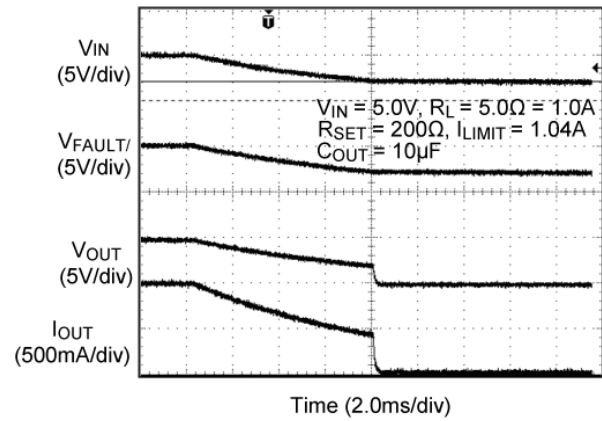

V_{IN} UVLO Thresholds

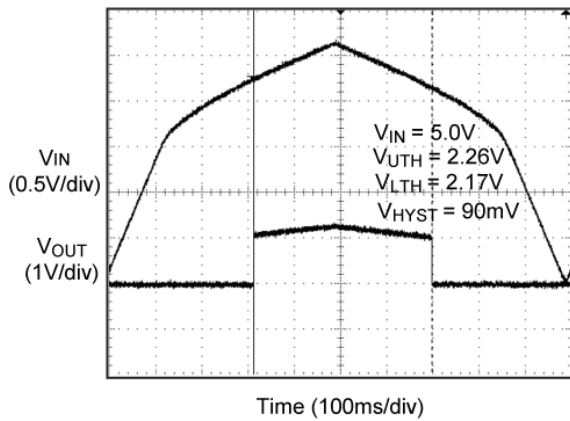

Enable Turn-On/Turn-Off

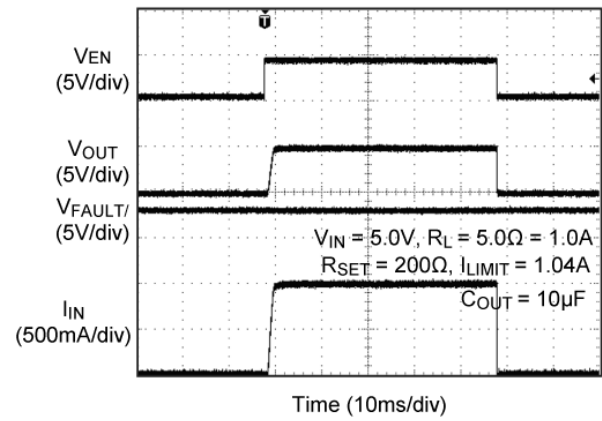

Enable Turn-On Delay and Rise Time

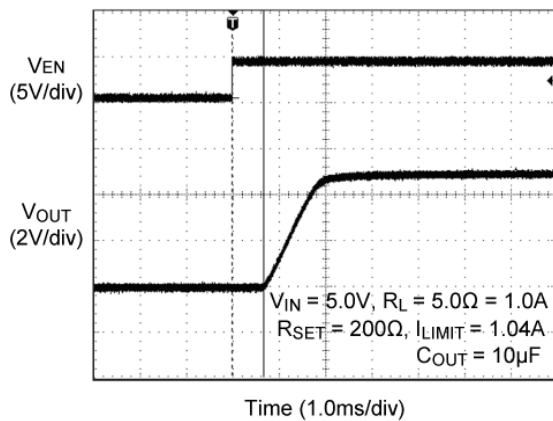

Enable Turn-Off Delay and Fall Time

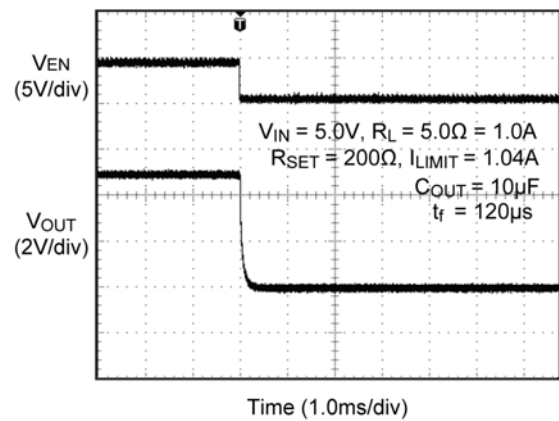

Functional Characteristics (Continued)

Enable Thresholds

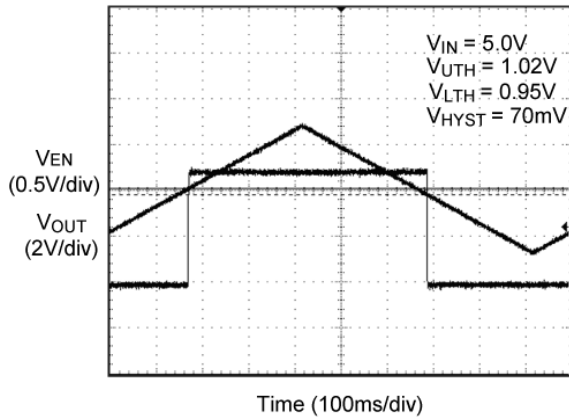

2095 Enabled into a Short

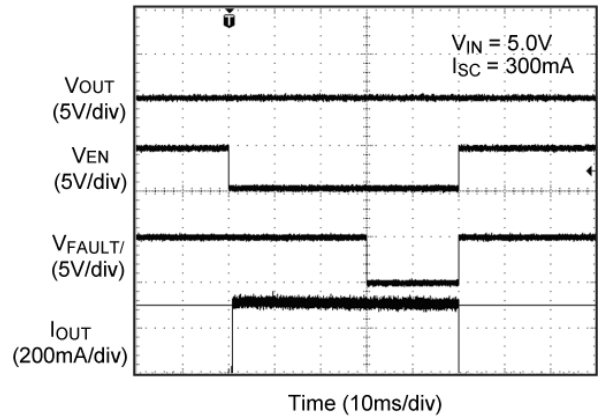

2098 Enabled into a Short

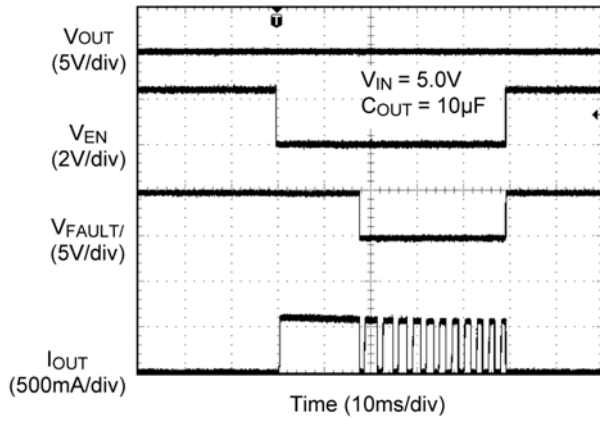

2099 Enabled into a Short

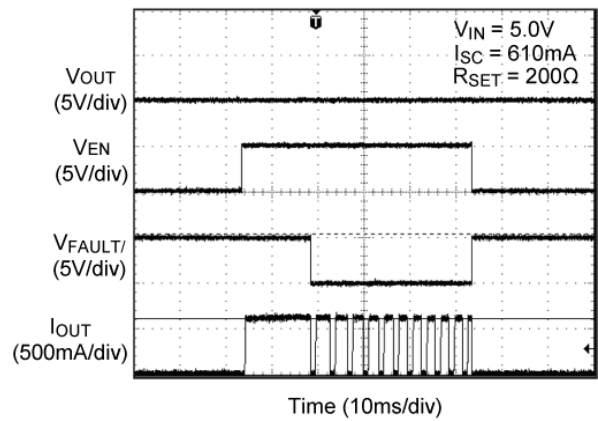

2097 Enabled into an Overcurrent Condition

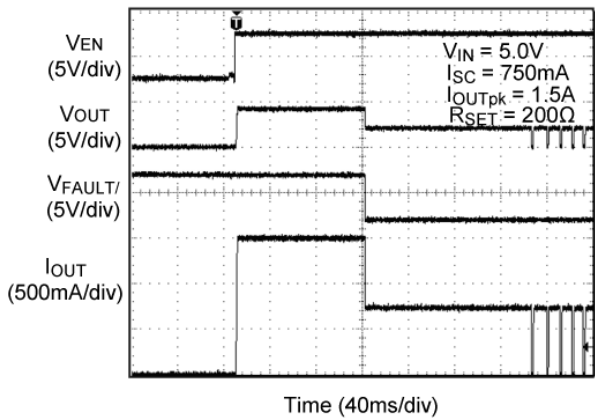

2095 Power Up into Short Circuit

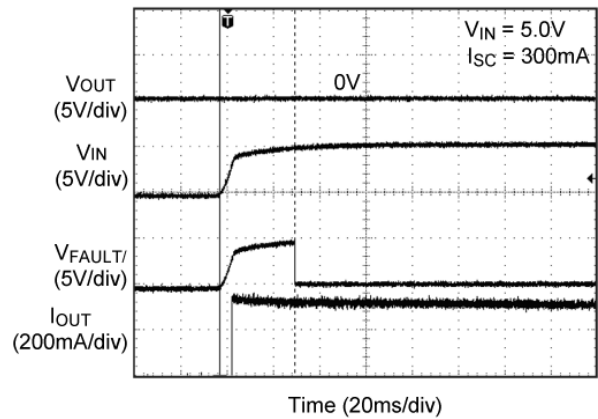

Functional Characteristics (Continued)

2098 Power Up into Short Circuit

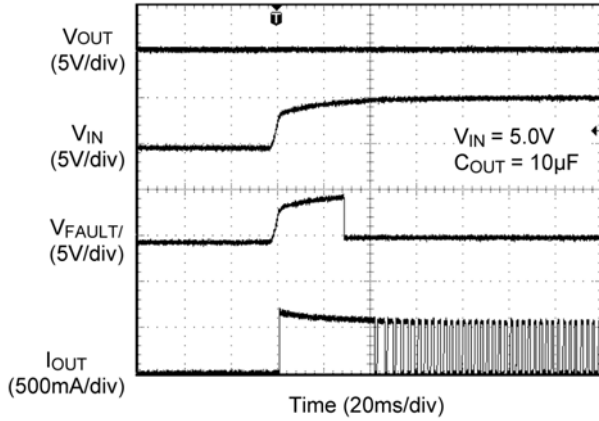

2099 Power Up into Short Circuit

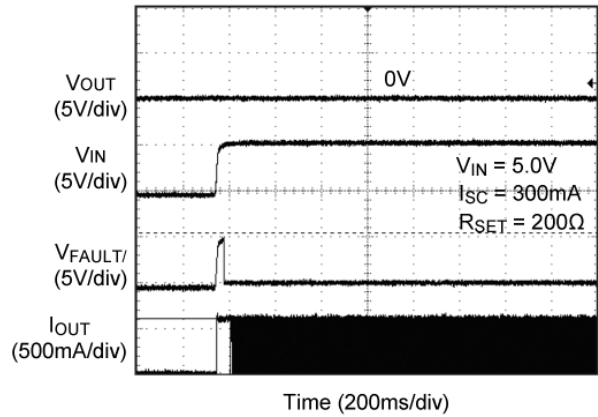

2097 Power Up into Short Circuit

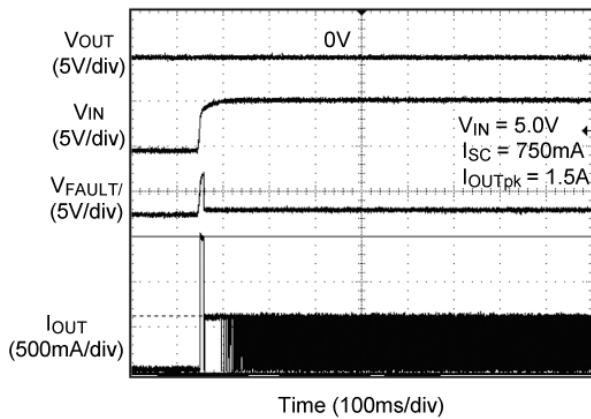

2095 Output Recovery from Short Circuit and Fault/ Response

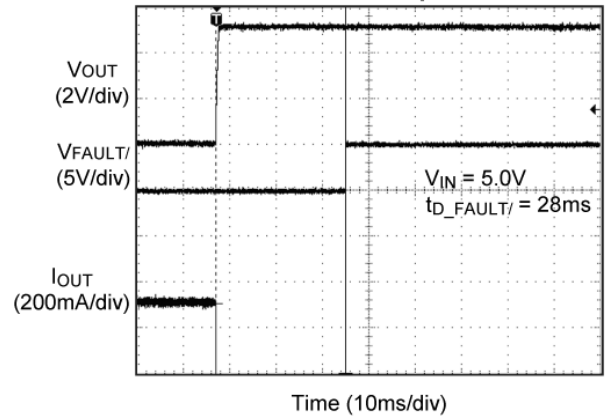

2098 Output Recovery from Short Circuit and FAULT/Response

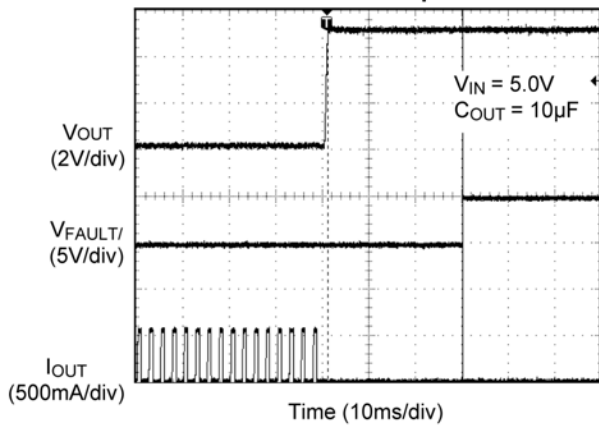

2099 Output Recovery from Short Circuit and Fault/ Response

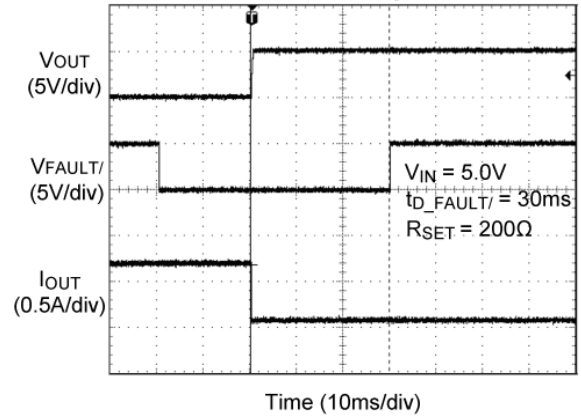

Functional Characteristics (Continued)

2097 Output Recovery from Short Circuit and Fault/ Response

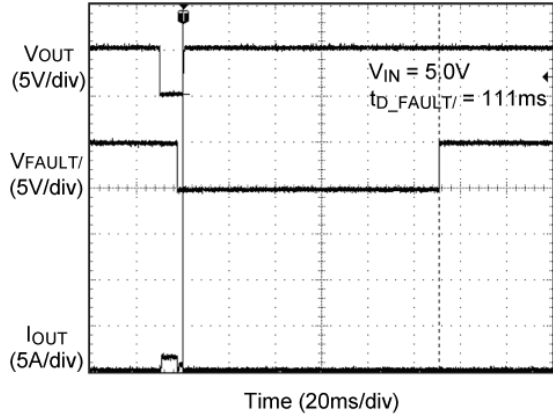

2095 Inrush Current Response

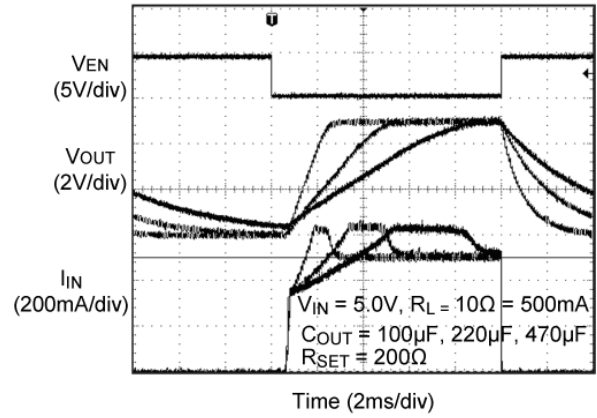

2098 Inrush Current Response

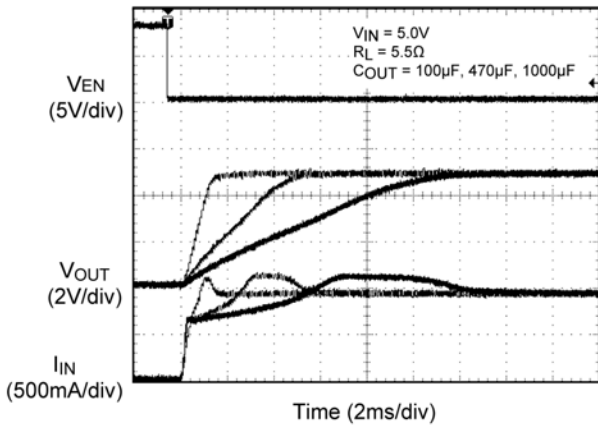

2099 Inrush Current Response

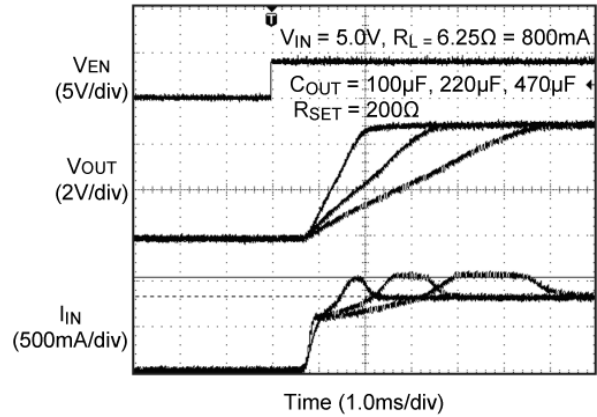

2097 Inrush Current Response

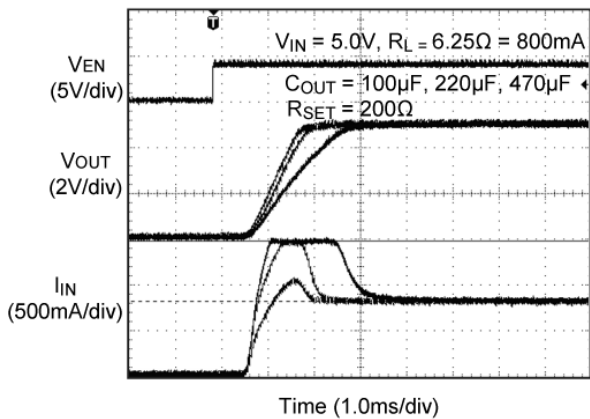

2095 Output Recovery from Thermal Shutdown

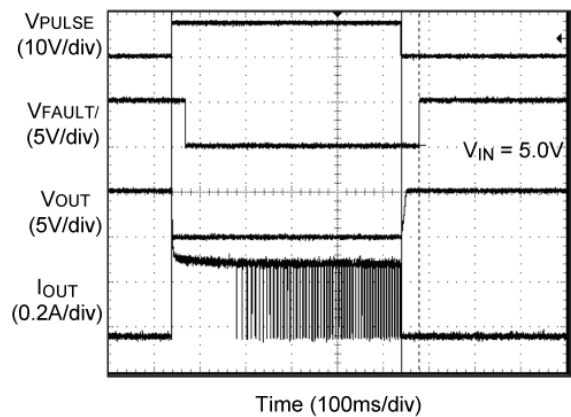

Functional Characteristics (Continued)

2098 Output Recovery from Thermal Shutdown

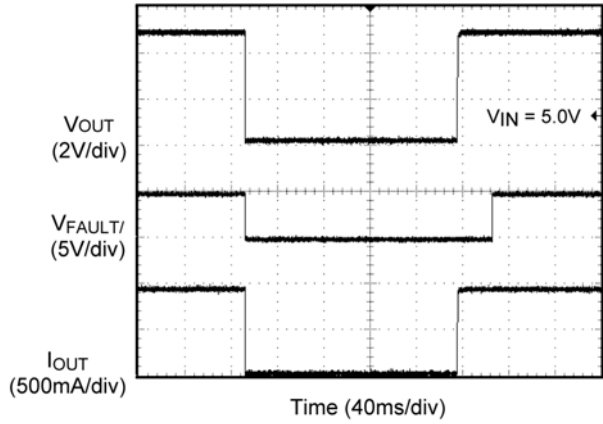

2099 Output Recovery from Thermal Shutdown

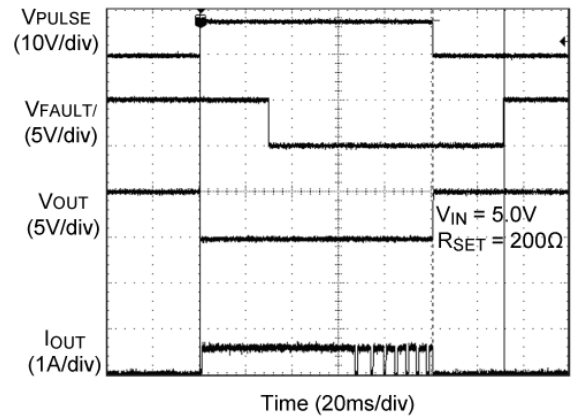

2097 Output Recovery from Thermal Shutdown

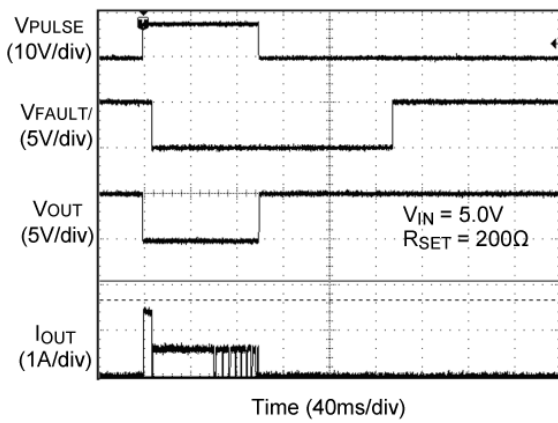

Functional Diagram

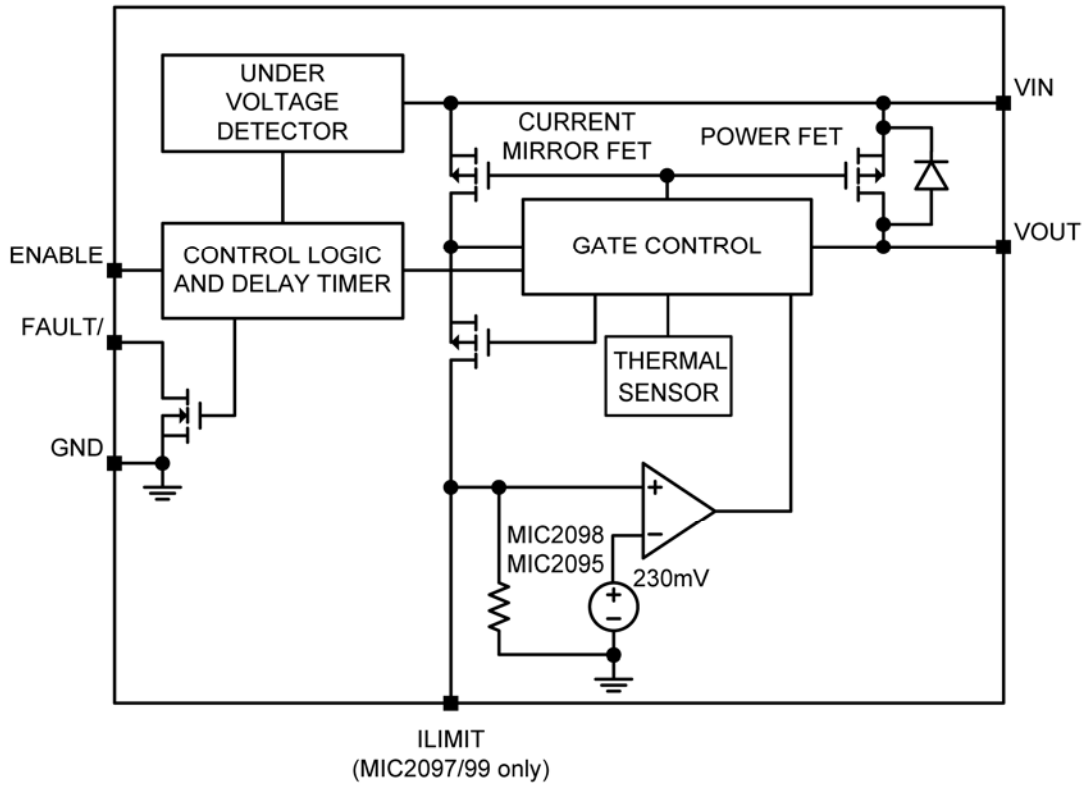

MIC2095/97/98/99 Functional Diagram

Functional Description and Application Information

V_{IN} and V_{OUT}

V_{IN} is both the power supply connection for the internal circuitry driving the switch and the input (Source connection) of the power MOSFET switch. V_{OUT} is the Drain connection of the power MOSFET and supplies power to the load. In a typical circuit, current flows from V_{IN} to V_{OUT} toward the load. Since the switch is bi-directional when enabled, if V_{OUT} is greater than V_{IN} , current will flow from V_{OUT} to V_{IN} .

When the switch is disabled, current will not flow to the load, except for a small unavoidable leakage current of a few micro amps. However, should V_{OUT} exceed V_{IN} by more than a diode drop (~0.6V), while the switch is disabled, current will flow from output to input via the power MOSFET's body diode. When the switch is enabled, current can flow both ways, from V_{IN} to V_{OUT} , or V_{OUT} to V_{IN} .

C_{IN}

A minimum 1 μ F bypass capacitor positioned as close as possible to the V_{IN} and GND pins of the switch is both good design practice and required for proper operation of the switch. This will control supply transients and ringing. Without a sufficient bypass capacitor, large current surges or a short may cause sufficient ringing on V_{IN} (from supply lead inductance) to cause erratic operation of the switch's control circuitry. For best performance a good quality, low-ESR ceramic capacitor is recommended.

An additional 22 μ F (or greater) capacitor, positioned close to the V_{IN} and GND pins of the switch is necessary if the distance between a larger bulk capacitor and the switch is greater than 3 inches. This additional capacitor limits input voltage transients at the switch caused by fast changing input currents that occur during a fault condition, such as current limit and thermal shutdown.

When bypassing with capacitors of 10 μ F and up, it is good practice to place a smaller value capacitor in parallel with the larger to handle the high frequency components of any line transients. Values in the range of 0.1 μ F to 1 μ F are recommended. Again, good quality, low-ESR capacitors, preferably ceramic, should be chosen.

C_{OUT}

An output capacitor is recommended to reduce ringing and voltage sag on the output during a transient condition. A value between 1 μ F and 10 μ F is recommended, however, larger values can be used.

Limitations on C_{OUT}

The part may enter current limit when turning on with a large output capacitance. This is an acceptable condition, however, if the part remains in current limit for a time greater than t_{D_FAULT} , the FAULT pin will assert low. The maximum value of C_{OUT} may be approximated by the following equation:

$$C_{OUT_MAX} = \frac{I_{LIMIT_MIN} \times t_{D_FAULT_MIN}}{V_{IN_MAX}} \quad \text{Eq. 1}$$

Where: I_{LIMIT_MIN} and $t_{D_FAULT_MIN}$ are the minimum specified values listed in the Electrical Characteristic table and V_{IN_MAX} is the maximum input voltage to the switch.

Current Sensing and Limiting

The current limiting switches protect the system power supply and load from damage by continuously monitoring current through the on-chip power MOSFET. Load current is monitored by means of a current mirror in parallel with the power MOSFET switch. Current limiting is invoked when the load exceeds the over-current threshold. When current limiting is activated the output current is constrained to the limit value, and remains at this level until either the load/fault is removed, the load's current requirement drops below the limiting value, or the switch goes into thermal shutdown.

Kickstart™

The MIC2097 has a Kickstart feature that allows higher momentary current surges before the onset of current limiting. This permits dynamic loads, such as small disk drives or portable printers to draw the inrush current needed to overcome inertial loads without sacrificing system safety. The Kickstart parts differ from the non-Kickstart parts which more rapidly limit load current, potentially starving a motor and causing the appliance to stall or stutter.

During the Kickstart delay period, (typically 105ms), a secondary current limit (nominally set at 1.5A), is in effect. If the load demands a current in excess the secondary limit, Kickstart parts act immediately to restrict output current to the secondary limit for the duration of the Kickstart period. After this time the Kickstart parts revert to their normal current limit. An example of Kickstart operation is in Figure 1.

Kickstart may be over-ridden by the thermal protection circuit and if sufficient internal heating occurs, Kickstart will be terminated and the output switch will be turned off. After the parts cools, if the load is still present $I_{OUT} \rightarrow I_{LIMIT}$, not I_{LIMIT_2nd} .

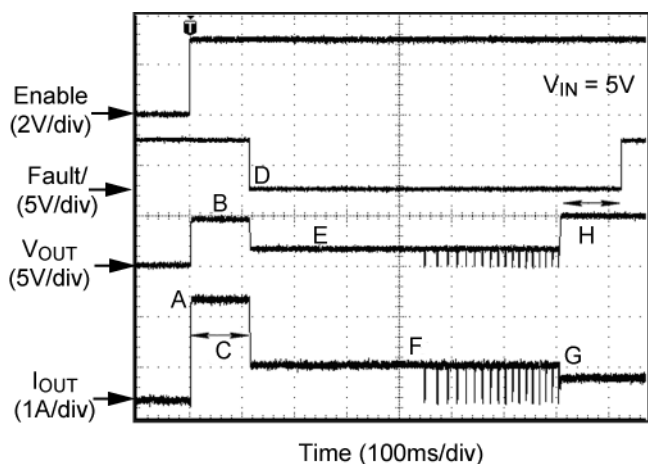

Figure 1. MIC2097 Kickstart Operation

Figure 1 Label Key:

- A. The MIC2097 is enabled into an excessive load (slew-rate limiting not visible at this time scale) The initial current surge is limited by either the overall circuit resistance and power-supply compliance, or the secondary current limit, whichever is less.
- B. R_{ON} of the power FET increases due to internal heating.
- C. Kickstart period.
- D. Current limiting initiated. FAULT/ goes low.
- E. V_{OUT} is non-zero (load is heavy, but not a dead short where $V_{OUT} = 0V$. Limiting response will be the same for dead shorts).
- F. Thermal shutdown followed by thermal cycling.
- G. Excessive load released, normal load remains. MIC2097 drops out of current limiting.
- H. FAULT/ delay period followed by FAULT/ going HIGH.

Enable Input

The ENABLE pin is a logic level compatible input which turns on or off the main MOSFET switch. There are two versions of each device. The -1 version has an active high (ENABLE) and the -2 version has an active low (ENABLE/).

Fault Output

The FAULT/ is an N-channel open-drain output, which is asserted (LOW true) when the device either begins current limiting or enters thermal shutdown. The FAULT/ signal asserts after a brief delay period in order to filter out very brief over current conditions. After an over-current or over-temperature fault clears, the FAULT/ pin remains asserted (low) for the delay period.

The FAULT/output is open-drain and must be pulled HIGH with an external resistor. The FAULT/ signal may be wire-OR'd with other similar outputs, sharing a single

pull-up resistor. FAULT/ may be tied to a pull-up voltage source which is less than or equal to V_{IN} .

Soft-Start Control

Large capacitive loads can create significant inrush current surges when charged through the current limiting switch. When the switch is enabled, the built-in soft-start limits the initial inrush current by slowly turning on the output.

Power Dissipation and Thermal Shutdown

Thermal shutdown is used to protect the current limiting switch from damage should the die temperature exceed a safe operating temperature. Thermal shutdown shuts off the output MOSFET and asserts the FAULT/ output if the die temperature reaches 145°C (typical).

The switch will automatically resume operation when the die temperature cools down to 135°C. If resumed operation results in reheating of the die, another shutdown cycle will occur and the switch will continue cycling between ON and OFF states until the reason for the overcurrent condition has been resolved.

Depending on PCB layout, package type, ambient temperature, etc., hundreds of milliseconds may elapse from the time a fault occurs to the time the output MOSFET will be shut off. This delay is caused because of the time it takes for the die to heat after the fault condition occurs.

Power dissipation depends on several factors such as the load, PCB layout, ambient temperature, and supply voltage. Calculation of power dissipation can be accomplished by the following equation:

$$P_D = R_{DS(ON)} \times (I_{OUT})^2 \quad \text{Eq. 2}$$

To relate this to junction temperature, the following equation can be used:

$$T_J = P_D \times R_{\theta(J-A)} + T_A \quad \text{Eq. 3}$$

Where T_J = junction temperature, T_A = ambient temperature, and $R_{\theta(J-A)}$ is the thermal resistance of the package.

In normal operation, excessive switch heating is most often caused by an output short circuit. If the output is shorted, when the switch is enabled, the switch limits the output current to the maximum value. The heat generated by the power dissipation of the switch continuously limiting the current may exceed the package and PCB's ability to cool the device and the switch will shut down and signal a fault condition. Please see the Fault Output description in the previous page for more details on the FAULT/ output. After the switch

shuts down, and cools, it will re-start itself if the Enable signal retains true (high on the ENABLE parts, low on the ENABLE/ parts).

In Figure 2, die temperature is plotted against I_{OUT} assuming a constant ambient temperature of 85°C. The plot also assumes the maximum specified switch resistance at high temperature.

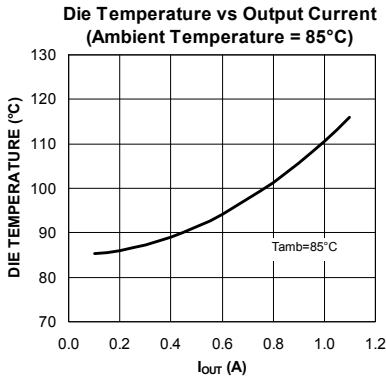

Figure 2. Die Temperature vs. I_{OUT}

Setting I_{LIMIT}

The current limit of the MIC2097 and MIC2099 parts are user programmable and controlled by a resistor connected between the I_{LIMIT} pin and Ground. The value of the current limit resistor is determined by the following equations:

$$I_{LIMIT} = \frac{\text{CurrentLimitFactor}(\text{CLF})}{R_{LIMIT}} \quad \text{Eq. 4}$$

or

$$R_{LIMIT} = \frac{\text{CurrentLimitFactor}(\text{CLF})}{I_{LIMIT}} \quad \text{Eq. 5}$$

The Current-Limit Factor (CLF) is a number that is characteristic to the MIC2097/9 switches. The CLF is a product of the current-setting resistor value, and the desired current-limit value. Please note that the CLF varies with the current output current, so caution is necessary to use the correct CLF value for the current that you intend to use the part at. For example: If one wishes to set a I_{LIMIT} = 1.1A, looking in the electrical specifications we will find CLF at I_{LIMIT} = 1.1 A, as noted in Table 1.

Min.	Typ.	Max.	Units
175	215	263	V

Table 1. CLF at I_{LIMIT} = 1.1A

For the sake of this example, the typical value of CLF at an I_{OUT} of 1.1A is 215V. Applying Equation 5:

$$R_{LIMIT}(\Omega) = \frac{215V}{1.1A} = 195\Omega \quad \text{Eq. 6}$$

Choose R_{LIMIT} = 196Ω (the closest standard 1% value) Designers should be aware that variations in the measured I_{LIMIT} for a given R_{LIMIT} resistor, will occur because of small differences between individual ICs (inherent in silicon processing) resulting in a spread of I_{LIMIT} values. In the example above we used the typical value of CLF to calculate R_{LIMIT}. We can determine I_{LIMIT}'s spread by using the minimum and maximum values of CLF and the calculated value of R_{LIMIT}:

$$I_{LIMIT_MIN} = \frac{175V}{196\Omega} = 0.89A \quad \text{Eq. 7}$$

$$I_{LIMIT_MAX} = \frac{263V}{196\Omega} = 1.34A \quad \text{Eq. 8}$$

Giving us a maximum I_{LIMIT} variation of:

I _{LIMIT_MIN}	I _{LIMIT_TYP}	I _{LIMIT_MAX}
0.89A (-19%)	1.1A	1.34A (+22%)

For convenience, Table 2 lists the resistance values for the R_{SET} pin, for various current limit values.

Nominal I _{LIMIT}	R _{LIMIT}	I _{LIMIT_MIN}	I _{LIMIT_MAX}
0.1A	1920	0.063	0.137
0.2A	1000	0.138	0.263
0.3A	672	0.211	0.391
0.4A	508	0.288	0.517
0.5A	412	0.369	0.638
0.6A	344	0.448	0.764
0.7A	298	0.533	0.884
0.8A	263	0.620	1.002
0.9A	235	0.709	1.118
1.0A	213	0.801	1.233
1.1A	195	0.895	1.346

Table 2. MIC2097 and MIC2099 R_{LIMIT} Table

I_{LIMIT} vs. I_{OUT} Measured

When in current limit, the switches are designed to act as a constant-current source to the load. As the load tries to pull more than the maximum current, V_{OUT} drops and the input-to-output voltage differential increases. As the $(V_{IN} - V_{OUT})$ voltage differential increases, the IC internal temperature also increases. To limit the IC's power dissipation, the current limit is reduced as a function of output voltage.

This folding back of I_{LIMIT} can be generalized by plotting I_{LIMIT} as a function of V_{OUT} , as shown in Figures 3 and 4. The slope of V_{OUT} between $I_{OUT} = 0V$ and $I_{OUT} = I_{LIMIT}$ (where I_{LIMIT} is a normalized 1A) is determined by R_{ON} of the switch and I_{LIMIT} .

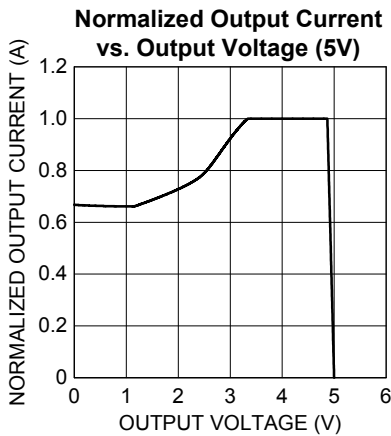

Figure 3. Normalized Output Current vs. Output Voltage

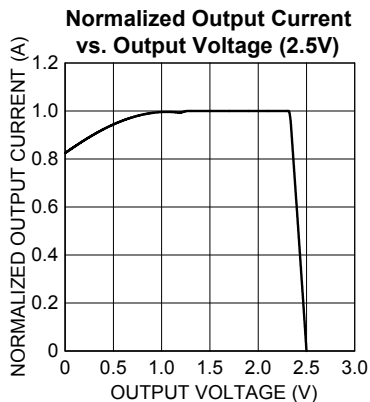

Figure 4. Normalized Output Current vs. Output Voltage

When measuring I_{OUT} it is important to remember voltage dependence, otherwise the measurement data may appear to indicate a problem when none really exists. This voltage dependence is illustrated in Figures 5 and 6.

In Figure 5, output current is measured as V_{OUT} is pulled below V_{IN} , with the test terminating when V_{OUT} is 1V below V_{IN} . Observe that once I_{LIMIT} is reached I_{OUT} remains constant throughout the remainder of the test. In Figure 6 this test is repeated but with $(V_{IN} - V_{OUT})$ is 4V.

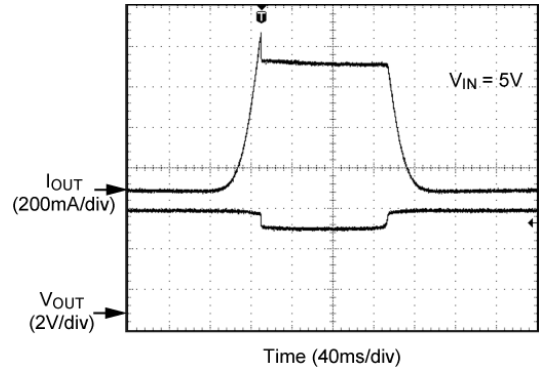

Figure 5. I_{OUT} in Current Limiting for $V_{OUT} = 4V$

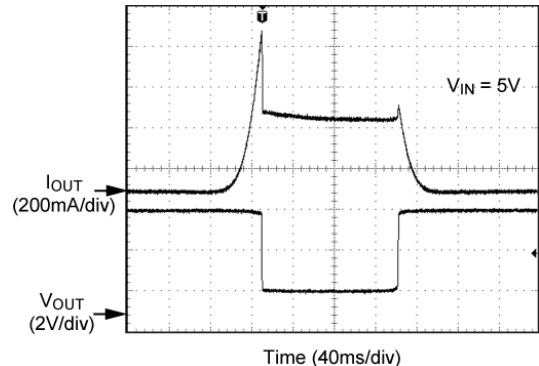

Figure 6. I_{OUT} in Current Limiting for $V_{OUT} = 1V$

Under Voltage Lock Out (UVLO)

The switches have an Under Voltage Lock Out (UVLO) feature that will shut down the switch in a reproducible manner when the input power supply voltage goes too low. The UVLO circuit disables the output until the supply voltage exceeds the UVLO threshold. Hysteresis in the UVLO circuit prevents noise and finite circuit impedance from causing chatter during turn-on and turn-off. While disabled by the UVLO circuit, the output switch (power MOSFET) is OFF and no circuit functions, such as FAULT/ or ENABLE, are considered to be valid or operative.

Typical Application Schematics

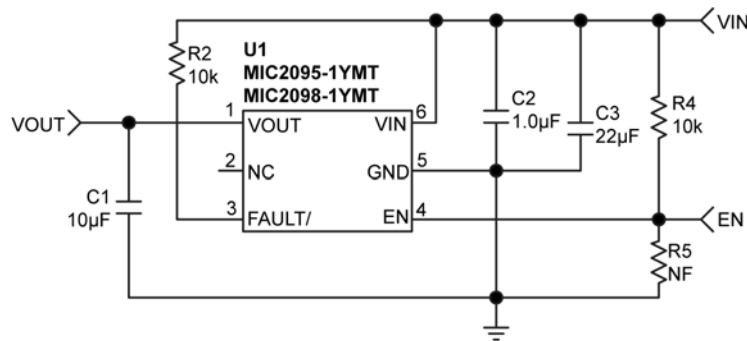

Figure 7. MIC2095-1 or MIC2098-1 Typical Schematic

Note: MIC2095-1 and MIC2098-1; R5=NF; EN pin uses R4 (pull-up resistor to V_{IN}) to enable the output without an external enable signal. MIC2095-2 and MIC2098-2; R4=NF; EN/ pin uses R5 (pull-down resistor to GND) to enable the output without an external enable signal.

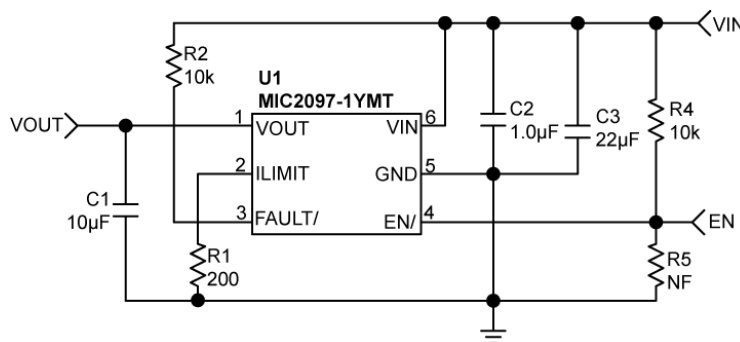

Figure 8. MIC2097-1 Typical Schematic

Note: MIC2097-1; R5=NF; EN pin uses R4 (pull-up resistor to V_{IN}) to enable the output without an external enable signal. MIC2097-2; R4=NF; EN/ pin uses R5 (pull-down resistor to GND) to enable the output without an external enable signal.

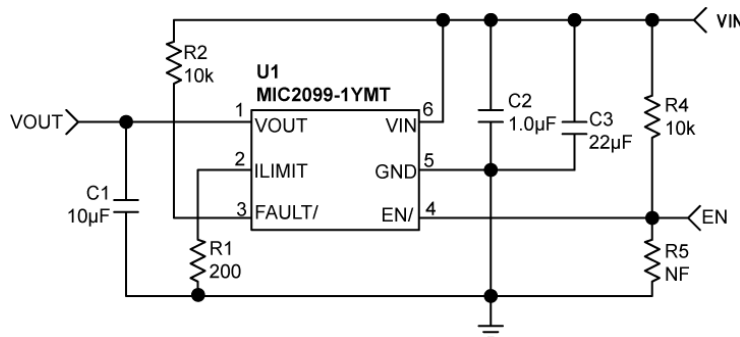

Figure 9. MIC2099-1 Schematic

Note: MIC2099-1; R5=NF; EN pin uses R4 (pull-up resistor to V_{IN}) to enable the output without an external enable signal. MIC2099-2; R4=NF; EN/ pin uses R5 (pull-down resistor to GND) to enable the output without an external enable signal.

Evaluation Board Schematic

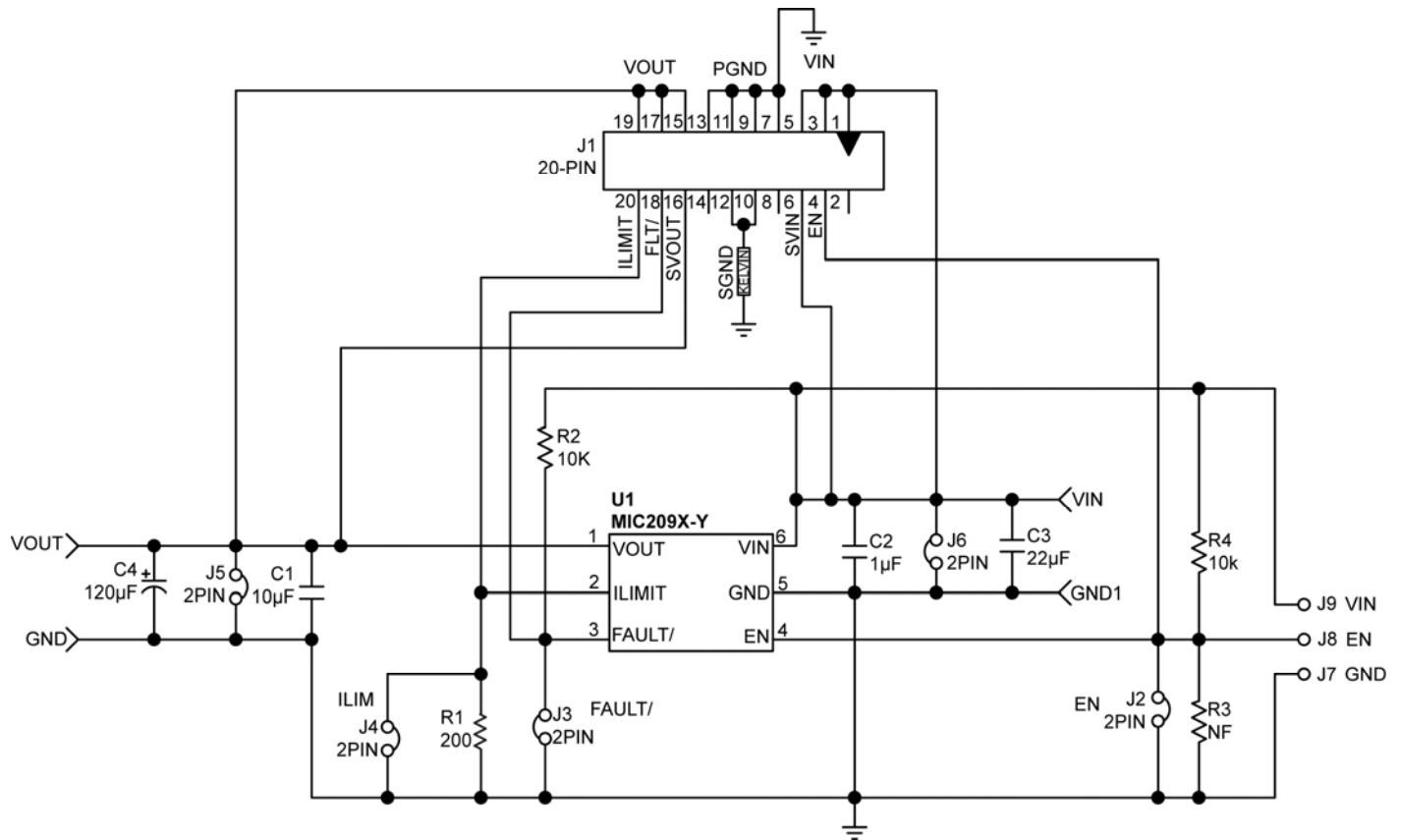

Figure 10. Schematic of MIC209X Evaluation Board

Notes:

1. Evaluation board is used for all parts.
2. Part numbering scheme is 209X-Y where X is the place holder for the last number (i.e. MIC2095, MIC2097, MIC2098 or MIC2099) and Y is the polarity of the enable signal (-1 indicates active high logic and -2 indicates active low logic).
3. MIC209X-1 EN pin only requires R4 (pull-up resistor to V_{IN}) to enable the output without an external enable signal.
4. MIC209X-2 EN/ pin only requires R3 (pull-down resistor-to-GND) to enable the output without an external enable signal.
5. R1 is NF (no fill) with the MIC2095 (fixed current limit).

MIC209x Bill of Materials

Item	Part Number	Manufacturer	Description	Qty.
C1	08056D106MAT2A	AVX ⁽¹⁾	Ceramic Capacitor, 10 μ F, 6.3V, X5R	1
C2	06033D105MAT2A	AVX ⁽¹⁾	Ceramic Capacitor, 1 μ F, 25V, X5R	1
C3	0805D226MAT2A	AVX ⁽¹⁾	Ceramic Capacitor, 22 μ F, 6.3V, X5R	1
C4			120 μ F (optional)	0
R1 ⁽⁴⁾	CRCW06032000FRT1	Vishay Dale ⁽²⁾	Resistor, 200 (0603 size), 1%	1
R2, R3, R4	CRCW06031002FRT1	Vishay Dale ⁽²⁾	Resistor, 10k (0603 size), 1%	3
U1	MIC2095-1YMT	Micrel, Inc. ⁽³⁾	Current-Limiting Power Distribution Switch – 0.5A Fixed Current Limit – Active High Enable	1
U1	MIC2095-2YMT	Micrel, Inc. ⁽³⁾	Current-Limiting Power Distribution Switch – 0.5A Fixed Current Limit – Active Low Enable	0
U1	MIC2097-1YMT	Micrel, Inc. ⁽³⁾	Current-Limiting Power Distribution Switch – Adjustable Current Limit with Kickstart – Active High Enable	0
U1	MIC2097-2YMT	Micrel, Inc. ⁽³⁾	Current-Limiting Power Distribution Switch – Adjustable Current Limit with Kickstart – Active Low Enable	0
U1	MIC2098-1YMT	Micrel, Inc. ⁽³⁾	Current-Limiting Power Distribution Switch – 0.9A Fixed Current Limit – Active High Enable	0
U1	MIC2098-2YMT	Micrel, Inc. ⁽³⁾	Current-Limiting Power Distribution Switch – 0.9A Fixed Current Limit – Active Low Enable	0
U1	MIC2099-1YMT	Micrel, Inc. ⁽³⁾	Current-Limiting Power Distribution Switch – Adjustable Current Limit – Active High Enable	0
U1	MIC2099-2YMT	Micrel, Inc. ⁽³⁾	Current-Limiting Power Distribution Switch – Adjustable Current Limit – Active Low Enable	0

Notes:

1. AVX: www.avx.com.
2. Vishay: www.vishay.com.
3. Micrel, Inc.: www.micrel.com.
4. May be omitted when used with the MIC2095 or MIC2098 (fixed current limit).

PCB Layout Recommendations

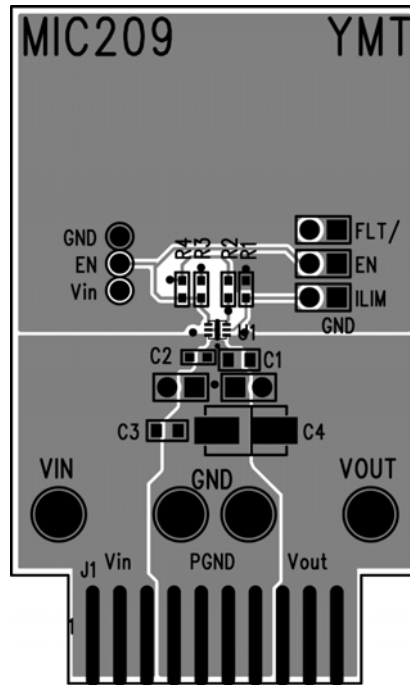

Figure 11. MIC209X Evaluation Board Top Layer

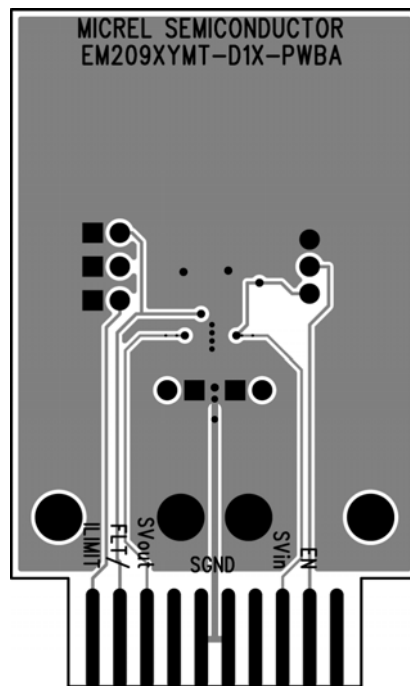
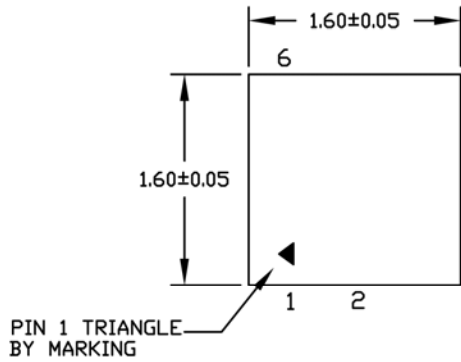
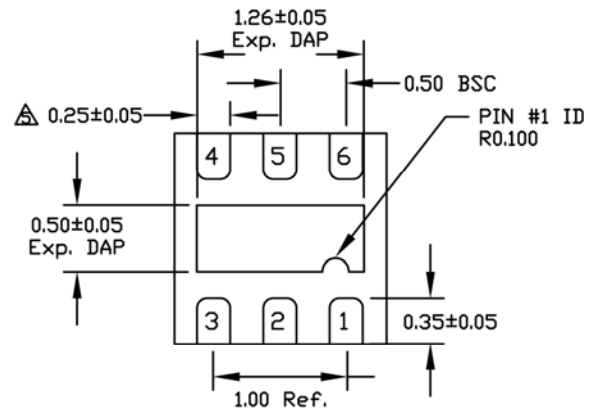

Figure 12. MIC209X Evaluation Board Bottom Layer

Package Information



TOP VIEW



BOTTOM VIEW

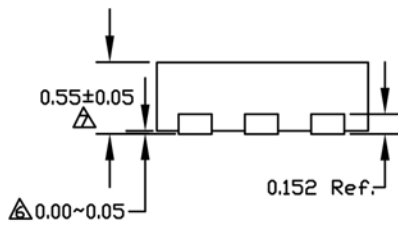

SIDE VIEW

NOTE:

1. ALL DIMENSIONS ARE IN MILLIMETERS.
 2. MAX. PACKAGE WARPAGE IS 0.05 mm.
 3. MAXIMUM ALLOWABLE BURRS IS 0.076 mm IN ALL DIRECTIONS.
 4. PIN #1 ID ON TOP WILL BE LASER/INK MARKED.
- DIMENSION APPLIES TO METALIZED TERMINAL AND IS MEASURED BETWEEN 0.20 AND 0.25 mm FROM TERMINAL TIP.
 APPLIED ONLY FOR TERMINALS.
 APPLIED FOR EXPOSED PAD AND TERMINALS.

6-Pin 1.6mm x 1.6mm TMLF (MT)

Recommended Landing Pattern

Recommended Land Pattern for MLF 1.6x1.6 6 Lead

LP # MLF1616D-6LD-LP-1
 All units are in mm
 Tolerance ± 0.05 if not noted

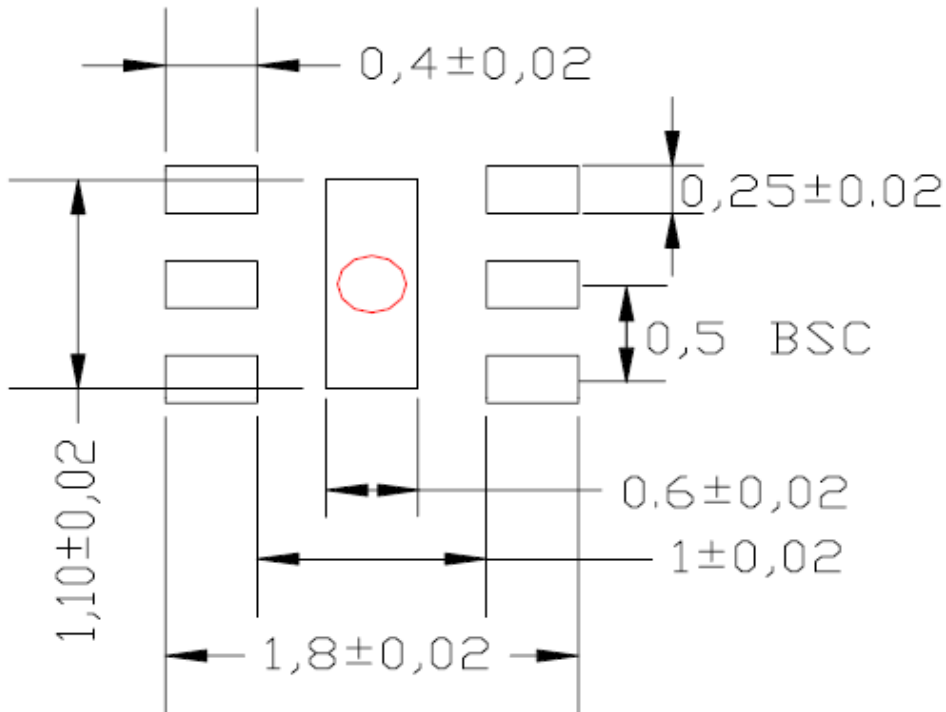

Red circle indicates Thermal Via. Size should be .300-.350 mm in diameter and it should be connected to GND plane for maximum thermal performance.

6-Pin 1.6mm x 1.6mm TMLF (MT)

MICREL, INC. 2180 FORTUNE DRIVE SAN JOSE, CA 95131 USA
 TEL +1 (408) 944-0800 FAX +1 (408) 474-1000 WEB <http://www.micrel.com>

Micrel makes no representations or warranties with respect to the accuracy or completeness of the information furnished in this data sheet. This information is not intended as a warranty and Micrel does not assume responsibility for its use. Micrel reserves the right to change circuitry, specifications and descriptions at any time without notice. No license, whether express, implied, arising by estoppel or otherwise, to any intellectual property rights is granted by this document. Except as provided in Micrel's terms and conditions of sale for such products, Micrel assumes no liability whatsoever, and Micrel disclaims any express or implied warranty relating to the sale and/or use of Micrel products including liability or warranties relating to fitness for a particular purpose, merchantability, or infringement of any patent, copyright or other intellectual property right.

Micrel Products are not designed or authorized for use as components in life support appliances, devices or systems where malfunction of a product can reasonably be expected to result in personal injury. Life support devices or systems are devices or systems that (a) are intended for surgical implant into the body or (b) support or sustain life, and whose failure to perform can be reasonably expected to result in a significant injury to the user. A Purchaser's use or sale of Micrel Products for use in life support appliances, devices or systems is a Purchaser's own risk and Purchaser agrees to fully indemnify Micrel for any damages resulting from such use or sale.

© 2010 Micrel, Incorporated.

Mouser Electronics

Authorized Distributor

Click to View Pricing, Inventory, Delivery & Lifecycle Information:

Micrel:

[MIC2097-1YMT TR](#) [MIC2099-1YMT TR](#) [MIC2098-2YMT TR](#) [MIC2099-2YMT TR](#) [MIC2098-1YMT TR](#)

Microchip:

[MIC2097-2YMT-TR](#) [MIC2097-1YMT-TR](#) [MIC2098-2YMT-TR](#) [MIC2095-2YMT-TR](#) [MIC2099-1YMT-TR](#) [MIC2099-2YMT-TR](#)