

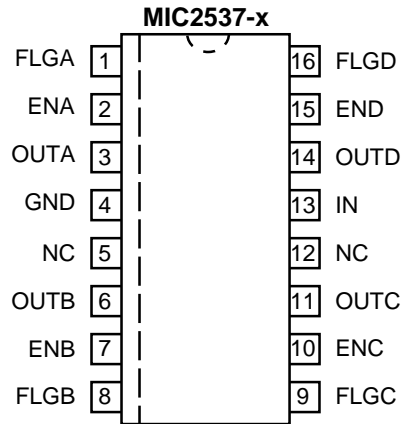

## Ordering Information

| Part Number | Enable      | Temperature Range | Package     |
|-------------|-------------|-------------------|-------------|
| MIC2537-1BM | Active High | -40°C to +85°C    | 16-Lead SOP |
| MIC2537-2BM | Active Low  | -40°C to +85°C    | 16-Lead SOP |

## Pin Configuration



**16-Lead SOP (M)**

## Pin Description

| Pin Number | Pin Name | Pin Function   |
|------------|----------|--|
| 1          | FLGA     | Flag A (Output): Channel A open-drain fault flag output. |
| 2          | ENA      | Enable A (Input): Channel A control input.               |
| 3          | OUTA     | Output A: Channel A switch output.                       |
| 4          | GND      | Ground: Supply return. Connect both leads to ground.     |
| 5, 12      | NC       | Not internally connected                                 |
| 6          | OUTB     | Output B: Channel B switch output.                       |
| 7          | ENB      | Enable B (Input): Channel B control input.               |
| 8          | FLGB     | Flag B (Output): Channel B open-drain fault flag output. |
| 9          | FLGC     | Flag C (Output): Channel C open-drain fault flag output. |
| 10         | ENC      | Enable C (Input): Channel C control input.               |
| 11         | OUTC     | Output C: Channel C switch output.                       |
| 13         | IN       | Positive Supply Input                                    |
| 14         | OUTD     | Output D: Channel D switch output.                       |
| 15         | END      | Enable D (Input): Channel D control input.               |
| 16         | FLGD     | Flag D (Output): Channel D open-drain fault flag output. |

**Absolute Maximum Ratings (Note 1)**

|                                     |                    |
|-------------------------------------|--------------------|
| Supply Voltage ( $V_{IN}$ )         | +6V                |
| Fault Flag Voltage ( $V_{FLG}$ )    | +6V                |
| Fault Flag Current ( $I_{FLG}$ )    | 25mA               |
| Output Voltage ( $V_{OUT}$ )        | +6V                |
| Output Current ( $I_{OUT}$ )        | Internally Limited |
| Control Input ( $V_{EN}$ )          | -0.3V to 12V       |
| Storage Temperature ( $T_S$ )       | -65°C to +150°C    |
| Lead Temperature (Soldering 5 sec.) | 260°C              |
| ESD Rating, Note 3                  | 2kV                |

**Operating Ratings (Note 2)**

|   |                |
|---|----------------|
| Supply Voltage ( $V_{IN}$ )                 | +3V to +5.5V   |
| Ambient Operating Temperature ( $T_A$ )     | -40°C to +85°C |
| Thermal Resistance<br>SOP ( $\theta_{JA}$ ) | 120°C/W        |

**Electrical Characteristics**

$V_{IN} = +5V$ ;  $T_A = 25^\circ C$ ; unless noted.

| Parameter                             | Condition   | Min | Typ  | Max | Units      |
|---------------------------------------|---|-----|------|-----|------------|
| Supply Current                        | <b>Note 4</b> , switch off, OUTA-D = open           |     | 0.75 | 5   | $\mu A$    |
|                                       | <b>Note 4</b> , all switches on, OUTA-D = open      |     | 70   | 100 | $\mu A$    |
| Enable Input Threshold                | low-to-high transition                              |     | 1.8  | 2.4 | V          |
|                                       | high-to-low transition, <b>Note 4</b>               | 0.8 | 1.6  |     | V          |
| Enable Input Current                  | $V_{EN} = V_{OH(min)} = 2.4V$                       |     | 0.01 | 1   | $\mu A$    |
|                                       | $V_{EN} = V_{OL(max)} = 0.8V$                       |     | 0.01 | 1   | $\mu A$    |
| Enable Input Capacitance              |   |     | 1    |     | pF         |
| Switch Resistance                     | single switch, 100mA load                           |     | 425  | 700 | m $\Omega$ |
| Output Turn-On Delay                  | $R_L = 50\Omega$ , $C_L = 1\mu F$ , <b>Note 5</b>   |     | 0.51 |     | ms         |
| Output Turn-On Rise Time              | $R_L = 50\Omega$ , $C_L = 1\mu F$ , <b>Note 5</b>   | 0.2 | 0.5  |     | ms         |
| Output Turnoff Delay                  | $R_L = 50\Omega$ , $C_L = 1\mu F$ , <b>Note 5</b>   |     | 150  | 300 | $\mu s$    |
| Output Turnoff Fall Time              | $R_L = 50\Omega$ , $C_L = 1\mu F$ , <b>Note 5</b>   |     | 148  | 300 | $\mu s$    |
| Output Leakage Current                | each output (switch off)                            |     | 1    | 10  | $\mu A$    |
| Current Limit Threshold               | ramped load applied to enable output, <b>Note 6</b> |     | 300  | 500 | mA         |
| Continuous Load Current               | each output, FLG not active                         | 100 |      |     | mA         |
| Short Circuit Current Limit           | each output (enabled into load), $V_{OUT} = 4.0V$   | 150 | 250  | 400 | mA         |
| Overtemperature Shutdown<br>Threshold | $T_J$ increasing                                    |     | 135  |     | $^\circ C$ |
|                                       | $T_J$ decreasing                                    |     | 125  |     | $^\circ C$ |
| Error Flag Output Resistance          | $V_{IN} = 5V$ , $I_L = 10mA$                        |     | 10   |     | $\Omega$   |
|                                       | $V_{IN} = 3.3V$ , $I_L = 10mA$                      |     | 12   |     | $\Omega$   |
| Error Flag Off Current                | $V_{FLAG} = 5V$                                     |     | 0.01 | 1   | $\mu A$    |

**Note 1.** Exceeding the absolute maximum rating may damage the device.

**Note 2.** The device is not guaranteed to function outside its operating rating.

**Note 3.** Devices are ESD sensitive. Handling precautions recommended. Human body model, 1.5k $\Omega$  in series with 100pF.

**Note 4.** Off is  $\leq 0.8V$  and on is  $\geq 2.4V$  for the MIC2537-1. Off is  $\geq 2.4V$  and on is  $\leq 0.8V$  for the MIC2537-2. The enable input has approximately 200mV of hysteresis. See control threshold charts.

**Note 5.** See "Timing Diagrams."

**Note 6.** See "Functional Characteristics: Current-Limit Response" graph.

# Typical Characteristics

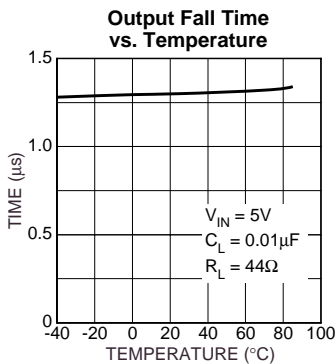
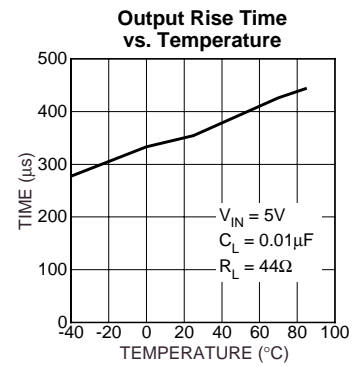
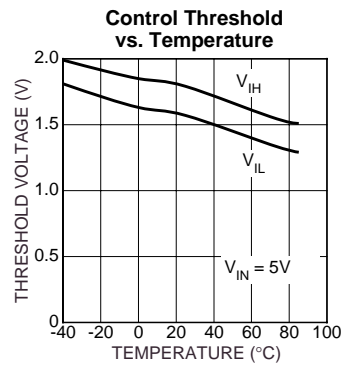
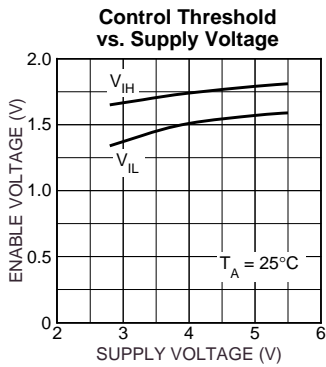
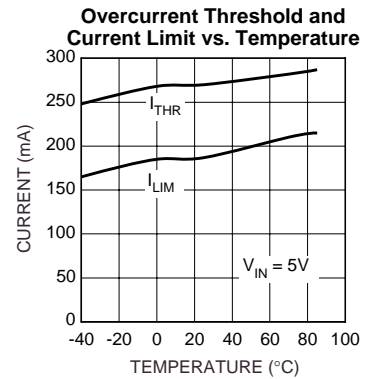
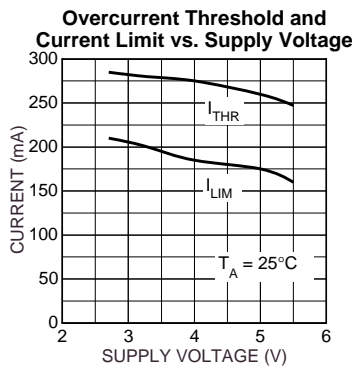
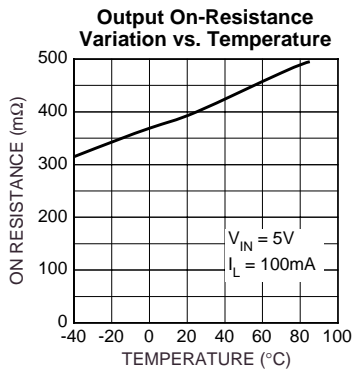
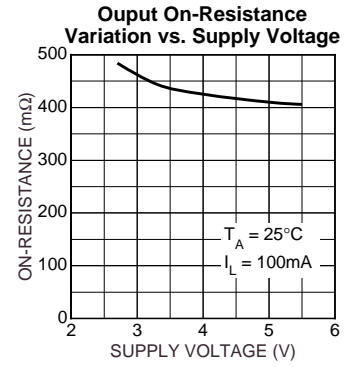
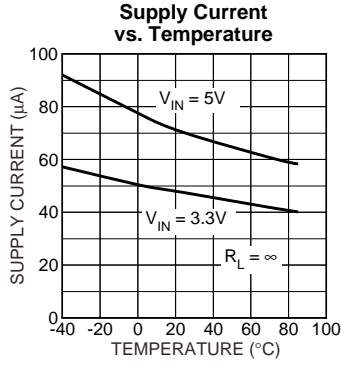
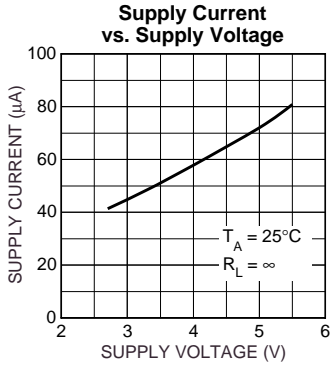

# Functional Characteristics

**Input Voltage Response**  
(Input Voltage Rising: MIC2537-2)

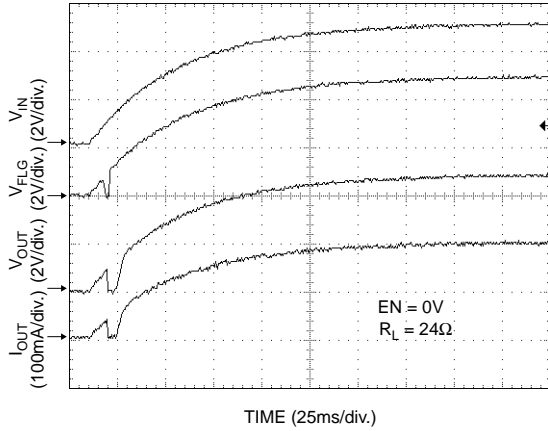

**Input Voltage Response**  
(Input Voltage Decreasing: MIC2537-2)

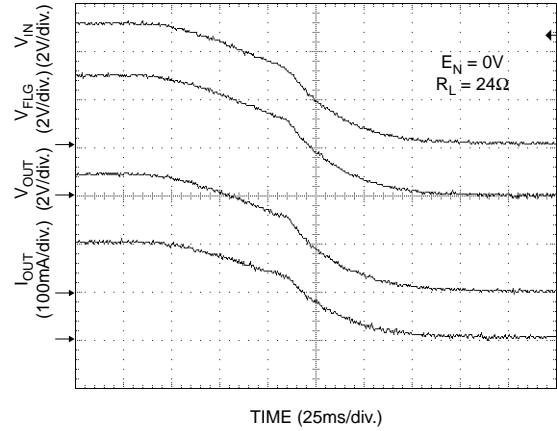

**Current Limit Transient Response**  
(Heavy Load Applied to Output: MIC2537-2)

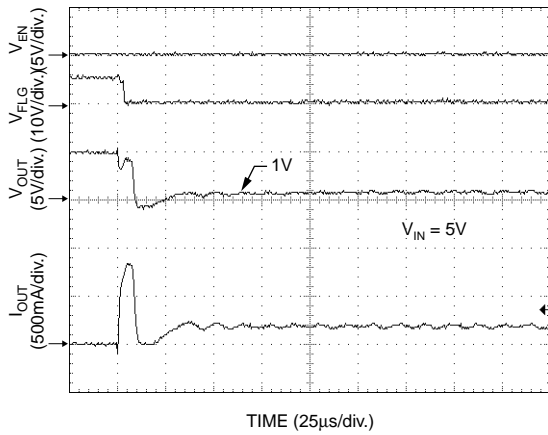

**Current Limit Response**  
(Ramped Load: MIC2537-2)

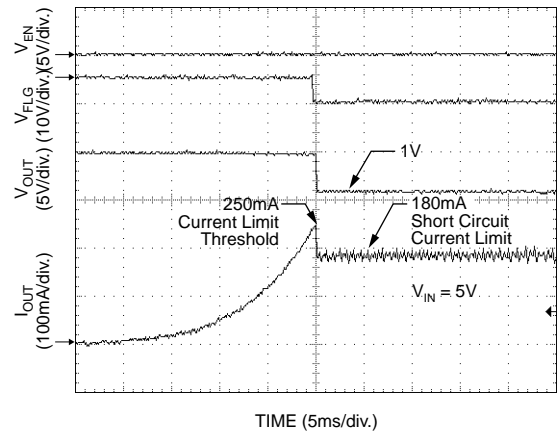

### Test Circuit

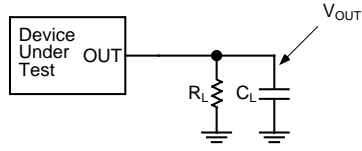

### Timing Diagrams

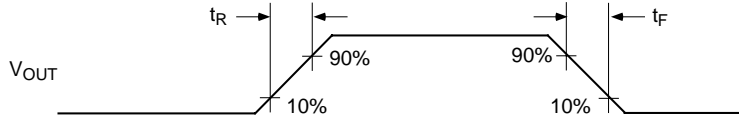

**Output Rise and Fall Times**

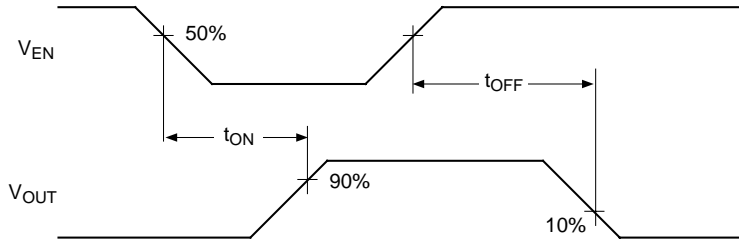

**Active-Low Switch Delay Times (MIC2537-2)**

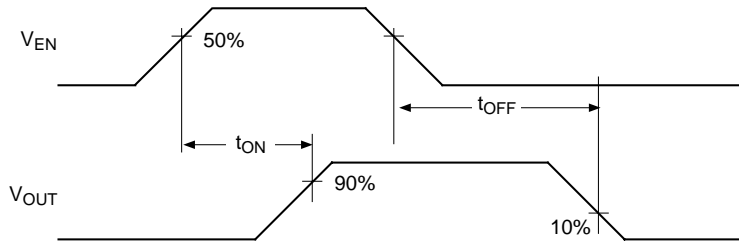

**Active-Low Switch Delay Times (MIC2537-1)**

# Functional Diagram

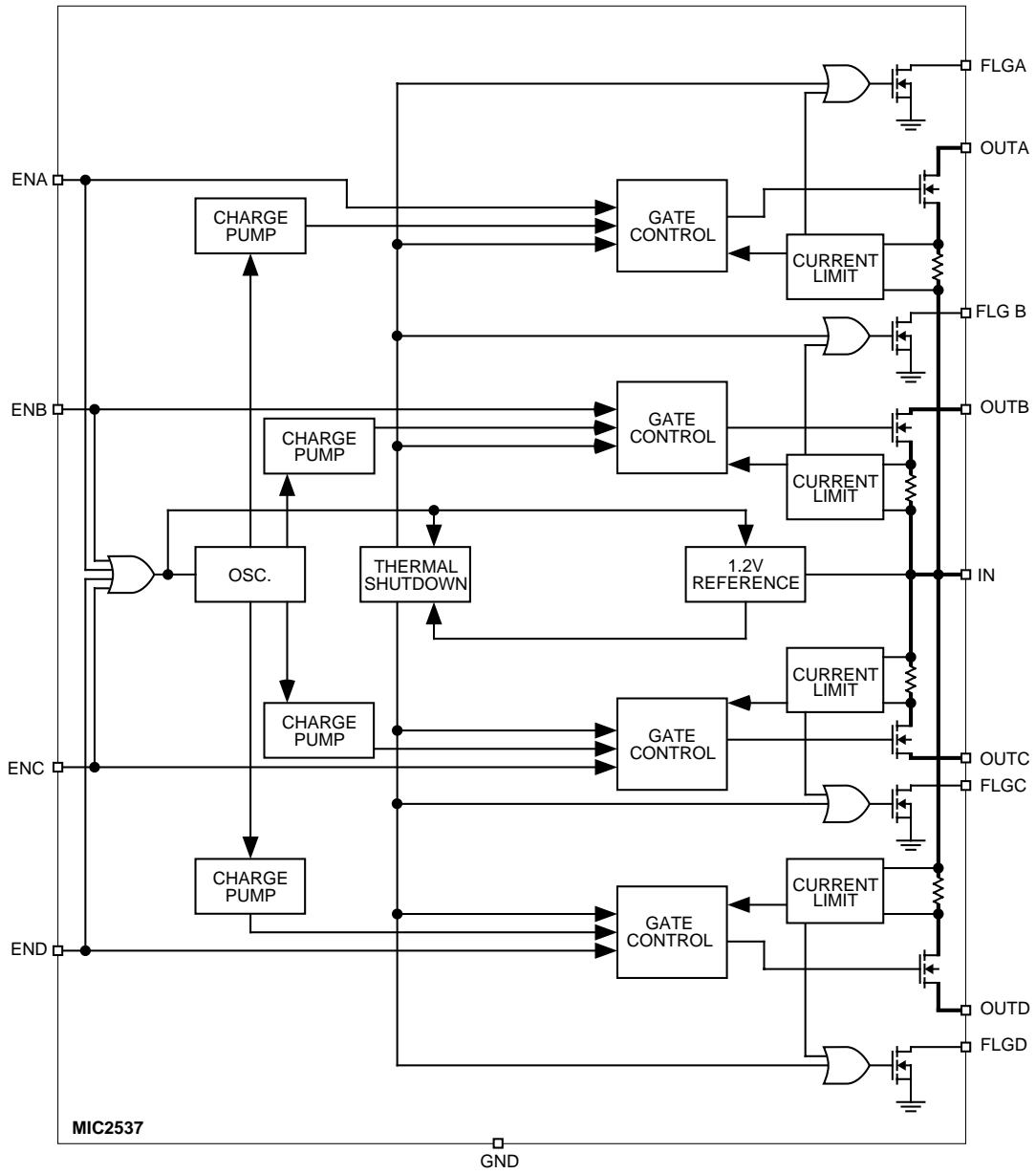

## Functional Description

The MIC2537-1 and MIC2537-2 are quad high-side switches with active-high and active-low enable inputs, respectively. Fault conditions turn off or inhibit turn-on of one or more of the output transistors, depending upon the type of fault, and activate the open-drain error flag transistors making them sink current to ground.

### Input and Output

IN (input) is the power supply connection to the logic circuitry and the drain of each output MOSFET. OUTx (output) is the source of each respective MOSFET. In a typical circuit, current flows through the switch from IN to OUTx toward the load. If  $V_{OUT}$  is greater than  $V_{IN}$ , current will flow from OUT to IN since the MOSFET is bidirectional when on.

The output MOSFET and driver circuitry are also designed to allow the MOSFET source to be externally forced to a higher voltage than the drain ( $V_{OUTx} > V_{IN}$ ) when the output is off. In this situation, the MIC2537 prevents reverse current flow.

### Thermal Shutdown

Thermal shutdown shuts off the affected output MOSFET and signals the corresponding fault flags if the die temperature exceeds 135°C. 10°C of hysteresis prevents the switch from turning on until the die temperature drops to 125°C. Overtemperature detection functions only when at least one switch is enabled.

### Current-Limit Induced Thermal Shutdown

Internal circuitry increases the output MOSFET on-resistance until the series combination of the MOSFET on-resistance and the load impedance limits output current to approximately 200mA. The resulting increase in power dissipation may cause the shorted channel to go into thermal shutdown. In addition, even though individual channels are thermally isolated, it is possible they may shut down when an adjacent channel is shorted. When this is undesirable, shutdown of the channels not shorted can be avoided by externally responding to the fault and disabling the current limited channel before the shutdown temperature is reached. The delay between the flag indication of a current limit fault and thermal shutdown will vary with ambient temperature, board layout, and load impedance, but is typically several seconds. The USB controller must therefore recognize a fault and disable the appropriate channel within this time.

## Current Sensing and Limiting

The current-limit threshold is preset internally. The preset level prevents damage to the output MOSFET and external load but allows a minimum current of 0.15A through the output MOSFET of each channel.

The current-limit circuit senses a portion of the output FET switch current. The current sense resistor shown in the block diagram is virtual and has no voltage drop. The reaction to an overcurrent condition varies with the following three scenarios:

### Switch Enabled into Short Circuit

If a switch is powered on or enabled into an excessive load or short circuit, the switch immediately goes into a constant-current mode, slowly increasing the output voltage. The fault flag goes low until the load is reduced.

### Short Circuit Applied to Output

When a heavy load or short circuit is applied to an enabled switch, a large transient current may flow until the current-limit circuitry responds. Once this occurs, the device limits current to less than the short circuit current-limit specification. See the "Functional Characteristics: Current-Limit Transient Response" graph for details.

### Current-Limit Response

The MIC2537 current-limit profile exhibits a small foldback effect of approximately 100mA. Once this current-limit threshold is exceeded the device enters constant-current mode. This constant current is specified as the short-circuit current limit in the "Electrical Characteristics" table. It is important to note that the MIC2537 will deliver load current up to the current-limit threshold. See the "Functional Characteristics: Current-Limit Response" graph for details.

### Fault Flag

FLGx is an open-drain N-channel MOSFET output. Fault flags are active (low) for current limit or thermal shutdown. Each flag output MOSFET is capable of sinking a 10mA load to approximately 200mV above ground. Several FLGx pins may be wired-NOR connected to a common pull-up resistor.



## Applications Information

### Supply Filtering

A 0.1 $\mu$ F to 1 $\mu$ F bypass capacitor from IN to GND, located at the device, is strongly recommended to control supply transients. Without a bypass capacitor, an output short may cause sufficient ringing on the input (from supply lead inductance) to damage internal control circuitry.

*Input or output transients must not exceed the absolute maximum supply voltage ( $V_{IN(max)} = 6V$ ) even for a short duration.*

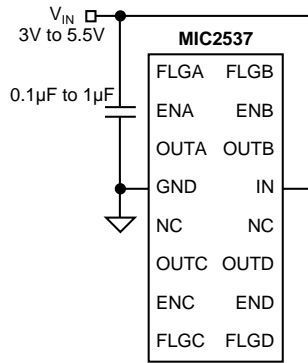

**Figure 1. Supply Bypassing**

### Enable Input

EN must be driven logic high or logic low for a clearly defined input. Floating the input may cause unpredictable operation. EN should not be allowed to go negative with respect to GND.

### Soft Start

The MIC2537 presents a high impedance when off and slowly becomes a low impedance as it turns on. This reduces inrush current and related voltage drop that results from charging a capacitive load, satisfying the USB voltage droop requirements.

### Transient Overcurrent Fault-Flag Filter

When the MIC2537 is enabled, large values of capacitance at the output of the device will cause inrush currents to flow that exceed the short circuit current-limit threshold of the device and cause the flag to activate. The duration of this time depends on the size of the output capacitance. See “Functional Characteristics: Switch Turn-On and Turnoff Characteristics” for details. During the charging time, the device enters into constant-current mode and the flag is activated. As the capacitance is charged the current decreases below the short circuit current-limit threshold and the flag will be deasserted.

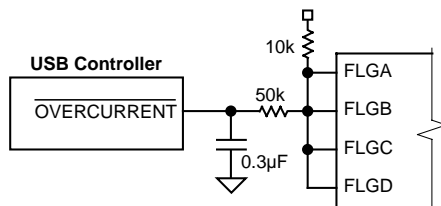

**Figure 2. Transient Filter**

In USB applications it is required that output bulk capacitance shown in “Typical Application” is utilized to meet transient regulation requirements during hot-plug events. When the MIC2537 is enabled, the flag will go active for about 5ms depending on output capacitance. Additionally, during hot-plug events, inrush currents may cause the flag to go active for approximately 30 $\mu$ s. If these “false” overcurrent indications are a system problem, they can be masked by an RC filter on the flag output (see Figure 2). Alternatively, a 15ms debounce routine may be programmed into the USB logic controller to eliminate the need for an RC filter.

### Bus-Powered Hub Port Switching

The USB Specification requires that bus-powered hubs implement port switching on either a ganged or individual basis. The specific implementation must be reported via the Hub Descriptor Status Register. Individual port switching has advantages in that a fault on one port will not prevent the other ports from operating correctly. In addition, a soft-start circuit must be included in order to reduce inrush currents when the switch is enabled. To meet this requirement, the MIC2537 has been designed to slowly ramp its output.

### Suspend Current

For hubs, *Universal Serial Bus Specification Revision 1.1* section 7.2.3, stipulates that the maximum suspend current for a configured hub is 2.5mA. This number is derived by allocating 500 $\mu$ A for up to four downstream ports plus 500 $\mu$ A for the hub’s internal functions. A nonconfigured hub is considered a low-power device and cannot consume more than 500 $\mu$ A. In a nonconfigured state all downstream devices will be switched off. In most cases, a nonconfigured hub is not a practical state for the system. Therefore, the 2.5mA specification is the applicable target specification for the suspend state. In a bus-powered hub with less than 4 ports, the hub may use the additional current for internal functions.

The 500 $\mu$ A worst case suspend current must be further divided among the data port termination resistors and internal functions. The termination resistors will consume  $3.6V \div (16.5K\Omega - 5\%) = 230\mu A$ . This leaves only 270 $\mu$ A for internal functions. Assuming 100 $\mu$ A as the maximum USB controller suspend current, 170 $\mu$ A remains for the rest of the system. The MIC2537 will consume 100 $\mu$ A maximum, leaving a margin of 70 $\mu$ A.

**USB Voltage Regulation**

USB specifications require a minimum downstream voltage supply of 4.40V from a bus-powered hub port (See *Application Note 17* for details). The USB specification allows for a 100mV drop across the hub, leaving 250mV for PCB, upstream cable, and connector resistance. Therefore, the on-resistance of the switch for each port, not including PCB resistance, must be about  $100\text{mV} \div 100\text{mA} = 1\Omega$ . The MIC2537 has a maximum on-resistance of  $700\text{m}\Omega$ , which easily satisfies this requirement.

**Overcurrent Indication**

The USB Specification does not require bus-powered hubs to report overcurrent conditions to the host since the hub is already current-limited at the upstream port. However, if it is desired to report overcurrent, the Hub Descriptor Status Register must be programmed to indicate this. The MIC2537 provides a flag output for this application.

# Package Information

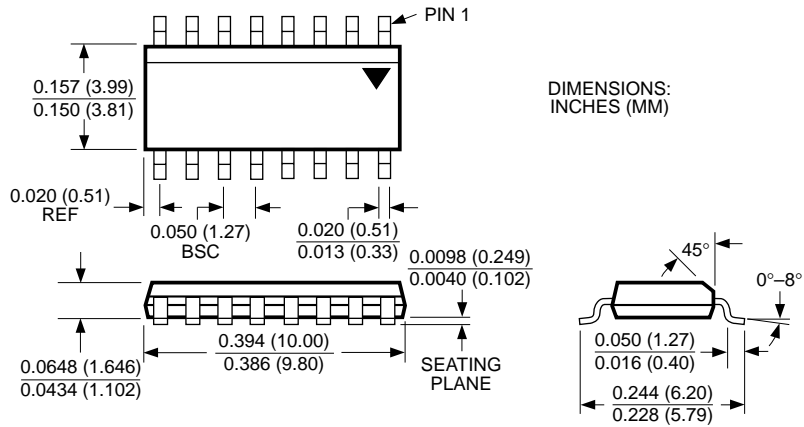

**16-Lead SOP (M)**

---

**MICREL INC. 1849 FORTUNE DRIVE SAN JOSE, CA 95131 USA**

TEL + 1 (408) 944-0800 FAX + 1 (408) 944-0970 WEB <http://www.micrel.com>

This information is believed to be accurate and reliable, however no responsibility is assumed by Micrel for its use nor for any infringement of patents or other rights of third parties resulting from its use. No license is granted by implication or otherwise under any patent or patent right of Micrel Inc.

© 1999 Micrel Incorporated

# Mouser Electronics

Authorized Distributor

Click to View Pricing, Inventory, Delivery & Lifecycle Information:

[Micrel:](#)

[MIC2537-2YM TR](#)

[Microchip:](#)

[MIC2537-1YM](#) [MIC2537-2YM](#) [MIC2537-2YM-TR](#) [MIC2537-1YM-TR](#)