

1M-Series

Miniature Rockers & Paddles

PRODUCT WEBPAGE

request sample, configure part

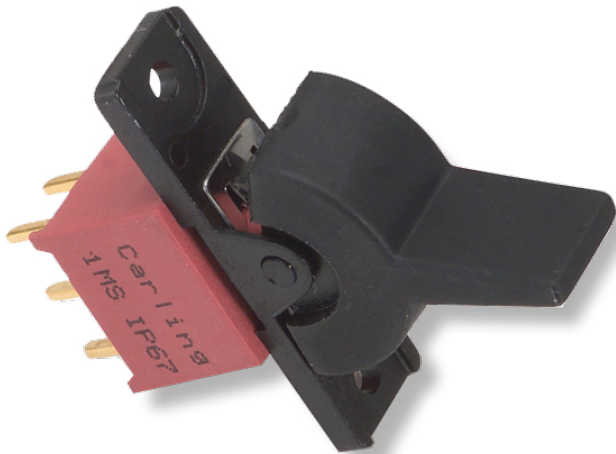
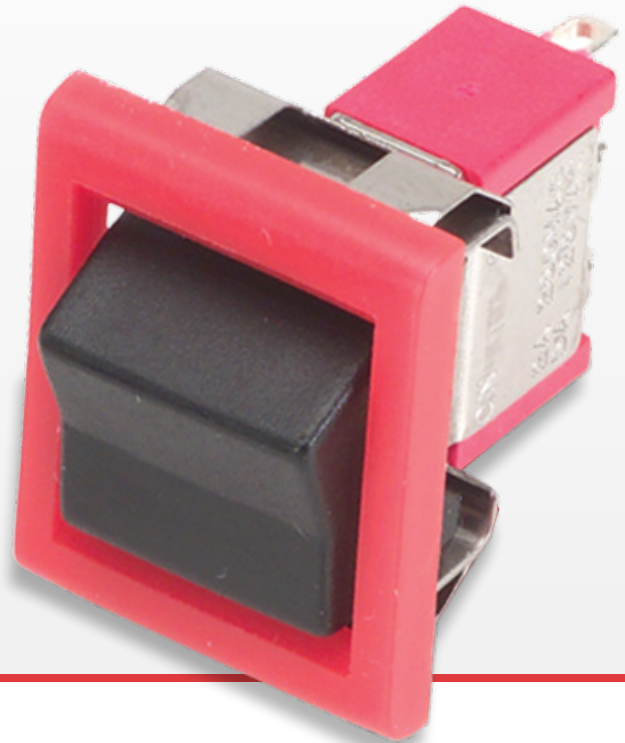

The 1M family of miniature rocker & paddle switches is composed of two switch series; the 1M1-Series miniature rocker and paddle switch, and the 1MS-Series sealed miniature rocker and paddle switch. Both products feature PC mounting and offer a variety of ratings, circuits, contact materials, terminal platings, rocker and paddle actuator styles and colors.

1-3 **.4-5** **125,250** **28**
Poles Amps VAC VDC

Typical Applications

- Instrumentation
- Test Equipment
- Telecommunications
- Networking
- Handheld Appliances

Tech Specs

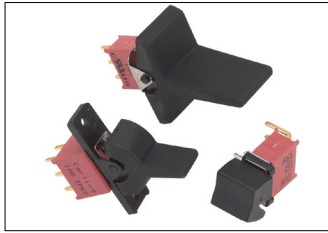

**IMS-Series
Sealed**
Miniature Rocker
& Rocker Switch

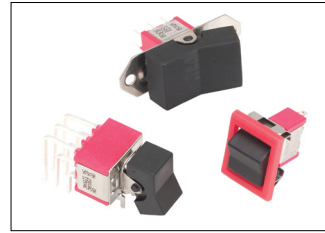

IMI-Series
Miniature Rocker
& Rocker Switch

Electrical

Contact Rating	refer to ordering scheme
Electrical Life	IMS-Series: 30,000 make & break cycles @ full load IMI-Series: 50,000 make & breakcycles @ full load
Contact Resistance	10 mΩ max. initial @ 2-4 VDC 100mA for both silver & gold plated contacts
Insulation Resistance	1000 MΩ min.
Dielectric Strength	1500 Volts RMS @ sea level

Physical

Operating Temperature	-30°C to +85°C
Index of Protection	IMS-Series: IP67
Solder Heat Resistance	MIL-STD-202, Method 210
Actuator Travel	25°

Material

Case	IMS-Series: Glass filled nylon 6/6, flame retardant, heat stabilized (UL 94V-0) IMI-Series: Diallyl phthalate (DAP) (UL 94V-0)
Rocker/Paddle	IMS-Series: Nylon, black standard, internal o-ring sealed IMI-Series: Nylon (UL 94V-0)
Bushing	IMS-Series: Glass filled nylon 6/6, flame retardant, heat stabilized (UL 94V-0) IMI-Series: Brass, nickel plated
Housing	IMS-Series: Spring Steel IMI-Series: Stainless Steel
Actuator Pivot & Mounting Bracket	IMS-Series: Nylon (UL 94V-0) IMI-Series: Stainless Steel
Actuator Pivot Retainer	IMS-Series: Stainless Steel
Switch Support	Brass, tin plated
Terminal Seal	Epoxy

Ordering Schemes

Sample Part Number

IMS - SP 1 - R6 / 2 M6 G E

Selection 1 2 3 4 5 6 7 8

1. SERIES

IMS Sealed Miniature Rocker Switch

2. POLES

SP Single pole - uses terminals 1, 2 & 3
DP Double pole uses terminals 1, 2, 3, 4, 5 & 6
3P Three pole uses terminals 1, 2, 3, 4, 5, 6, 7, 8 & 9

3. CIRCUIT

() - momentary
Position: **1** **2** **3**
 2-3, 5-6, 8-9 Connected Terminals 2-1, 5-4, 8-7

1	ON	NONE	ON
2	ON	NONE	(ON)
3	ON	OFF	ON
4	(ON)	OFF	(ON)
5	ON	OFF	(ON)
6*	ON	ON	ON
7*	(ON)	ON	(ON)
8*	ON	ON	(ON)
9*	OFF	ON	(ON)

*Center Position Connects 2-3, 5-4, 8-9

4. ACTUATOR STYLE

R1 Standard Rocker **R5** Large Rocker
R2 Standard Paddle **R6** Small Rocker
R3 Medium Rocker **R7** Medium Paddle
R4 Large Paddle

5. ACTUATOR COLOR

1 White **2** Black **3** Red
 Black is standard. Other colors available, consult factory.

6. TERMINATION

M1 Solder Lug	VS2 PC Mount, U bracket
M2 PCB	VS3 PC Mount, U bracket
M3 Quick Connect	VS4 PC Mount, U bracket
M51 Wire Wrap	VS5 PC Mount, U bracket
M52 Wire Wrap	VS21 Snap-In, U bracket
M53 Wire Wrap	VS31 Snap-In, U bracket
M54 Wire Wrap	VS41 Snap-In, U bracket
M6 PC Mount, 90° horizontal	VS51 Snap-In, U bracket
M7 PC Mount, 90° vertical	U2 Vertical Mount, 3-Pole
	U4 Snap-In, U bracket, 3-Pole

See dimensional specifications.

7. CONTACTS / TERMINALS

Contact Material	Terminal Plating	Rating	Approvals
G silver ¹	gold over silver 2A	5A 125VAC or 28VDC, 250VAC	us, IP67
K gold ^{2,5}	tin ⁴	0.4VA max 20V max (AC/DC)	IP67
P silver ^{1,6}	tin ⁴	5A 125VAC or 28VDC, 250VAC	us, IP67
R gold ²	gold ³	0.4VA max 20V max (AC/DC)	IP67

8. EPOXY SEAL

E Epoxy Seal **0** without Epoxy Seal

Notes:

- Tin option not available with M1 and M3 terminals.
- 1 Movable contact and terminal platings: silver over copper alloy
- 2 Movable contact platings: gold over nickel over copper alloy
- 3 Terminal platings: gold over nickel over copper alloy
- 4 Terminal platings: tin over copper alloy
- 5 Terminal contact platings: gold over nickel alloy
- 6 Terminal contact platings: silver over nickel alloy

[Configure Complete Part Number >](#)

[Browse Standard Parts >](#)

Sample Part Number

IMI - SP 1 - R8 / 2 - 2 M6 Q E

Selection 1 2 3 4 5 6 7 8 9

1. SERIES

IMI Miniature Rocker Switch

2. POLES

SP Single pole - uses terminals 1, 2 & 3
DP Double pole uses terminals 1, 2, 3, 4, 5 & 6
3P Three pole uses terminals 1, 2, 3, 4, 5, 6, 7, 8 & 9
4P Four pole uses terminals 1, 2, 3, 4, 5, 6, 7, 8, 9, 10, 11, 12

3. CIRCUIT

() - momentary
Position: **1** **2** **3**
 2-3, 5-6, 8-9, 11-12 Connected Terminals 2-1, 5-4, 8-7, 11-10

1	ON	NONE	ON
2	ON	NONE	(ON)
3	ON	OFF	ON
4	(ON)	OFF	(ON)
5	ON	OFF	(ON)
6 ¹	ON	ON	ON
7 ¹	(ON)	ON	(ON)
8 ¹	ON	ON	(ON)
9 ²	NONE	ON	(ON)

4. ACTUATOR STYLE

R1 Standard Rocker **R6** Rocker & frame
R2 Standard Paddle **R7** Paddle & frame
R3 Medium Rocker **R8** Rocker without frame
R4 Large Paddle **R9** Paddle without frame
R5 Large rocker

5. ACTUATOR COLOR / 6 FRAME COLOR

0 No Frame* **2** Black
1 White **3** Red
 Black is standard. Other colors available, consult factory.
 *Actuator style R8 or R9 only.

7. TERMINATION

M1 Solder Lug	VS3 PC Mount, U bracket
M2 PCB	VS4 PC Mount, U bracket
M3 Quick Connect	VS5 PC Mount, U bracket
M51 Wire Wrap	M61 Snap-In, U bracket, 90° horizontal
M52 Wire Wrap	M71 Snap-In, U bracket, 90° vertical
M53 Wire Wrap	VS21 Snap-In, U bracket
M54 Wire Wrap	VS31 Snap-In, U bracket
M6 PC Mount, 90° horizontal	VS41 Snap-In, U bracket
M7 PC Mount, 90° vertical	VS51 Snap-In, U bracket
VS2 PC Mount, U bracket	U4 Snap-In, U bracket, 3-Pole

See dimensional specifications.

8. CONTACTS / TERMINALS

Contact Material	Terminal Plating	Rating	Approvals
G silver ³	gold over silver 2A	5A 125VAC or 28VDC, 250VAC	
K gold ^{4,7}	tin ⁶	0.4VA max 20V max (AC/DC)	N/A
P silver ^{3,8}	tin ⁶	5A 125VAC or 28VDC, 2A 250VAC	
Q silver ³	silver ³	5A 125VAC or 28VDC, 2A 250VAC	
R gold ⁴	gold ⁵	0.4VA max 20V max (AC/DC)	N/A

9. EPOXY SEAL

E Epoxy Seal **0** without Epoxy Seal

Notes:

- Tin option not available with M1 and M3 terminals.
- 1 Double-Pole and Four-Pole only. Center position connects 2-3, 5-4, 8-9, 11-10
- 2 Double-Pole only
- 3 Movable contact and terminal platings: silver over copper alloy
- 4 Movable contact platings: gold over nickel over copper alloy
- 5 Terminal platings: gold over nickel over copper alloy
- 6 Terminal platings: tin over copper alloy
- 7 Terminal contact platings: gold over nickel alloy
- 8 Terminal contact platings: silver over nickel alloy

[Configure Complete Part Number >](#)

[Browse Standard Parts >](#)

Dimensional Specs

inches [millimeters]

Single Pole

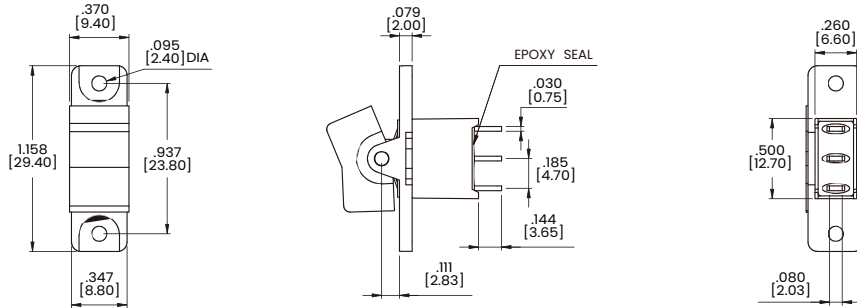

Double Pole

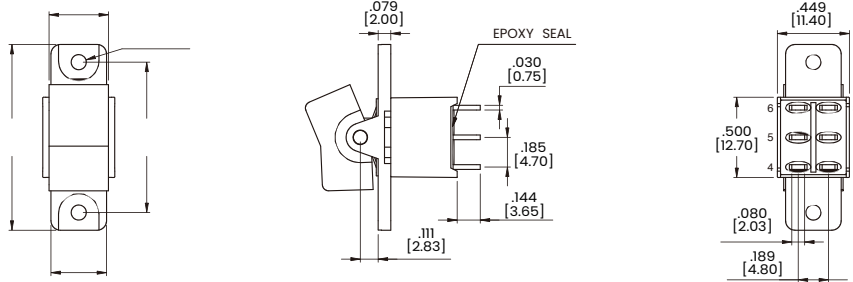

Three Pole

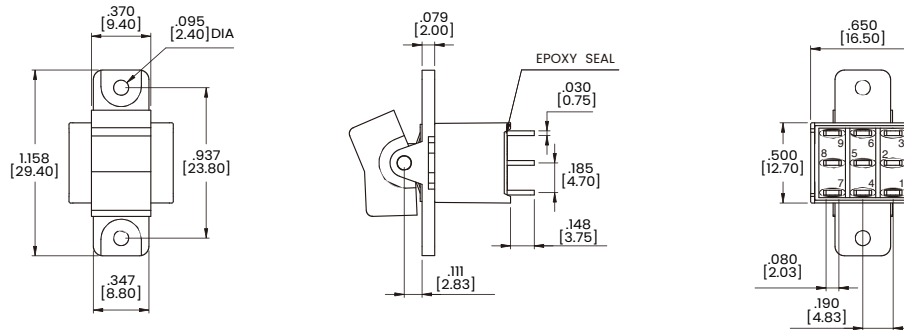

Actuator Options for Panel Rear Mount

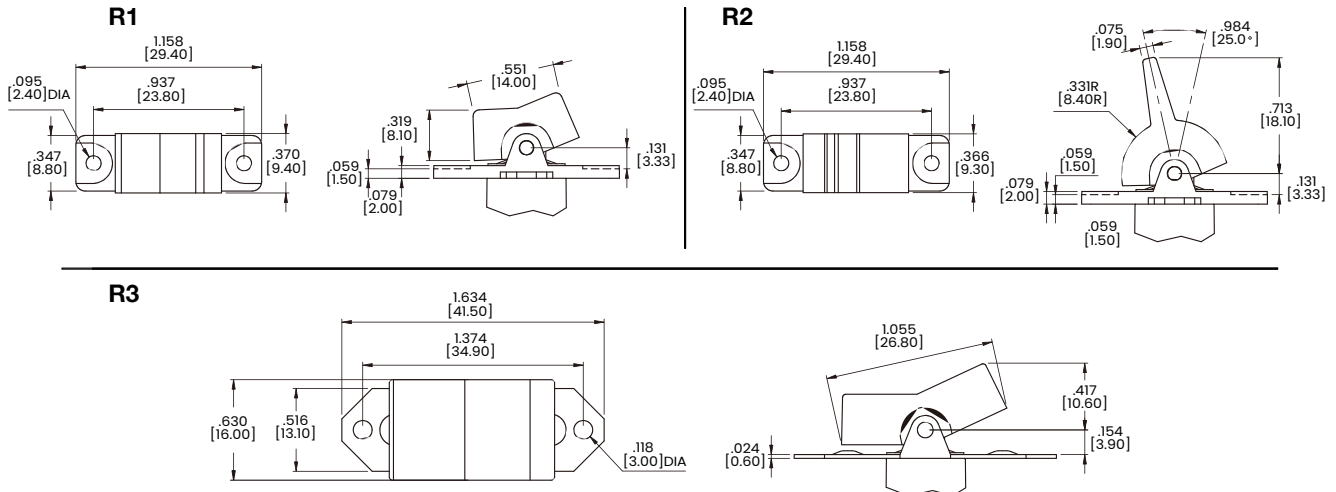

Dimensional Specs

inches [millimeters]

Actuator Options for Panel Rear Mount

R4

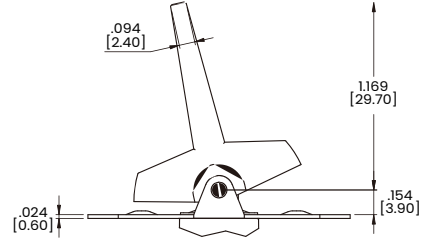
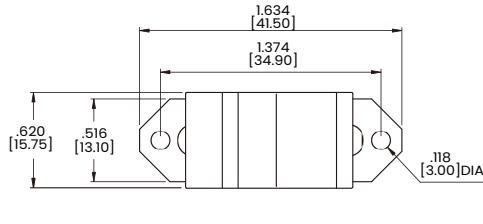

R5

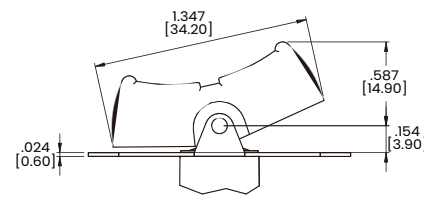
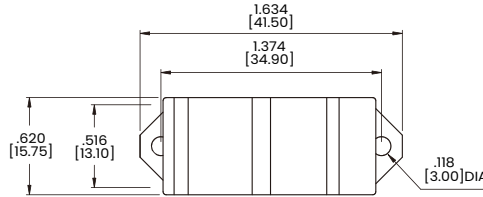

R6

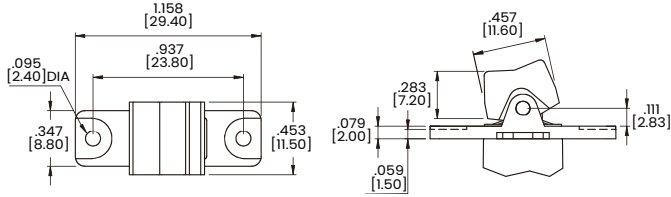

R7

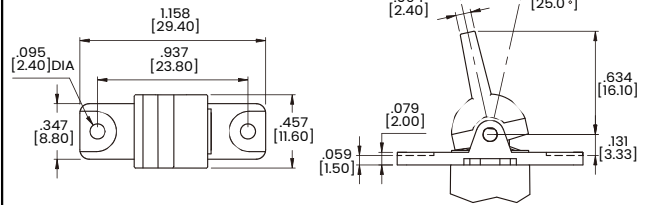

Actuator Options for PC Mount

R1

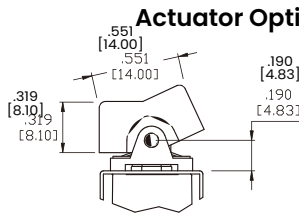

R2

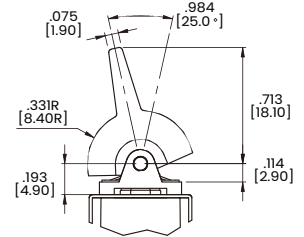

R3

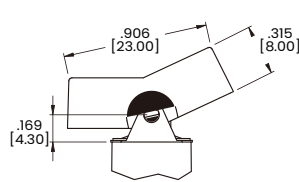
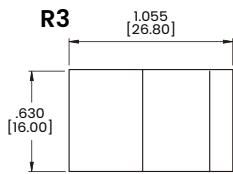

R4

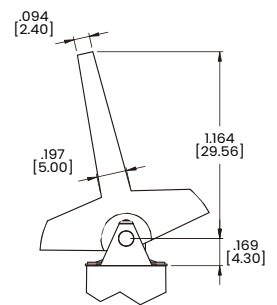
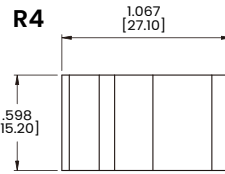

R5

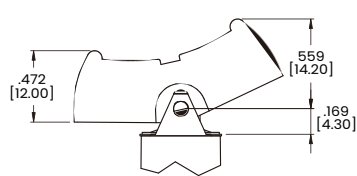
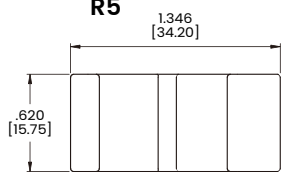

R6

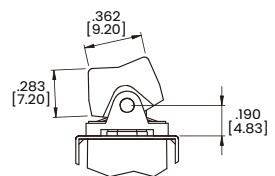
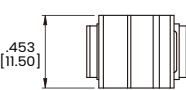

Dimensional Specs

inches [millimeters]

Actuator Options for PC Mount

R7

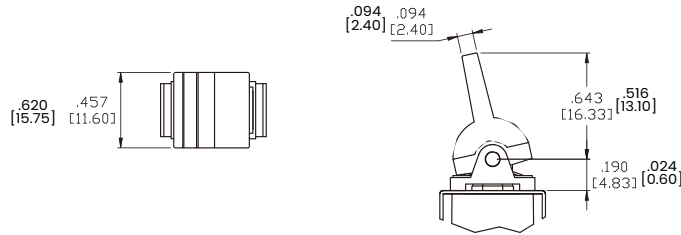

Termination Options

M1 Standard Solder Lug

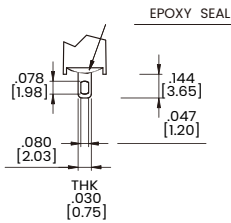

M2 PC Thru-Hole

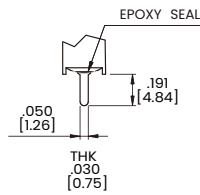

M3 Quick Connect

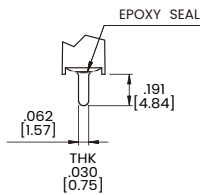

M5 Wire Wrap

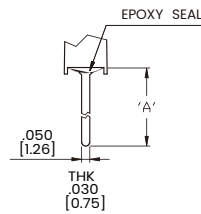

OPTION CODE	DIM.'A'
M5-1	.711 [18.05]
M5-2	.924 [23.48]
M5-3	.386 [9.80]
M5-4	1.022 [25.97]

M6 Single Pole

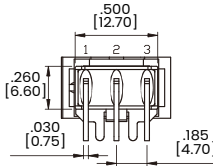
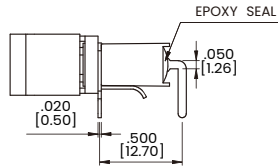
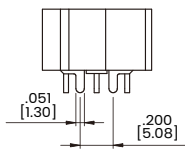

P.C.MOUNTING

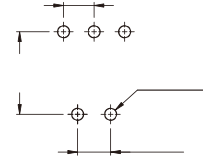

M6 Double Pole

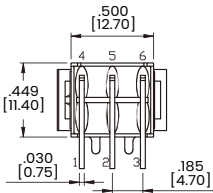
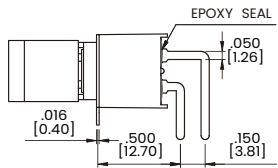
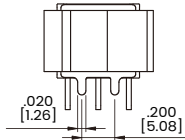

P.C.MOUNTING

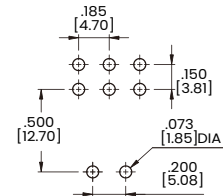

M6 Three Pole

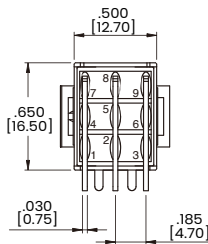
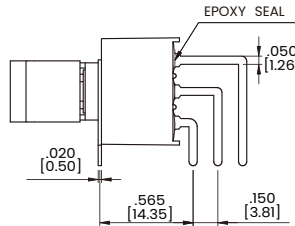
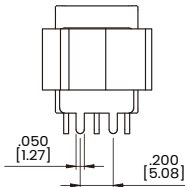

P.C.MOUNTING

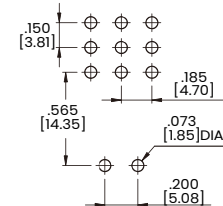

M7 Single Pole

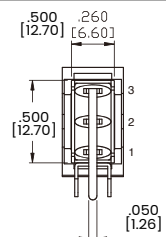
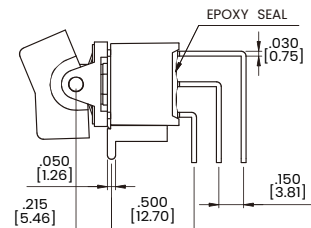
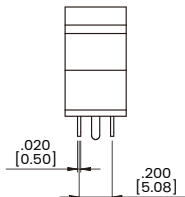

P.C.MOUNTING

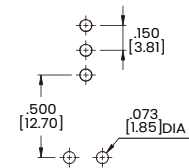

Dimensional Specs

inches [millimeters]

Termination Options

M7 Double Pole

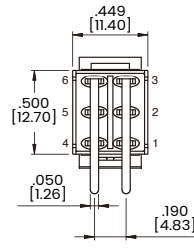
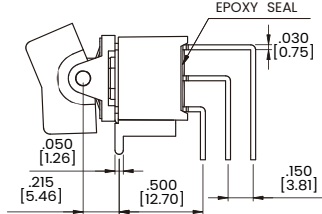
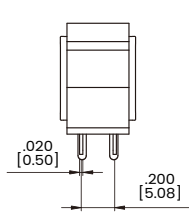

P.C.MOUNTING

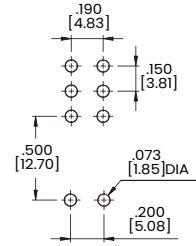

M7 Three Pole

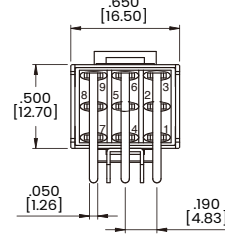
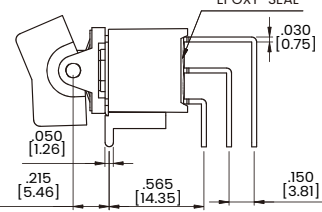
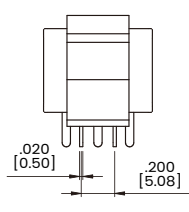

P.C.MOUNTING

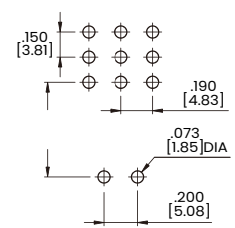

VS2-VS3 Single Pole

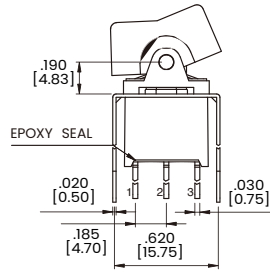
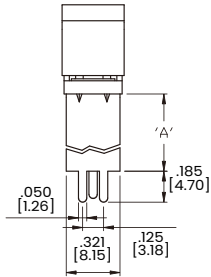

OPTION CODE	DIM.'A'
VS2	.461 [11.70]
VS3	.630 [16.00]

P.C.MOUNTING

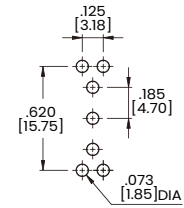

VS2-VS3 Double Pole

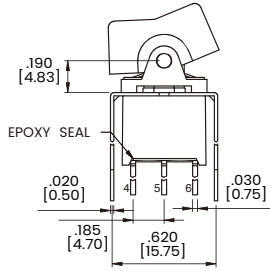
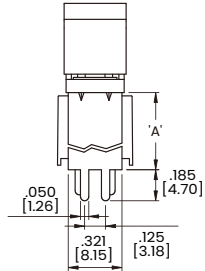

OPTION CODE	DIM.'A'
VS2	.461 [11.70]
VS3	.630 [16.00]

P.C.MOUNTING

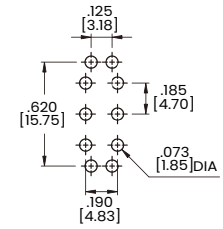

U2-VS3 Three Pole

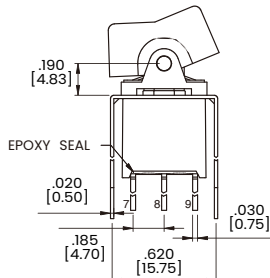
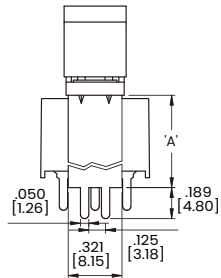

OPTION CODE	DIM.'A'
U2	.551 [14.00]
VS3	.630 [16.00]

P.C.MOUNTING

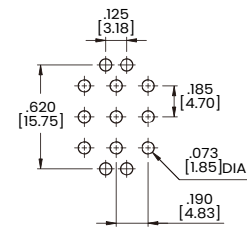

Dimensional Specs

inches [millimeters]

Termination Options

VS4-VS5 Single Pole

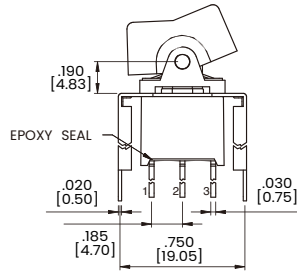
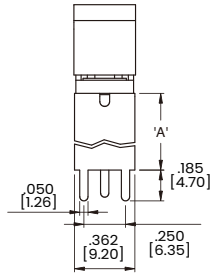

OPTION CODE	DIM.'A'
VS4	.461 [11.70]
VS5	.630 [16.00]

P.C.MOUNTING

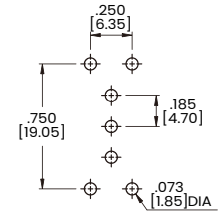

VS4-VS5 Double Pole

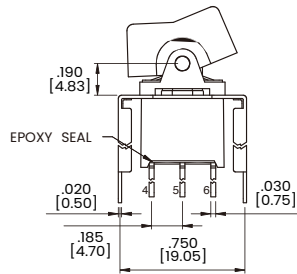
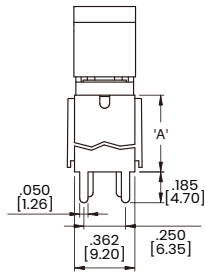

OPTION CODE	DIM.'A'
VS4	.461 [11.70]
VS5	.630 [16.00]

P.C.MOUNTING

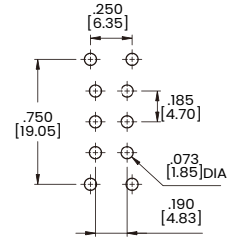

U4-VS5 Three Pole

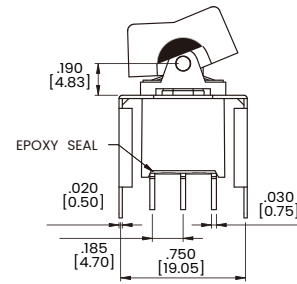
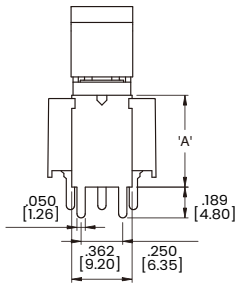

OPTION CODE	DIM.'A'
U4	.551 [14.00]
VS5	.630 [16.00]

P.C.MOUNTING

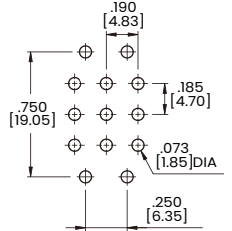

Snap-In Termination Options

M61

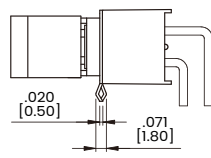
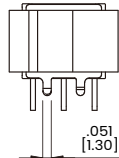
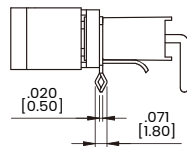
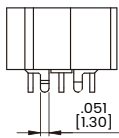

VS21, VS31

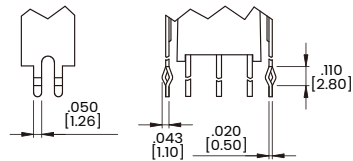

VS41, VS51

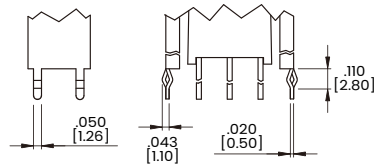

* PC Mounting for M61, M71, VS21, VS31, VS41, VS51 refer to M6, M7, VS2, VS3, VS4, VS5 respectively.

Dimensional Specs

inches [millimeters]

Single Pole

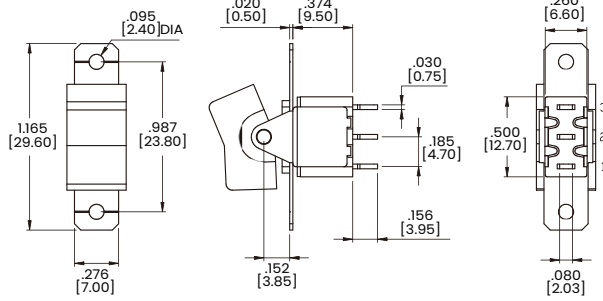

Double Pole

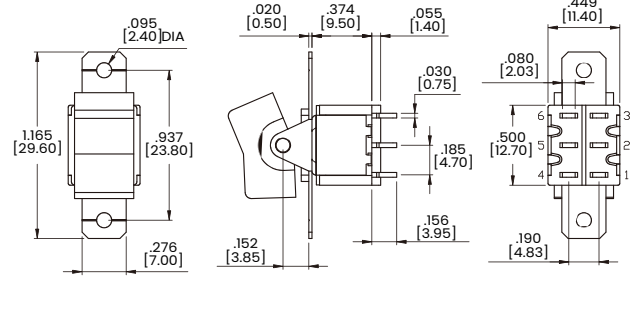

Three Pole

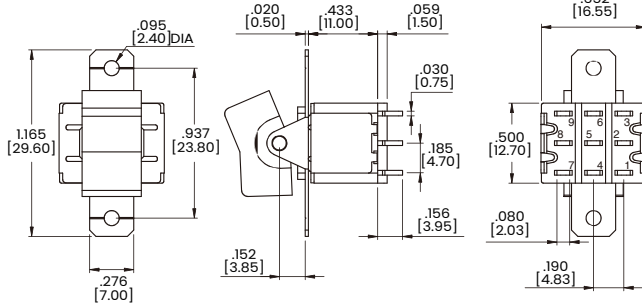

Four Pole

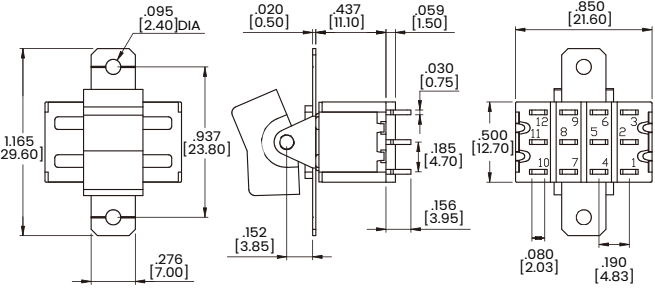

Actuator Options for Panel Rear Mount

R1

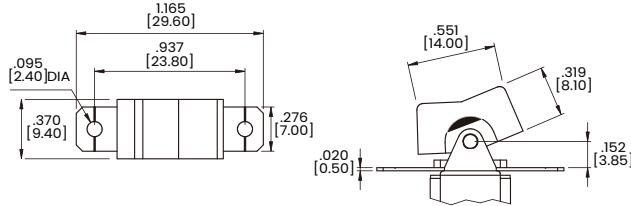

R2

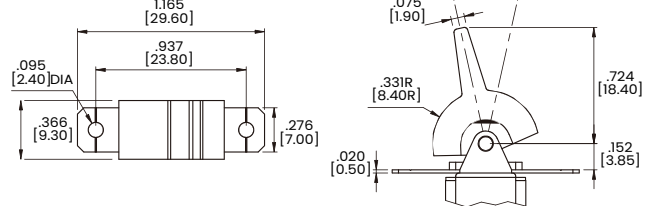

R3

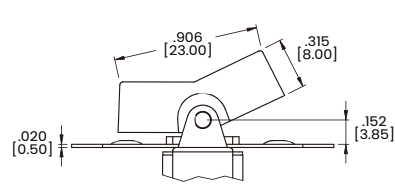
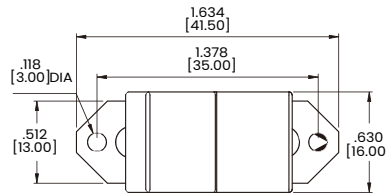

R4

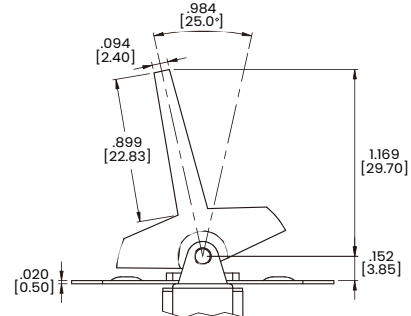
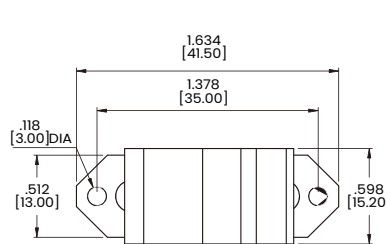

Dimensional Specs

inches [millimeters]

Actuator Options for Panel Rear Mount

R5

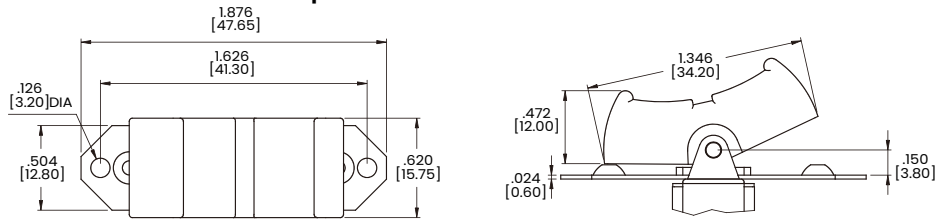

Actuator Options for Snap-In Mount

R6

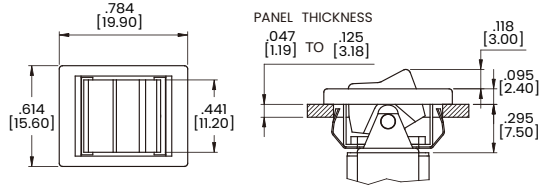

R6 WITHOUT FRAME

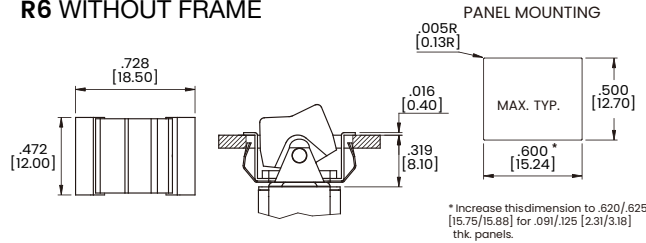

R7

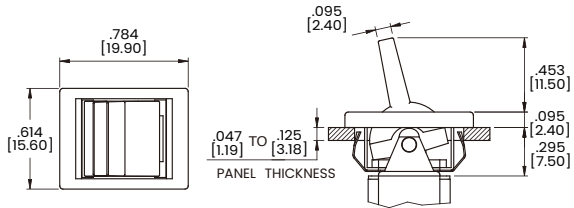

R7 WITHOUT FRAME

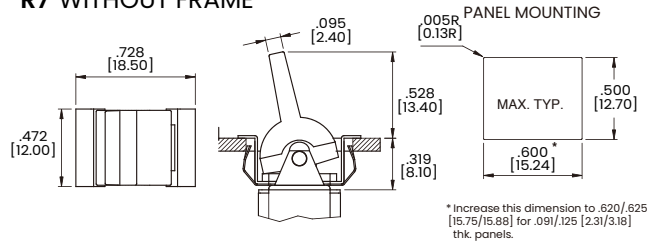

Actuator Options for PC Mount

R1

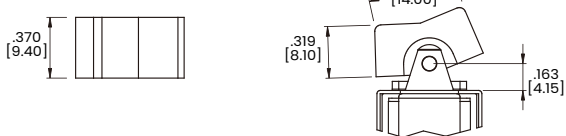

R2

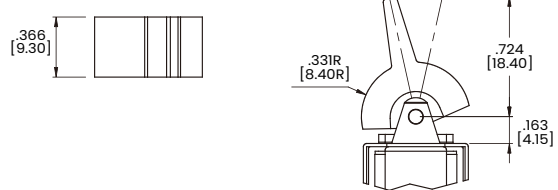

R3

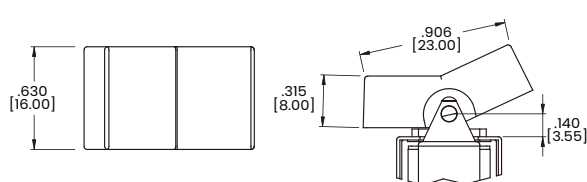

R4

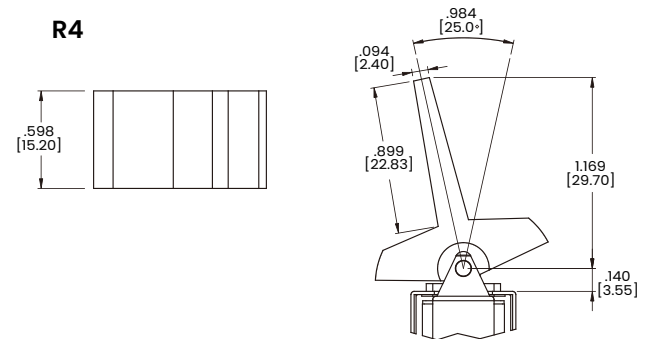

Dimensional Specs

inches [millimeters]

Actuator Options for PC Mount

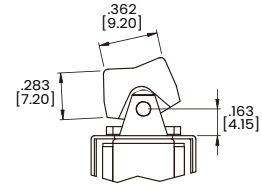
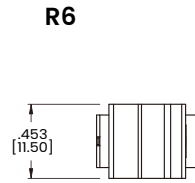
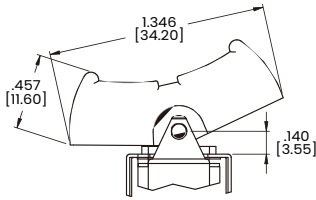
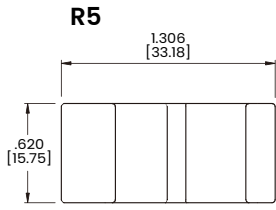

R7

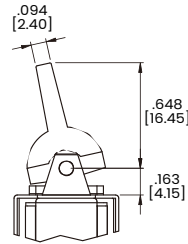
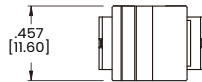

Termination Options

M1 Standard Solder Lug

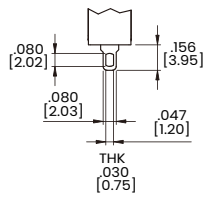

M2 PC Thru-Hole

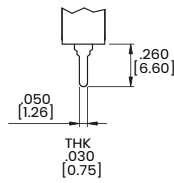

M3 Quick Connect

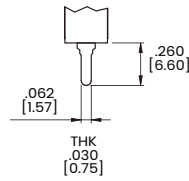

M5 Wire Wrap

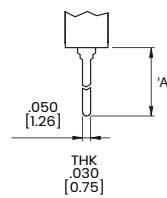

OPTION CODE	DIM. 'A'
M5-1	.750 [19.05]
M5-2	.964 [24.48]
M5-3	.425 [10.80]
M5-4	1.062 [26.97]

M6 Single Pole

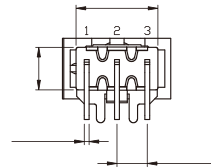
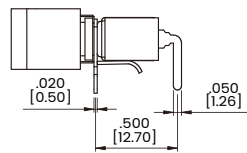
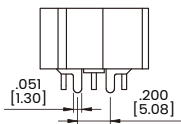

P.C.MOUNTING

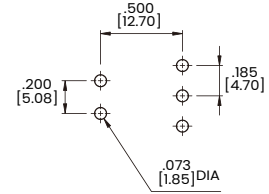

M6 Double Pole

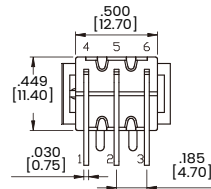
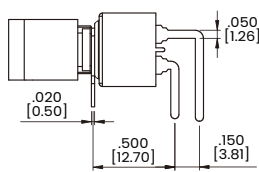
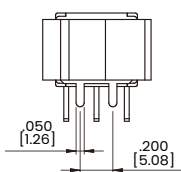

P.C.MOUNTING

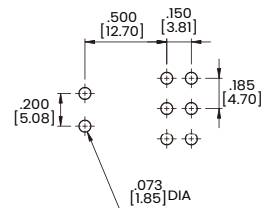

M7 Single Pole

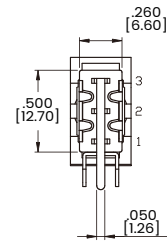
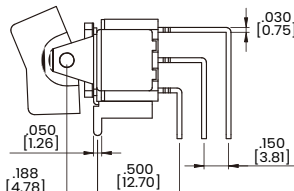
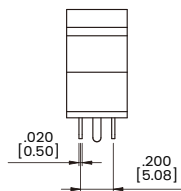

P.C.MOUNTING

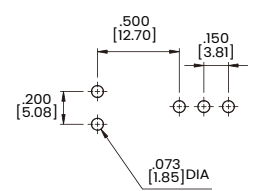

Dimensional Specs

inches [millimeters]

Termination Options

M7 Double Pole

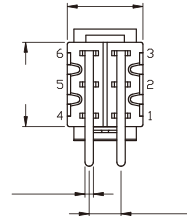
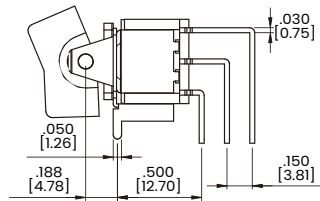
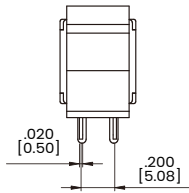

P.C.MOUNTING

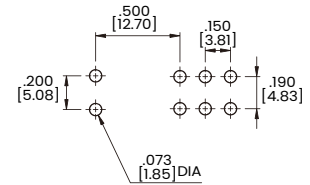

M7 Three Pole

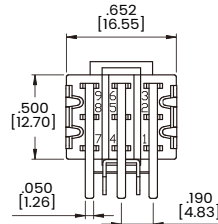
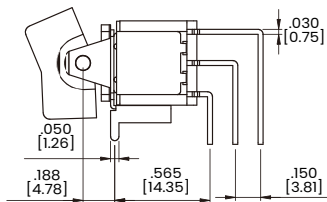
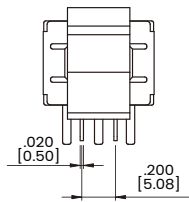

P.C.MOUNTING

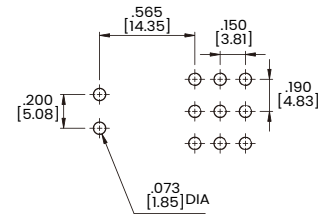

M7 Four Pole

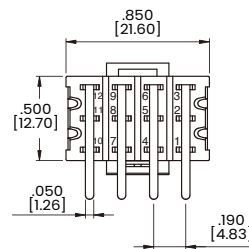
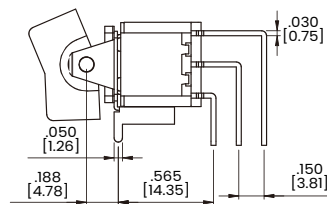
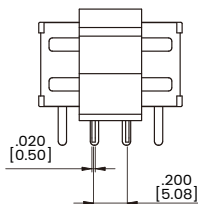

P.C.MOUNTING

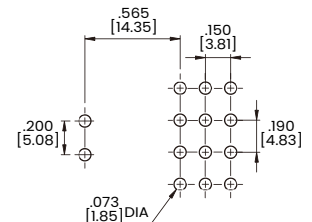

VS2-VS3 Single Pole

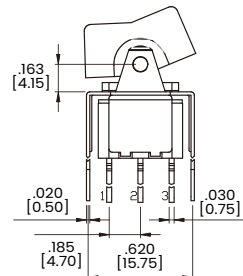
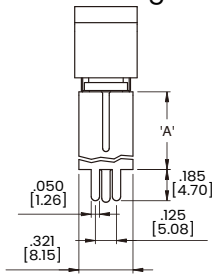

OPTION CODE	DIM. 'A'
VS2	.461 [11.70]
VS3	.630 [16.00]

P.C.MOUNTING

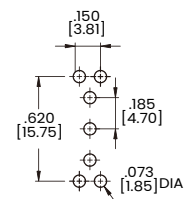

VS2-VS3 Double Pole

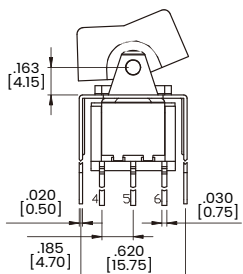
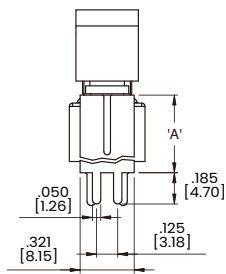

OPTION CODE	DIM. 'A'
VS2	.461 [11.70]
VS3	.630 [16.00]

P.C.MOUNTING

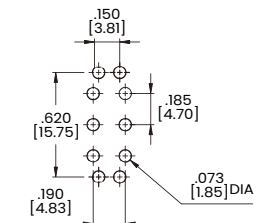

Dimensional Specs

inches [millimeters]

Termination Options

VS4-VS5 Single Pole

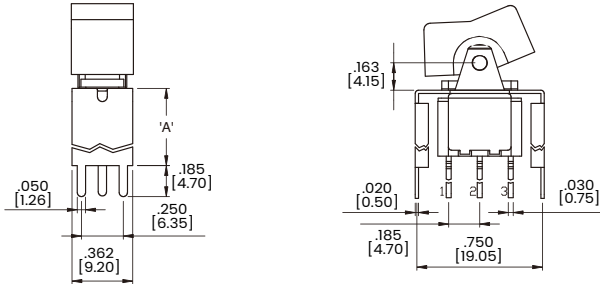

OPTION CODE	DIM.'A'
VS4	.461 [11.70]
VS5	.630 [16.00]

P.C.MOUNTING

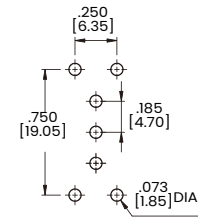

VS4-VS5 Double Pole

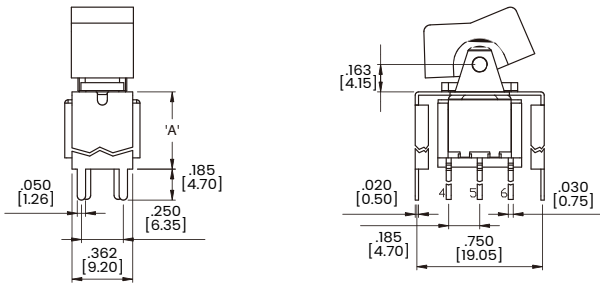

OPTION CODE	DIM.'A'
VS4	.461 [11.70]
VS5	.630 [16.00]

P.C.MOUNTING

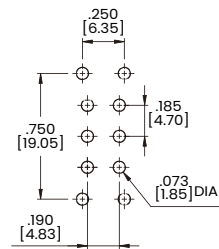

U4-VS5 Three Pole

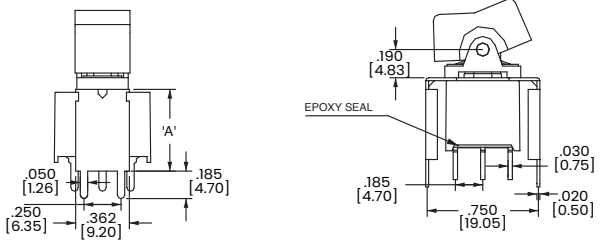

OPTION CODE	DIM.'A'
U4	.551 [14.00]
VS5	.630 [16.00]

P.C.MOUNTING

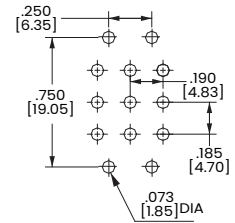

Snap-In Termination Options

M61

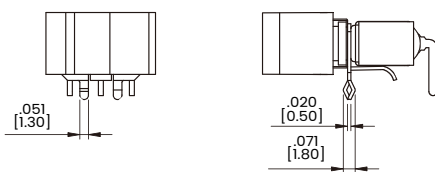

VS21, VS31

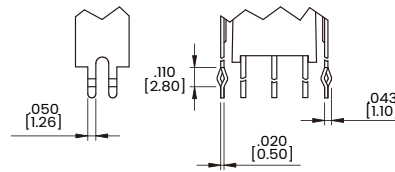

VS41, VS51

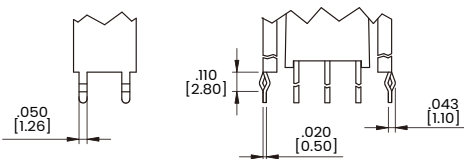

* PC Mounting for M61, VS21, VS31, VS41, VS51 refer to M6, VS2, VS3, VS4, VS5 respectively.

Authorized Sales Representatives and Distributors

Click on a region of the map below to find your local representatives and distributors or visit www.carlingtech.com/findarep.



About Carling

Founded in 1920, Carling Technologies is a leading manufacturer of electrical and electronic switches and assemblies, circuit breakers, electronic controls, power distribution units, and multiplexed power distribution systems. With six ISO9001 and IATF16949 registered manufacturing facilities and technical sales offices worldwide, Carling Technologies Sales, Service and Engineering teams do much more than manufacture electrical components, they engineer powerful solutions! To learn more about Carling please visit www.carlingtech.com/company-profile.

To view all of Carling's environmental, quality, health & safety certifications please visit www.carlingtech.com/environmental-certifications.