

THIS DRAWING IS UNPUBLISHED. RELEASED FOR PUBLICATION 2011
 © COPYRIGHT 2011 ALL RIGHTS RESERVED.

LOC		DIST		REVISIONS			
P	LTR	DESCRIPTION	DATE	DWN	APVD		
	B2	REVISED PER ECO-12-007712	24APR2012	KH	MS		

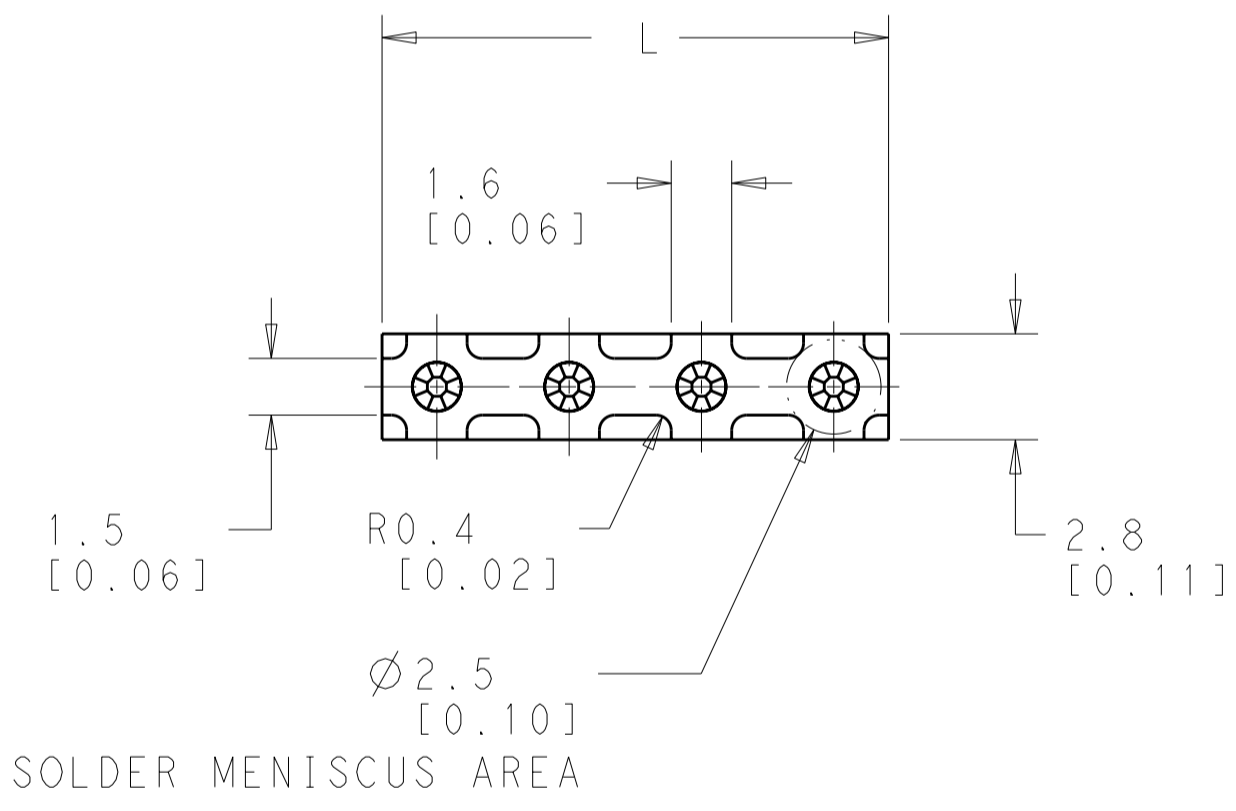
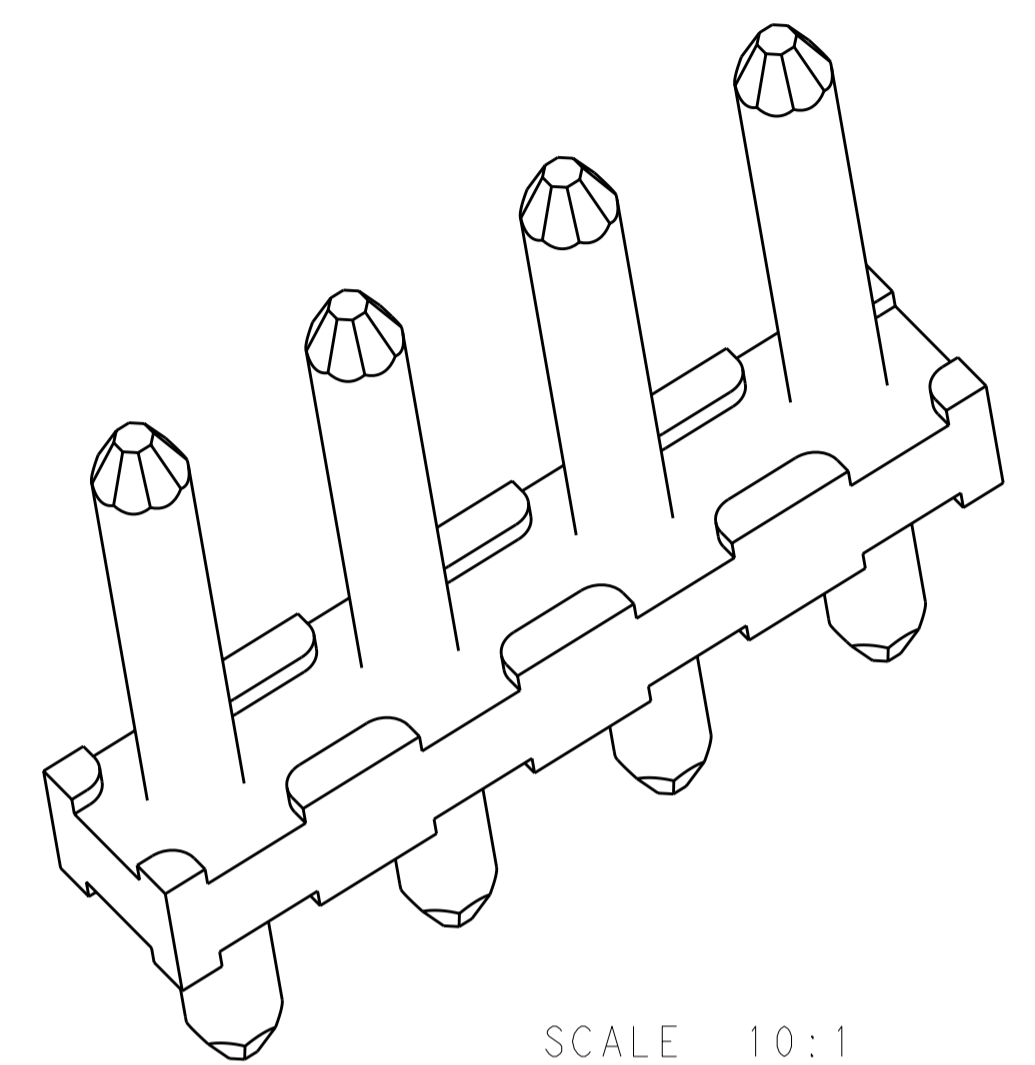
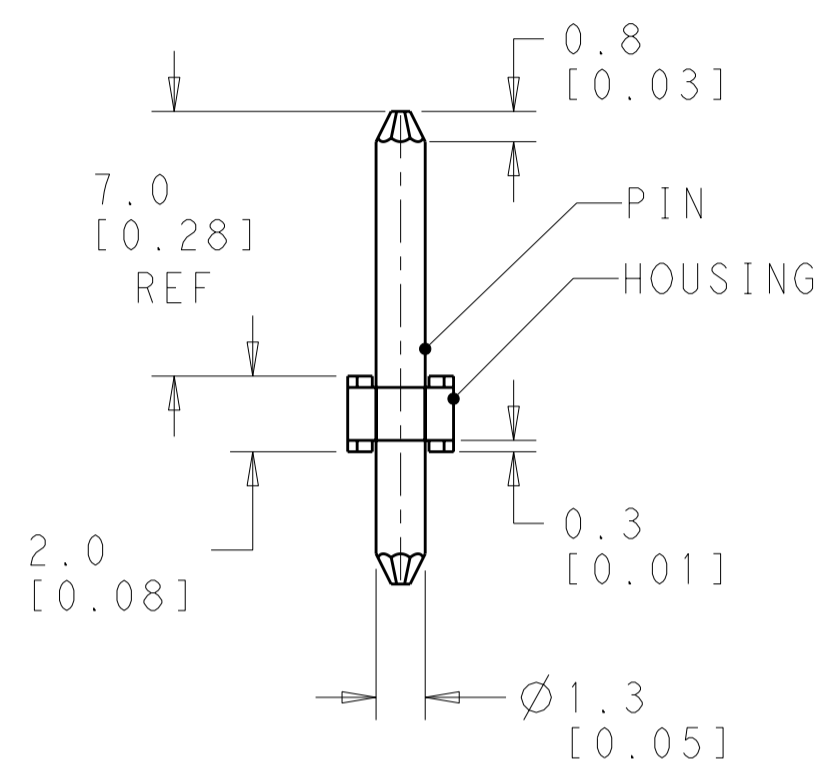
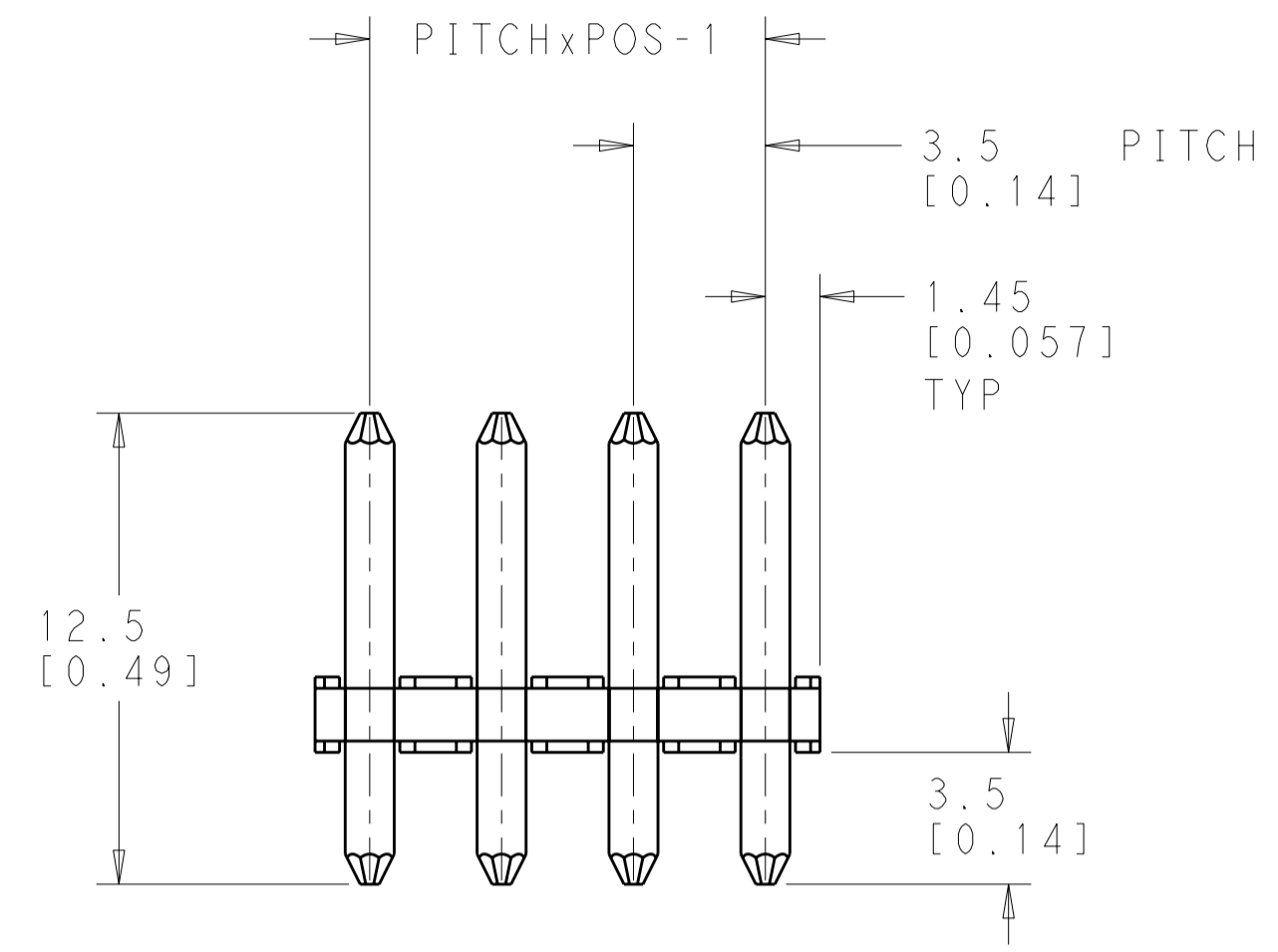

NOTE

MATERIALS:
 HOUSING-POLYAMIDE, COLOR-GREEN
 PIN- COPPER ALLOY - TIN PLATE

MECHANICAL:
 RECOMMENDED PCB HOLE-1.4 to 1.5mm
 PIN DIAMETER-1.30
 PIN LENGTH (MATING)-7.00 MM
 PIN LENGTH (PCB)-3.50 MM
 OPERATING TEMPERATURE--40°C TO +110°C

ELECTRICAL:
 VOLTAGE RATING- 150 VOLTS
 CURRENT RATING-2 AMP
 CONTACT RESISTANCE-15 MILLOHM MAX
 INSULATION RESISTANCE-10⁹ OHMS MIN (500V DC)

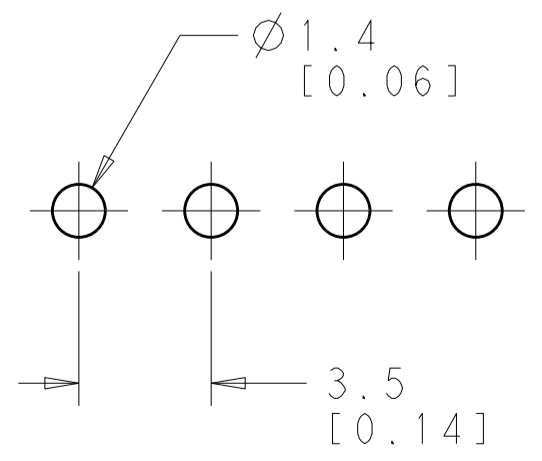

27.40 [1.079]	8	1986717-8
23.90 [0.941]	7	1986717-7
20.40 [0.803]	6	1986717-6
16.90 [0.665]	5	1986717-5
13.40 [0.528]	4	1986717-4
9.90 [0.390]	3	1986717-3
6.40 [0.252]	2	1986717-2
DIM L	POS	PART NO

- 4 AS SHOWN

THIS DRAWING IS A CONTROLLED DOCUMENT.		DWN YASHKUMAR 09NOV2011	TE Connectivity	
DIMENSIONS: MM [INCH]		CHK SARVER MICHAEL 09NOV2011		
TOLERANCES UNLESS OTHERWISE SPECIFIED:		APVD SARVER MICHAEL 09NOV2011	NAME MALE CONNECTOR, UNSHROUDED HEADER WITH STANDARD BASE-SOLDERABLE UP TO 275DEG C STRAIGHT, SIDE STACKABLE, PIN 1.3 mm 02 - 8 POLES PITCH 3.50mm	
0 PLC ±-		PRODUCT SPEC	SIZE	CAGE CODE
1 PLC ±0.20		APPLICATION SPEC	A200779	C=1986717
2 PLC ±0.20		WEIGHT	SCALE 5:1	SHEET 1 OF 1
3 PLC ±-		CUSTOMER DRAWING	REV B2	
4 PLC ±-				
ANGLES ±°				
FINISH				

Mouser Electronics

Authorized Distributor

Click to View Pricing, Inventory, Delivery & Lifecycle Information:

[TE Connectivity:](#)

[1986717-2](#)