

# PTPOWER 35-PE - Ground terminal



3212066

<https://www.phoenixcontact.com/us/products/3212066>

Please be informed that the data shown in this PDF document is generated from our online catalog. Please find the complete data in the user documentation. Our general terms of use for downloads are valid.

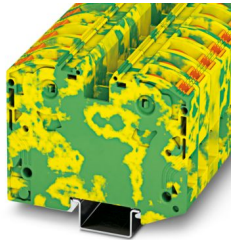

Ground terminal, number of connections: 2, connection method: PowerTurn connection, Rated cross section: 35 mm<sup>2</sup>, cross section: 2.5 mm<sup>2</sup> - 35 mm<sup>2</sup>, mounting type: NS 35/15, color: green-yellow

## Your advantages

- Quick and easy connection is now also possible for large conductors with the high-current terminal block
- The compact design and front connection enable wiring in a confined space
- The Push-in connection terminal blocks are characterized by the system features of the CLIPLINE complete system and by easy and tool-free wiring of conductors with ferrules or solid conductors
- In addition to the testing option in the double function shaft, all terminal blocks provide an additional test pick-off

## Commercial data

Item number	3212066
Packing unit	10 pc
Minimum order quantity	10 pc
Sales key	BE22
Product key	BE2221
Catalog page	Page 135 (C-1-2019)
GTIN	4046356726030
Weight per piece (including packing)	126.9 g
Weight per piece (excluding packing)	122 g
Customs tariff number	85369010
Country of origin	PL

# PTPOWER 35-PE - Ground terminal



3212066

<https://www.phoenixcontact.com/us/products/3212066>

## Technical data

### Product properties

Product type	Ground terminal block
Number of connections	2
Number of rows	1

### Insulation characteristics

Overvoltage category	III
Degree of pollution	3

### Electrical properties

Rated surge voltage	8 kV
Maximum power dissipation for nominal condition	4.06 W

### Connection data

Grounding foot	Yes
Number of connections per level	2
Nominal cross section	35 mm <sup>2</sup>
Rated cross section AWG	2
Note	Use an appropriate NS 35... copper or aluminum DIN rail for connection cross sections > 35 mm <sup>2</sup> /2 AWG.
Stripping length	25 mm
Conductor cross section rigid	2.5 mm <sup>2</sup> ... 35 mm <sup>2</sup>
Cross section AWG	12 ... 2 (converted acc. to IEC)
Conductor cross section flexible	2.5 mm <sup>2</sup> ... 35 mm <sup>2</sup>
Conductor cross section, flexible [AWG]	12 ... 2 (converted acc. to IEC)
Conductor cross-section flexible (ferrule without plastic sleeve)	2.5 mm <sup>2</sup> ... 35 mm <sup>2</sup>
Flexible conductor cross section (ferrule with plastic sleeve)	2.5 mm <sup>2</sup> ... 35 mm <sup>2</sup>
Nominal cross section	35 mm <sup>2</sup>

### Connection cross sections directly pluggable

Conductor cross section rigid	2.5 mm <sup>2</sup> ... 35 mm <sup>2</sup>
Conductor cross section, rigid [AWG]	12 ... 2 (converted acc. to IEC)
Conductor cross-section flexible (ferrule without plastic sleeve)	2.5 mm <sup>2</sup> ... 35 mm <sup>2</sup>
Flexible conductor cross section (ferrule with plastic sleeve)	2.5 mm <sup>2</sup> ... 35 mm <sup>2</sup>

### Ex data

#### Rated data (ATEX/IECEx)

Identification	Ⓔ II 2 GD Ex eb IIC Gb
Operating temperature range	-60 °C ... 110 °C
Ex-certified accessories	1206612 SZF 3-1,0X5,5 1201662 E/AL-NS 35
output	(Permanent)

# PTPOWER 35-PE - Ground terminal



3212066

<https://www.phoenixcontact.com/us/products/3212066>

## Ex connection data General

Ferrule length	25 mm
Stripping length	25 mm
Nominal cross section	35 mm <sup>2</sup>
Rated cross section AWG	2
Connection capacity rigid	2.5 mm <sup>2</sup> ... 35 mm <sup>2</sup>
Connection capacity AWG	12 ... 2
Conductor cross section flexible, with ferrule without plastic sleeve min.	6 mm <sup>2</sup>
Conductor cross section flexible, with ferrule without plastic sleeve max.	35 mm <sup>2</sup>

## Dimensions

Width	16 mm
Height	91.6 mm
Depth on NS 35/7,5	69.8 mm
Depth on NS 35/15	77.3 mm

## Material specifications

Color	green-yellow
Flammability rating according to UL 94	V0
Insulating material group	I
Insulating material	PA
Static insulating material application in cold	-60 °C
Temperature index of insulation material (DIN EN 60216-1 (VDE 0304-21))	125 °C
Relative insulation material temperature index (Elec., UL 746 B)	130 °C
Fire protection for rail vehicles (DIN EN 45545-2) R22	HL 1 - HL 3
Fire protection for rail vehicles (DIN EN 45545-2) R23	HL 1 - HL 3
Fire protection for rail vehicles (DIN EN 45545-2) R24	HL 1 - HL 3
Fire protection for rail vehicles (DIN EN 45545-2) R26	HL 1 - HL 3
Calorimetric heat release NFPA 130 (ASTM E 1354)	27,5 MJ/kg
Surface flammability NFPA 130 (ASTM E 162)	passed
Specific optical density of smoke NFPA 130 (ASTM E 662)	passed
Smoke gas toxicity NFPA 130 (SMP 800C)	passed

## Mechanical properties

### Mechanical data

Open side panel	No
-----------------	----

## Environmental and real-life conditions

### Oscillation/broadband noise

Specification	DIN EN 50155 (VDE 0115-200):2008-03
Spectrum	Service life test category 2, bogie-mounted

# PTPOWER 35-PE - Ground terminal



3212066

<https://www.phoenixcontact.com/us/products/3212066>

Frequency	$f_1 = 5 \text{ Hz}$ to $f_2 = 250 \text{ Hz}$
ASD level	6.12 (m/s <sup>2</sup> ) <sup>2</sup> /Hz
Acceleration	3.12g
Test duration per axis	5 h
Test directions	X-, Y- and Z-axis
Result	Test passed

## Shocks

Specification	DIN EN 50155 (VDE 0115-200):2008-03
Pulse shape	Half-sine
Acceleration	30g
Shock duration	18 ms
Number of shocks per direction	3
Test directions	X-, Y- and Z-axis (pos. and neg.)
Result	Test passed

## Ambient conditions

Ambient temperature (operation)	-60 °C ... 110 °C (Operating temperature range incl. self-heating; for max. short-term operating temperature, see RTI Elec.)
Ambient temperature (storage/transport)	-25 °C ... 60 °C (for a short time, not exceeding 24 h, -60 °C to +70 °C)
Ambient temperature (assembly)	-5 °C ... 70 °C
Ambient temperature (actuation)	-5 °C ... 70 °C
Permissible humidity (operation)	20 % ... 90 %
Permissible humidity (storage/transport)	30 % ... 70 %

## Mounting

Mounting type	NS 35/15
---------------	----------

# PPOWER 35-PE - Ground terminal

3212066

<https://www.phoenixcontact.com/us/products/3212066>

## Drawings

Circuit diagram

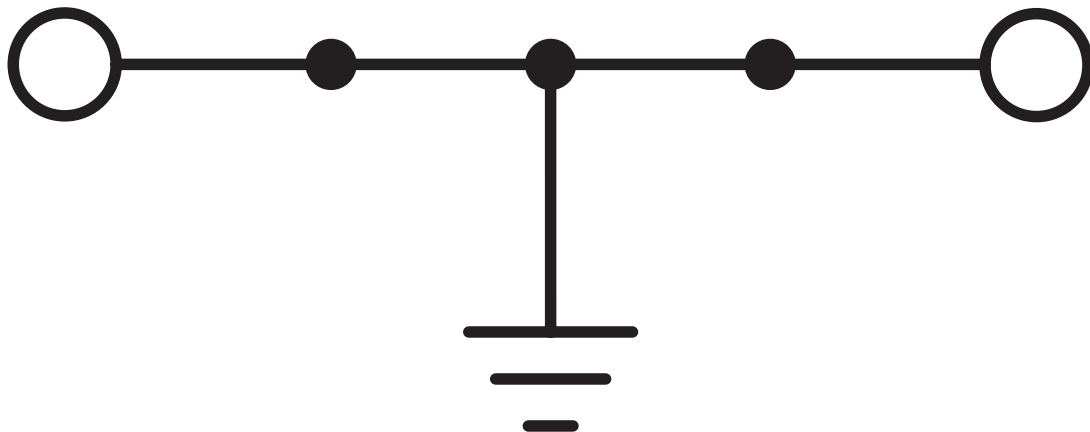

# PTPOWER 35-PE - Ground terminal

3212066

<https://www.phoenixcontact.com/us/products/3212066>



Schematic diagram

## PTPOWER



AGK 10-PTPOWER	0,5 mm <sup>2</sup> ... 16 mm <sup>2</sup>	18 mm
PTPOWER 35	2,5 mm <sup>2</sup> ... 35 mm <sup>2</sup>	25 mm
PTPOWER 50	10 mm <sup>2</sup> ... 50 mm <sup>2</sup>	32 mm
PTPOWER 95	25 mm <sup>2</sup> ... 95 mm <sup>2</sup>	40 mm
PTPOWER 185	95 mm <sup>2</sup> ... 185 mm <sup>2</sup>	40 mm

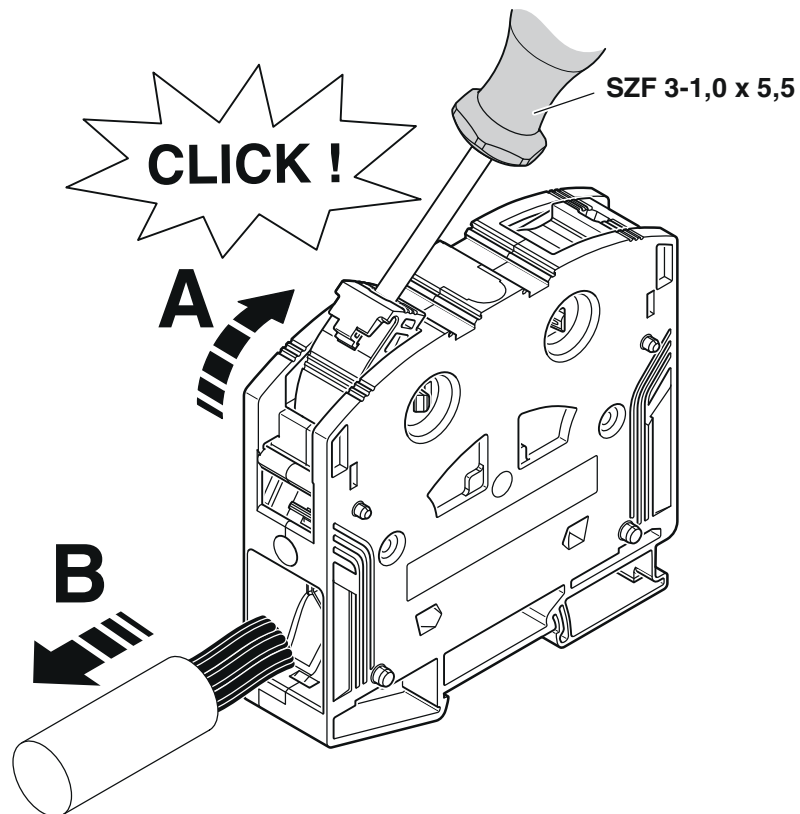

# PTPOWER 35-PE - Ground terminal



3212066

<https://www.phoenixcontact.com/us/products/3212066>

## Approvals

To download certificates, visit the product detail page: <https://www.phoenixcontact.com/us/products/3212066>

 **CSA**  
Approval ID: 13631

 **cUL Recognized**  
Approval ID: E60425

	Nominal voltage $U_N$	Nominal current $I_N$	Cross section AWG	Cross section $mm^2$
Use group C	-	-	14 - 2	-

 **UL Recognized**  
Approval ID: E60425

	Nominal voltage $U_N$	Nominal current $I_N$	Cross section AWG	Cross section $mm^2$
Use group E	-	-	14 - 2	-

 **EAC**  
Approval ID: RU C-DE.BL08.B.00644

**DNV**  
Approval ID: TAE0000029

 **CSA**  
Approval ID: 13631

 **CCC**  
Approval ID: 2020322313000630

 **UKCA-EX**  
Approval ID: CML 22UKEX1227U

 **IECEX**  
Approval ID: IECExSEV14.0013U

 **ATEX**

# PTPOWER 35-PE - Ground terminal



3212066

<https://www.phoenixcontact.com/us/products/3212066>

Approval ID: SEV14ATEX0156U

	Nominal voltage $U_N$	Nominal current $I_N$	Cross section AWG	Cross section $mm^2$
Only rigid conductors	-	-	-	2.5 - 35
multi-stranded with ferrule	-	-	-	6 - 35



**IECEx**

Approval ID: IECExSEV14.0013U

**cULus Recognized**



# PTPOWER 35-PE - Ground terminal



3212066

<https://www.phoenixcontact.com/us/products/3212066>

## Classifications

### ECLASS

ECLASS-11.0	27141141
ECLASS-13.0	27250103

### ETIM

ETIM 9.0	EC000901
----------	----------

### UNSPSC

UNSPSC 21.0	39121400
-------------	----------

# PTPOWER 35-PE - Ground terminal



3212066

<https://www.phoenixcontact.com/us/products/3212066>

## Environmental product compliance

### EU RoHS

Fulfills EU RoHS substance requirements	Yes, No exemptions
---	--------------------

### China RoHS

Environment friendly use period (EFUP)	EFUP-E
	No hazardous substances above the limits

### EU REACH SVHC

REACH candidate substance (CAS No.)	No substance above 0.1 wt%
-------------------------------------	----------------------------

# PTPOWER 35-PE - Ground terminal

3212066

<https://www.phoenixcontact.com/us/products/3212066>



## Accessories

### FBS 2-16 - Plug-in bridge

3005963

<https://www.phoenixcontact.com/us/products/3005963>



Plug-in bridge, pitch: 16 mm, number of positions: 2, length: 44 mm, color: red

---

### PAI-ST 35/1000MM - Test adapter

3029994

<https://www.phoenixcontact.com/us/products/3029994>



Test adapter, number of positions: 1, color: red

# PTPOWER 35-PE - Ground terminal

3212066

<https://www.phoenixcontact.com/us/products/3212066>

## NS 35/15 PERF 2000MM - DIN rail perforated

1201730

<https://www.phoenixcontact.com/us/products/1201730>



DIN rail perforated, Pack of 25 (50 m), similar to EN 60715, material: Steel, galvanized, passivated with a thick layer, Standard profile, color: silver

---

## NS 35/15 UNPERF 2000MM - DIN rail, unperforated

1201714

<https://www.phoenixcontact.com/us/products/1201714>



DIN rail, unperforated, Pack of 25 (50 m), similar to EN 60715, material: Steel, galvanized, passivated with a thick layer, Standard profile, color: silver

# PTPOWER 35-PE - Ground terminal

3212066

<https://www.phoenixcontact.com/us/products/3212066>



## NS 35/15 WH PERF 2000MM - DIN rail perforated

0806602

<https://www.phoenixcontact.com/us/products/0806602>



DIN rail perforated, Pack of 25 (50 m), similar to EN 60715, material: Steel, Galvanized, white passivated, Standard profile, color: white

---

## NS 35/15 WH UNPERF 2000MM-VPE 10 - DIN rail, unperforated

1204135

<https://www.phoenixcontact.com/us/products/1204135>



DIN rail, unperforated, Pack of 10 (20 m), similar to EN 60715, material: Steel, Galvanized, white passivated, Standard profile, color: silver

# PTPOWER 35-PE - Ground terminal



3212066

<https://www.phoenixcontact.com/us/products/3212066>

## NS 35/15 AL UNPERF 2000MM - DIN rail, unperforated

1201756

<https://www.phoenixcontact.com/us/products/1201756>



DIN rail, unperforated, similar to EN 60715, material: Aluminum, uncoated, Standard profile, color: silver

---

## NS 35/15 ZN PERF 2000MM - DIN rail perforated

1206599

<https://www.phoenixcontact.com/us/products/1206599>



DIN rail perforated, Pack of 25 (50 m), similar to EN 60715, material: Steel, galvanized, Standard profile, color: silver

# PTPOWER 35-PE - Ground terminal

3212066

<https://www.phoenixcontact.com/us/products/3212066>



## NS 35/15 ZN UNPERF 2000MM - DIN rail, unperforated

1206586

<https://www.phoenixcontact.com/us/products/1206586>



DIN rail, unperforated, Pack of 25 (50 m), similar to EN 60715, material: Steel, galvanized, Standard profile, color: silver

---

## NS 35/15 CU UNPERF 2000MM-VPE 10 - DIN rail, unperforated

1201895

<https://www.phoenixcontact.com/us/products/1201895>



DIN rail, unperforated, Pack of 10 (20 m), similar to EN 60715, material: Copper, uncoated, Standard profile, color: copper-colored

# PTPOWER 35-PE - Ground terminal



3212066

<https://www.phoenixcontact.com/us/products/3212066>

## NS 35/15 CAP - End cap

1206573

<https://www.phoenixcontact.com/us/products/1206573>

DIN rail end piece, for DIN rail NS 35/15



---

## TMT (EX9,5)R - Marker for terminal blocks

0828295

<https://www.phoenixcontact.com/us/products/0828295>



Marker for terminal blocks, Roll, white, unlabeled, can be labeled with: THERMOMARK E.300 (D)/600 (D), THERMOMARK ROLL 2.0, THERMOMARK ROLL, THERMOMARK ROLL X1, THERMOMARK ROLLMASTER 300/600, THERMOMARK X1.2, mounting type: snapped, snap into tall marker groove, for terminal block width: 30000 mm, lettering field size: 9.5 x 50000 mm, Number of individual labels: 1



# PTPOWER 35-PE - Ground terminal



3212066

<https://www.phoenixcontact.com/us/products/3212066>

## US-TM 100 - Marker for terminal blocks

0829255

<https://www.phoenixcontact.com/us/products/0829255>



Marker for terminal blocks, Card, white, unlabeled, can be labeled with: BLUEMARK ID COLOR, BLUEMARK ID, THERMOMARK PRIME, THERMOMARK CARD 2.0, THERMOMARK CARD, mounting type: snapped, lettering field size: 104 x 9.8 mm, Number of individual labels: 13

---

## ZBF10:UNBEDRUCKT - Zack Marker strip, flat

0809997

<https://www.phoenixcontact.com/us/products/0809997>



Zack Marker strip, flat, Strip, white, unlabeled, can be labeled with: CMS-P1-PLOTTER, PLOTMARK, mounting type: snapped, for terminal block width: 10 mm, lettering field size: 5.15 x 10 mm, Number of individual labels: 10

# PTPOWER 35-PE - Ground terminal

3212066

<https://www.phoenixcontact.com/us/products/3212066>



## ZBF10 CUS - Zack Marker strip, flat

0825031

<https://www.phoenixcontact.com/us/products/0825031>



Zack Marker strip, flat, can be ordered: Strip, white, labeled according to customer specifications, mounting type: snap into flat marker groove, for terminal block width: 10 mm, lettering field size: 5.15 x 10 mm, Number of individual labels: 10

---

## ZBF10,LGS:FORTL.ZAHLEN - Zack Marker strip, flat

0810009

<https://www.phoenixcontact.com/us/products/0810009>



Zack Marker strip, flat, Strip, white, labeled, printed horizontally: consecutive numbers 1 ... 10, 11 ... 20, etc. up to 91 ... 100, mounting type: snapped, for terminal block width: 10 mm, lettering field size: 5.15 x 10 mm, Number of individual labels: 10

# PTPOWER 35-PE - Ground terminal

3212066

<https://www.phoenixcontact.com/us/products/3212066>



## ZBF10,QR:FORTL.ZAHLEN - Zack Marker strip, flat

0810025

<https://www.phoenixcontact.com/us/products/0810025>



Zack Marker strip, flat, Strip, white, labeled, Printed vertically: consecutive numbers 1 ... 10, 11 ... 20, etc. up to 91 ... 100, mounting type: snapped, for terminal block width: 10 mm, lettering field size: 5.15 x 10 mm, Number of individual labels: 10

---

## UC-TMF 10 - Marker for terminal blocks

0818124

<https://www.phoenixcontact.com/us/products/0818124>



Marker for terminal blocks, Sheet, white, unlabeled, can be labeled with: BLUEMARK ID COLOR, BLUEMARK ID, BLUEMARK CLED, PLOTMARK, CMS-P1-PLOTTER, mounting type: snapped, for terminal block width: 10.2 mm, lettering field size: 9.6 x 5.1 mm, Number of individual labels: 48

# PTPOWER 35-PE - Ground terminal



3212066

<https://www.phoenixcontact.com/us/products/3212066>

## UC-TMF 10 CUS - Marker for terminal blocks

0824662

<https://www.phoenixcontact.com/us/products/0824662>



Marker for terminal blocks, can be ordered: by sheet, white, labeled according to customer specifications, mounting type: snap into flat marker groove, for terminal block width: 10.2 mm, lettering field size: 9.6 x 5.1 mm, Number of individual labels: 48

---

## UCT-TMF 10 - Marker for terminal blocks

0829204

<https://www.phoenixcontact.com/us/products/0829204>



Marker for terminal blocks, Sheet, white, unlabeled, can be labeled with: TOPMARK NEO, TOPMARK LASER, BLUEMARK ID COLOR, BLUEMARK ID, BLUEMARK CLED, THERMOMARK PRIME, THERMOMARK CARD 2.0, THERMOMARK CARD, mounting type: snapped, for terminal block width: 10.2 mm, lettering field size: 9.4 x 4.7 mm, Number of individual labels: 36

# PTPOWER 35-PE - Ground terminal

3212066

<https://www.phoenixcontact.com/us/products/3212066>



## UCT-TMF 10 CUS - Marker for terminal blocks

0829679

<https://www.phoenixcontact.com/us/products/0829679>



Marker for terminal blocks, can be ordered: by sheet, white, labeled according to customer specifications, mounting type: snap into flat marker groove, for terminal block width: 10.2 mm, lettering field size: 9.4 x 4.7 mm, Number of individual labels: 36

---

## ZB 10:UNBEDRUCKT - Zack marker strip

1053001

<https://www.phoenixcontact.com/us/products/1053001>



Zack marker strip, Strip, white, unlabeled, can be labeled with: PLOTMARK, CMS-P1-PLOTTER, mounting type: snapped, for terminal block width: 10.2 mm, lettering field size: 10.5 x 10.15 mm, Number of individual labels: 10

# PTPOWER 35-PE - Ground terminal

3212066

<https://www.phoenixcontact.com/us/products/3212066>



## ZB 10 CUS - Zack marker strip

0824941

<https://www.phoenixcontact.com/us/products/0824941>



Zack marker strip, can be ordered: Strip, white, labeled according to customer specifications, mounting type: snap into tall marker groove, for terminal block width: 10.2 mm, lettering field size: 10,15 x 10,5 mm, Number of individual labels: 10

---

## ZB10,LGS:FORTL.ZAHLEN - Zack marker strip

1053014

<https://www.phoenixcontact.com/us/products/1053014>



Zack marker strip, Strip, white, labeled, can be labeled with: CMS-P1-PLOTTER, printed horizontally: consecutive numbers 1 ... 10, 11 ... 20, etc. up to 91 ... 100, mounting type: snapped, for terminal block width: 10.2 mm, lettering field size: 10,15 x 10,5 mm, Number of individual labels: 10

# PTPOWER 35-PE - Ground terminal

3212066

<https://www.phoenixcontact.com/us/products/3212066>

## ZB10,QR:FORTL.ZAHLEN - Zack marker strip

1053027

<https://www.phoenixcontact.com/us/products/1053027>



Zack marker strip, Strip, white, labeled, can be labeled with: CMS-P1-PLOTTER, Printed vertically: consecutive numbers 1 ... 10, 11 ... 20, etc. up to 91 ... 100, mounting type: snapped, for terminal block width: 10.2 mm, lettering field size: 10,15 x 10,5 mm, Number of individual labels: 10

---

## ZB10,LGS:L1-N,PE - Marker for terminal blocks

1053412

<https://www.phoenixcontact.com/us/products/1053412>



Marker for terminal blocks, Strip, white, labeled, can be labeled with: CMS-P1-PLOTTER, horizontal: L1, L2, L3, N, PE, L1, L2, L3, N, PE, mounting type: snapped, for terminal block width: 10.2 mm, lettering field size: 10,15 x 10,5 mm, Number of individual labels: 10

# PTPOWER 35-PE - Ground terminal

3212066

<https://www.phoenixcontact.com/us/products/3212066>



## ZB10,LGS:U-N - Marker for terminal blocks

1053438

<https://www.phoenixcontact.com/us/products/1053438>



Marker for terminal blocks, Strip, white, labeled, can be labeled with: CMS-P1-PLOTTER, horizontal: U, V, W, N, GND, U, V, W, N, GND, mounting type: snapped, for terminal block width: 10.2 mm, lettering field size: 10,15 x 10,5 mm, Number of individual labels: 10

---

## UC-TM 10 - Marker for terminal blocks

0818069

<https://www.phoenixcontact.com/us/products/0818069>



Marker for terminal blocks, Sheet, white, unlabeled, can be labeled with: BLUEMARK ID COLOR, BLUEMARK ID, BLUEMARK CLED, PLOTMARK, CMS-P1-PLOTTER, mounting type: snapped, for terminal block width: 10.2 mm, lettering field size: 9.6 x 10.5 mm, Number of individual labels: 48



# PTPOWER 35-PE - Ground terminal



3212066

<https://www.phoenixcontact.com/us/products/3212066>

## UC-TM 10 CUS - Marker for terminal blocks

0824605

<https://www.phoenixcontact.com/us/products/0824605>



Marker for terminal blocks, can be ordered: by sheet, white, labeled according to customer specifications, mounting type: snap into tall marker groove, for terminal block width: 10.2 mm, lettering field size: 9.6 x 10.5 mm, Number of individual labels: 48

---

## UCT-TM 10 - Marker for terminal blocks

0829142

<https://www.phoenixcontact.com/us/products/0829142>



Marker for terminal blocks, Sheet, white, unlabeled, can be labeled with: TOPMARK NEO, TOPMARK LASER, BLUEMARK ID COLOR, BLUEMARK ID, BLUEMARK CLED, THERMOMARK PRIME, THERMOMARK CARD 2.0, THERMOMARK CARD, mounting type: snapped, for terminal block width: 10.2 mm, lettering field size: 8.9 x 9.6 mm, Number of individual labels: 36

# PTPOWER 35-PE - Ground terminal

3212066

<https://www.phoenixcontact.com/us/products/3212066>



## UCT-TM 10 CUS - Marker for terminal blocks

0829623

<https://www.phoenixcontact.com/us/products/0829623>



Marker for terminal blocks, can be ordered: by sheet, white, labeled according to customer specifications, mounting type: snap into tall marker groove, for terminal block width: 10.2 mm, lettering field size: 8.9 x 9.6 mm, Number of individual labels: 36

---

## SZF 3-1,0X5,5 - Screwdriver

1206612

<https://www.phoenixcontact.com/us/products/1206612>



Actuation tool, for ST terminal blocks, also suitable for use as a bladed screwdriver, size: 1.0 x 5.5 x 150 mm, 2-component grip, with non-slip grip

# PTPOWER 35-PE - Ground terminal

3212066

<https://www.phoenixcontact.com/us/products/3212066>



## SZS 0,8X4,0 VDE - Screwdriver

1212508

<https://www.phoenixcontact.com/us/products/1212508>



Screwdriver, slot-headed, VDE insulated, size: 0.8 x 4.0 x 100 mm, 2-component grip, with non-slip grip

---

## CRIMPFOX CENTRUS 6S - Crimping pliers

1213144

<https://www.phoenixcontact.com/us/products/1213144>



Crimping pliers, for uninsulated and insulated ferrules, DIN 46228 Part 1 and 4, from 0.14 mm<sup>2</sup> ... 6 mm<sup>2</sup>, also for TWIN ferrules up to 2 x 4 mm<sup>2</sup>, automatic cross section adjustment, lateral insertion, equipped with fall protection

# PTPOWER 35-PE - Ground terminal

3212066

<https://www.phoenixcontact.com/us/products/3212066>

## CRIMPFOX CENTRUS 10S - Crimping pliers

1213154

<https://www.phoenixcontact.com/us/products/1213154>



Crimping pliers, for uninsulated and insulated ferrules, DIN 46228 Part 1 and 4, from 0.14 mm<sup>2</sup> ... 10 mm<sup>2</sup>, also for TWIN ferrules up to 2 x 4 mm<sup>2</sup>, automatic cross section adjustment, lateral insertion, equipped with fall protection

---

## CRIMPFOX CENTRUS 6H - Crimping pliers

1213146

<https://www.phoenixcontact.com/us/products/1213146>



Crimping pliers, for uninsulated and insulated ferrules, DIN 46228 Part 1 and 4, from 0.14 mm<sup>2</sup> ... 6 mm<sup>2</sup>, also for TWIN ferrules up to 2 x 4 mm<sup>2</sup>, automatic cross section adjustment, lateral insertion, equipped with fall protection

# PTPOWER 35-PE - Ground terminal

3212066

<https://www.phoenixcontact.com/us/products/3212066>

## CRIMPFOX CENTRUS 10H - Crimping pliers

1213156

<https://www.phoenixcontact.com/us/products/1213156>



Crimping pliers, for uninsulated and insulated ferrules, DIN 46228 Part 1 and 4, from 0.14 mm<sup>2</sup> ... 10 mm<sup>2</sup>, also for TWIN ferrules up to 2 x 4 mm<sup>2</sup>, automatic cross section adjustment, lateral insertion, equipped with fall protection

---

## CRIMPFOX 10S - Crimping pliers

1212045

<https://www.phoenixcontact.com/us/products/1212045>



Crimping pliers, for ferrules without insulating collar according to DIN 46228 Part 1 and ferrules with insulating collar according to DIN 46228 Part 4, 0.14 mm<sup>2</sup> ... 10 mm<sup>2</sup>, unlockable pressure lock, lateral entry

# PTPOWER 35-PE - Ground terminal

3212066

<https://www.phoenixcontact.com/us/products/3212066>

## CRIMPFOX 6H - Crimping pliers

1212046

<https://www.phoenixcontact.com/us/products/1212046>



Crimping pliers, for ferrules without insulating collar according to DIN 46228 Part 1 and ferrules with insulating collar according to DIN 46228 Part 4, 0.14 mm<sup>2</sup> ... 6 mm<sup>2</sup>, unlockable pressure lock, lateral entry

---

## CRIMPFOX 2,5-M - Crimping pliers

1212719

<https://www.phoenixcontact.com/us/products/1212719>



Crimping pliers, for ferrules without insulating collar according to DIN 46228 Part 1 and ferrules with insulating collar according to DIN 46228 Part 4, 0.25 mm<sup>2</sup> ... 2.5 mm<sup>2</sup>, lateral entry, trapezoidal crimp

# PTPOWER 35-PE - Ground terminal

3212066

<https://www.phoenixcontact.com/us/products/3212066>

## CRIMPFOX 6-M - Crimping pliers

1212720

<https://www.phoenixcontact.com/us/products/1212720>



Crimping pliers, for ferrules without insulating collar according to DIN 46228 Part 1 and ferrules with insulating collar according to DIN 46228 Part 4, 0.25 mm<sup>2</sup> ... 6.0 mm<sup>2</sup>, lateral entry, trapezoidal crimp

---

## CRIMPFOX 6 - Crimping pliers

1212034

<https://www.phoenixcontact.com/us/products/1212034>



Crimping pliers, for ferrules without insulating collar according to DIN 46228 Part 1 and ferrules with insulating collar according to DIN 46228 Part 4, 0.25 mm<sup>2</sup> ... 6.0 mm<sup>2</sup>, lateral entry, trapezoidal crimp

# PTPOWER 35-PE - Ground terminal

3212066

<https://www.phoenixcontact.com/us/products/3212066>

## CRIMPFOX 6T - Crimping pliers

1212037

<https://www.phoenixcontact.com/us/products/1212037>



Crimping pliers, for ferrules without insulating collar according to DIN 46228 Part 1 and ferrules with insulating collar according to DIN 46228 Part 4, 0.25 mm<sup>2</sup> ... 6 mm<sup>2</sup>, lateral entry, trapezoidal crimp

---

## CRIMPFOX 6T-F - Crimping pliers

1212038

<https://www.phoenixcontact.com/us/products/1212038>



Crimping pliers, for ferrules without insulating collar according to DIN 46228 Part 1 and ferrules with insulating collar according to DIN 46228 Part 4, 0.25 mm<sup>2</sup> ... 6 mm<sup>2</sup>, front entry, trapezoidal crimp



# PTPOWER 35-PE - Ground terminal

3212066

<https://www.phoenixcontact.com/us/products/3212066>



## CRIMPFOX 6S-F - Crimping pliers

1212043

<https://www.phoenixcontact.com/us/products/1212043>



Crimping pliers, for ferrules without insulating collar according to DIN 46228 Part 1 and ferrules with insulating collar according to DIN 46228 Part 4, 0.5 mm<sup>2</sup> ... 6 mm<sup>2</sup>, front entry, square crimp

---

## CRIMPFOX 10 - Crimping pliers

1212721

<https://www.phoenixcontact.com/us/products/1212721>



Crimping pliers, for ferrules without insulating collar according to DIN 46228 Part 1 and ferrules with insulating collar according to DIN 46228 Part 4, 4 mm<sup>2</sup> ... 10 mm<sup>2</sup>, lateral entry, trapezoidal crimp

# PTPOWER 35-PE - Ground terminal

3212066

<https://www.phoenixcontact.com/us/products/3212066>

## CRIMPFOX 25R - Crimping pliers

1212039

<https://www.phoenixcontact.com/us/products/1212039>



Crimping pliers, for ferrules without insulating collar according to DIN 46228 Part 1 and ferrules with insulating collar according to DIN 46228 Part 4, 10 mm<sup>2</sup> ... 25 mm<sup>2</sup>, lateral entry, WM crimp

---

## CRIMPFOX 50R - Crimping pliers

1212041

<https://www.phoenixcontact.com/us/products/1212041>



Crimping pliers, for ferrules without insulating collar according to DIN 46228 Part 1 and ferrules with insulating collar according to DIN 46228 Part 4, 35 mm<sup>2</sup> ... 50 mm<sup>2</sup>, lateral entry, WM crimp

# PTPOWER 35-PE - Ground terminal

3212066

<https://www.phoenixcontact.com/us/products/3212066>



## CRIMPFOX-M - Crimping pliers

1212072

<https://www.phoenixcontact.com/us/products/1212072>



Basic pliers, for accommodating dies for a wide range of type of contacts

---

## CEC PTPOWER 35/50 - Cover

1056086

<https://www.phoenixcontact.com/us/products/1056086>



Cover, yellow, labeled: Lightning flash, mounting type: plug in

# PTPOWER 35-PE - Ground terminal



3212066

<https://www.phoenixcontact.com/us/products/3212066>

## PROJECT COMPLETE - Software

1050453

<https://www.phoenixcontact.com/us/products/1050453>



Intuitive planning and marking software for configuring terminal strips and for professional marking of marking materials for terminal blocks, conductors, cables, devices, and systems. The software is available for download

---

## A 10 -25 - Ferrule

1090628

<https://www.phoenixcontact.com/us/products/1090628>



Ferrule, color: silver

# PTPOWER 35-PE - Ground terminal

3212066

<https://www.phoenixcontact.com/us/products/3212066>

## A 16 -25 - Ferrule

1090632

<https://www.phoenixcontact.com/us/products/1090632>



Ferrule, color: silver

---

## A 25 -25 - Ferrule

1090634

<https://www.phoenixcontact.com/us/products/1090634>



Ferrule, color: silver

---

# PTPOWER 35-PE - Ground terminal



3212066

<https://www.phoenixcontact.com/us/products/3212066>

AI 35 -25 RD - Ferrule

3200713

<https://www.phoenixcontact.com/us/products/3200713>

Ferrule, sleeve length: 25 mm, color: red



---

Phoenix Contact 2024 © - all rights reserved

<https://www.phoenixcontact.com>

Phoenix Contact USA  
586 Fulling Mill Road  
Middletown, PA 17057, United States  
(+717) 944-1300  
[info@phoenixcon.com](mailto:info@phoenixcon.com)