

DATASHEET

# UF3SC120016K3S

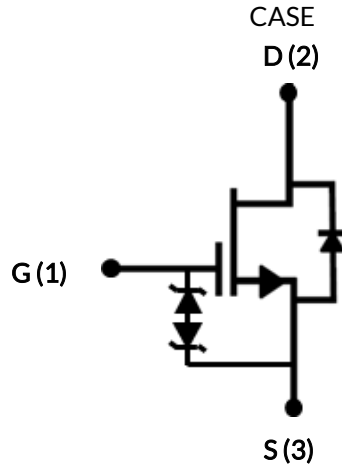
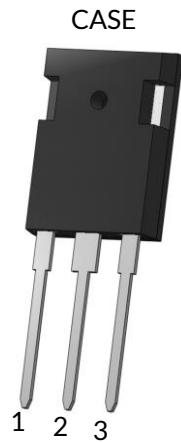

## 1200V-16mΩ SiC FET

Rev. B, December 2019

### Description

This SiC FET device is based on a unique ‘cascode’ circuit configuration, in which a normally-on SiC JFET is co-packaged with a Si MOSFET to produce a normally-off SiC FET device. The device’s standard gate-drive characteristics allows for a true “drop-in replacement” to Si IGBTs, Si FETs, SiC MOSFETs or Si superjunction devices. Available in the TO-247-3L package, this device exhibits ultra-low gate charge and exceptional reverse recovery characteristics, making it ideal for switching inductive loads when used with recommended RC-snubbers, and any application requiring standard gate drive.

### Features

- ◆ Typical on-resistance  $R_{DS(on),typ}$  of 16mΩ
- ◆ Maximum operating temperature of 175°C
- ◆ Excellent reverse recovery
- ◆ Low gate charge
- ◆ Low intrinsic capacitance
- ◆ ESD protected, HBM class 2
- ◆ Very low switching losses (required RC-snubber loss negligible under typical operating conditions)

### Typical applications

- ◆ EV charging
- ◆ PV inverters
- ◆ Switch mode power supplies
- ◆ Power factor correction modules
- ◆ Motor drives
- ◆ Induction heating

Part Number	Package	Marking
UF3SC120016K3S	TO-247-3L	UF3SC120016K3S



## Maximum Ratings

Parameter	Symbol	Test Conditions	Value	Units
Drain-source voltage	$V_{DS}$		1200	V
Gate-source voltage	$V_{GS}$	DC	-20 to +20	V
Continuous drain current <sup>1</sup>	$I_D$	$T_C = 25^\circ\text{C}$	107	A
		$T_C = 100^\circ\text{C}$	77	A
Pulsed drain current <sup>2</sup>	$I_{DM}$	$T_C = 25^\circ\text{C}$	350	A
Single pulsed avalanche energy <sup>3</sup>	$E_{AS}$	$L=15\text{mH}, I_{AS}=6.6\text{A}$	327	mJ
Power dissipation	$P_{tot}$	$T_C = 25^\circ\text{C}$	517	W
Maximum junction temperature	$T_{J,max}$		175	$^\circ\text{C}$
Operating and storage temperature	$T_J, T_{STG}$		-55 to 175	$^\circ\text{C}$
Max. lead temperature for soldering, 1/8" from case for 5 seconds	$T_L$		250	$^\circ\text{C}$

1. Limited by  $T_{J,max}$

2. Pulse width  $t_p$  limited by  $T_{J,max}$

3. Starting  $T_J = 25^\circ\text{C}$

## Thermal Characteristics

Parameter	Symbol	Test Conditions	Value			Units
			Min	Typ	Max	
Thermal resistance, junction-to-case	$R_{\theta JC}$			0.22	0.29	$^\circ\text{C}/\text{W}$

## Electrical Characteristics ( $T_J = +25^\circ\text{C}$ unless otherwise specified)

### Typical Performance - Static

Parameter	Symbol	Test Conditions	Value			Units
			Min	Typ	Max	
Drain-source breakdown voltage	$BV_{DS}$	$V_{GS}=0V, I_D=1mA$	1200			V
Total drain leakage current	$I_{DSS}$	$V_{DS}=1200V, V_{GS}=0V, T_J=25^\circ\text{C}$		1.2	300	$\mu\text{A}$
		$V_{DS}=1200V, V_{GS}=0V, T_J=175^\circ\text{C}$		3.7		
Total gate leakage current	$I_{GSS}$	$V_{DS}=0V, T_J=25^\circ\text{C}, V_{GS}=-20V / +20V$		4.5	$\pm 20$	$\mu\text{A}$
Drain-source on-resistance	$R_{DS(on)}$	$V_{GS}=12V, I_D=50A, T_J=25^\circ\text{C}$		16	21	m $\Omega$
		$V_{GS}=12V, I_D=50A, T_J=125^\circ\text{C}$		25		
		$V_{GS}=12V, I_D=50A, T_J=175^\circ\text{C}$		33		
Gate threshold voltage	$V_{G(th)}$	$V_{DS}=5V, I_D=10mA$	4	4.7	6	V
Gate resistance	$R_G$	$f=1\text{MHz}, \text{open drain}$		0.8	1.5	$\Omega$

### Typical Performance - Reverse Diode

Parameter	Symbol	Test Conditions	Value			Units
			Min	Typ	Max	
Diode continuous forward current <sup>1</sup>	$I_S$	$T_C=25^\circ\text{C}$			107	A
Diode pulse current <sup>2</sup>	$I_{S,pulse}$	$T_C=25^\circ\text{C}$			350	A
Forward voltage	$V_{FSD}$	$V_{GS}=0V, I_F=50A, T_J=25^\circ\text{C}$		1.47	2	V
		$V_{GS}=0V, I_F=50A, T_J=175^\circ\text{C}$		1.95		
Reverse recovery charge	$Q_{rr}$	$V_R=800V, I_F=80A, V_{GS}=-5V, R_{G,EXT}=5\Omega, di/dt=1750A/\mu\text{s}, T_J=25^\circ\text{C}$		605		nC
Reverse recovery time	$t_{rr}$	$T_J=25^\circ\text{C}$		66		ns
Reverse recovery charge	$Q_{rr}$	$V_R=800V, I_F=80A, V_{GS}=-5V, R_{G,EXT}=5\Omega, di/dt=1750A/\mu\text{s}, T_J=150^\circ\text{C}$		621		nC
Reverse recovery time	$t_{rr}$	$T_J=150^\circ\text{C}$		72		ns

## Typical Performance - Dynamic

Parameter	Symbol	Test Conditions	Value			Units
			Min	Typ	Max	
Input capacitance	$C_{iss}$	$V_{DS}=800V, V_{GS}=0V$ $f=100kHz$		7824		pF
Output capacitance	$C_{oss}$			216		
Reverse transfer capacitance	$C_{rss}$			3.1		
Effective output capacitance, energy related	$C_{oss(er)}$	$V_{DS}=0V$ to 800V, $V_{GS}=0V$		243		pF
Effective output capacitance, time related	$C_{oss(tr)}$	$V_{DS}=0V$ to 800V, $V_{GS}=0V$		540		pF
$C_{OSS}$ stored energy	$E_{oss}$	$V_{DS}=800V, V_{GS}=0V$		78		$\mu J$
Total gate charge	$Q_G$	$V_{DS}=800V, I_D=80A,$ $V_{GS} = -5V$ to 15V		218		nC
Gate-drain charge	$Q_{GD}$			24		
Gate-source charge	$Q_{GS}$			96		
Turn-on delay time	$t_{d(on)}$	$V_{DS}=800V, I_D=80A,$ Gate Driver = -5V to +15V, Turn-on $R_{G,EXT}=3.2\Omega,$ Turn-off $R_{G,EXT}=10\Omega$ Inductive Load,		44		ns
Rise time	$t_r$			75		
Turn-off delay time	$t_{d(off)}$			121		
Fall time	$t_f$			26		
Turn-on energy including $R_S$ energy <sup>4</sup>	$E_{ON}$			3290		
Turn-off energy including $R_S$ energy <sup>4</sup>	$E_{OFF}$			660		
Total switching energy including $R_S$ energy <sup>4</sup>	$E_{TOTAL}$	FWD: same device with $V_{GS} = -5V$ and $R_G = 10\Omega,$ RC snubber: $R_S=5\Omega$ and $C_S=680pF, T_J=25^\circ C$		3950		$\mu J$
Snubber $R_S$ energy during turn-on	$E_{RS\_ON}$			22		
Snubber $R_S$ energy during turn-off	$E_{RS\_OFF}$			76.5		
Turn-on delay time	$t_{d(on)}$			39		
Rise time	$t_r$			83		
Turn-off delay time	$t_{d(off)}$			128		
Fall time	$t_f$	FWD: same device with $V_{GS} = -5V$ and $R_G = 10\Omega,$ RC snubber: $R_S=5\Omega$ and $C_S=680pF, T_J=150^\circ C$		29		ns
Turn-on energy including $R_S$ energy <sup>4</sup>	$E_{ON}$			3353		
Turn-off energy including $R_S$ energy <sup>4</sup>	$E_{OFF}$			670		
Total switching energy including $R_S$ energy <sup>4</sup>	$E_{TOTAL}$			4023		
Snubber $R_S$ energy during turn-on	$E_{RS\_ON}$			19		
Snubber $R_S$ energy during turn-off	$E_{RS\_OFF}$			72		

4. The switching performance are evaluated with a RC snubber circuit as shown in Figure 24.

## Typical Performance - Dynamic (continued)

Parameter	Symbol	Test Conditions	Value			Units
			Min	Typ	Max	
Turn-on delay time	$t_{d(on)}$	$V_{DS}=800V$ , $I_D=80A$ , Gate Driver = -5V to +15V, Turn-on $R_{G,EXT}=3.2\Omega$ , Turn-off $R_{G,EXT}=10\Omega$ Inductive Load, FWD: UJ3D1250K $T_J=25^\circ C$		40		ns
Rise time	$t_r$			63		
Turn-off delay time	$t_{d(off)}$			119		
Fall time	$t_f$			14		
Turn-on energy	$E_{ON}$			2102		$\mu J$
Turn-off energy	$E_{OFF}$			400		
Total switching energy	$E_{TOTAL}$			2502		
Turn-on delay time	$t_{d(on)}$	$V_{DS}=800V$ , $I_D=80A$ , Gate Driver = -5V to +15V, Turn-on $R_{G,EXT}=3.2\Omega$ , Turn-off $R_{G,EXT}=10\Omega$ Inductive Load, FWD: UJ3D1250K $T_J=150^\circ C$		43		ns
Rise time	$t_r$			72		
Turn-off delay time	$t_{d(off)}$			129		
Fall time	$t_f$			14		
Turn-on energy	$E_{ON}$			2315		$\mu J$
Turn-off energy	$E_{OFF}$			440		
Total switching energy	$E_{TOTAL}$			2755		

## Typical Performance Diagrams

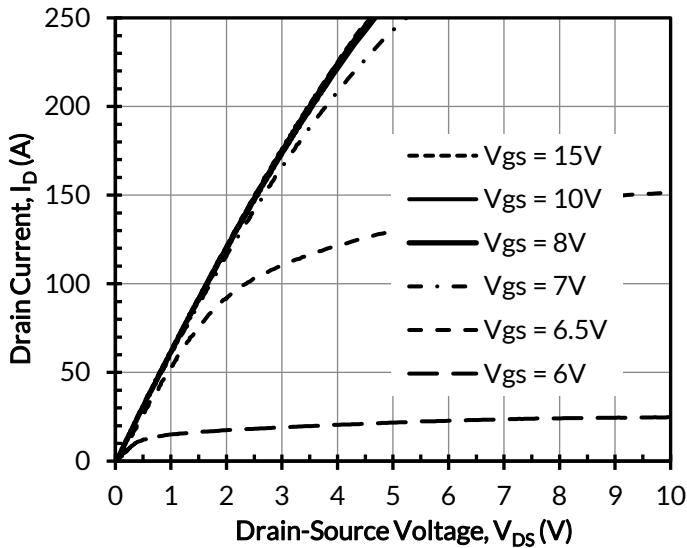

Figure 1. Typical output characteristics at  $T_J = -55^\circ\text{C}$ ,  $t_p < 250\mu\text{s}$

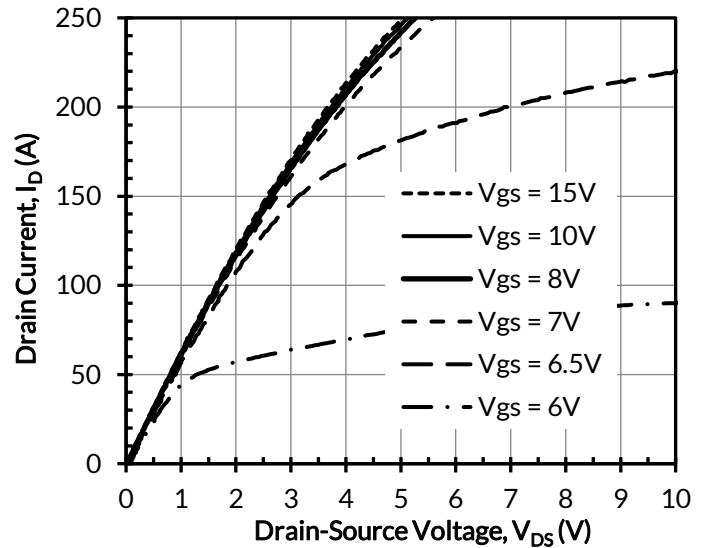

Figure 2. Typical output characteristics at  $T_J = 25^\circ\text{C}$ ,  $t_p < 250\mu\text{s}$

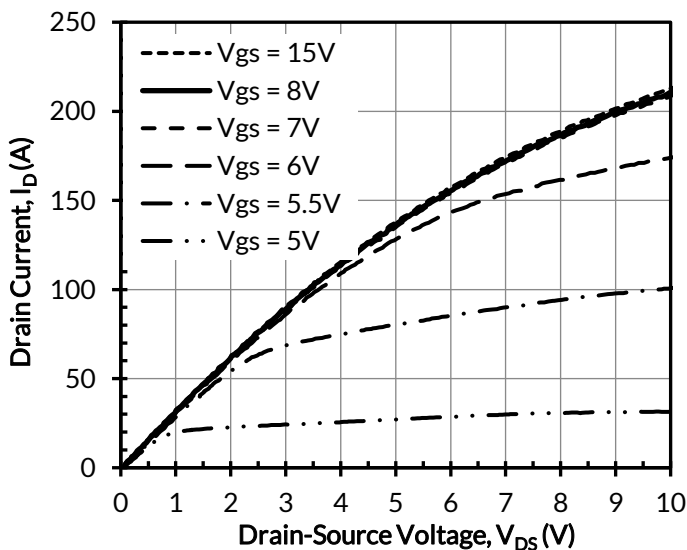

Figure 3. Typical output characteristics at  $T_J = 175^\circ\text{C}$ ,  $t_p < 250\mu\text{s}$

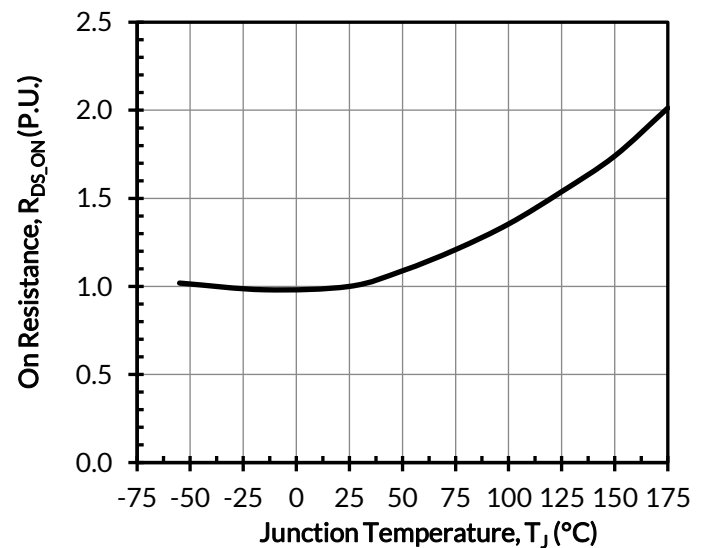

Figure 4. Normalized on-resistance vs. temperature at  $V_{GS} = 12\text{V}$  and  $I_D = 50\text{A}$

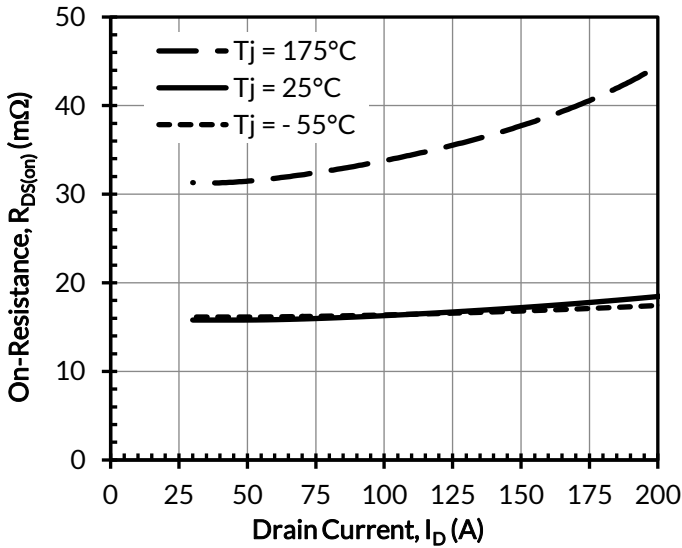

Figure 5. Typical drain-source on-resistances at  $V_{GS} = 12\text{V}$

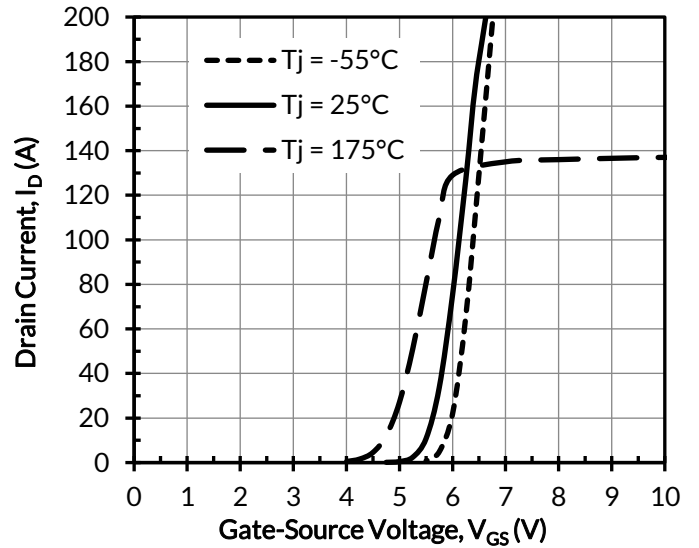

Figure 6. Typical transfer characteristics at  $V_{DS} = 5\text{V}$

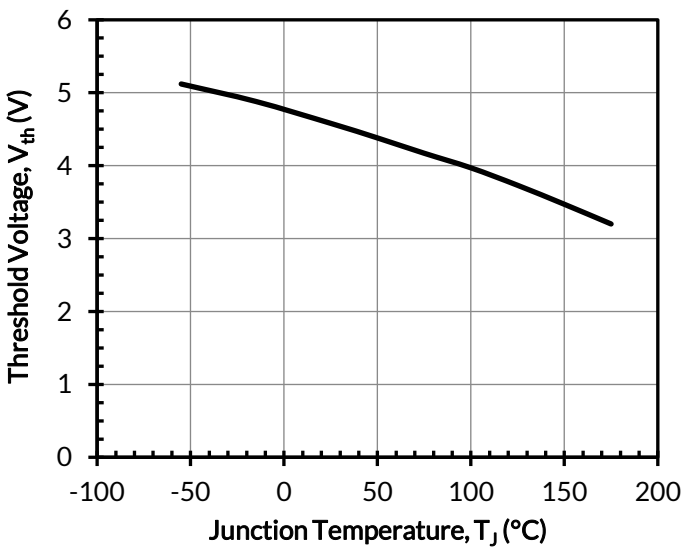

Figure 7. Threshold voltage vs. junction temperature at  $V_{DS} = 5\text{V}$  and  $I_D = 10\text{mA}$

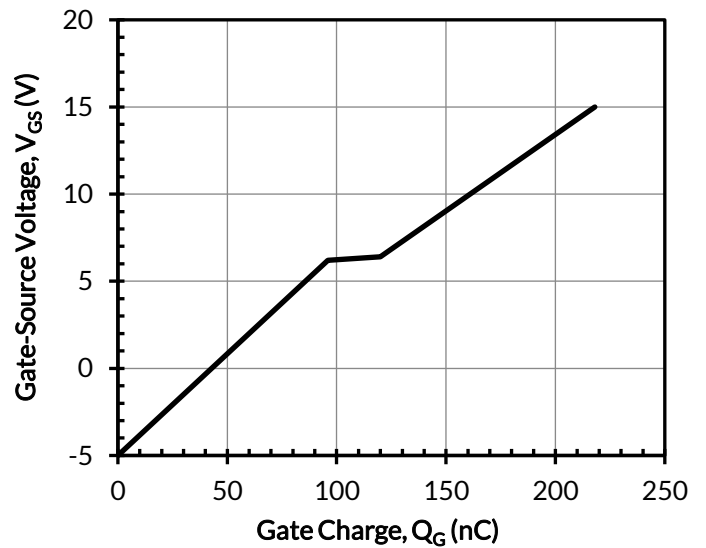

Figure 8. Typical gate charge at  $V_{DS} = 800\text{V}$  and  $I_D = 80\text{A}$

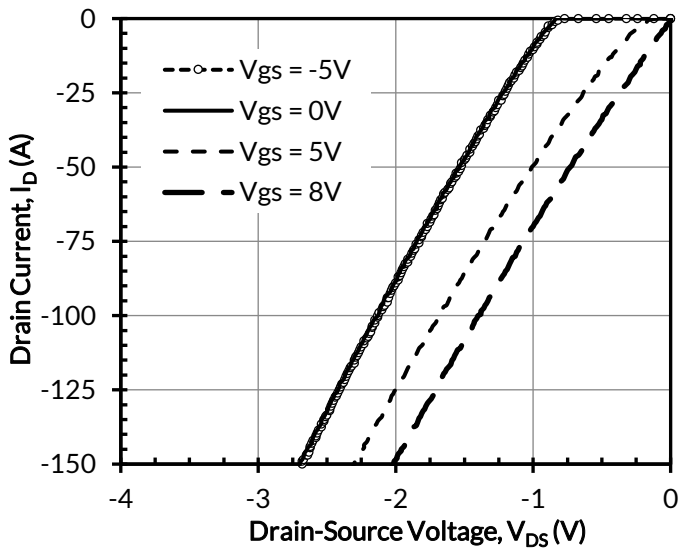

Figure 9. 3rd quadrant characteristics at  $T_j = -55^\circ\text{C}$

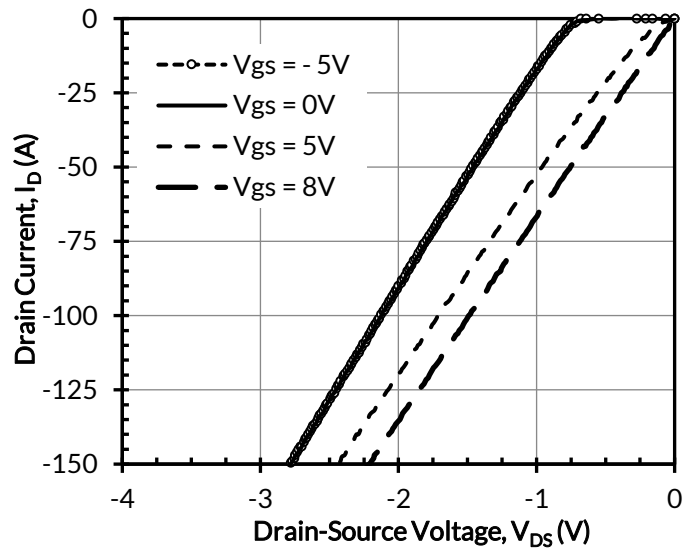

Figure 10. 3rd quadrant characteristics at  $T_j = 25^\circ\text{C}$

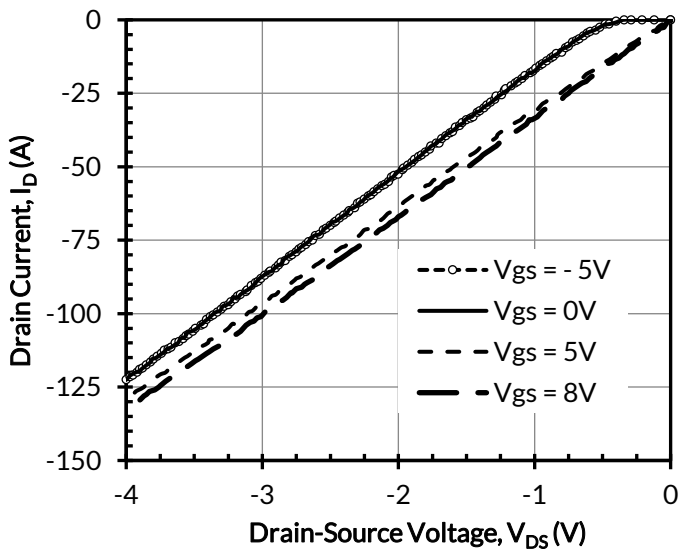

Figure 11. 3rd quadrant characteristics at  $T_j = 175^\circ\text{C}$

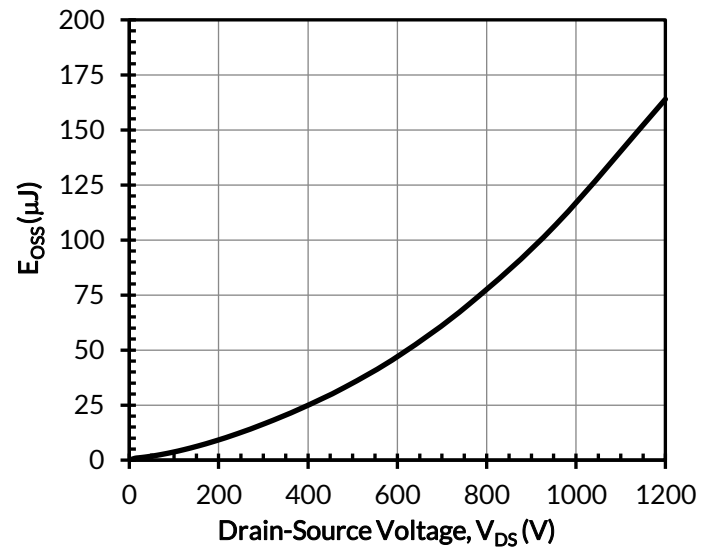

Figure 12. Typical stored energy in  $C_{OSS}$  at  $V_{GS} = 0\text{V}$



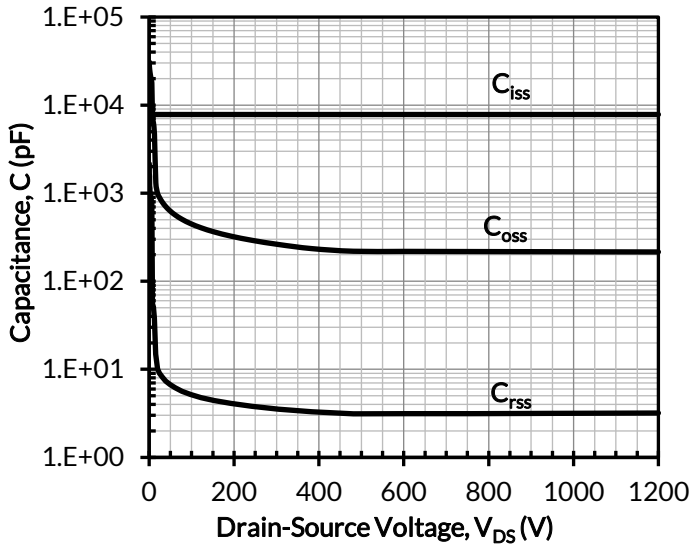

Figure 13. Typical capacitances at  $f = 100\text{kHz}$  and  $V_{GS} = 0\text{V}$

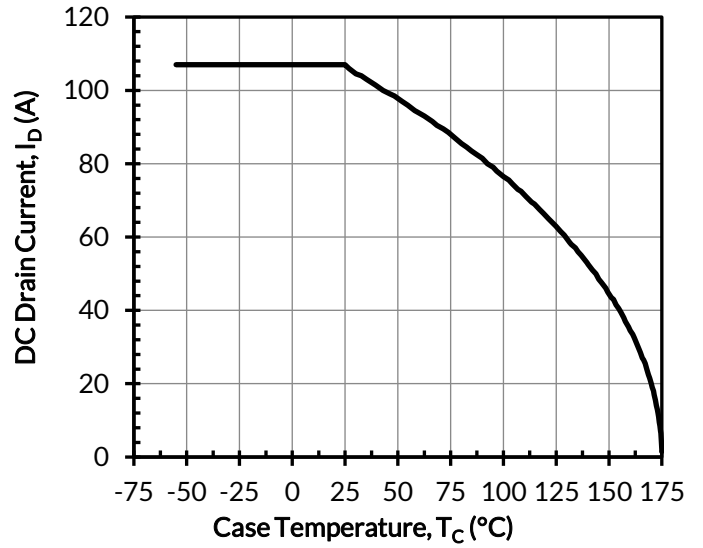

Figure 14. DC drain current derating

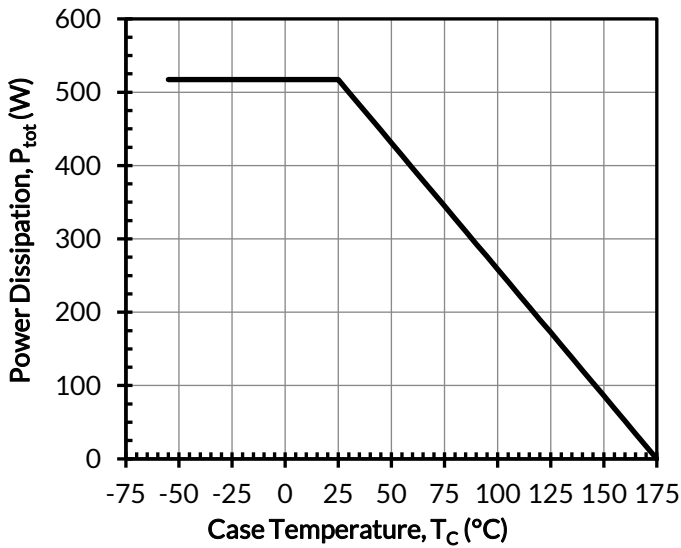

Figure 15. Total power dissipation

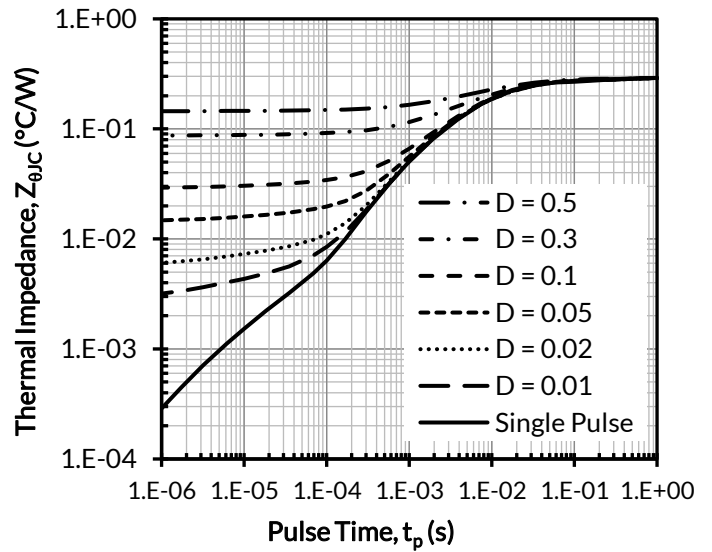

Figure 16. Maximum transient thermal impedance

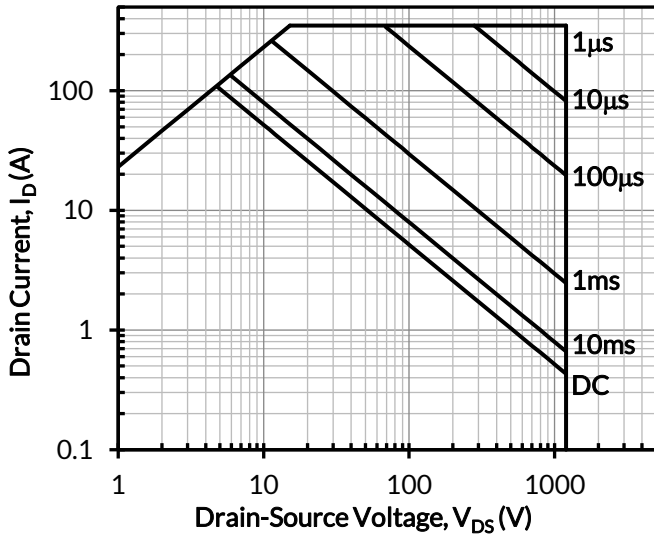

Figure 17. Safe operation area at  $T_C = 25^\circ\text{C}$ ,  $D = 0$ , Parameter  $t_p$

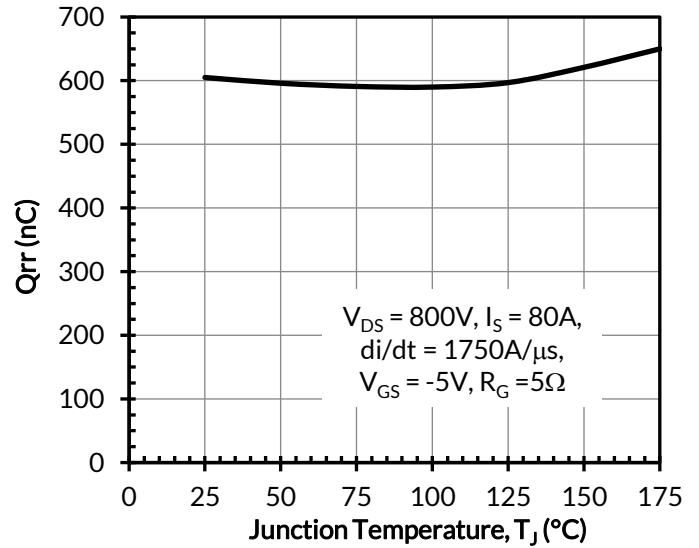
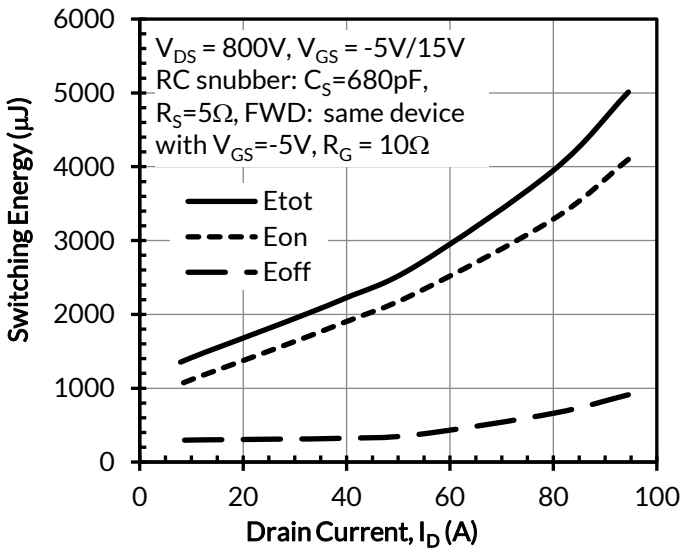
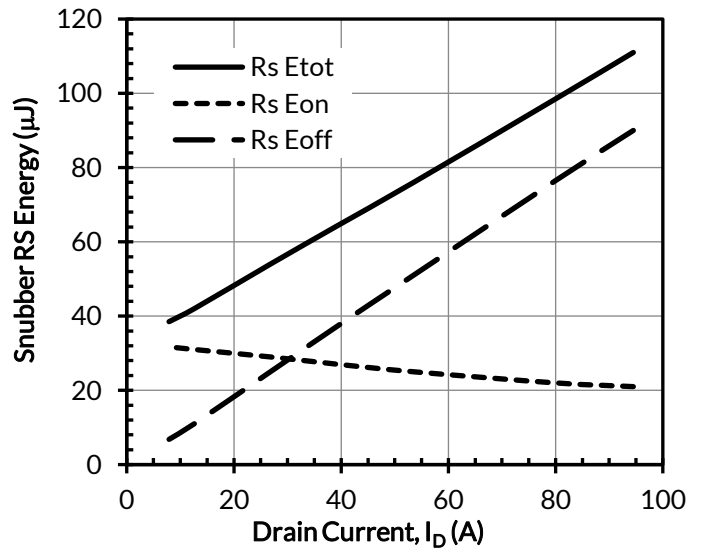

Figure 18. Reverse recovery charge  $Q_{rr}$  vs. junction temperature



(a)



(b)

Figure 19. Clamped inductive switching energy (a) and RC snubber energy loss (b) vs. drain current at  $T_J = 25^\circ\text{C}$ , turn-on  $R_{G\_EXT} = 3.2\Omega$ , and turn-off  $R_{G\_EXT} = 10\Omega$

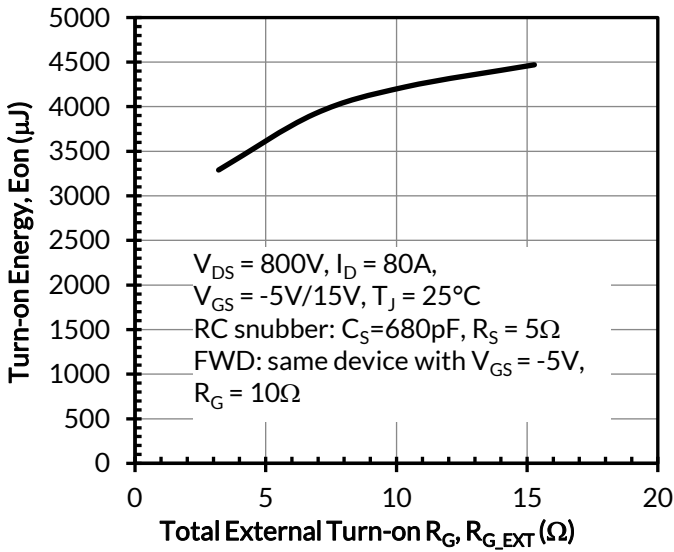

(a)

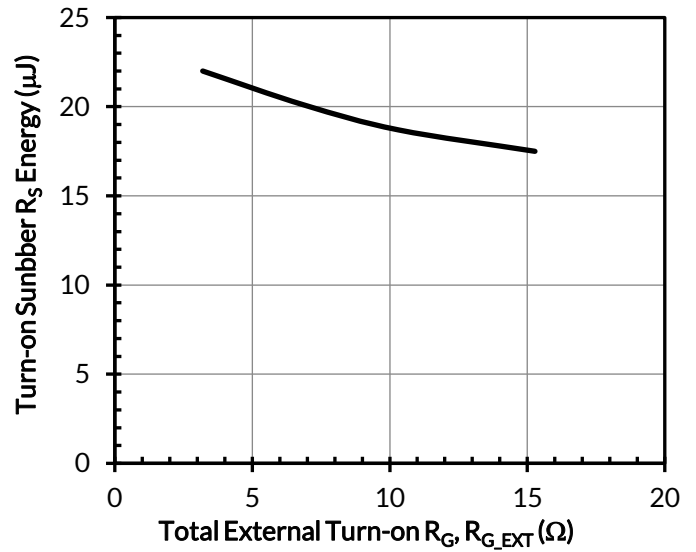

(b)

Figure 20. Clamped inductive switching turn-on energy including RC snubber energy loss (a) and RC snubber energy loss (b) as a function of total external turn-on gate resistor  $R_{G\_EXT}$

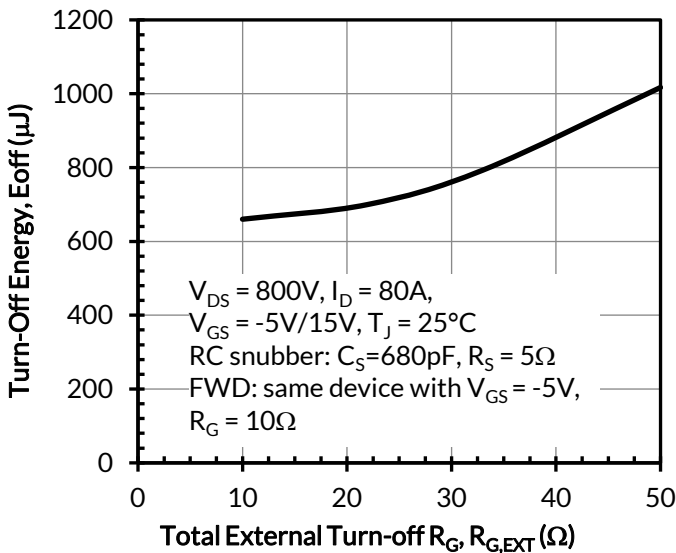

(a)

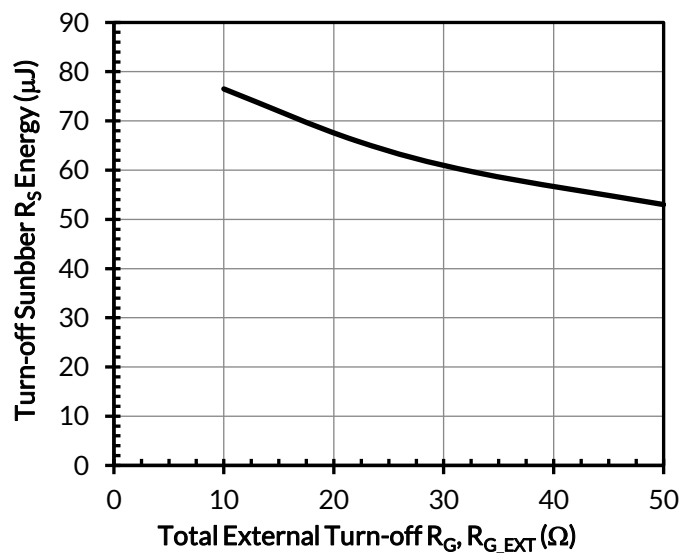

(b)

Figure 21. Clamped inductive switching turn-off energy including RC snubber energy loss (a) and RC snubber energy loss (b) as a function of total external turn-off gate resistor  $R_{G\_EXT}$

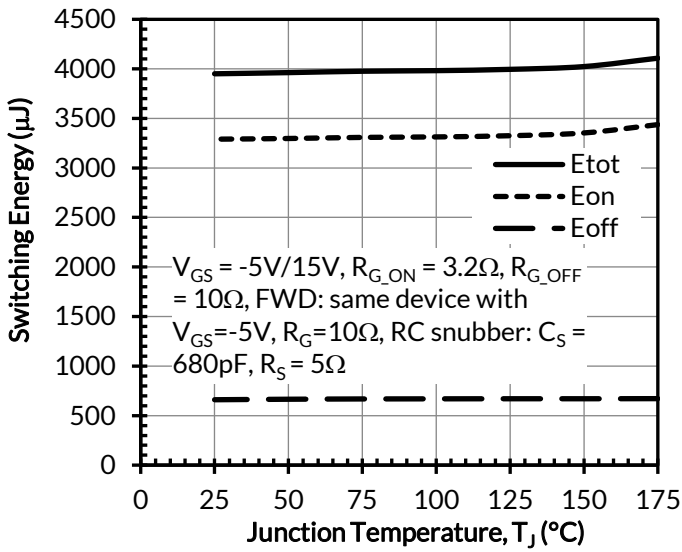

(a)

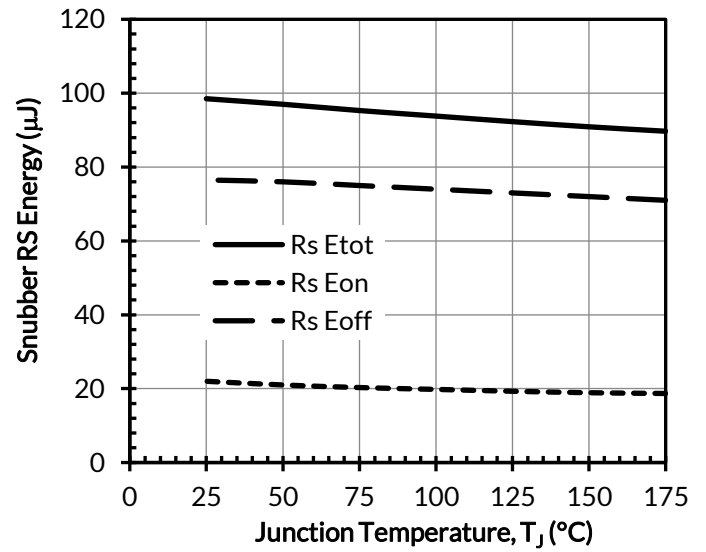

(b)

Figure 22. Clamped inductive switching energy including RC snubber energy loss (a) and RC snubber energy loss (b) as a function of junction temperature at  $V_{DS} = 800V$  and  $I_D = 80A$

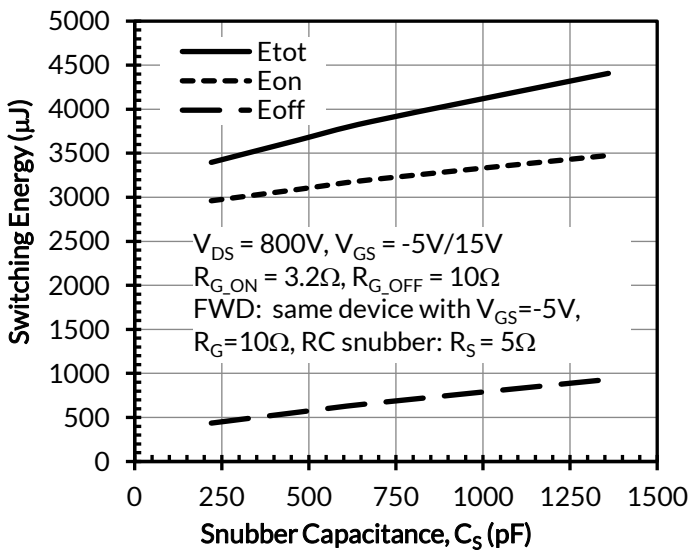

(a)

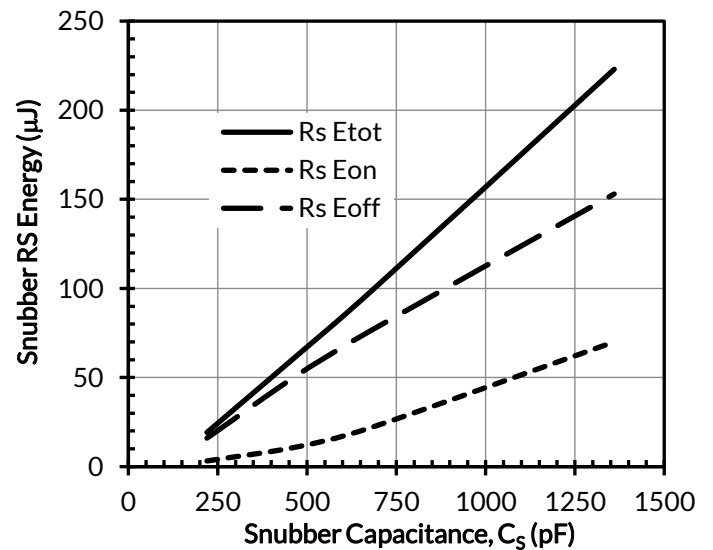

(b)

Figure 23. Clamped inductive switching energy including RC snubber energy loss (a) and RC snubber energy loss (b) as a function of snubber capacitance at  $I_D = 80A$  and  $T_J = 25^\circ C$

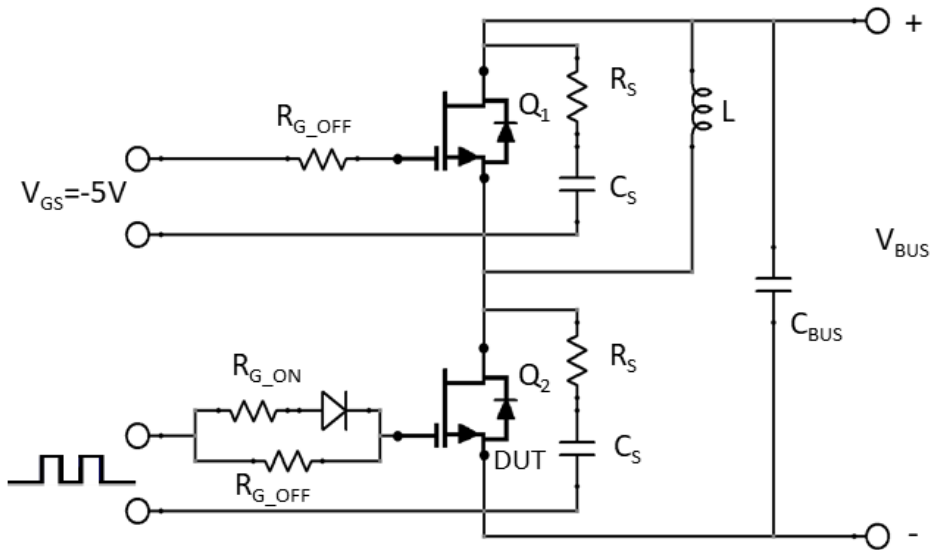

Figure 24. Clamped inductive load switching test circuit  
 An RC snubber ( $R_S = 5\Omega$  and  $C_S = 680\text{pF}$ ) is required to improve the turn-off waveforms.

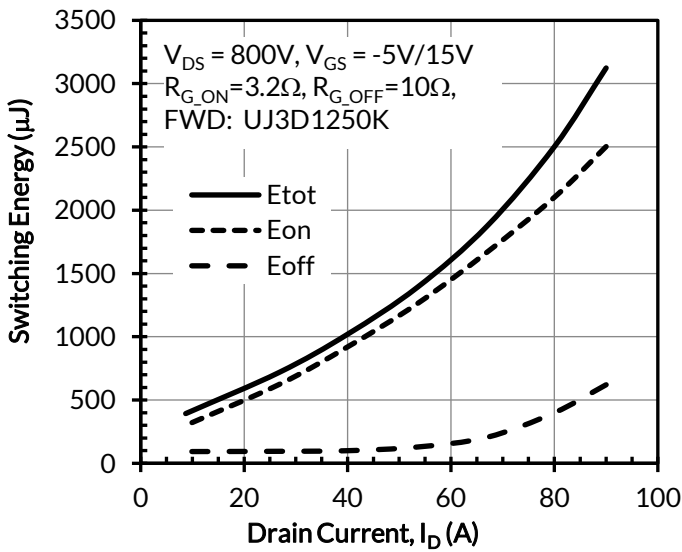

Figure 25. Clamped inductive switching energy vs. drain current without RC snubber at  $T_J = 25^\circ\text{C}$

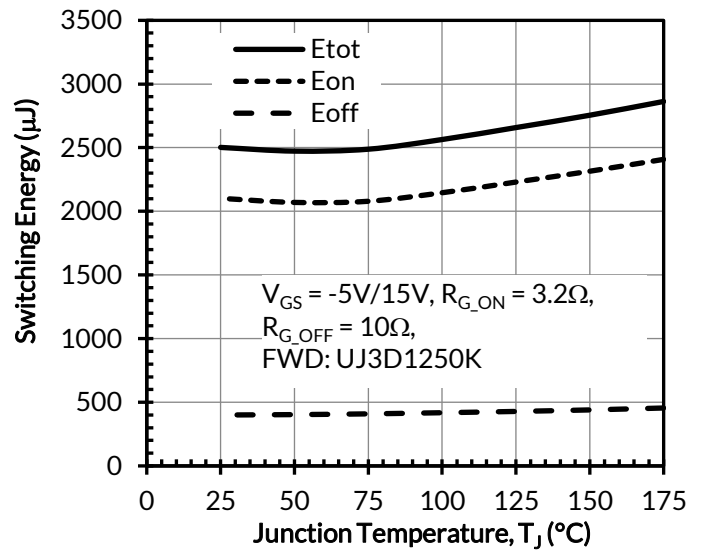

Figure 26. Clamped inductive switching energy vs. junction temperature without RC snubber at  $V_{DS} = 800\text{V}$  and  $I_D = 80\text{A}$

## Applications Information

SiC FETs are enhancement-mode power switches formed by a high-voltage SiC depletion-mode JFET and a low-voltage silicon MOSFET connected in series. The silicon MOSFET serves as the control unit while the SiC JFET provides high voltage blocking in the off state. This combination of devices in a single package provides compatibility with standard gate drivers and offers superior performance in terms of low on-resistance ( $R_{DS(on)}$ ), output capacitance ( $C_{oss}$ ), gate charge ( $Q_G$ ), and reverse recovery charge ( $Q_{rr}$ ) leading to low conduction and switching losses. The SiC FETs also provide excellent reverse conduction capability eliminating the need for an external anti-parallel diode.

Like other high performance power switches, proper PCB layout design to minimize circuit parasitics is strongly recommended due to the high  $dv/dt$  and  $di/dt$  rates. An external gate resistor is recommended when the FET is working in the diode mode in order to achieve the optimum reverse recovery performance. For more information on SiC FET operation, see [www.unitedsic.com](http://www.unitedsic.com).

## Disclaimer

UnitedSiC reserves the right to change or modify any of the products and their inherent physical and technical specifications without prior notice. UnitedSiC assumes no responsibility or liability for any errors or inaccuracies within.

Information on all products and contained herein is intended for description only. No license, express or implied, to any intellectual property rights is granted within this document.

UnitedSiC assumes no liability whatsoever relating to the choice, selection or use of the UnitedSiC products and services described herein.

# Mouser Electronics

Authorized Distributor

Click to View Pricing, Inventory, Delivery & Lifecycle Information:

[Qorvo:](#)

[UF3SC120016K3S](#)