

# T Series Subminiature Toggle Switches

## Features/Benefits

- Compact size—small footprint
- Single and double pole models
- PC and panel mount options available
- RoHS compliant models available

## Typical Applications

- Hand-held telecommunications
- Instrumentation
- Medical equipment

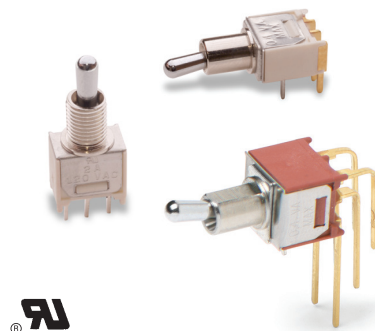

## Specifications

CONTACT RATING: B contact material: 0.4 VA max. @ 20 V AC or DC max. Q contact material (TX01 models): 3 AMPS @ 120 V AC or 28 V DC. All other models: 2 AMPS @ 120 V AC or 28 V DC. See page F-42 for additional ratings.

ELECTRICAL LIFE: TX01 models: 60,000 make-and-break cycles at full load. All other models: 30,000 cycles.

CONTACT RESISTANCE: Below 20 m Ω typ. initial @ 2-4 V DC, 100 mA, for both silver and gold plated contacts.

INSULATION RESISTANCE: 10<sup>9</sup> Ω min.

DIELECTRIC STRENGTH: 1000 Vrms min. @ sea level.

OPERATING TEMPERATURE: -30°C to 85°C.

SOLDERABILITY: Per MIL-STD-202F method 208D, or EIA RS-186E method 9 (1 hour steam aging).

**NOTE:** Any models supplied with P, R, Q, B or G contact material are RoHS compliant and compatible.

**NOTE:** Specifications and materials listed above are for switches with standard options. For information on specific and custom switches, consult Customer Service Center.

## Materials

CASE: Glass filled nylon 6/6, flame retardant, heat stabilized or diallyl phthalate (DAP), (UL 94V-0) or glass filled nylon 4/6, flame retardant, heat stabilized.

ACTUATOR: Brass, chrome plated.

BUSHING: Brass, nickel plated.

HOUSING: Stainless steel.

SWITCH SUPPORT: Brass, matte-tin plated.

END CONTACTS: B contact material: Copper alloy, with gold plate over nickel plate. Q contact material: Coin silver, silver plated. See above for additional contact materials.

CENTER CONTACTS & TERMINALS: B contact material: Copper alloy, with gold plate over nickel plate. Q contact material: Copper alloy, silver plated. See page F-42 for additional contact materials.

TERMINAL SEAL: Epoxy.

HARDWARE: Nut & Locking Ring: Brass, nickel plated.

Lockwasher: Steel, nickel plated. Additional hardware available separately, see Section N.

## Build-A-Switch

To order, simply select desired option from each category and place in the appropriate box. Available options are shown and described on pages F-38 thru F-42. For additional options not shown in catalog, consult Customer Service Center. All models have epoxy terminal seal and are compatible with all “bottom-wash” PCB cleaning methods.

### Switch Function

- T101** SPDT On-None-On
- T102** SPDT Off-None-On
- T103** SPDT On-Off-On
- T105** SPDT Mom.-Off-Mom.
- T107** SPDT On-Off-Mom.
- T108** SPDT On-None-Mom.
- T201** DPDT On-None-On
- T203** DPDT On-Off-On
- T205** DPDT Mom.-Off-Mom.
- T207** DPDT On-Off-Mom.
- T208** DPDT On-None-Mom.
- T211** DPDT On-On-On.

### Actuator

- P3** Flatted, anti-rotation, .490" high
- S** .370" high
- K** Locking lever, round tip
- L1** .640" high
- M1** .220" high
- S1** .410" high
- M** .210" high
- L** .290" high

### Bushing

- H** .220" high, threaded, flat
- H9** .220" high, unthreaded, flat
- CF** Splashproof, .310" high, threaded, flat
- D9** .260" high, unthreaded, keyway
- T** .310" high, threaded, flat
- T9** .310" high, unthreaded, flat
- TD** .260" high, threaded, keyway
- TK** .310" high, threaded, keyway
- Y** .220" high, threaded, keyway
- Y9** .220" high, unthreaded, keyway

### Terminations

- A** Right angle, PC thru-hole
- AV** Vertical right angle, PC thru-hole
- C** PC Thru-hole
- V3** Vertical mount V-bracket
- Z** Solder lug
- W** Wire wrap

### Seal

- E** Epoxy

### Contact Material

- B** Gold
- P** Gold, matte tin
- Q** Silver
- G** Gold over silver
- R** Gold over silver, matte-tin

# T Series Subminiature Toggle Switches

## SWITCH FUNCTION

NO. POLES	MODEL NO.	SWITCH FUNCTION			CONNECTED TERMINALS			SCHEMATIC
		POS. 1	POS. 2	POS. 3	POS. 1	POS. 2	POS. 3	
SP	<b>T101</b>	ON	NONE	ON	2-3	N/A	2-1	
	<b>T103</b>	ON	OFF	ON	2-3	OPEN	2-1	
	<b>T105</b>	MOM.	OFF	MOM.				
	<b>T107</b>	ON	OFF	MOM.				
	<b>T108</b>	ON	NONE	MOM.	2-3	NA	2-1	
<b>T102</b>	OFF	NONE	ON	OPEN	N/A	3-1		

### SPDT

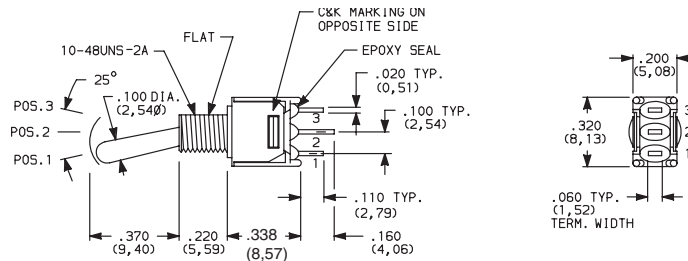

Part number shown: T101SHZQE

NO. POLES	MODEL NO.	SWITCH FUNCTION			CONNECTED TERMINALS			SCHEMATIC
		POS. 1	POS. 2	POS. 3	POS. 1	POS. 2	POS. 3	
DP	<b>T201</b>	ON	NONE	ON	2-3,5-6	N/A	2-1,5-4	
	<b>T203</b>	ON	OFF	ON	2-3,5-6	OPEN	2-1,5-4	
	<b>T205</b>	MOM.	OFF	MOM.				
	<b>T208</b>	ON	NONE	MOM.	2-3,5-6	N/A	2-1,5-4	
	<b>T211*</b>	ON	ON	ON	2-3,5-6	2-3,5-4	2-1,5-4	

### DPDT

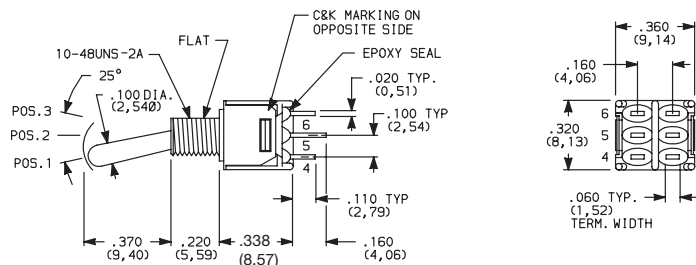

Terminal Nos.  
For Reference Only

Part number shown: T201SHZQE

MOM. = Momentary  
\* Wiring for 3-way switch

All models with all options when ordered with G, L, R or Q contact material.

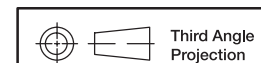

Dimensions are shown: Inches (mm)  
Specifications and dimensions subject to change



15 Jan 21

# T Series Subminiature Toggle Switches

## ACTUATOR

**M** .210" HIGH

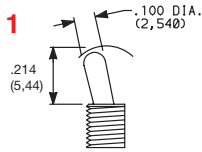

Standard with A, AV or V3 terminations.

**S** .370" HIGH

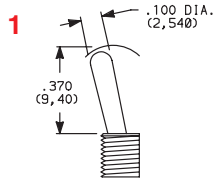

Standard with Z, C or W terminations.

**M1** .220" HIGH  
(with "T" bushing)

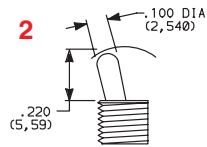

**S1** .410" HIGH  
(with "T" bushing)

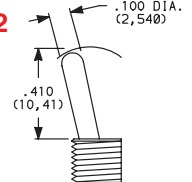

**L** .290" HIGH

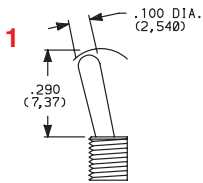

**L1** .640" HIGH

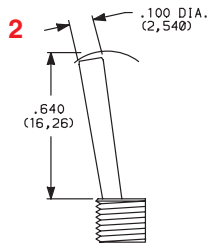

**P3** ANTI-ROTATION, FLATTED,  
.450" HIGH

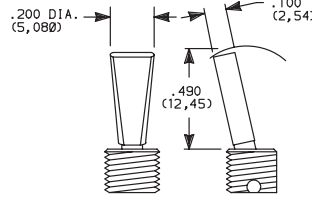

Available with T & T9 bushings only.  
Dress nut part number 709901201  
supplied standard with threaded bushing.

<sup>1</sup> Actuator shown with standard H bushing. Subtract .040 (1.02) for TD and D9 bushings, subtract .090 (2.29) for T, T9, TK, K9 & CF bushings.

<sup>2</sup> Actuators shown with T, T9, TK & CF bushings, add .050 (1.27) for TD and D9 bushings, add .090 (2.29) for H, H9, Y & Y9 bushings.

All actuators have chrome finish (except K).

## K LOCKING LEVER

### Locking Positions

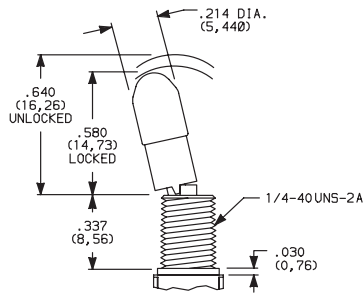

-01 & -02 Models  
2 Position lock

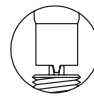

-03 & -11 Models  
3 Position lock



-08 Models  
1 Position lock

K actuators have natural aluminum finish.

Keyway on right side. To prevent accidental actuation, toggles must be lifted before being actuated. When released, toggles again lock in place. Overtightening mounting nut may cause actuator to bind.

Not available with CF bushing option.

Bushing option code not required. Not available with TX05 & TX07 models.

## BUSHING

**H** .220" HIGH THREADED, FLAT

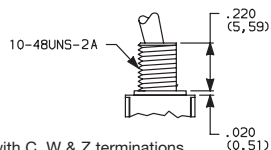
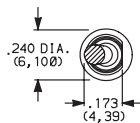

H standard with C, W & Z terminations.

H9 standard with A, AV & V3 terminations.

**Y** .220" HIGH THREADED, KEYWAY

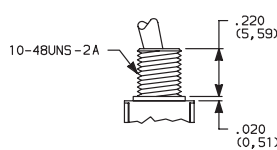
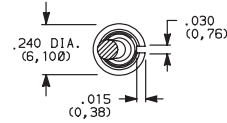

**Y9** .220" HIGH UNTHREADED, KEYWAY

**T** .310" HIGH THREADED, FLAT

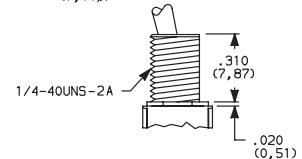
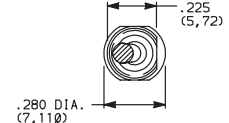

**T9** .310" HIGH UNTHREADED, FLAT

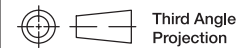

Third Angle Projection

Dimensions are shown: Inches (mm)  
Specifications and dimensions subject to change

# T Series Subminiature Toggle Switches

## BUSHING

**TK** .310" HIGH THREADED, KEYWAY

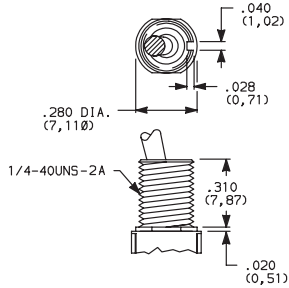

**TD** .260" HIGH THREADED, KEYWAY

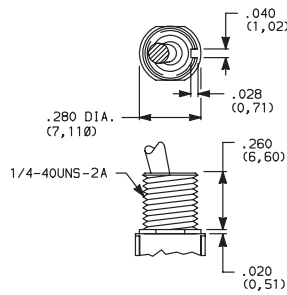

**D9** .260" HIGH UNTHREADED, KEYWAY

**CF** SPLASHPROOF, .310" HIGH THREADED, FLAT

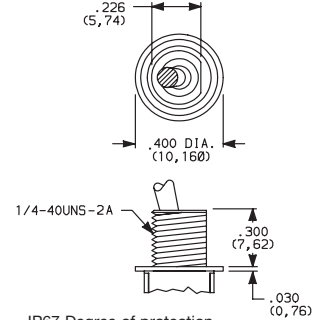

IP67 Degree of protection.  
Internal o-ring actuator seal and  
external bushing seal washer standard.

Not available with K locking lever option.

### 10-48 BUSHING

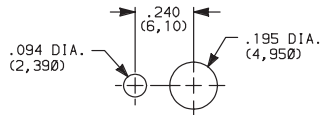

With Standard Locking Ring

### PANEL MOUNTING

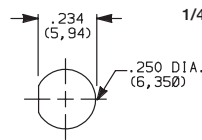

Without Locking Ring

### 1/4 IN. BUSHING

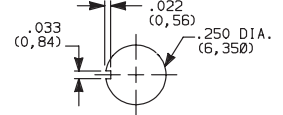

Without Locking Ring

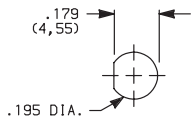

Without Locking Ring

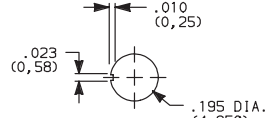

Without Locking Ring

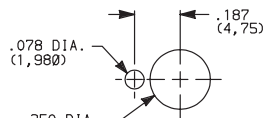

With Small Locking Ring

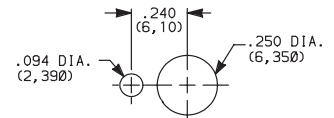

With Standard Locking Ring

## TERMINATIONS

**Z** SOLDER LUG

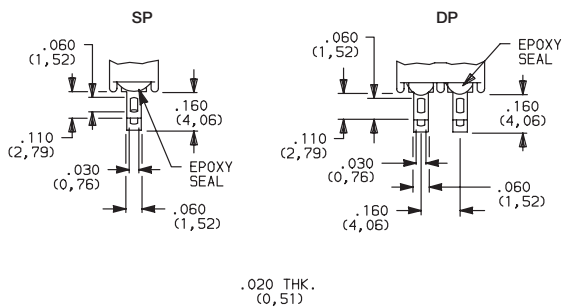

**C** PC THRU-HOLE

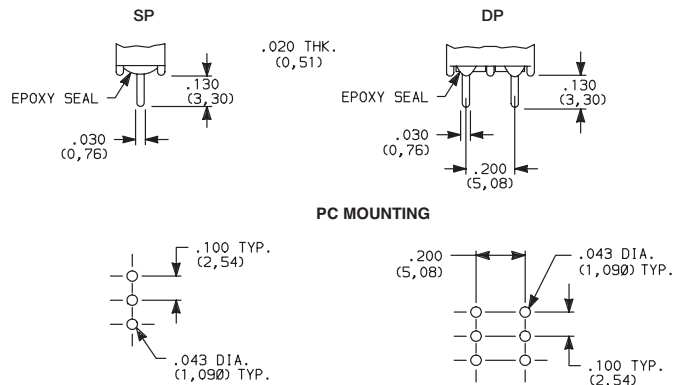

T102 - omit center hole.

Not available with P or R contact materials.

**W** WIRE WRAP

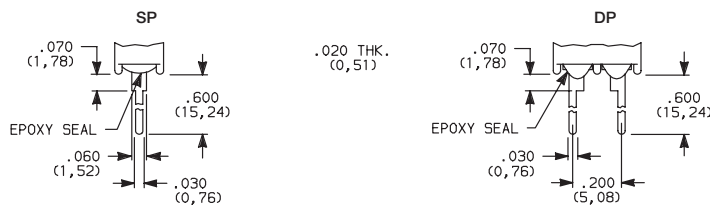

T

Toggle



Third Angle  
Projection

Dimensions are shown: Inches (mm)  
Specifications and dimensions subject to change

# T Series Subminiature Toggle Switches

## TERMINATIONS

### A RIGHT ANGLE, PC THRU-HOLE

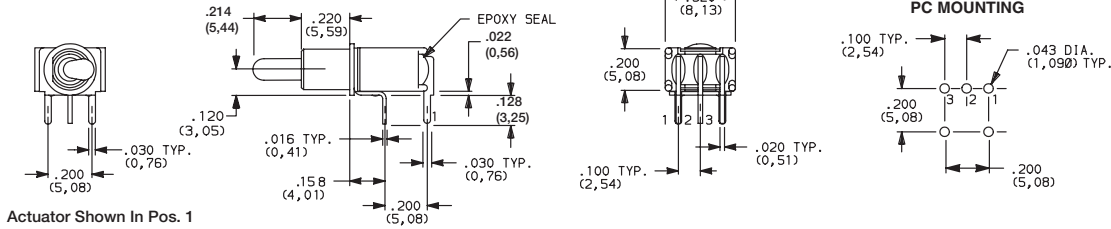

Actuator Shown In Pos. 1

Not available with T102 model.



**T101MH9ABE**  
Horizontal Actuation  
**SPDT**

### A RIGHT ANGLE, PC THRU-HOLE

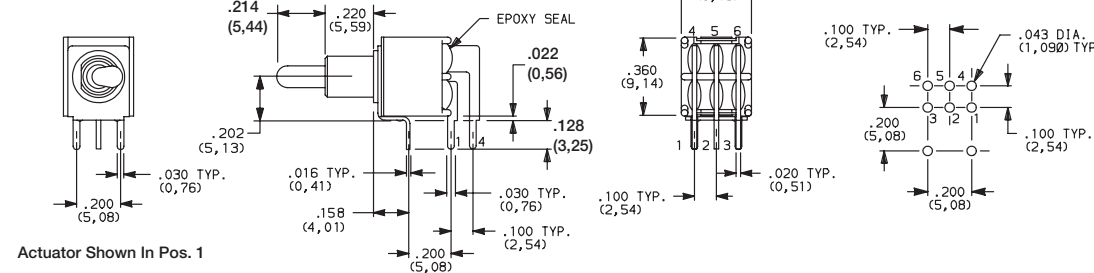

Actuator Shown In Pos. 1

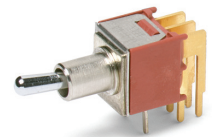

**T201MH9ABE**  
Horizontal Actuation  
**DPDT**

### AV VERTICAL RIGHT ANGLE, PC THRU-HOLE

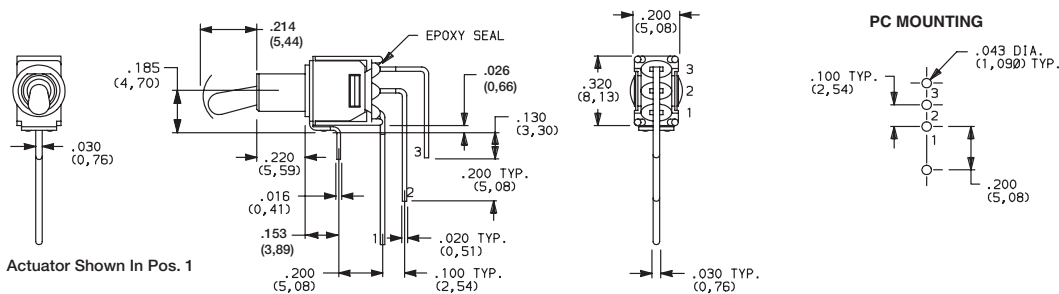

Actuator Shown In Pos. 1

T102 Models: Omit terminal 2

**NOTE:** Terminal bend radii and lead-in manufacturing option.

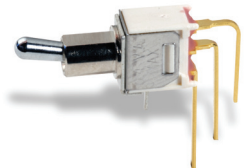

**T101MH9AVBE**  
Vertical Actuation  
**SPDT**

### AV VERTICAL RIGHT ANGLE, PC THRU-HOLE

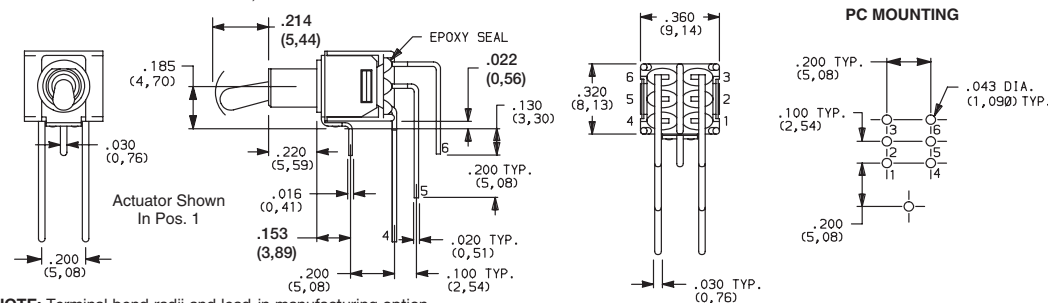

Actuator Shown In Pos. 1

**NOTE:** Terminal bend radii and lead-in manufacturing option.

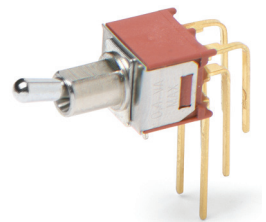

**T201MH9AVBE**  
Vertical Actuation  
**DPDT**

### V3 VERTICAL MOUNT, V-BRACKET

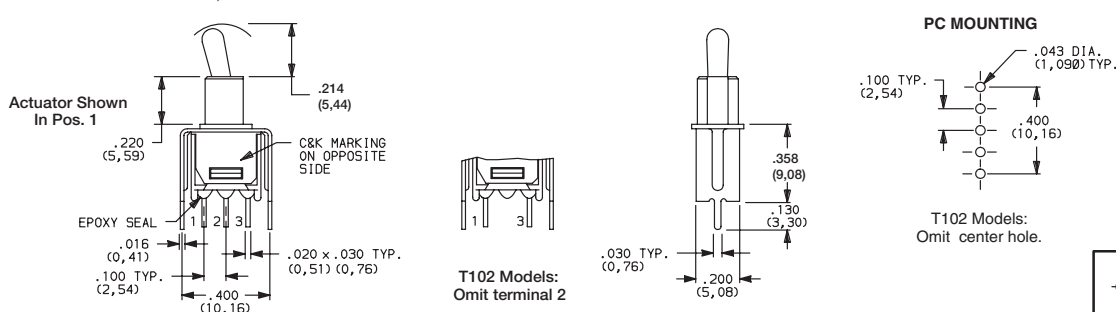

Actuator Shown In Pos. 1

C&K MARKING ON OPPOSITE SIDE

T102 Models: Omit terminal 2



**T101MH9V3BE**  
**SPDT**



Dimensions are shown: Inches (mm)  
Specifications and dimensions subject to change

# T Series Subminiature Toggle Switches

## TERMINATIONS

**V3** VERTICAL MOUNT, V-BRACKET



T201MH9V3BE  
DPDT

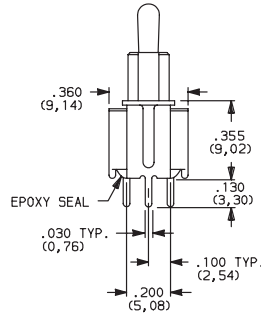
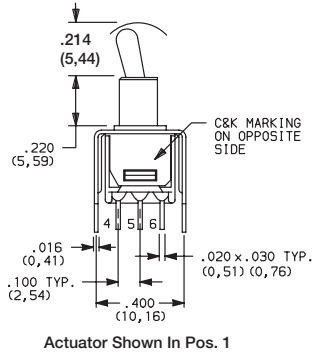

PC MOUNTING

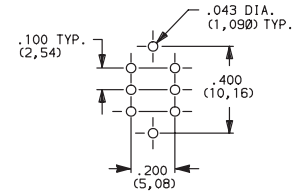

## CONTACT MATERIAL

OPTION CODE	CONTACT MATERIAL	TERMINAL PLATING	RATINGS	
<b>B</b>	GOLD 1	GOLD 1	LOW LEVEL/ DRY CIRCUIT	0.4 VA MAX. @ 20 V AC OR DC MAX.
<b>P</b>		MATTE-TIN 6		
<b>Q</b>	SILVER 4,5	SILVER 5	POWER	TX01 MODELS: 3 AMPS @ 120 V AC OR 28 V DC. ALL OTHER MODELS: 2 AMPS @ 120 V AC OR 28 V DC.
<b>G</b>	GOLD OVER SILVER 2,3	GOLD 3	LOW LEVEL/DRY CIRCUIT OR POWER	TX01 MODELS: 0.4 VA MAX @ 20 V AC OR DC MAX. OR 3 AMPS @ 120 V AC OR 28 V DC. ALL OTHER MODELS: 0.4 VA MAX @ 20 V AC OR DC MAX. OR 2 AMPS @ 120 V AC OR 28 V DC.
<b>R</b>		MATTE-TIN 6		

\* Note: See Technical Data section of this catalog for RoHS compliant and compatible definitions and specifications.

1 CONTACTS & TERMINALS: Copper alloy, with gold plate over nickel plate.

2 END CONTACTS: Coin silver, with gold plate over nickel plate.

3 CENTER CONTACTS & ALL TERMINALS: Copper alloy, with gold plate over nickel plate.

4 END CONTACTS: Coin silver, silver plated.

5 CENTER CONTACT & ALL TERMINALS: Copper alloy, silver plated.

6 TERMINALS: Copper alloy, with matte-tin over nickel plate.

All models with all options when ordered with R, G, or Q contact material.

B contact material standard with A, AV, V3 & W terminations.

Q contact material standard with C & Z terminations.

## SEAL

**E** EPOXY SEAL

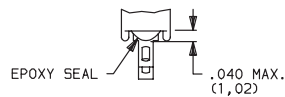

## AVAILABLE HARDWARE

**759D02000** SEALING BOOT



**F**

Toggle

\* Note: For use with S1 actuator style when combined with T, TK, and CF bushings.

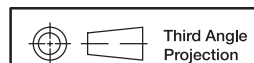
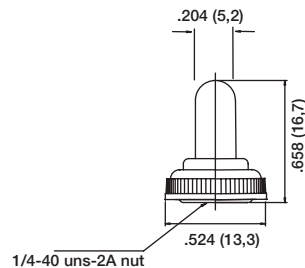

Dimensions are shown: Inches (mm)  
Specifications and dimensions subject to change



15 Jan 21