

## Product Summary

$V_{(BR)DSS}$	$R_{DS(on)MAX}$	$I_D$
20V	25mΩ@4.5V	6A
	32mΩ@2.5V	

## Feature

- Advanced trench process technology
- High density cell design for ultra low on-resistance

## Application

- Battery protection
- Switching application

## Package



SOT-23-6L

## Circuit diagram

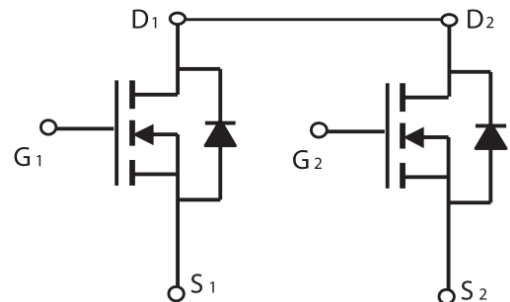

## Marking

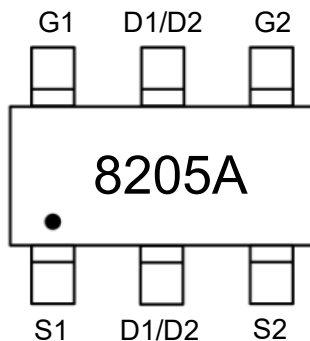

**Absolute maximum ratings (Ta=25°C unless otherwise noted)**

Parameter	Symbol	Value	Unit
Drain-Source Voltage	$V_{DS}$	20	V
Gate-Source Voltage	$V_{GS}$	±12	V
Continuous Drain Current	$I_D$	6	A
Pulsed Drain Current	$I_{DM}$	25	A
Power Dissipation	$P_D$	1.5	W
Junction Temperature	$T_J$	-55 ~ +150	°C
Storage Temperature	$T_{STG}$	-55 ~ +150	°C

**Electrical characteristics (T<sub>A</sub>=25 °C, unless otherwise noted)**

Parameter	Symbol	Test Condition	Min.	Typ.	Max.	Unit
<b>Static Characteristics</b>						
Drain-source breakdown voltage	$V_{(BR)DSS}$	$V_{GS} = 0V, I_D = 250\mu A$	20			V
Zero gate voltage drain current	$I_{DSS}$	$V_{DS} = 20V, V_{GS} = 0V$			1	μA
Gate-body leakage current	$I_{GSS}$	$V_{GS} = \pm 12V, V_{DS} = 0V$			±100	nA
Gate threshold voltage	$V_{GS(th)}$	$V_{DS} = V_{GS}, I_D = 250\mu A$	0.5		1.2	V
Drain-source on-resistance <sup>1)</sup>	$R_{DS(on)}$	$V_{GS} = 4.5V, I_D = 6.0A$		18	25	mΩ
		$V_{GS} = 2.5V, I_D = 5.0A$		23	32	
Forward transconductance <sup>1)</sup>	$g_{FS}$	$V_{DS} = 5V, I_D = 7A$	9			S
<b>Dynamic characteristics<sup>2)</sup></b>						
Input Capacitance	$C_{iss}$	$V_{DS} = 8V, V_{GS} = 0V, f = 1MHz$		800		pF
Output Capacitance	$C_{oss}$			155		
Reverse Transfer Capacitance	$C_{rss}$			125		
Total Gate Charge	$Q_g$	$V_{DS} = 10V, V_{GS} = 4.5V, I_D = 4A$		11		nC
Gate-Source Charge	$Q_{gs}$			2.3		
Gate-Drain Charge	$Q_{gd}$			2.5		
Turn-on delay time	$t_{d(on)}$	$V_{DD} = 10V, V_{GS} = 4V, I_D = 1A, R_{GEN} = 10\Omega$		13		nS
Turn-on rise time	$t_r$			54		
Turn-off delay time	$t_{d(off)}$			18		
Turn-off fall time	$t_f$			11		
<b>Source-Drain Diode characteristics</b>						
Diode Forward voltage	$V_{DS}$	$V_{GS} = 0V, I_S = 4.0A$			1.2	V

Notes:

- 1) Pulse Test: Pulse Width < 300μs, Duty Cycle ≤2%.
- 2) Guaranteed by design, not subject to production testing.

## Typical Characteristics

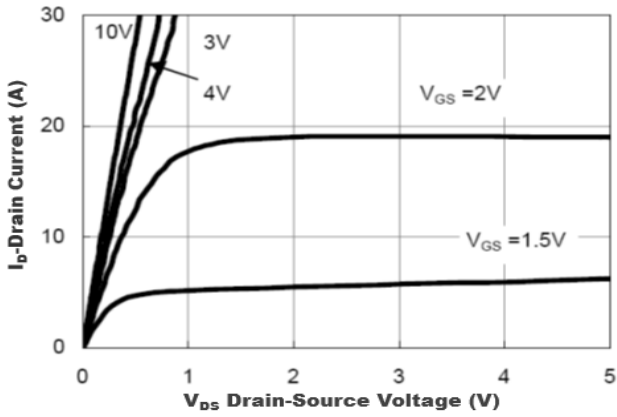

Figure1. Output Characteristics

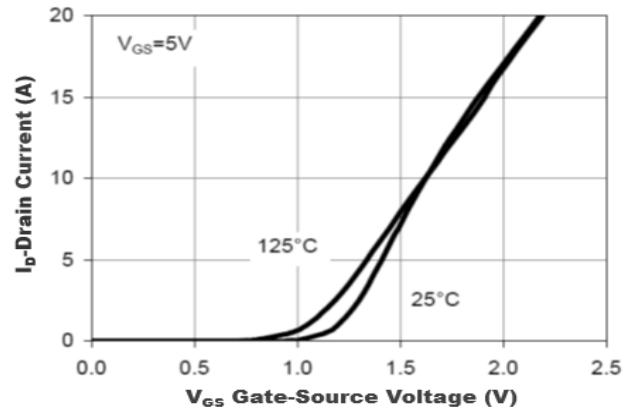

Figure2. Transfer Characteristics

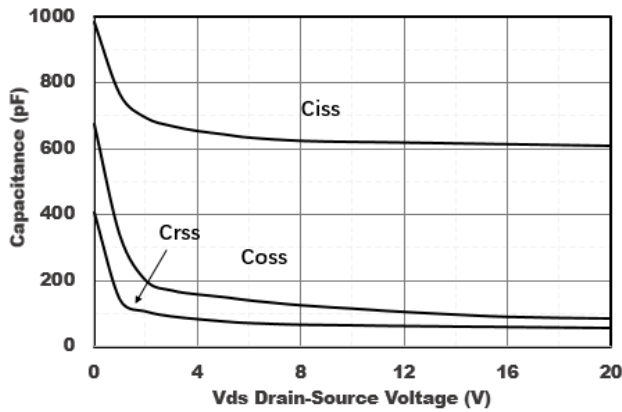

Figure3. Capacitance Characteristics

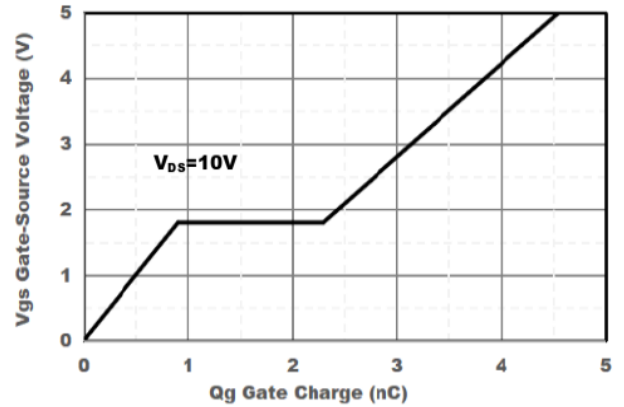

Figure4. Gate Charge

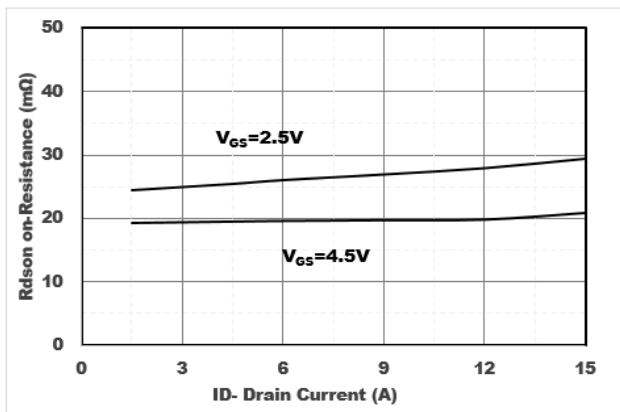

Figure5. Drain-Source on Resistance

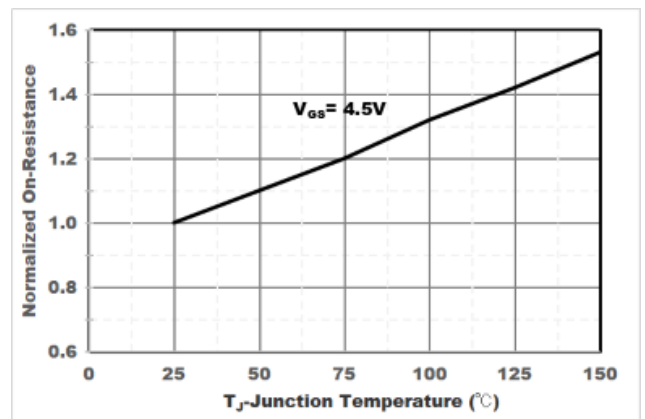
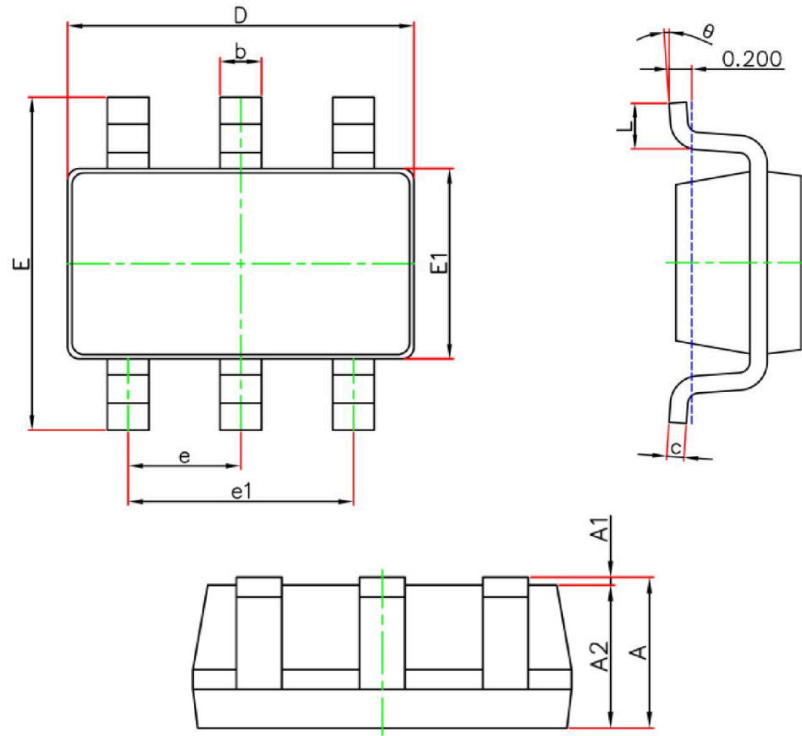

Figure6. Drain-Source on Resistance

## SOT-23-6L Package Information



Symbol	Dimensions In Millimeters		Dimensions In Inches	
	Min.	Max.	Min.	Max.
A	1.050	1.250	0.041	0.049
A1	0.000	0.100	0.000	0.004
A2	1.050	1.150	0.041	0.045
b	0.300	0.500	0.012	0.020
c	0.100	0.200	0.004	0.008
D	2.820	3.020	0.111	0.119
E	2.650	2.950	0.104	0.116
E1	1.500	1.700	0.059	0.067
e	0.950 (BSC)		0.037 (BSC)	
e1	1.800	2.000	0.071	0.079
L	0.300	0.600	0.012	0.024
θ	0°	8°	0°	8°